



Jul. 2019 Ver.5.0
TDK Corporation

Multilayer Diplexer

For LTE

DPX Series 2.0x1.25mm [EIA 0805] TYPE

P/N: **DPX202690DT-4317A1**

DPX202690DT-4317A1

SHAPES AND DIMENSIONS

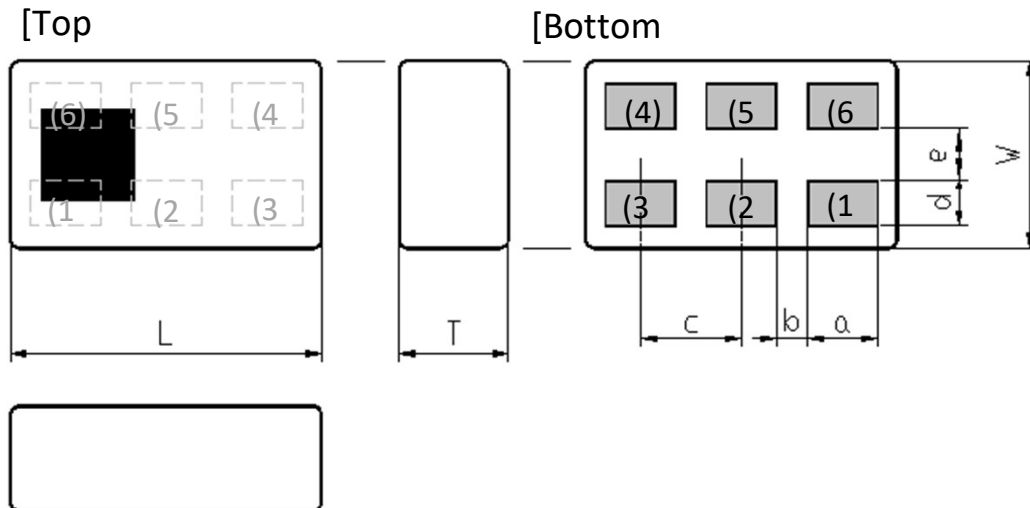

Dimensions (mm)

L	W	T	a	b	c	d	e
2.00	1.25	0.80	0.40	0.25	0.65	0.35	0.30
+/-0.05	+/-0.05	Max	+/-0.05	+/-0.05	+/-0.05	+/-0.05	+/-0.05

Terminal functions

(1)	GND
(2)	Common Port
(3)	GND

(4)	Low-Band Port
(5)	GND
(6)	High-Band Port

TERMINATION FINISH

Material
Ag

DPX202690DT-4317A1

■ ELECTRICAL CHARACTERISTICS

(Measurement)

Low-Band

Parameter	Frequency (MHz)	TDK Spec		
		Min.	Typ.	Max.
Insertion Loss (dB)	617 to 698	-	0.49	0.60
	699 to 758	-	0.49	0.60
	758 to 798	-	0.47	0.55
	798 to 960	-	0.49	0.60
Attenuation (dB)	1554 to 1606	20	25.7	-
	1805 to 1880	35	46.3	-
	2110 to 2200	35	55.6	-
	2620 to 2690	35	45.8	-
	3400 to 3800	35	41.7	-
	5150 to 5925	35	54.6	-
Characteristic Impedance (ohm)		50 (Nominal)		

Ta = +25+/-5°C

High-Band

Parameter	Frequency (MHz)	Request		
		Min.	Typ.	Max.
Insertion Loss (dB)	1452 to 1496	-	0.84	1.20
	1710 to 2200	-	0.41	0.60
	2300 to 2690	-	0.57	0.70
Attenuation (dB)	617 to 960	23	25.5	-
	3400 to 3800	2	7.1	-
	5150 to 5925	28	40.7	-
Characteristic Impedance (ohm)		50 (Nominal)		

Ta = +25+/-5°C

DPX202690DT-4317A1**ELECTRICAL CHARACTERISTICS**

(Measurement)

Common

Parameter	Frequency (MHz)	TDK Spec		
		Min.	Typ.	Max.
Isolation (dB)	617 to 699	20	24.5	-
	699 to 960	20	24.5	-
	1710 to 2200	30	38.3	-
	2300 to 2690	38	45.4	-
	3400 to 3800	38	47.4	-
	5150 to 5925	30	37.2	-
Characteristic Impedance (ohm)		50 (Nominal)		

Ta = +25+/-5°C

MAXIMUM RATINGS

Parameter		TDK Spec		Conditions
		Min.	Max.	
Operating temperature (°C)		-40 to +85 °C		
Storage temperature (°C)		-40 to +85 °C		
Power Handling (W)	Common Port	-	4	CW Duty 50% at 617~960MHz
		-	2	CW Duty 100% at 1710~2690MHz
		-	2	CW Duty 50% at 1452~1496MHz
	Low-Band Port	-	4	CW Duty 50% at 617~960MHz
		-		
	High-Band Port	-	2	CW Duty 100% at 1710~2690MHz
-		2	CW Duty 50% at 1452~1496MHz	
Human Body Model : HBM	@Each Port (V)	-1000	1000	100pF / 1500ohm
Machine Model : MM	@Each Port (V)	-150	150	200pF / 0ohm
Charged Device Model : CDM	@Each Port (V)	-500	500	Relative humidity : 60%RH max Ambient temperature : +25+/-5°C

DPX202690DT-4317A1

FREQUENCY CHARACTERISTICS

Low band-Port

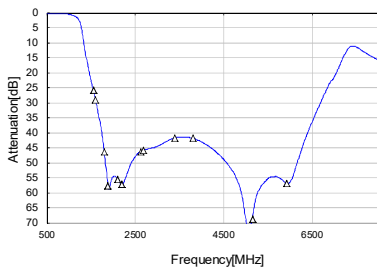

Frequency [MHz]	Attenuation [dB]
1554	25.73
1606	28.99
1805	46.32
1880	57.61
2110	55.56
2200	57.29
2620	46.31
2690	45.78
3400	41.71
3800	41.86
5150	68.73
5925	57.01

High band-Port

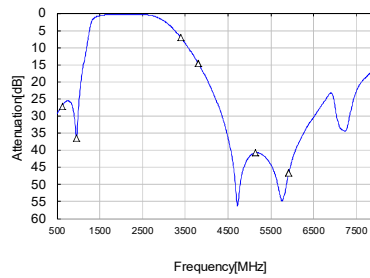

Frequency [MHz]	Attenuation [dB]
617	27.09
960	36.47
3400	7.10
3800	14.55
5150	40.73
5925	46.61

Low band-Port

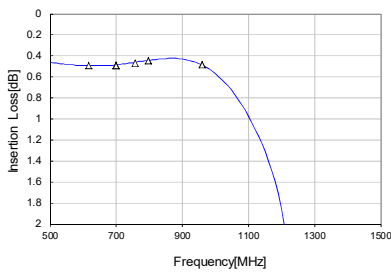

Frequency [MHz]	Insertion Loss [dB]
617	0.49
698	0.49
699	0.49
758	0.47
798	0.45
960	0.49

High band-Port

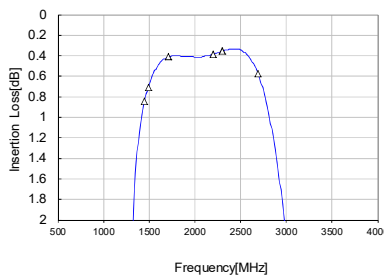

Frequency [MHz]	Insertion Loss [dB]
1452	0.84
1496	0.71
1710	0.41
2200	0.39
2300	0.35
2690	0.57

Common Port Return Loss

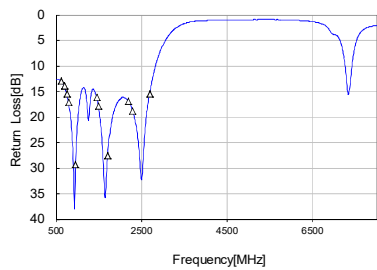

Frequency [MHz]	Return Loss [dB]
617	12.9
698	13.9
1452	16.2
1496	17.9
1710	27.5
2200	16.9
2300	18.9
2690	15.4

Isolation

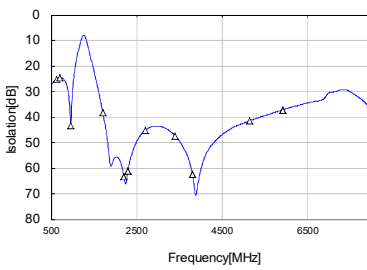

Frequency [MHz]	Isolation [dB]
617	25.3
699	24.5
960	43.3
1710	38.3
2200	63.4
2300	61.0
2690	45.4
3400	47.4
3800	62.3
5150	41.4
5925	37.2

Low band-Port Return Loss

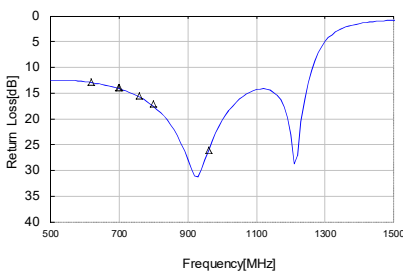

Frequency [MHz]	Return Loss [dB]
617	12.9
698	13.9
699	13.9
758	15.5
798	17.1
960	28.0

High band-Port Return Loss

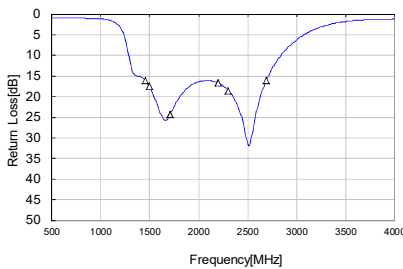

Frequency [MHz]	Return Loss [dB]
1452	16.0
1496	17.4
1710	24.3
2200	16.7
2300	18.5
2690	16.0

DPX202690DT-4317A1

RECOMMENDED LAND PATTERN

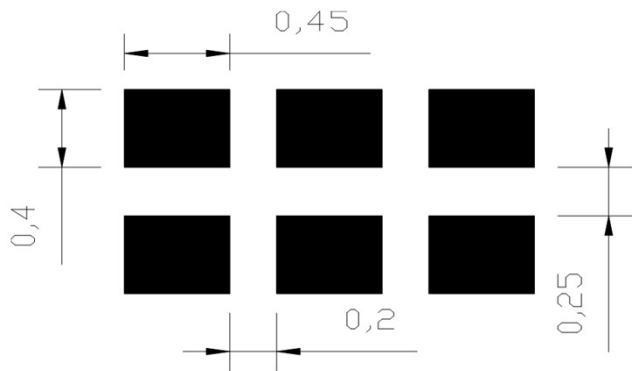

Unit[mm]

EVALUATION BOARD

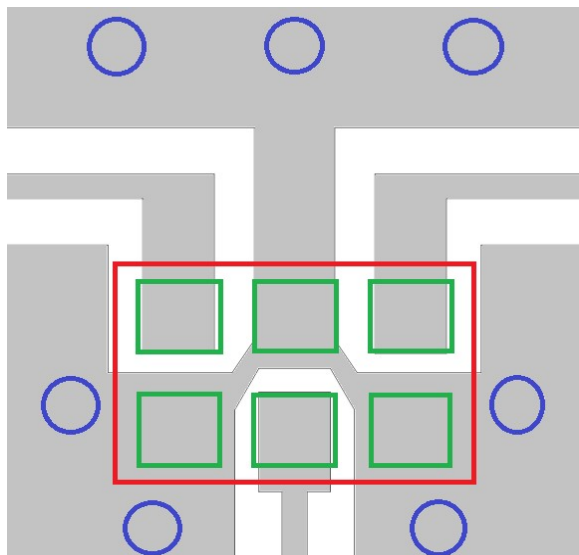

- Thru Hole
- Resist
- Surface Pattern
- DUT

Material & Layer	Thickness
Top Resist	-
Copper Surface Pattern	0.035mm
FR-4	0.10mm
Inner GND	0.018mm
FR-4	0.30mm
Copper Bottom GND	0.035mm

ENVIRONMENT INFORMATION

RoHS Statement
RoHS Compliance

TDK Corporation

RECOMMENDED REFLOW PROFILE

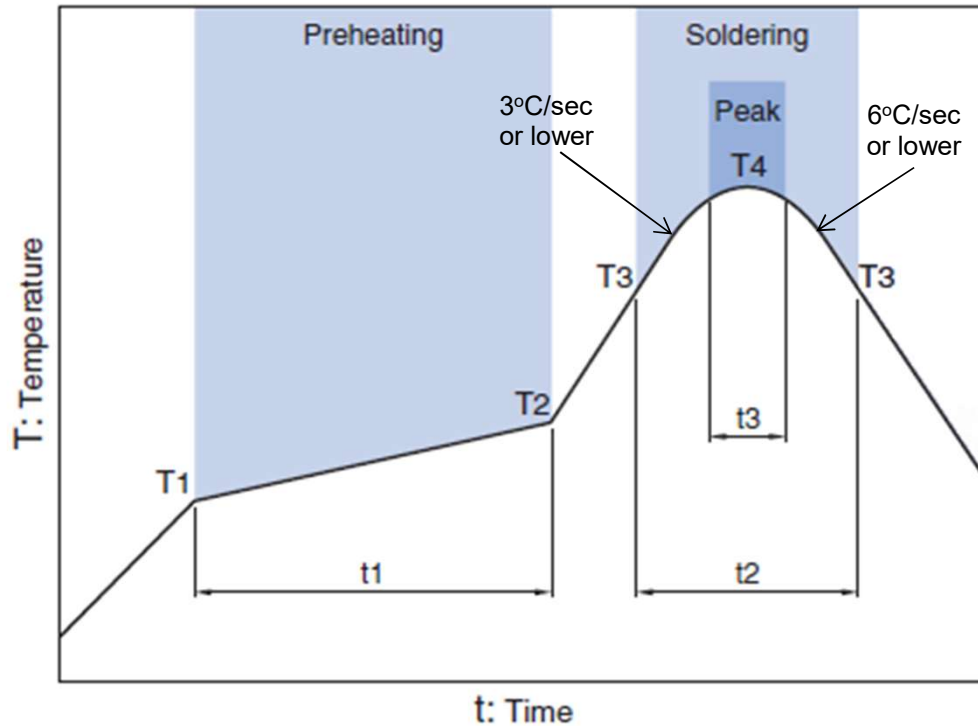

Preheating			Soldering			
Temp.		Time	Critical zone (T3 to T4)		Peak	
T1	T2	t1	T3	t2	T4	t3 *
150°C	200°C	60 to 120sec	217°C	60 to 120sec	240 to 260°C	30 sec Max

* t3 : Time within 5°C of actual peak temperature

The maximum number of reflow is 3.

Note: Lead free solder is recommended.
Recommended solder is Sn-3.0Ag-0.5Cu. (M705 by Senju Metal Industry)

DPX202690DT-4317A1

PACKAGING STYLE

Reel Dimensions

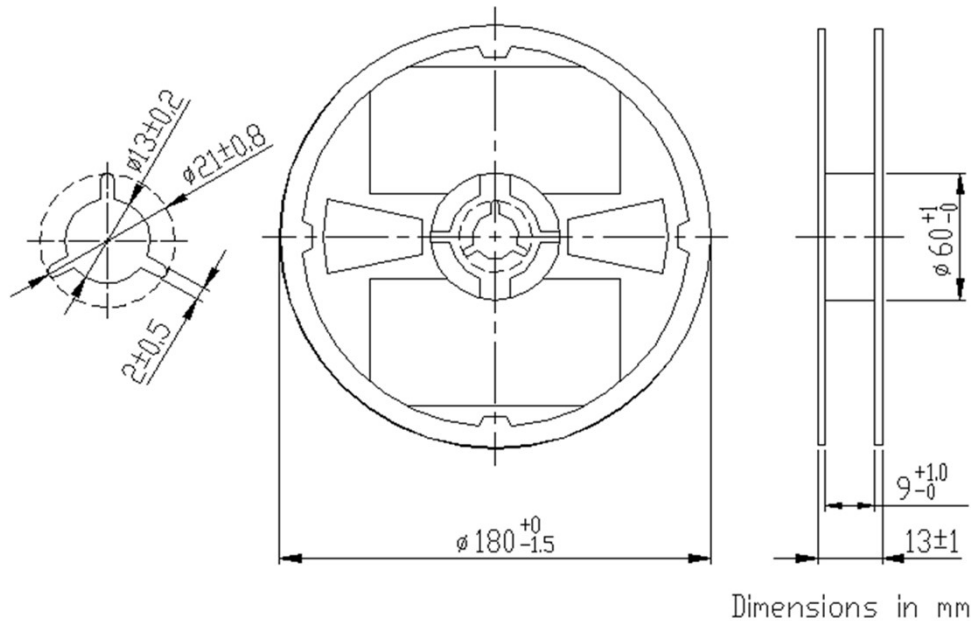

Carrier Tape

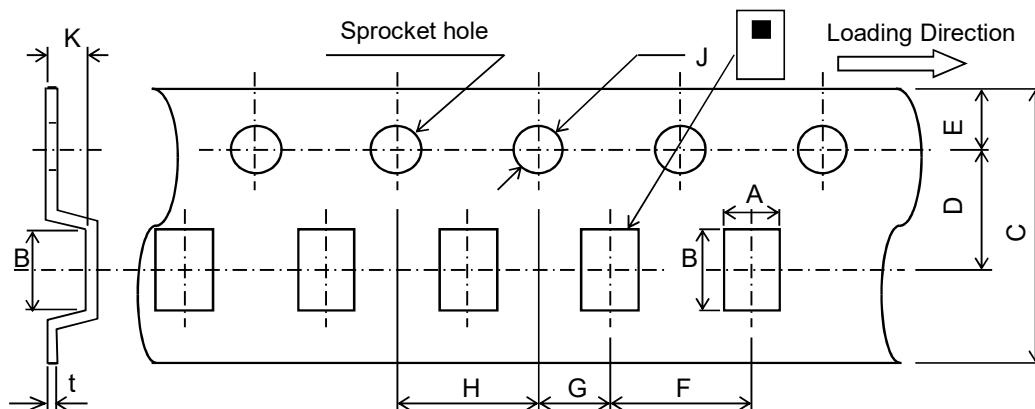

Dimensions (mm)

A	B	C	D	E	F	G	H	J	K	t
1.45	2.2	8.0	3.5	1.75	4.0	2.0	4.0	1.5	0.95	0.25
+/-0.05	+/-0.05	0.3/-0.1	+/-0.05	+/-0.1	+/-0.1	+/-0.05	+/-0.1	+0.1/-0	MAX	+/-0.05

STANDARD PACKAGE QUANTITY (pieces/reel)
2,000

REMINDERS FOR USING THESE PRODUCTS

Before using these products, be sure to request the delivery specifications.

SAFETY REMINDERS

Please pay sufficient attention to the warnings for safe designing when using these products.

 **REMINDERS**

The products listed on this specification sheet are intended for use in general electronic equipment (AV equipment, telecommunications equipment, home appliances, amusement equipment, computer equipment, personal equipment, office equipment, measurement equipment, industrial robots) under a normal operation and use condition.

The products are not designed or warranted to meet the requirements of the applications listed below, whose performance and/or quality require a more stringent level of safety or reliability, or whose failure, malfunction or trouble could cause serious damage to society, person or property. Please understand that we are not responsible for any damage or liability caused by use of the products in any of the applications below or for any other use exceeding the range or conditions set forth in this specification sheet.

1. Aerospace/Aviation equipment
2. Transportation equipment (cars, electric trains, ships, etc.)
3. Medical equipment
4. Power-generation control equipment
5. Atomic energy-related equipment
6. Seabed equipment
7. Transportation control equipment
8. Public information-processing equipment
9. Military equipment
10. Electric heating apparatus, burning equipment
11. Disaster prevention/crime prevention equipment
12. Safety equipment
13. Other applications that are not considered general-purpose applications

When using this product in general-purpose applications, you are kindly requested to take into consideration securing protection circuit/equipment or providing backup circuits, etc., to ensure higher safety.

X-ON Electronics

Largest Supplier of Electrical and Electronic Components

Click to view similar products for [tdk manufacturer](#):

Other Similar products are found below :

[VLF5012ST-1R0N2R5](#) [R14493](#) [SWS1000L-24/BL](#) [CXA-2115](#) [MCZ1210AH301L2T](#) [78P7200-IH/F](#) [MLP2012S1R5TT](#) [ACH3218-682-TD01](#) [ACT45B-KIT](#) [NL565050T-822J-PF](#) [C1005JB1H471K050BA](#) [C1608CH1H151J080AA](#) [C2012JB1H105K125AB](#)
[C4532NP01H154J250KA](#) [CD75-B2GA331KYGKA](#) [CLF10040T-221M](#) [CLF12555T-220M](#) [R22095*REPAIRED](#) [MLF1005LR12K](#)
[VLS252015T-3R3M1R0](#) [VLS4012T-150MR65](#) [ZCAT-KIT](#) [MPZ2012-KIT](#) [NLV32T-R27J-EFD](#) [CGA3EANP02A682J080AC](#)
[CKCM25C0G2A101K060AK](#) [CLF10040T-4R7N](#) [WTM505090-10K2-5V-G1](#) [VLS252010HBX-R24M-1](#) [CGJ2B2X7R1C222K](#)
[CGA9M1X7T2J334K](#) [CGA8P3X7T2E105M/SOFT](#) [CGA6J4C0G2J392J](#) [CGA6M3X7R2E154K](#) [CGA3E3C0G2E181J](#) [CGA2B2C0G1H331J](#)
[C-WPTX01-E6-KIT](#) [CEU-AC01-E6-KIT](#) [CERB3UX5R0G105M](#) [RLF12545T-100M5R1-PF](#) [PFE500F28/T](#) [CCT406393-600-36-02](#)
[PFC3819QM-181K09B-00](#) [VLF3010AT-100MR49](#) [MMZ0603D330C](#) [MPZ2012S102ATD25](#) [MLG0603P-2-KIT](#) [MLG1608B18NJ](#) [UHV-251A](#) [FHV-11AN](#)