



May.2019 Ver.1.5a
TDK Corporation

Multilayer Diplexer

For LTE

DPX Series 2.0x1.25mm [EIA 0805] TYPE

P/N: **DPX205925DT-4213A2**

DPX205925DT-4213A2

SHAPES AND DIMENSIONS

[Top View]

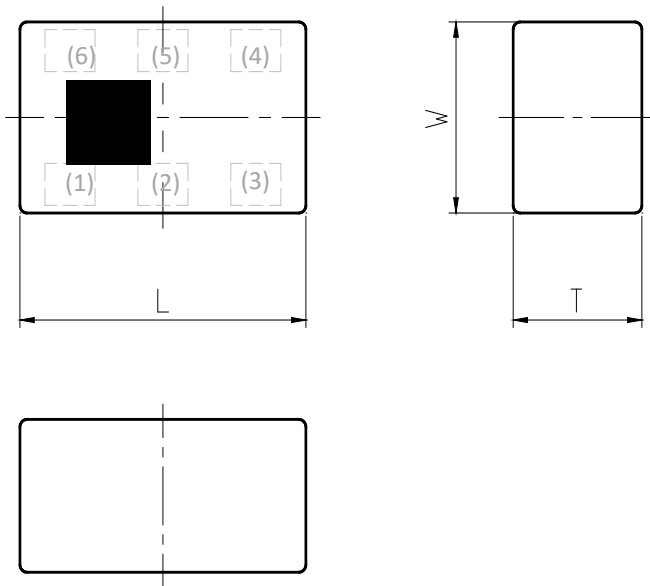

[Bottom View]

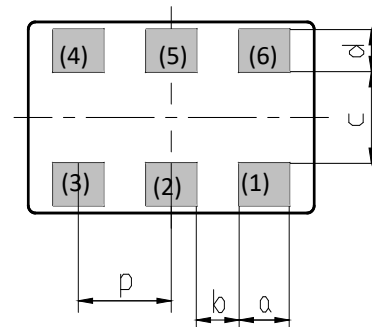

Dimensions (mm)

L	W	T	a	b	c	d	p
2.00	1.25	0.60	0.35	0.30	0.60	0.275	0.65
+/-0.10	+/-0.10	Max	+/-0.10	+/-0.15	+/-0.10	+/-0.10	+/-0.10

Terminal functions

(1)	GND
(2)	Common Port
(3)	GND
(4)	High-Band Port
(5)	GND

(6)	Low-Band Port
-----	---------------

TERMINATION FINISH

Material
Ag

DPX205925DT-4213A2

■ ELECTRICAL CHARACTERISTICS

(Measurement)

Low-Band

Parameter	Frequency (MHz)	TDK Spec.		
		Min.	Typ.	Max.
Insertion Loss (dB)	617 to 960	-	0.17	0.35
	1427 to 1511	-	0.23	0.45
	1710 to 2170	-	0.40	0.55
	2300 to 2496	-	0.58	0.75
	2496 to 2690	-	0.73	0.90
VSWR (Common Port)	617 to 960	-	1.15	1.50
	1427 to 1710	-	1.17	1.50
	1710 to 2170	-	1.31	1.67
	2170 to 2690	-	1.40	1.67
VSWR (Low-Band Port)	617 to 960	-	1.19	1.50
	1427 to 1710	-	1.23	1.50
	1710 to 2170	-	1.30	1.67
	2170 to 2690	-	1.37	1.67
Attenuation (dB)	3300 to 3400	18	26.8	-
	3400 to 3800	23	26.7	-
	5150 to 5925	30	39.9	-

Ta = +25+/-5°C

High-Band

Parameter	Frequency (MHz)	TDK Spec		
		Min.	Typ.	Max.
Insertion Loss (dB)	3300 to 3400	-	0.85	1.30
	3400 to 3800	-	0.73	1.00
	5150 to 5925	-	0.20	0.50
VSWR (Common Port)	3300 to 3400	-	1.23	1.67
	3400 to 3800	-	1.42	1.67
	5150 to 5925	-	1.24	1.50
VSWR (High-Band Port)	3300 to 3400	-	1.27	1.67
	3400 to 3800	-	1.41	1.67
	5150 to 5925	-	1.24	1.50
Attenuation (dB)	617 to 960	30	37.1	-
	1427 to 1511	30	43.1	-
	1710 to 2170	25	29.9	-
	2170 to 2690	22	25.7	-
	10300 to 11850	25	42.5	-
	15450 to 17775	5	13.1	-

Ta = +25+/-5°C

DPX205925DT-4213A2

■ ELECTRICAL CHARACTERISTICS

(Measurement)

Isolation

Parameter	Frequency (MHz)	TDK Spec		
		Min.	Typ.	Max.
Isolation (dB)	617 to 960	30.0	36.6	-
	1427 to 1511	30.0	42.6	-
	1710 to 2170	23.0	31.5	-
	2170 to 2690	23.0	28.6	-
	3300 to 3400	20.0	26.4	-
	3400 to 3800	23.0	27.6	-
	5150 to 5925	28.0	39.3	-

Ta = +25+/-5°C

■ MAXIMUM RATINGS

Parameter		TDK Spec	Conditions	
Operating temperature (°C)		-40 to +85 °C		
Storage temperature (°C)		-40 to +85 °C		
Power Handling (W) *1	Low-Band	Frequency (MHz)		
		617 to 960	4	GSM signal Duty 50%
		1427 to 2690	1	CW
	High-Band	to		CW
		3300 to 5925	1	CW
		to		CW
Human Body Model : HBM	@Each Port (V)	+/-1000	100pF / 1500ohm	
Machine Model : MM	@Each Port (V)	+/-150	200pF / 0ohm	
Charged Device Model : CDM	@Each Port (V)	+/-500	Humidity : 60%RH max	

*1 : Refer to 3GPP TS 38.101-1 V15.2.0

DPX205925DT-4213A2

FREQUENCY CHARACTERISTICS

ANT - LOW

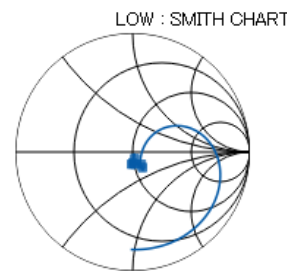
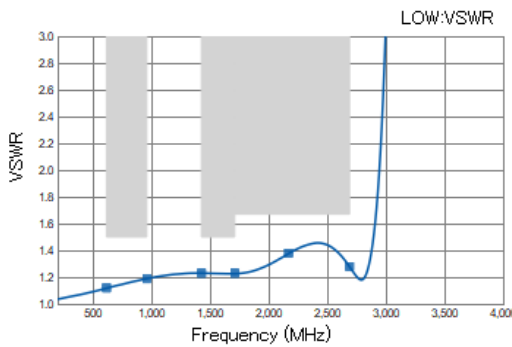
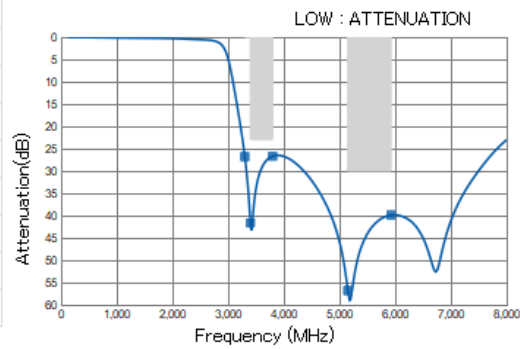
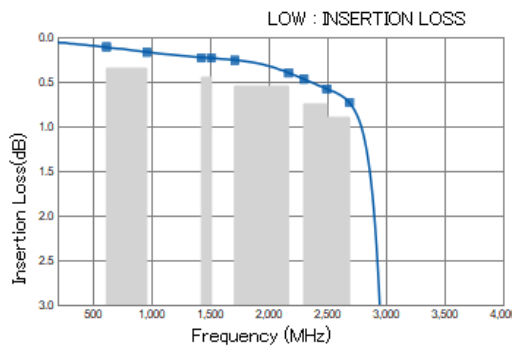

DPX205925DT-4213A2

FREQUENCY CHARACTERISTICS

ANT - HIGH

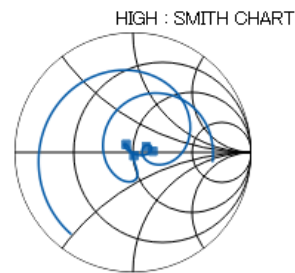
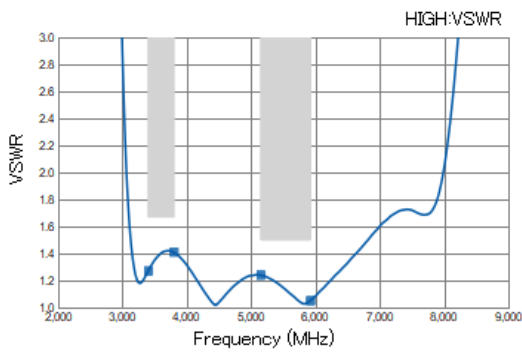
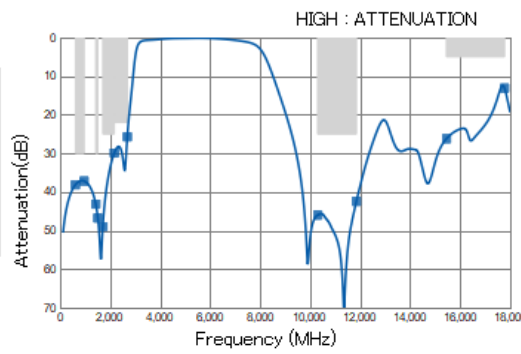
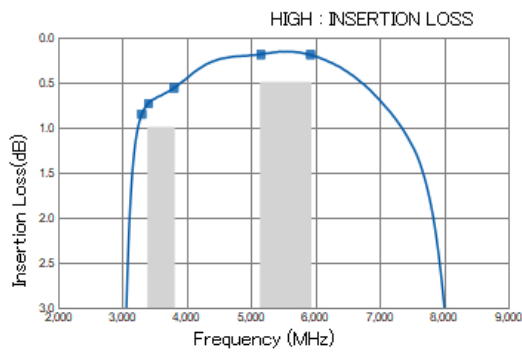

DPX205925DT-4213A2

■ FREQUENCY CHARACTERISTICS

COMMON

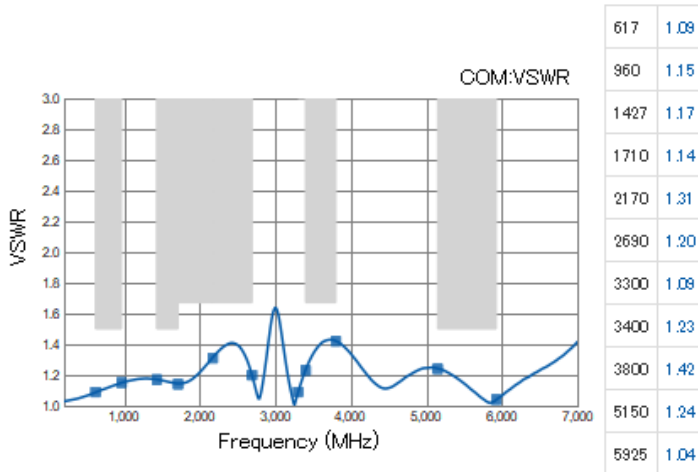

ISOLATION

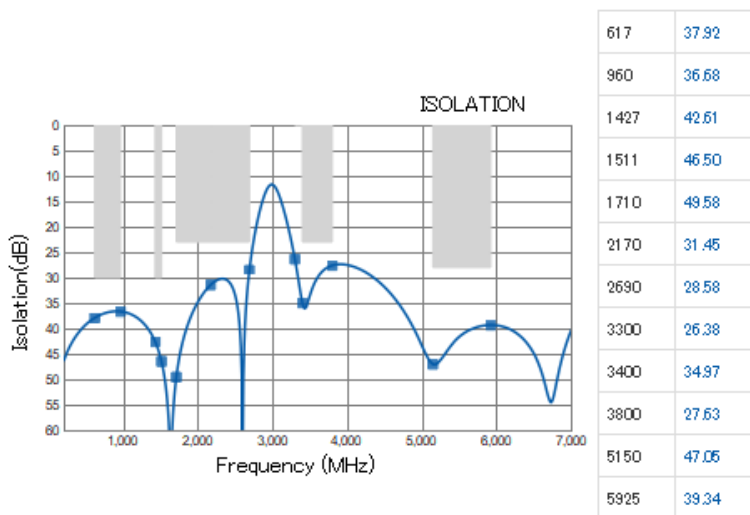

DPX205925DT-4213A2

RECOMMENDED LAND PATTERN

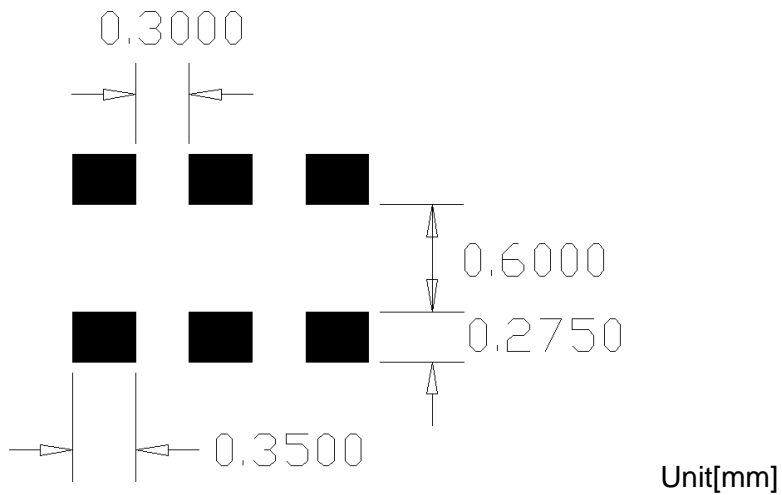

EVALUATION BOARD

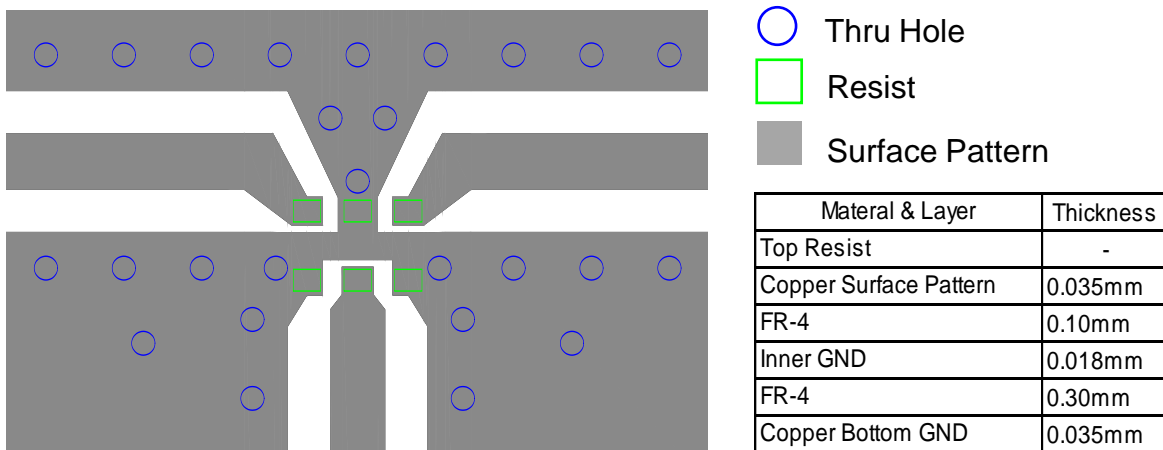

* Line width should be designed to match 50 ohm characteristic impedance depending on PCB material and thickness.

ENVIRONMENT INFORMATION

RoHS Statement
RoHS Compliance

DPX205925DT-4213A2

RECOMMENDED REFLOW PROFILE

Pb free solder

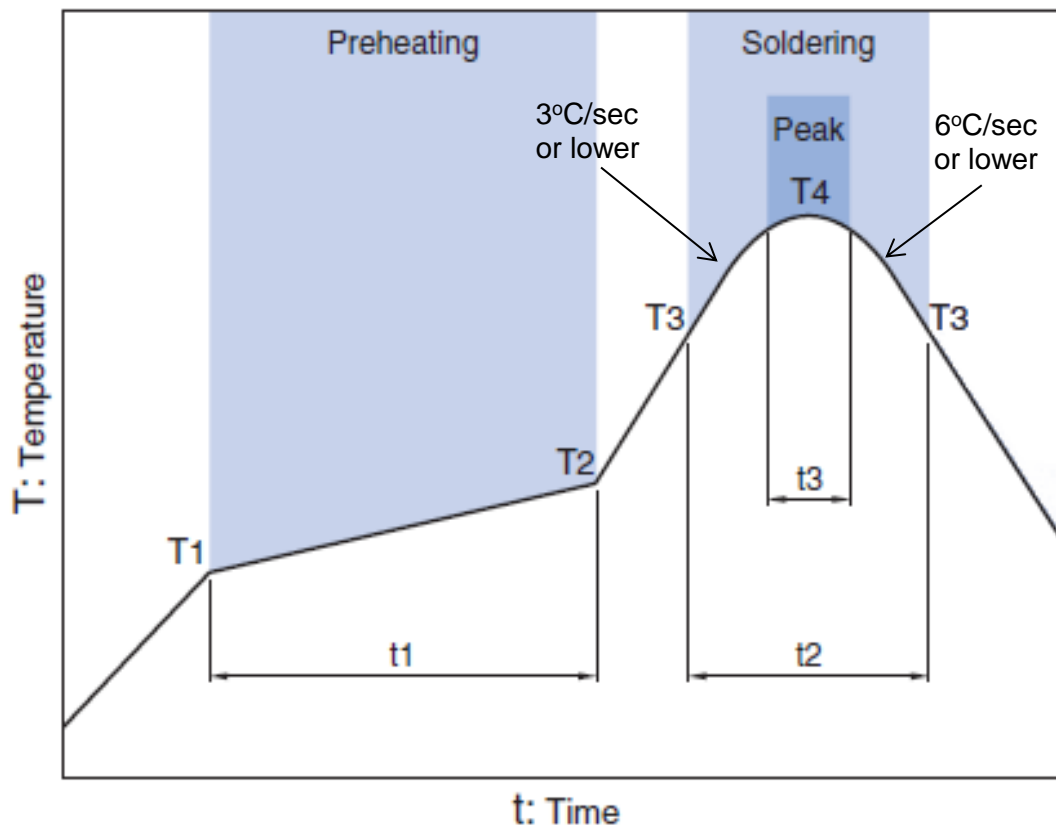

Preheating			Soldering			
Temp.		Time	Critical zone (T3 to T4)		Peak	
T1	T2	t1	T3	t2	T4	t3 *
150°C	200°C	60 to 120sec	217°C	60 to 120sec	240 to 260°C	30 sec Max

* t3 : Time within 5°C of actual peak temperature

The maximum number of reflow is 3.

Note: Lead free solder is recommended.
Recommended solder is Sn-3.0Ag-0.5Cu. (M705 by Senju Metal Industry)

DPX205925DT-4213A2

PACKAGING STYLE

Reel Dimensions

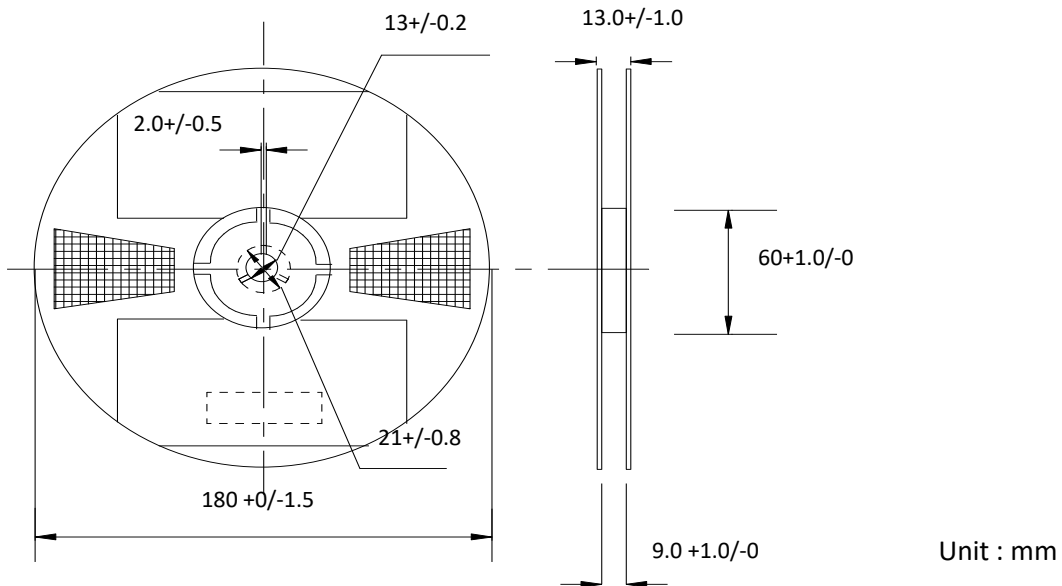

Carrier Tape

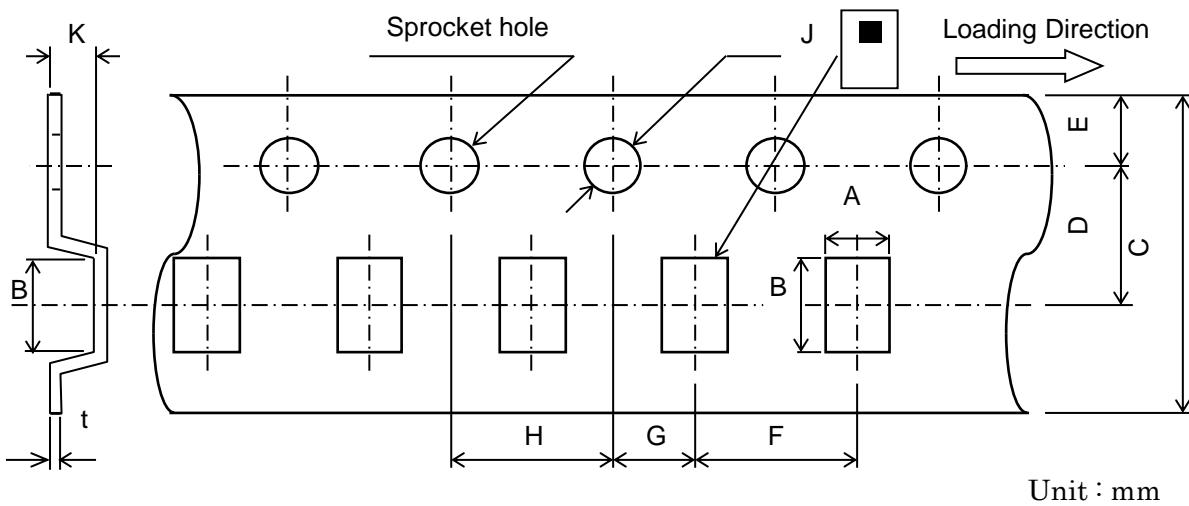

Dimensions (mm)

A	B	C	D	E	F	G	H	J	K	t
1.45	2.2	8.0	3.5	1.75	4.0	2.0	4.0	1.5	0.8	0.25
+/-0.05	+/-0.05	+0.3/-0.1	+/-0.05	+/-0.1	+/-0.1	+/-0.05	+/-0.1	+0.1/-0	MAX	+/-0.05

STANDARD PACKAGE QUANTITY (pieces/reel)
2,000

REMINDERS FOR USING THESE PRODUCTS

Before using these products, be sure to request the delivery specifications.

SAFETY REMINDERS

Please pay sufficient attention to the warnings for safe designing when using these products.

 REMINDERS
--

The products listed on this specification sheet are intended for use in general electronic equipment (AV equipment, telecommunications equipment, home appliances, amusement equipment, computer equipment, personal equipment, office equipment, measurement equipment, industrial robots) under a normal operation and use condition.

The products are not designed or warranted to meet the requirements of the applications listed below, whose performance and/or quality require a more stringent level of safety or reliability, or whose failure, malfunction or trouble could cause serious damage to society, person or property. Please understand that we are not responsible for any damage or liability caused by use of the products in any of the applications below or for any other use exceeding the range or conditions set forth in this specification sheet.

1. Aerospace/Aviation equipment
2. Transportation equipment (cars, electric trains, ships, etc.)
3. Medical equipment
4. Power-generation control equipment
5. Atomic energy-related equipment
6. Seabed equipment
7. Transportation control equipment
8. Public information-processing equipment
9. Military equipment
10. Electric heating apparatus, burning equipment
11. Disaster prevention/crime prevention equipment
12. Safety equipment
13. Other applications that are not considered general-purpose applications

When using this product in general-purpose applications, you are kindly requested to take into consideration securing protection circuit/equipment or providing backup circuits, etc., to ensure higher safety.

X-ON Electronics

Largest Supplier of Electrical and Electronic Components

Click to view similar products for [TDK manufacturer](#):

Other Similar products are found below :

[99900040](#) [99900053](#) [ACB1608M-120-T/10](#) [ACF321825-102-TD01](#) [ACF321825-152-TD01](#) [ACF321825-220-TD01](#) [ACF321825-221-TD01](#)
[ACF321825-330-TD01](#) [ACF321825-332-TD01](#) [ACF321825-472-TD01](#) [ACF321825-680-TD01](#) [ACF321825-681-TD01](#) [ACF321825-682](#)
[ACF321825-682-TD01](#) [ACF451832-151-TD01](#) [ACF451832-152-TD01](#) [ACF451832-153-TD01](#) [ACF451832-331-TD01](#) [ACF451832-333-](#)
[TD01](#) [ACF451832-470-TD01](#) [ACF451832-472-TD01](#) [ACF451832-680-TD01](#) [ACH3218-220-TD01](#) [ACH3218-222-TD01](#) [ACH3218-330-](#)
[TD01](#) [ACH3218-331-TD01](#) [ACH3218-332-TD01](#) [ACH3218-470-TD01](#) [ACH3218-682-TD01](#) [ACH4518-153-TD01](#) [ACH4518-220-TD01](#)
[ACH4518-331-TD01](#) [ACH4518-332-TD01](#) [ACH4518-472-TD01](#) [ACH4518-680-TD01](#) [ACM1211-102-2PL-TL01](#) [ACM1211-701-2PL-TL01](#)
[ACM12V-172-2PL-TL00](#) [ACM12V-701-2PL-TL00](#) [ACM1513-551-2PL-T](#) [ACM1513-551-2PL-TLHF](#) [ACM2012-102-2P-T001](#) [ACM2012-](#)
[121-2P-T001](#) [ACM2012-121-2P-T002](#) [ACM2012-201-2P](#) [ACM2012-201-2P-T](#) [ACM2012-201-2P-T001](#) [ACM2012-201-2P-T002](#)
[ACM2012-202-2P-T002](#) [ACM2012-222-2P-T001](#)