

## Bottom Port PDM Digital Output Multi-Mode Microphone

### GENERAL DESCRIPTION

The T5838 is a multi-mode, low noise digital MEMS microphone in a small package. The T5838 consists of a MEMS microphone element and an impedance converter amplifier followed by a fifth order  $\Sigma$ - $\Delta$  modulator. The digital interface allows the pulse density modulated (PDM) output of two microphones to be time multiplexed on a single data line using a single clock.

The T5838 has multiple modes of operation: High Quality, Low-Power (AlwaysOn), Ultrasonic, and Sleep along with new AlwaysOn modes: Acoustic Activity Detect (AAD) Analog and Digital. The T5838 has high SNR in all operational modes. It has 133 dB SPL AOP in High Quality Mode and 119 dB SPL AOP in Low-Power mode.

The T5838 is available in a standard  $3.5 \times 2.65 \times 0.98$  mm surface-mount package. It is reflow solder compatible with no sensitivity degradation.

### APPLICATIONS

- Smartphones
- IP Cameras
- Voice Activated TV Remote Controls
- Microphone Arrays
- Tablet Computers
- Cameras

### FEATURES

SPEC	HIGH QUALITY MODE	LOW-POWER MODE	ULTRASONIC MODE
<b>Sensitivity</b>	-41 dB FS $\pm$ 1 dB	-26 dB FS $\pm$ 1 dB	-41 dB FS $\pm$ 1 dB
<b>SNR</b>	68 dBA	65 dBA	68dBA
<b>Current</b>	310 $\mu$ A	120 $\mu$ A	500 $\mu$ A
<b>AOP</b>	133 dB SPL	119 dB SPL	133 dB SPL
<b>Clock</b>	2.0 MHz to 3.7 MHz	400 kHz to 800 kHz	4.2 MHz to 4.8 MHz

- $3.5 \times 2.65 \times 0.98$  mm surface-mount package
- Extended frequency response from 27 Hz to >20 kHz
- Sleep Mode: 9  $\mu$ A
- Acoustic Activity Detect Modes including AAD Analog: 20uA
- Fifth order  $\Sigma$ - $\Delta$  modulator
- Digital pulse density modulation (PDM) output
- Compatible with Sn/Pb and Pb-free solder processes
- RoHS/WEEE compliant

### FUNCTIONAL BLOCK DIAGRAM

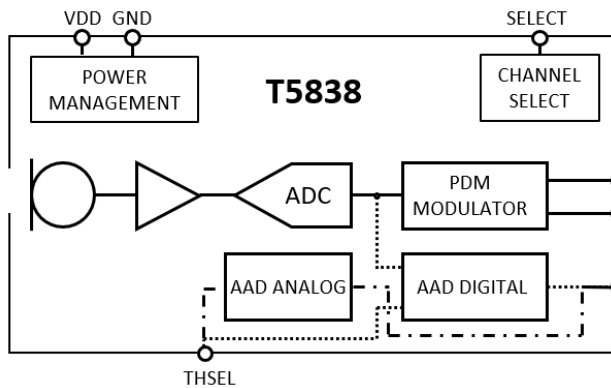

### ORDERING INFORMATION

PART	TEMP RANGE	PACKAGING
MMICT5838-00-012	-40°C to +85°C	13" Tape and Reel
EV_T5838-FX2		Flex Evaluation Board

## TABLE OF CONTENTS

General Description .....	1
Applications .....	1
Features .....	1
Functional Block Diagram .....	1
Ordering Information .....	1
Table of Contents .....	2
1.Specifications.....	5
1.1. Acoustical/Electrical Characteristics – General .....	5
1.2. Acoustical/Electrical Characteristics – High Quality Mode .....	5
1.3. Acoustical/Electrical Characteristics – Low-Power Mode .....	6
1.4. Acoustical/Electrical Characteristics – Ultrasonic Mode .....	6
1.5. Acoustical/Electrical Characteristics – AAD Modes .....	6
1.6. Digital Input/Output Characteristics .....	7
1.7. PDM Digital Input/Output .....	7
1.8. Timing Diagram .....	8
2.Absolute Maximum Ratings.....	9
2.1. Table 8. Absolute Maximum Ratings.....	9
2.2. ESD Caution .....	9
2.3. Soldering Profile .....	10
2.4. Recommended Soldering Profile* .....	10
3.Pin Configurations And Function Descriptions .....	11
3.1. Pin Function Descriptions.....	11
4.Typical Performance Characteristics .....	12
5.Modes Of Operation .....	14
5.1. Existing Microphone Modes.....	14
5.2. Acoustic Activity Detect Microphone Modes .....	14
5.3. AAD Modes and Description .....	15
5.4. Acoustic Activity Detect Analog .....	15
5.5. Acoustic Activity Detect Digital 1 .....	16
5.6. Acoustic Activity Detect Digital 2 .....	16
5.7. Mode Selection and Mode Changes before AAD Activation .....	16
5.8. AAD Status And Disable.....	16
5.9. Acoustic Activity Detect Configuration Protocol .....	17
5.10. One Wire Serial Protocol Symbols.....	17
5.1. Example One Wire Write.....	18
5.2. AAD Enable Sequence .....	19

- 5.3. AAD Enable Sequence Writes..... 19
- 5.4. Acoustic Activity Detect Analog (AAD A) Operation and Configuration..... 19
- 5.5. AAD A Registers..... 20
- 5.6. AAD A LPF Values ..... 20
- 5.7. AAD A TH Values..... 21
- 5.8. AAD A Example Configuration and Activation Sequence ..... 21
- 5.9. AAD A Register Map ..... 22
- 5.10. Acoustic Activity Detect Digital (AAD D) Operation and Configuration..... 22
- 5.11. AAD D Registers..... 22
- 5.12. Threshold Algorithms ..... 23
- 5.13. Absolute Threshold Algorithm ..... 23
- 5.14. Absolute Threshold Values ..... 23
- 5.15. Relative Threshold Algorithm..... 24
- 5.16. Relative Threshold Values ..... 24
- 5.17. Floor Values ..... 25
- 5.18. Minimum Pulse Duration Time..... 25
- 5.19. Minimum Pulse Duration Time Values ..... 26
- 5.20. AAD D1 Example Configuration And Activation Sequence ..... 26
- 5.21. AAD D2 Example Configuration And Activation Sequence ..... 27
- 5.22. AAD D Register Map ..... 28
- 6.Theory Of Operation..... 28
  - 6.1. PDM Data Format..... 28
  - 6.2. Channel Setting ..... 29
  - 6.3. PDM Microphone Sensitivity..... 29
- 7.Applications Information ..... 31
  - 7.1. Low-Power Mode ..... 31
  - 7.2. Dynamic Range Considerations ..... 31
  - 7.3. Connecting PDM Microphones ..... 31
  - 7.4. Sleep Mode ..... 33
  - 7.5. Start-Up Time ..... 33
- 8.Supporting Documents..... 34
  - 8.1. Application Notes – General ..... 34
- 9.PCB Design And Land Pattern Layout ..... 35
  - 9.1. PCB Material And Thickness ..... 36
- 10.Handling Instructions..... 36
  - 10.1. Pick And Place Equipment ..... 36
  - 10.2. Reflow Solder ..... 36

---

10.3. Board Wash .....	36
11.Outline Dimensions .....	37
11.1. Ordering Guide .....	37
11.2. Revision History .....	38
12.Compliance Declaration Disclaimer .....	39

## 1. SPECIFICATIONS

### 1.1. ACOUSTICAL/ELECTRICAL CHARACTERISTICS – GENERAL

T<sub>A</sub> = 25°C, V<sub>DD</sub> = 1.8 V, SCK = 2.4 MHz, C<sub>LOAD</sub> = 30 pF unless otherwise noted. Typical specifications are not guaranteed.

PARAMETER	CONDITIONS	MIN	TYP	MAX	UNITS	NOTES
<b>PERFORMANCE</b>						
Directionality		Omni				
Output Polarity	Input acoustic pressure vs. output data	Non-Inverted				
Supply Voltage (V <sub>DD</sub> )		1.62	1.8	1.98	V	
Sleep Mode Current (I <sub>s</sub> )	SCK < 200 kHz		9		μA	
	SCK = OFF		0.8		μA	

**Table 1. Acoustic/Electrical Characteristics – General**

### 1.2. ACOUSTICAL/ELECTRICAL CHARACTERISTICS – HIGH QUALITY MODE

T<sub>A</sub> = 25°C, V<sub>DD</sub> = 1.8 V, SCK = 2.4 MHz, C<sub>LOAD</sub> = 30 pF unless otherwise noted. Typical specifications are not guaranteed.

PARAMETER	CONDITIONS	MIN	TYP	MAX	UNITS	NOTES
Sensitivity	1 kHz, 94 dB SPL	-42	-41	-40	dB FS	1
Signal-to-Noise Ratio (SNR)	20 kHz bandwidth, A-weighted		68		dB	
Equivalent Input Noise (EIN)	20 kHz bandwidth, A-weighted		26		dB SPL	
Acoustic Dynamic Range	Derived from EIN and acoustic overload point		107		dB	
Total Harmonic Distortion (THD)	94 dB SPL		0.1		%	
Low Frequency Roll Off	-3dB, relative to 1kHz Sensitivity		27		Hz	
Power Supply Rejection Ratio (PSRR)	20 Hz, 100 mVpp applied to V <sub>DD</sub>		-86		dB FS(A)	
	1 kHz, 100 mVpp applied to V <sub>DD</sub>		-122			
	5 kHz, 100 mVpp applied to V <sub>DD</sub>		-112			
	10 kHz, 100 mVpp applied to V <sub>DD</sub>		-104			
	20 kHz, 100 mVpp applied to V <sub>DD</sub>		-106			
Power Supply Rejection (PSR)	217 Hz, 100 mV p-p square wave superimposed on V <sub>DD</sub> = 1.8 V, A-weighted		-112		dB FS (A)	
Power Supply Rejection—Swept Sine	1 kHz sine wave		-122		dB FS	
Acoustic Overload Point	10% THD		133		dB SPL	
Supply Current (I <sub>s</sub> )	V <sub>DD</sub> = 1.8 V, no load		310	340	μA	

**Note 1:** Sensitivity is relative to the RMS level of a sine wave with positive amplitude equal to 100% 1s density and negative amplitude equal to 0% 1s density.

**Table 2. Acoustic/Electrical Characteristics – High Quality Mode**

### 1.3. ACOUSTICAL/ELECTRICAL CHARACTERISTICS – LOW-POWER MODE

T<sub>A</sub> = 25°C, VDD = 1.8 V, SCK = 768 kHz, C<sub>LOAD</sub> = 30 pF unless otherwise noted. Typical specifications are not guaranteed.

PARAMETER	CONDITIONS	MIN	TYP	MAX	UNITS	NOTES
Sensitivity	1 kHz, 94 dB SPL	-27	-26	-25	dB FS	1
Signal-to-Noise Ratio (SNR)	8 kHz bandwidth, A-weighted		65		dBA	
Equivalent Input Noise (EIN)	8 kHz bandwidth, A-weighted		29		dBA SPL	
Acoustic Dynamic Range	Derived from EIN and acoustic overload point		90		dB	
Total Harmonic Distortion (THD)	105 dB SPL		0.1		%	
Power Supply Rejection (PSR)	217 Hz, 100 mV p-p square wave superimposed on VDD = 1.8 V, A-weighted		-98		dB FS	
Power Supply Rejection—Swept Sine	1 kHz sine wave		-107		dB FS	
Acoustic Overload Point	10% THD		119		dB SPL	
Supply Current (I <sub>S</sub> )	V <sub>DD</sub> = 1.8 V, no load		120	140	μA	

**Note 1:** Sensitivity is relative to the RMS level of a sine wave with positive amplitude equal to 100% 1s density and negative amplitude equal to 0% 1s density.

**Table 3. Acoustic/Electrical Characteristics – Low Power Mode**

### 1.4. ACOUSTICAL/ELECTRICAL CHARACTERISTICS – ULTRASONIC MODE

T<sub>A</sub> = 25°C, VDD = 1.8 V, SCK = 4.8 MHz, C<sub>LOAD</sub> = 30 pF unless otherwise noted. Typical specifications are not guaranteed.

PARAMETER	CONDITIONS	MIN	TYP	MAX	UNITS	NOTES
Sensitivity	1 kHz, 94 dB SPL	-42	-41	-40	dB FS	1
Signal-to-Noise Ratio (SNR)	20 kHz bandwidth, A-weighted		68		dBA	
Equivalent Input Noise (EIN)	20 kHz bandwidth, A-weighted		26		dBA SPL	
Acoustic Dynamic Range	Derived from EIN and acoustic overload point		107		dB	
Total Harmonic Distortion (THD)	94 dB SPL		0.1		%	
Low Frequency Roll Off	-3dB, relative to 1kHz Sensitivity		27		Hz	
Power Supply Rejection (PSR)	217 Hz, 100 mV p-p square wave superimposed on VDD = 1.8 V, A-weighted		-112		dB FS (A)	
Power Supply Rejection—Swept Sine	1 kHz sine wave		-123		dB FS	
Acoustic Overload Point	10% THD		133		dB SPL	
Supply Current (I <sub>S</sub> )	V <sub>DD</sub> = 1.8 V, no load		500		μA	

**Note 1:** Sensitivity is relative to the RMS level of a sine wave with positive amplitude equal to 100% 1s density and negative amplitude equal to 0% 1s density.

**Table 4. Acoustic/Electrical Characteristics – Ultrasonic Mode**

### 1.5. ACOUSTICAL/ELECTRICAL CHARACTERISTICS – AAD MODES

T<sub>A</sub> = 25°C, VDD = 1.8 V, SCK = OFF, C<sub>LOAD</sub> = 30 pF unless otherwise noted. Typical specifications are not guaranteed.

PARAMETER	CONDITIONS	MIN	TYP	MAX	UNITS	NOTES
<b>AAD ANALOG PARAMETERS</b>						
Min AAD Analog Threshold	1kHz Level, AAD A_TH [3:0] = 0x0;		60		dB SPL	
Max AAD Analog Threshold	1kHz Level, AAD A_TH [3:0] = 0xF;		97.5		dB SPL	
AAD A Supply Current (I <sub>S</sub> )	CLK OFF		20		μA	
<b>AAD DIGITAL PARAMETERS</b>						
Min AAD Digital Absolute Threshold	230Hz Level, AADD_TH [12:0] = 0x00F;		40		dB SPL	
Max AAD Digital Absolute Threshold	230Hz Level, AADD_TH [12:0] = 0x7BC;		87		dB SPL	
AAD D1 Supply Current (I <sub>S</sub> )	CLK = 768kHz		137		μA	
AAD D2 Supply Current (I <sub>S</sub> )	CLK OFF		110		μA	

**Table 5. Acoustic/Electrical Characteristics –AAD Modes**

### 1.6. DIGITAL INPUT/OUTPUT CHARACTERISTICS

T<sub>A</sub> = 25°C, V<sub>DD</sub> = 1.8 V, unless otherwise noted.

PARAMETER	CONDITIONS	MIN	TYP	MAX	UNITS	NOTES
Input Voltage High (V <sub>IH</sub> )		0.65 × V <sub>DD</sub>			V	
Input Voltage Low (V <sub>IL</sub> )				0.35 × V <sub>DD</sub>	V	
Output Voltage High (V <sub>OH</sub> )	I <sub>LOAD</sub> = 0.5 mA	0.7 × V <sub>DD</sub>	V <sub>DD</sub>		V	
Output Voltage Low (V <sub>OL</sub> )	I <sub>LOAD</sub> = 0.5 mA		0	0.3 × V <sub>DD</sub>	V	
Output DC Offset	Percent of full scale		3		%	

Table 6. Digital Input/Output Characteristics

### 1.7. PDM DIGITAL INPUT/OUTPUT

T<sub>A</sub> = 25°C, V<sub>DD</sub> = 1.8 V, unless otherwise noted.

PARAMETER	CONDITIONS	MIN	TYP	MAX	UNITS	NOTES
<b>MODE SWITCHING</b>						
Sleep Time	Time from f <sub>CLK</sub> falling <200 kHz		1		ms	
Wake-Up Time	High Quality mode, Sleep Mode to f <sub>CLK</sub> >2 MHz, output within 0.5 dB of final sensitivity, power on		6		ms	
Wake-Up Time	Low-Power Mode, Sleep Mode to f <sub>CLK</sub> >400 kHz, output within 0.5 dB of final sensitivity, power on		6		ms	
Switching time	Between Low-Power and High Quality Mode		3.5		ms	
<b>INPUT</b>						
t <sub>CLKIN</sub>	Input clock period	208		2500	ns	
Clock Frequency (CLK)	AAD Write Operation	50			kHz	
	Sleep Mode			200	kHz	
	Low-Power Mode	400		800	kHz	
	High Quality Mode	2.0		3.7	MHz	
	Ultrasonic Mode	4.2		4.8	MHz	
Clock Duty Cycle	f <sub>CLK</sub> <4.8 MHz	45		55	%	
t <sub>RISE</sub>	CLK rise time (10% to 90% level)			25	ns	1
t <sub>FALL</sub>	CLK fall time (90% to 10% level)			25	ns	1
<b>OUTPUT</b>						
t <sub>1OUTEN</sub>	DATA1 (right) driven after falling clock edge	30		70	ns	
t <sub>1OUTDIS</sub>	DATA1 (right) disabled after rising clock edge	5		18	ns	
t <sub>2OUTEN</sub>	DATA2 (left) driven after rising clock edge	30		70	ns	
t <sub>2OUTDIS</sub>	DATA2 (left) disabled after falling clock edge	5		18	ns	

Note 1: Guaranteed by design

Table 7. PDM Digital Input/Output

**1.8. TIMING DIAGRAM**

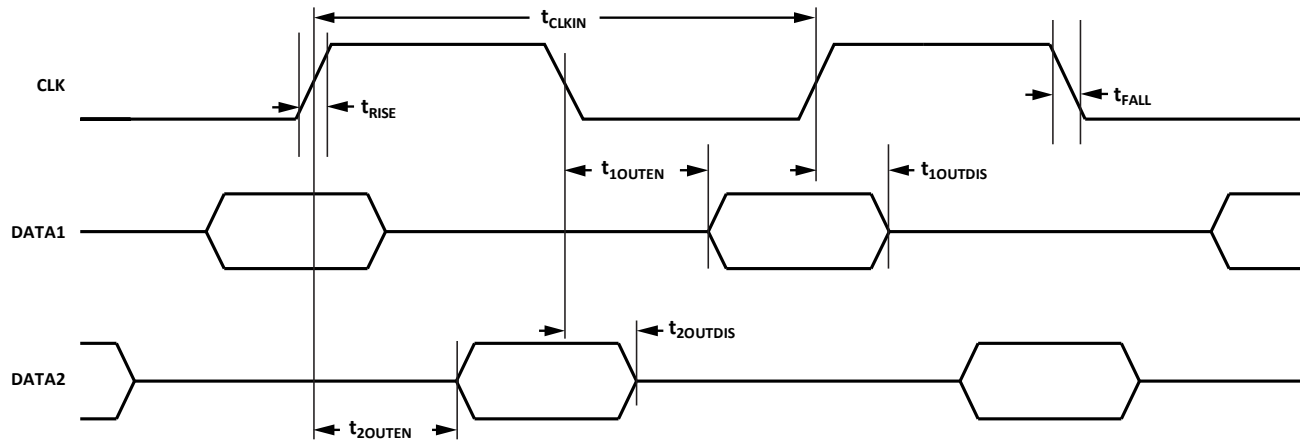

**Figure 1. Pulse Density Modulated Output Timing**



## 2. ABSOLUTE MAXIMUM RATINGS

Stress above those listed as Absolute Maximum Ratings may cause permanent damage to the device. These are stress ratings only and functional operation of the device at these conditions is not implied. Exposure to the absolute maximum ratings conditions for extended periods may affect device reliability.

### 2.1. TABLE 8. ABSOLUTE MAXIMUM RATINGS

PARAMETER	RATING
Supply Voltage ( $V_{DD}$ )	-0.3 V to +1.98 V
Digital Pin Input Voltage	-0.3 V to $V_{DD} + 0.3$ V or 1.98 V, whichever is less
Mechanical Shock	10,000 g
Vibration	Per MIL-STD-883 Method 2007, Test Condition B
Temperature Range	
Operating	-40°C to +85°C
Storage	-55°C to +150°C

Table 8. Absolute Maximum Ratings

### 2.2. ESD CAUTION

	<p>ESD (electrostatic discharge) sensitive device. Charged devices and circuit boards can discharge without detection. Although this product features patented or proprietary protection circuitry, damage may occur on devices subjected to high energy ESD. Therefore proper ESD precautions should be taken to avoid performance degradation or loss of functionality.</p>
---	---

### 2.3. SOLDERING PROFILE

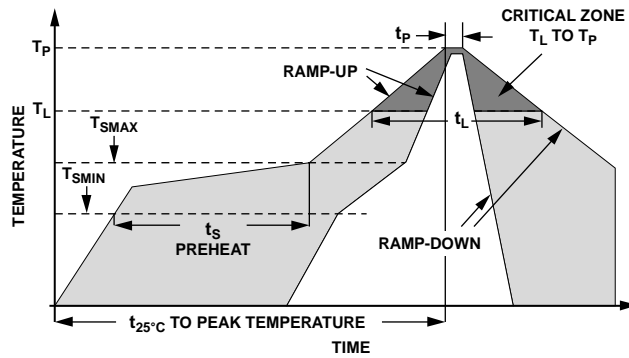

Figure 2. Recommended Soldering Profile Limits

### 2.4. RECOMMENDED SOLDERING PROFILE\*

PROFILE FEATURE		Sn63/Pb37	Pb-Free
Average Ramp Rate ( $T_L$ to $T_P$ )		1.25°C/sec max	1.25°C/sec max
Preheat	Minimum Temperature ( $T_{SMIN}$ )	100°C	100°C
	Maximum Temperature ( $T_{SMAX}$ )	150°C	200°C
	Time ( $T_{SMIN}$ to $T_{SMAX}$ ), $t_s$	60 sec to 75 sec	60 sec to 75 sec
Ramp-Up Rate ( $T_{SMAX}$ to $T_L$ )		1.25°C/sec	1.25°C/sec
Time Maintained Above Liquidous ( $t_L$ )		45 sec to 75 sec	~50 sec
Liquidous Temperature ( $T_L$ )		183°C	217°C
Peak Temperature ( $T_P$ )		215°C +3°C/-3°C	260°C +0°C/-5°C
Time Within +5°C of Actual Peak Temperature ( $t_p$ )		20 sec to 30 sec	20 sec to 30 sec
Ramp-Down Rate		3°C/sec max	3°C/sec max
Time +25°C ( $t_{25°C}$ ) to Peak Temperature		5 min max	5 min max

\*The reflow profile in Table 9 is recommended for board manufacturing with TDK MEMS microphones. All microphones are also compatible with the J-STD-020 profile

Table 9. Recommended Soldering Profile

### 3. PIN CONFIGURATIONS AND FUNCTION DESCRIPTIONS

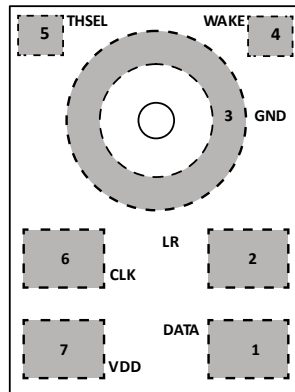

Figure 3. Pin Configuration (Top View, Terminal Side Down)

#### 3.1. PIN FUNCTION DESCRIPTIONS

PIN	NAME	FUNCTION
1	DATA	Digital Output Signal (DATA1 or DATA2)
2	SELECT	Left Channel or Right Channel Select: DATA 1 (right): SELECT tied to GND DATA 2 (left): SELECT tied to VDD. In this setting, SELECT should be tied to the same voltage source as the VDD pin.
3	GND	Ground
4	WAKE	Wake Output Pin. Interrupt pin for Acoustic Activity Detect (AAD) Modes. Outputs HIGH state to indicate the acoustic stimulus exceeds AAD conditions, returns LOW when the stimulus no longer exceeds them. For operation without AAD modes, this pin can be tied to Gnd or left as No Connect.
5	THSEL	Threshold Select Input Pin. Used to both enable and configure AAD Modes. For operation without AAD modes, this pin can be tied to Gnd or left as No Connect.
6	CLK	Clock Input to Microphone
7	VDD	Power Supply. For best performance and to avoid potential parasitic artifacts, place a 0.1 $\mu$ F (100 nF) ceramic type X7R capacitor between Pin 7 (VDD) and ground. Place the capacitor as close to Pin 7 as possible.

Table 10. Pin Function Descriptions

**4. TYPICAL PERFORMANCE CHARACTERISTICS**

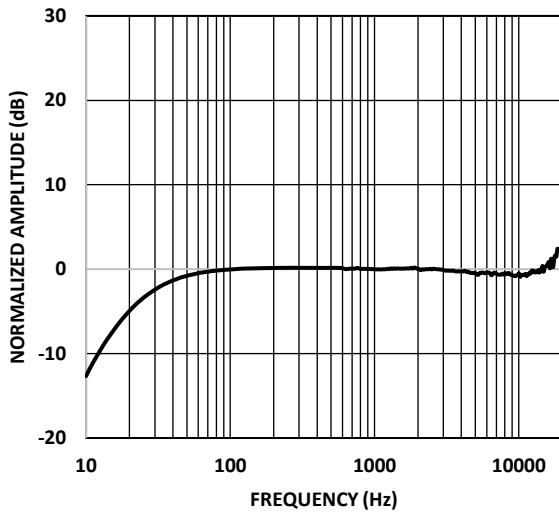

Figure 4. Typical Audio Frequency Response, High Quality Mode

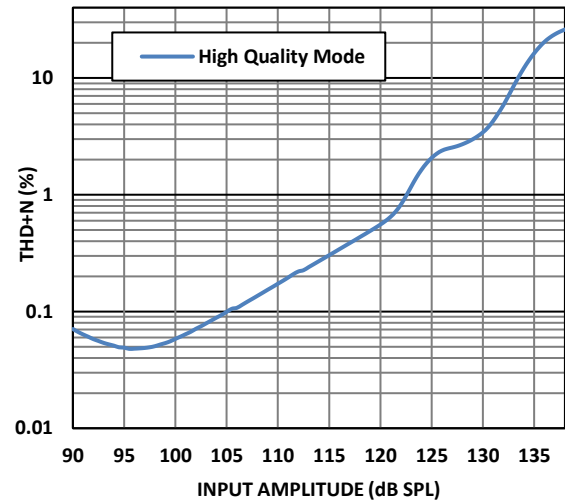

Figure 5. THD + N High Quality Mode

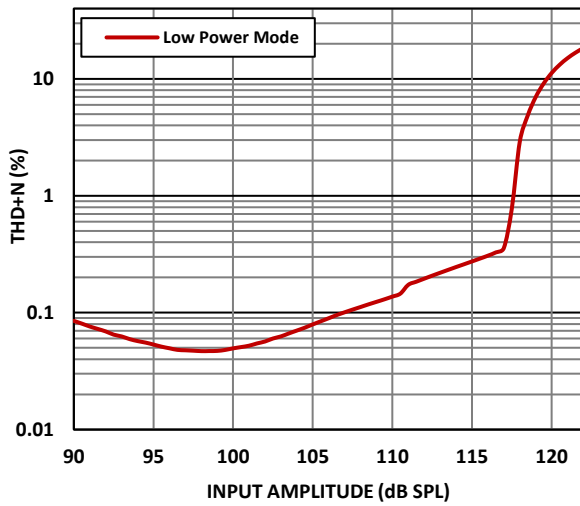

Figure 6. THD + N Low-Power Mode

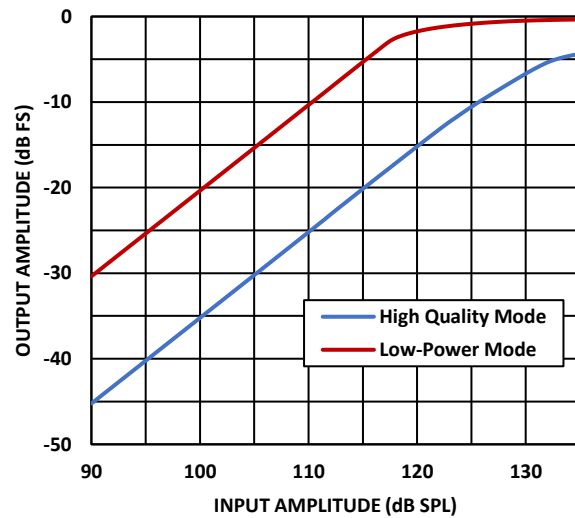

Figure 7. Linearity

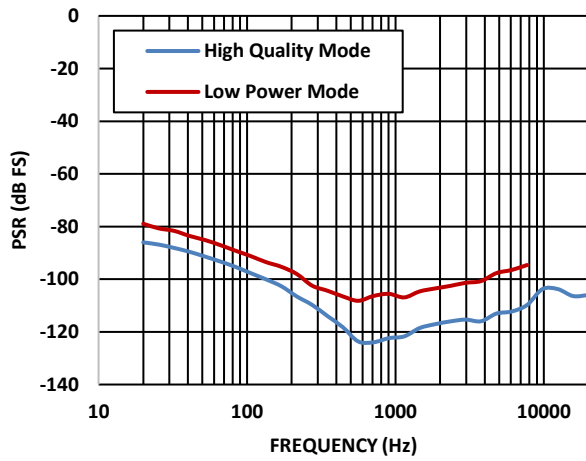

Figure 8. PSR vs Frequency

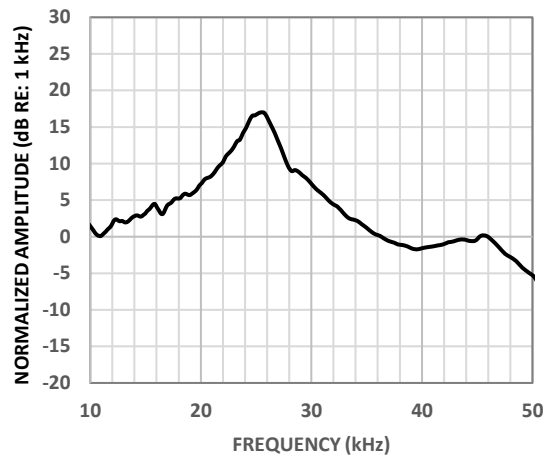

Figure 9. Typical Ultrasonic Frequency Response, Ultrasonic Mode

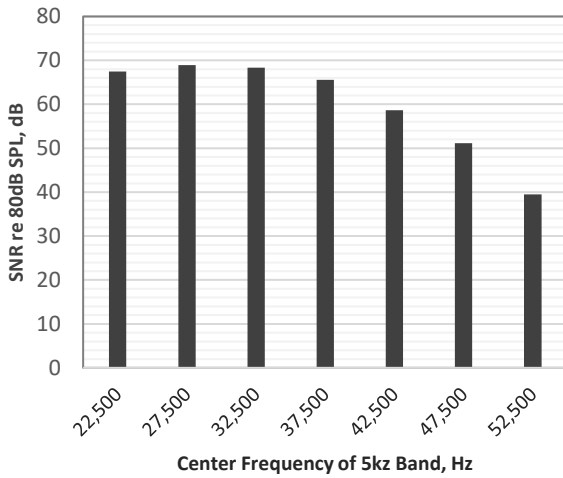

Figure 10. Typical Ultrasonic SNR, Ultrasonic Mode

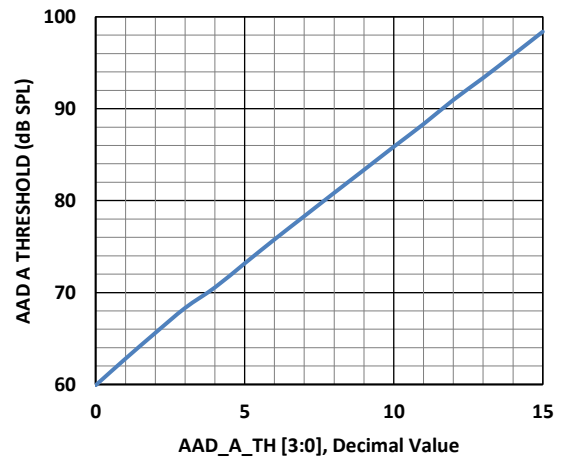

Figure 11 AAD Analog Threshold vs Register Value

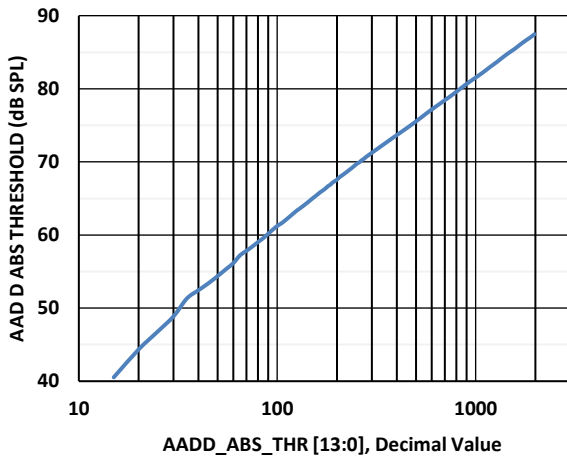

Figure 12. AAD Digital 1,2 Absolute Threshold vs Register Value

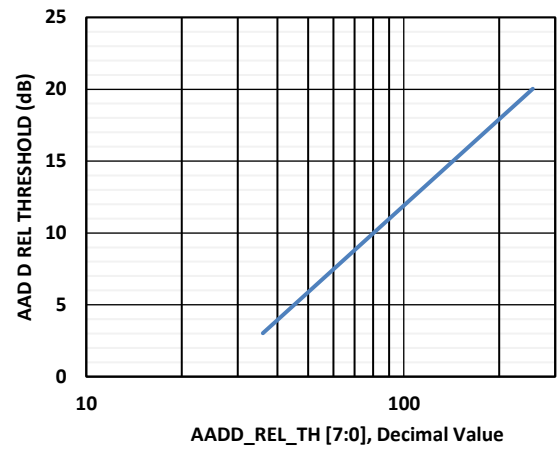

Figure 13. AAD Digital 1,2 Relative Threshold vs Register Value

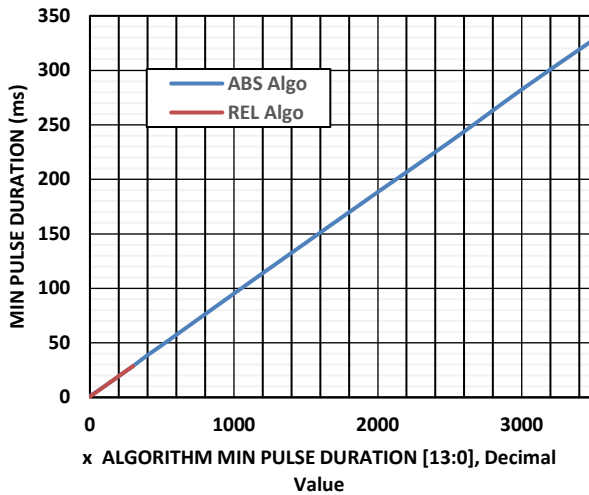

Figure 14. AAD Digital Min Pulse Duration vs Register Value

## 5. MODES OF OPERATION

### 5.1. EXISTING MICROPHONE MODES

Commonly used digital MEMS microphone operating modes are offered on T5838: Sleep, Low Power, High Quality Mode and Ultrasonic Mode. They are selected via the CLK frequency.

### 5.2. ACOUSTIC ACTIVITY DETECT MICROPHONE MODES

T5838 introduces Acoustic Activity Detect (AAD) Modes which are parallel processing features which operate within Sleep and Low Power Modes. The on chip processing of these AAD Modes determine if acoustic activity has occurred or not. There are three different types: AAD Analog, AAD Digital 1 and AAD Digital 2 as outlined in the table below. The activation and configuration for all AAD Modes is carried out via a one wire write on the THSEL pin. When the activity detect conditions are met, the WAKE pin is set HIGH, when the conditions are no longer met the WAKE pin automatically returns LOW (without any type of reset required from the SoC/master).

**5.3. AAD MODES AND DESCRIPTION**

MICROPHONE POWER MODE (IN PARALLEL)	ACOUSTIC ACTIVITY DETECT (AAD) MODE NAME	DESCRIPTION	CONFIGURABLE OPTIONS
Sleep Mode	AAD Analog (AAD A)	Analog activity detect, lowest power	Absolute Threshold (60-97.5dB SPL), LPF (1.1kHz-4.4kHz)
Low-Power Mode	AAD Digital 1 (AAD D1)	Digital activity detect with PDM bitstream	Absolute Threshold (40-87dB SPL), Relative Threshold (3dB-20dB), Pulse Duration
Sleep Mode	AAD Digital 2 (AAD D2)	Digital activity detect without PDM bitstream	Absolute Threshold (40-87dB SPL), Relative Threshold (3dB-20dB), Pulse Duration

**Table 11. AAD Modes and Description**

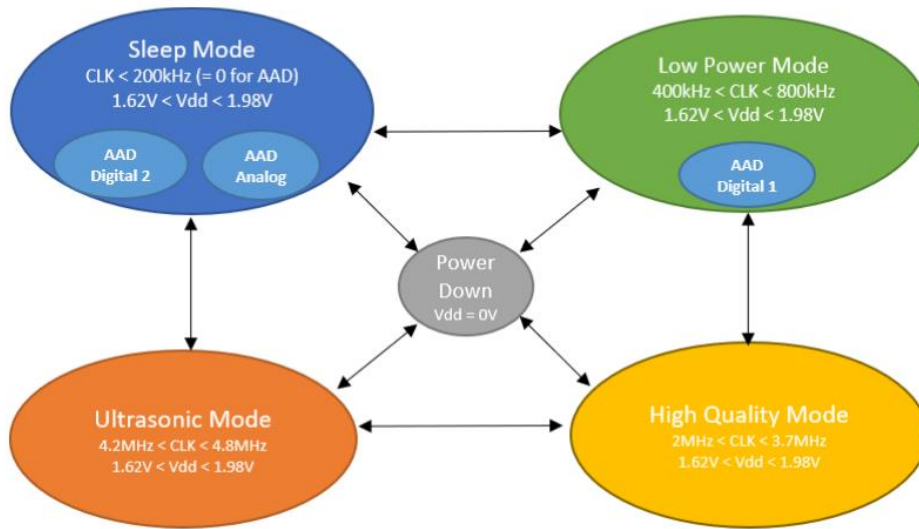

**Figure 15. T5838 Modes of Operation**

**5.4. ACOUSTIC ACTIVITY DETECT ANALOG**

AAD Analog takes the signal from the MEMS after the pre-amp and compares it to the preselected conditions, Absolute Threshold and Low Pass Filter Frequency. If the signal is above the Absolute Threshold and is below the LPF cutoff, the WAKE Pin will be set high. The WAKE pin will continue to remain high while these conditions are met and will return low when the signal level returns below this level. AAD\_A\_EN bit needs to be set and CLK needs to be OFF for AAD Analog (AAD A) to operate. The microphone consumes only 20uA in this mode.

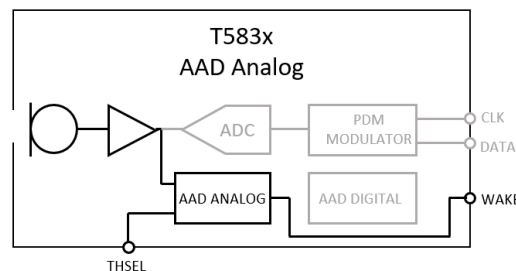

**Figure 16. Block Diagram for AAD Analog Operation**

**5.5. ACOUSTIC ACTIVITY DETECT DIGITAL 1**

AAD Digital 1 is an add on to Low Power Mode where the digital bitstream is analyzed by the AAD Digital logic to see if it meets the preselected conditions Absolute Threshold, Relative Threshold and Pulse Duration. If the conditions are met the WAKE Pin will be set high. The WAKE pin will remain high while these conditions are met and will return low when the signal level returns below this level. The PDM bitstream is running throughout, which allows the Application Processor to buffer the bitstream and carry out 2<sup>nd</sup> stage verification or further analysis of the signal which triggered the AAD Digital 1 (AAD D1) event.

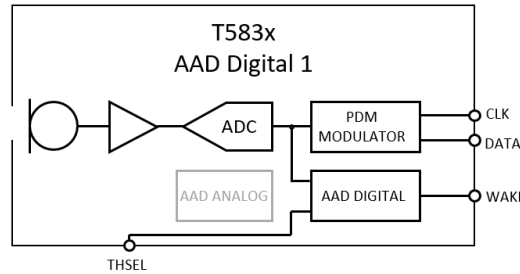

**Figure 17. Block Diagram for AAD Digital 1 Operation**

**5.6. ACOUSTIC ACTIVITY DETECT DIGITAL 2**

AAD Digital 2, like AAD D1 analyzes the digital bitstream to check for activity meeting the preselected conditions (same configurable options as AAD D1). However, AAD D2 does not require an external CLK (by using an internal CLK) allowing power savings at the microphone and at the system level but does not facilitate the PDM bitstream like AAD D1. Like the other AAD modes the WAKE pin is set high when the AAD D2 conditions are met and returns low when the conditions are no longer met.

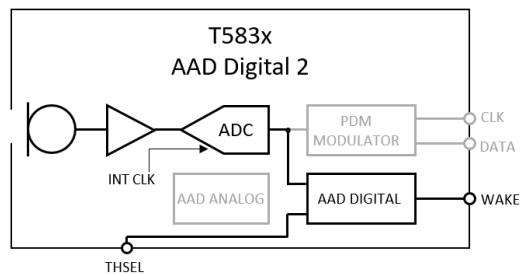

**Figure 18. Block Diagram for AAD Analog Operation**

**5.7. MODE SELECTION AND MODE CHANGES BEFORE AAD ACTIVATION**

AAD A or AAD D1/2 can be configured and enabled while the microphone is in any of its modes (sleep mode one wire writes require CLK active for communication to function i.e. 50kHz<CLK<200kHz). After configuration and enabling, AAD will go active (represented by acoustic activity on the WAKE pin) when the microphone enters its corresponding mode (decided by the CLK frequency). AAD A and AAD D2 are run when the device is in Sleep mode (CLK=OFF), AAD D1 is run when the device is in Low Power mode (CLK=768kHz).

**5.8. AAD STATUS AND DISABLE**

After an AAD mode has been enabled it will remain enabled as long as power is maintained to the microphone or until it has been specifically disabled by setting the AADx\_EN bit to 0.



**5.9. ACOUSTIC ACTIVITY DETECT CONFIGURATION PROTOCOL**

A serial one wire protocol on the THSEL pin controls all the Acoustic Activity Detect modes, AAD A, AAD D1 and AAD D2. The protocol requires the standard PDM CLK to be running at a speed >50kHz and the THSEL pin is modulated proportional to the CLK cycles to create the following symbols for logic zeros or ones which in turn form the device address, register address and data of the command. There are also unique symbols for start/pilot and stop to terminate each write. The start/pilot pulse width is important as it defines the pulse width of the *Zero*, *One*, *Space* and *Stop* symbols. The *Zero* and *One* symbols are a form of encoding to represent bit values of 0 and 1 values respectively. See below for details.

**5.10. ONE WIRE SERIAL PROTOCOL SYMBOLS**

SYMBOL NAME	DESCRIPTION	THSEL CONDITION	SYMBOL PULSE WIDTH		
			MIN	TYPICAL	MAX
Start/Pilot	Start symbol which also defines the PILOT width $T_P$	HIGH	8 CLK cycles	10 CLK cycles	20 CLK cycles
Zero	Symbol for bit value = 0	HIGH		$1 \times T_P$	$1.5 \times T_P$
One	Symbol for bit value = 1	HIGH	$2 \times T_P$	$3 \times T_P$	$3.5 \times T_P$
Stop	Stop symbol	HIGH	$128 \times \text{CLK}$		
Space	Separate individual symbols above	LOW	$1 \times T_P$	$1 \times T_P$	$2 \times T_P$

\*Although operation is guaranteed within the min max ranges it is recommended to use the typical values shown in the table above

**Table 12. One Wire Serial Protocol Symbols**

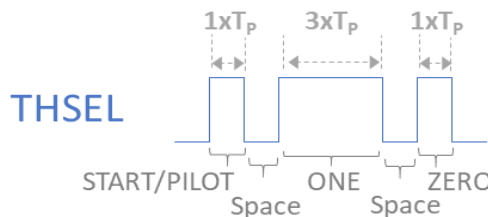

**Figure 19. Example write on THSEL followed by a single bit Zero and One relative to the PILOT**

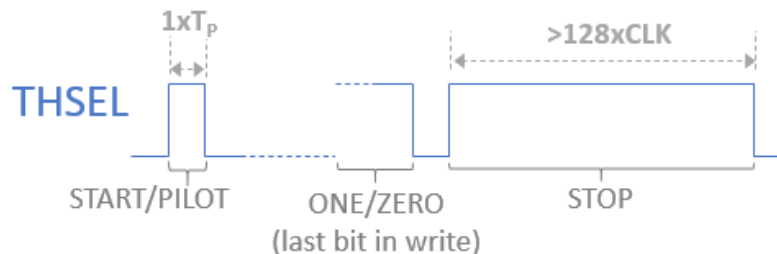

**Figure 20. Write termination with Stop High**

The total write sequence consists of START/PILOT + 24 bits of payload + STOP. The payload consists of three 8 bit fields:

- Device Address + RW =  $7'b1010011$  (Constant for this device) +  $1'b0$  (0 = write, constant for this device)
- Register Address = 8-bit value, determined by AAD function lookup table
- Data = 8-bit value, determined by AAD function lookup table

Example of AAD total write sequence:



Example Write:

- Device Addr+R/W = 10100110 (Constant for this device)
- Register Address = 00000001 (Example Reg Addr only, not an option)
- Register Data = 00000010 (Example data)
- CLK = 100kHz
- T<sub>CLK</sub> = 10us

The write calculations based on 100kHz CLK, 10 CLK cycle PILOT are shown below:

### 5.1. EXAMPLE ONE WIRE WRITE

SYMBOL NAME	DESCRIPTION	THSEL CONDITION	CALCULATION	WIDTH
Start/Pilot	Start/Pilot which indicates start of write and defines logic pulse widths	HIGH	10 X T <sub>CLK</sub>	100us = T <sub>P</sub>
Zero	Single bit Zero	HIGH	1 x T <sub>P</sub>	100us
One	Single bit One	HIGH	3 x T <sub>P</sub>	300us
Stop	Stop Signal (High Method)	HIGH	>128 x CLK period	>1280us
	Stop Signal (Low Method)	LOW	>8 x T <sub>P</sub>	>800us
Space	Separate individual symbols above	LOW	1 x T <sub>P</sub>	100us

Table 13. Example One Wire Write

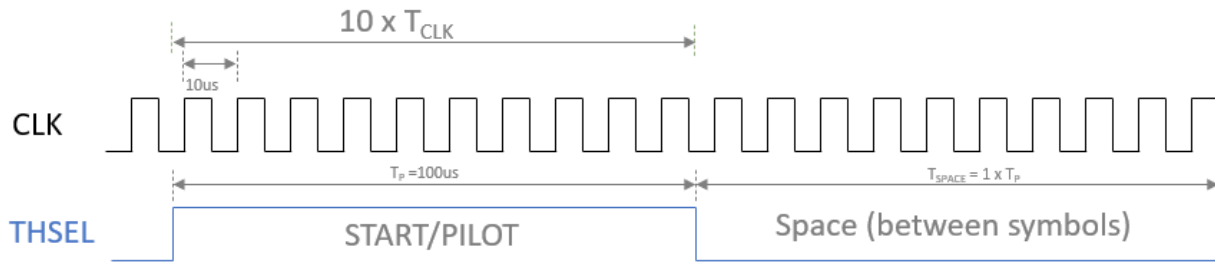

Figure 21. Timing diagram for example above showing relationship between THSEL pilot and CLK

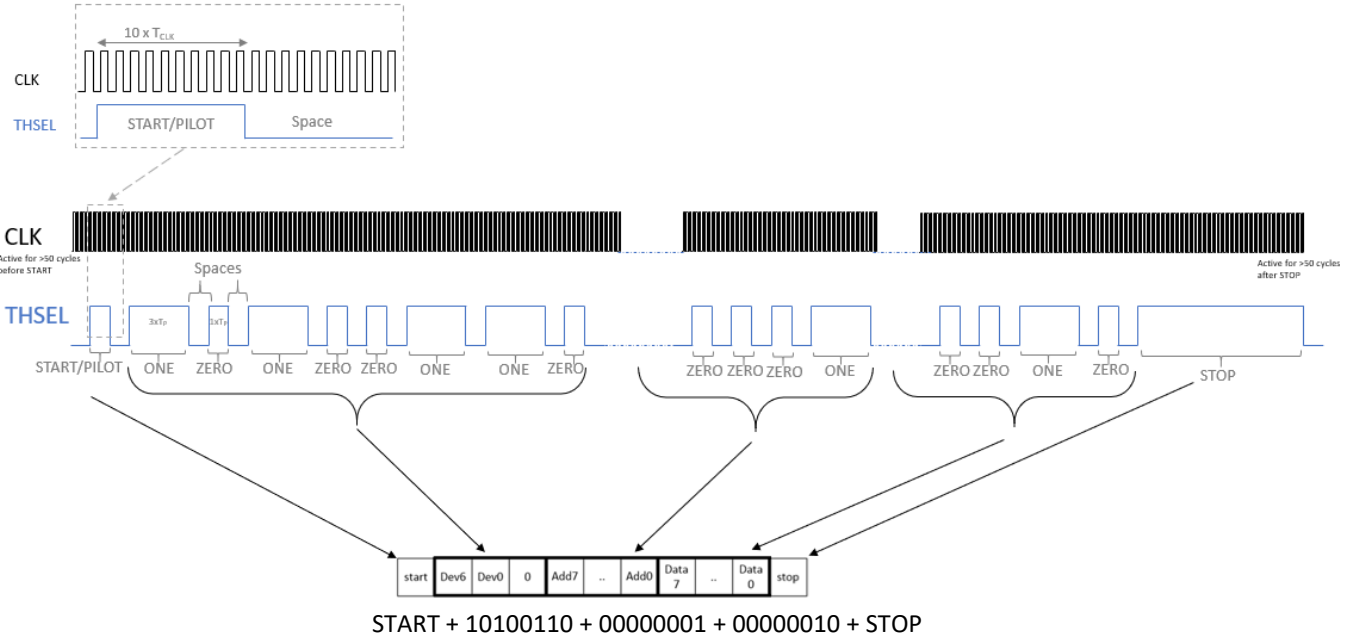

Figure 22. Expanded Timing diagram example showing start, 3 x 8 bit values and stop being written to the device, with the low level translation of each bit to their respective symbols.

### 5.2. AAD ENABLE SEQUENCE

Using the write sequence above, the Acoustic Activity Detect (for all 3 modes) is enabled using the following five writes in this sequence:

### 5.3. AAD ENABLE SEQUENCE WRITES

WRITE #	REGISTER ADDRESS (HEX)	REGISTER DATA (HEX)
1	0x5C	0x00
2	0x3E	0x00
3	0x6F	0x00
4	0x3B	0x00
5	0x4C	0x00

Table 14. AADD Enable Sequence Writes

For example, sequence write #1 from above with Address 0x5C (b01011100) and Data 0x00 (b00000000) would be:

**START + 10100110 + 01011100 + 00000000 + STOP**

After this sequence has been completed any of the configuration settings for the AAD Analog or AAD Digital modes can be adjusted. The enable sequence can be written once to the microphone and will remain valid as long as power is maintained to the microphone. If the mic goes through a power cycle, then the sequence will have to be repeated.

### 5.4. ACOUSTIC ACTIVITY DETECT ANALOG (AAD A) OPERATION AND CONFIGURATION

Acoustic Activity Detect Analog (AAD A) compares the analog signal from the MEMS with the defined conditions configured by the user - threshold level and Low Pass Frequency cutoff. If the acoustic signal meets the conditions set (above the threshold and below the LPF cutoff) then the WAKE pin (pin4) will be set high and will stay high

while the acoustic stimulus continues to meet those conditions. When the acoustic stimulus no longer meets the conditions the WAKE pin will automatically return to a LOW state. See Figure 23. The microphone consumes only 20µA when in AAD A mode.

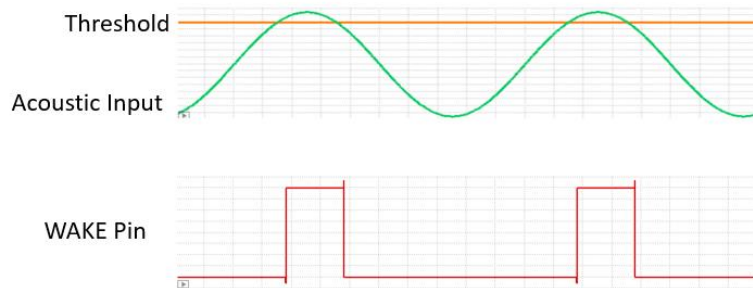

**Figure 23. AAD A Threshold level and WAKE pin activation.**

**5.5. AAD A REGISTERS**

REG NAME	REG ADDR [BIT]	FUNCTION
AAD A_LPF[2:0]	Reg 0x35[2:0]	3-bits to define the Low Pass Filter corner over a range of 1.2kHz to 4.4kHz
AAD A_TH[3:0]	Reg 0x36[3:0]	4-bits to define the Trigger Threshold. Eight levels available from 60dB SPL to 97.5 dB SPL.
AAD A_EN[1]	Reg 0x29[3]	Analog Acoustic Activity Detect (AAD A) Enable. 0 = Disabled, 1 = Enabled. Default = 0

**Table 15. AAD A Registers**

**5.6. AAD A LPF VALUES**

All levels, frequencies, and timing values in the AAD A and AAD D configuration sections are typical.

AAD A_LPF (HEX)	FREQUENCY (kHz)
0x1	4.4
0x2	2.0
0x3	1.9
0x4	1.8
0x5	1.6
0x6	1.3
0x7	1.1

**Table 16. AAD A LPF Values**

### 5.7. AAD A TH VALUES

AAD A_TH [3:0] (HEX)	AAD A_TH (DEC)	THRESHOLD (dB SPL)
0x0	0	60
0x2	2	65
0x4	4	70
0x6	6	75
0x8	8	80
0xA	10	85
0xC	12	90
0xE	14	95
0xF	15	97.5

**Table 17. AAD A TH Values**

### 5.8. AAD A EXAMPLE CONFIGURATION AND ACTIVATION SEQUENCE

AAD Analog can be activated with the following sequence of powerup conditions and register writes:

1. Apply Vdd, apply CLK>50kHz
2. Apply AAD Unlock write sequence:

WRITE #	REGISTER ADDRESS (HEX)	REGISTER DATA (HEX)
1	0x5C	0x00
2	0x3E	0x00
3	0x6F	0x00
4	0x3B	0x00
5	0x4C	0x00

3. Configure AAD A settings, AAD A\_LPF = 0x1 (4.4kHz), AAD A\_TH =0x4 (70dB SPL)

WRITE #	REGISTER ADDRESS (HEX)	REGISTER DATA (HEX)
6	0x35	0x01
7	0x36	0x04

4. Enable AAD A

WRITE #	REGISTER ADDRESS (HEX)	REGISTER DATA (HEX)
8	0x29	0x08

5. Activate AAD A by setting CLK = OFF. The microphone will now set the WAKE pin HIGH in response to acoustic stimulus above 70.5dB SPL and less than 4.4kHz.

### 5.9. AAD A REGISTER MAP

AAD Analog (AAD A) Register Map									
Address	bit 7	bit 6	bit 5	bit 4	bit 3	bit 2	bit 1	bit 0	
29h	Reserved				AAD A_EN	Reserved	AAD D2_EN	AAD D1_EN	
2Ah	Reserved			Unused for AAD A					
2Bh	Unused for AAD A								
2Ch	Reserved								
2Dh	Reserved								
2Eh	Unused for AAD A								
2Fh	Unused for AAD A								
30h	Unused for AAD A								
31h	Unused for AAD A								
32h	Unused for AAD A								
33h	Unused for AAD A								
35h	Reserved					AAD A_LPF[2:0]			
36h	Reserved				AAD A_TH[3:0]				

Table 18. AAD A Register Map

### 5.10. ACOUSTIC ACTIVITY DETECT DIGITAL (AAD D) OPERATION AND CONFIGURATION

AAD Digital provides a more advanced method of activity detection compared to AAD Analog. It has two modes of operation - AAD D1 and AAD D2, where D1 requires an external CLK and provides a PDM bitstream output, and D2 where no external CLK is required, but no PDM bitstream is produced. The activity detection capability operates in the same way for AAD D1 or AAD D2 so the following settings apply to both modes. Their configuration is still applied via one wire writes on the THSEL pin and the output is shown as activity on the WAKE pin.

Both AAD D1 and AAD D2 share registers which are defined as shown in Table 19:

#### 5.11. AAD D REGISTERS

REGISTER NAME	REG ADDR [BIT]	FUNCTION
AADD_EN[1:0]	Reg 0x29[1:0]	Digital Acoustic Activity Detect (AADD). 0x1 = AAD D1 Enable, 0x2 = AAD D2 Enable. Default = 0x0 (AAD D1, D2 both disabled).
AADD_FLOOR[12:0]	Reg0x2A[4:0] Reg0x2B[7:0]	13-bits used to set the Relative Threshold for both AAD D1 and AAD D2 modes. The allowable range for these bits is 0x0F – 0x7BC.
AADD_REL_PULSE_MIN[12:0]	Reg0x2F[3:0] Reg0x2E[7:0]	13-bits used to set the minimum duration the acoustic signal must exceed before the Relative Threshold detection mode is activated. The allowable range for these bits is 0x000 to 0x12C
AADD_ABS_PULSE_MIN[12:0]	Reg0x2F[7:4] Reg0x30[7:0]	13-bits used to set the minimum duration the acoustic signal must exceed before the Absolute Threshold detection mode is activated. The allowable range for these bits is 0x000 to 0xDAA
AADD_ABS_THR[13:0]	Reg0x32[4:0] Reg0x31[7:0]	13-bits used to set the Absolute Threshold detection level. The allowable range for these bits is 0x0F – 0x7BC.
AADD_REL_TH[7:0]	Reg0x33[7:0]	Configures the gain for the AADD modes. See text for details. Gain range is limited to ~45dB to 88dB or 0Fh to FFh

Table 19. AADD Registers

The functionality of the AADD mode registers is shown diagrammatically in Figure 24 below.

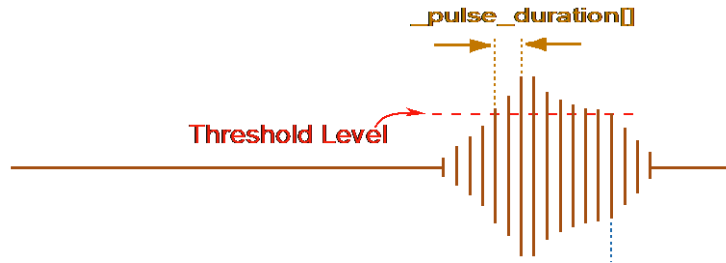

Figure 24. AADD Parameter Visualization

### 5.12. THRESHOLD ALGORITHMS

Once activated, the AAD D processing block waits for an acoustic signal in the voice band to exceed the defined conditions – threshold and minimum pulse duration. There are two threshold options an absolute threshold (similar to AAD Analog, but with wider range and voice band filter), or relative threshold (a dynamic/adaptive threshold also with wide range and voice band filter). The absolute and relative threshold algorithms work in parallel and are described in more detail in the next section. Like AAD Analog, the AAD Digital block sets the WAKE pin high when stimulus exceeds the conditions, WAKE stays high while the stimulus remains at those levels and pulls WAKE low when the stimulus drops below the defined conditions.

### 5.13. ABSOLUTE THRESHOLD ALGORITHM

This is the simplest of the threshold settings and simply sets the threshold above which the AAD is triggered. AADD is a more sophisticated version of the AAD A in that it incorporates parameters like a voice filter and configurable minimum pulse duration to help distinguish voice from background sound.

Setting the **AADD\_ABS\_TH** register defines the sound pressure level which will trigger the wake. It operates similar to AAD A, but with the ability to configure an additional voice filter and minimum pulse duration. It is an absolute value that once the acoustic stimulus exceeds the defined threshold the process of activating the WAKE pin is started. The absolute threshold is set by writing to the 13-bits in register **AADD\_ABS\_TH[12:0]** (reg addresses 0x32 and 0x31). The allowed range of values is 0x00F to 0x7BC.

### 5.14. ABSOLUTE THRESHOLD VALUES

AADD_ABS_TH (HEX)	AAD A_TH (DEC)	THRESHOLD (dB SPL)
F	15	40
16	22	45
32	50	50
37	55	55
5F	95	60
A0	160	65
113	275	70
1E0	480	75
370	880	80
62C	1580	85
7BC	1980	87

Note: Values below 0xF or above 0x7BC are not supported or recommended.

Table 20. Absolute Threshold Values

**5.15. RELATIVE THRESHOLD ALGORITHM**

The Relative Threshold mode operates in a way which allows the threshold to be dynamic i.e. an instantaneous threshold, and is triggered if the threshold exceeds the Established SPL (running average background level) plus a configurable relative level i.e. +6dB or +12dB). The configurable relative level also has an option of setting a floor below which this dynamic threshold will become static and the instantaneous threshold level will be fixed at the floor level plus the relative level. This can be used to avoid false detections at lower SPLs. In summary the behavior of the threshold can be defined for the following scenarios:

- If the incoming SPL is less than the Floor + Relative Threshold -> The Instantaneous Threshold is fixed and is calculated from Floor + Relative Threshold
- If the incoming SPL is Floor + Relative Threshold -> The Instantaneous Threshold is dynamic and is calculated from Established SPL + Relative Threshold

See Figure 25 for a graphical illustration.

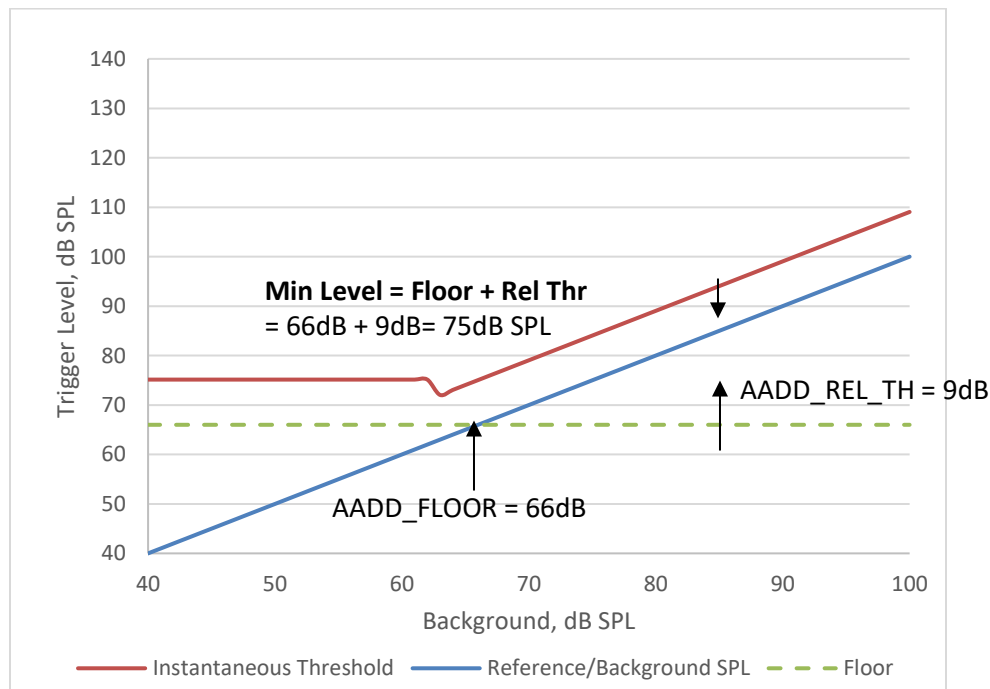

**Figure 25. Relative Threshold with floor indicated**

**5.16. RELATIVE THRESHOLD VALUES**

AADD_REL_TH (HEX)	AADD_REL_TH (DEC)	RELATIVE THRESHOLD (dB)
24	36	+3
36	50	+6
48	72	+9
64	100	+12
8F	143	+15
CA	202	+18
FF	255	+20

**Table 21. Relative Threshold Values**

The floor level register **AADD\_FLOOR[12:0]**, in conjunction with the relative threshold register **AADD\_REL\_TH[7:0]**, defines the required FLOOR level in relation to a background acoustic level after which the threshold tracks the



background dB SPL as it increases and at a level above it defined by the **AADD\_REL\_TH** register. The allowed range for **AADD\_FLOOR[12:0]** is 0x00F to 0x7BC. Values below 0x00F are not allowed. The allowed range for the **AADD\_REL\_TH** register is 0x24 to 0xFF.

For example, with **AADD\_FLOOR[12:0]** = 0xFF (255d) the threshold level will be 69dB SPL.

### 5.17.FLOOR VALUES

AADD_FLOOR [12:0] (HEX)	AADD_FLOOR [12:0] (DEC)	FLOOR LEVEL (dB SPL)
F	15	40
16	22	45
32	50	50
37	55	55
5F	95	60
A0	160	65
113	275	70
1E0	480	75
370	880	80
62C	1580	85
7BC	1980	87

Note: Values below 0xF or above 0x7BC are not supported or recommended.

**Table 20. Absolute Threshold Values**

### 5.18.MINIMUM PULSE DURATION TIME

To prevent the acoustic activity detect circuitry triggering on every acoustic event that exceeds the defined threshold the system requires a minimum duration for the acoustic stimulus to be present before the AADD mode can be defined. This prevents the systems from activating on short duration acoustic impulses that might not be valid triggers. There are two pulse duration times that are configurable - one for Relative Threshold (**AADD\_REL\_PULSE\_MIN[11:0]** at Reg0x2F[3:0] and Reg0x2E[7:0]) and the other for Absolute Threshold mode (**AADD\_ABS\_PULSE\_MIN[12:0]** at Reg0x2F[7:4] and Reg0x30[7:0]).

The pulse minimum time for the relative threshold has a narrower configurable range compared to the option for the absolute threshold, due to the responsiveness of the relative threshold to the environment. It is not recommended to use a pulse minimum value above 0x12C for the AAD\_REL\_PULSE\_MIN as this could result in unresponsive behavior for the relative algorithm.

AADD\_REL\_PULSE\_MIN and AADD\_ABS\_PULSE\_MIN have approximately the same pulse times vs configuration values where their useable ranges overlap. A selection of values for each is shown in table 23 below:

### 5.19. MINIMUM PULSE DURATION TIME VALUES

AADD_x_PULSE_MIN [12:0] (HEX)	AADD_x_PULSE_MIN [12:0] (DEC)	RELATIVE ALGORITHM MIN PULSE DURATION (ms)	ABSOLUTE ALGORITHM MIN PULSE DURATION (ms)
0	0	0.7	1.1
64	100	10	10
C8	200	19	19
12C	300	29	29
1F4	500	N/A	48
3E8	1000	N/A	95
7D0	2000	N/A	188
BB8	3000	N/A	282
DAC	3500	N/A	328

**Table 23. Absolute Threshold Values**

### 5.20. AAD D1 EXAMPLE CONFIGURATION AND ACTIVATION SEQUENCE

AAD Digital 1 can be activated with the following sequence of powerup conditions and register writes:

1. Apply Vdd, apply CLK>50kHz
2. Apply AAD Unlock write sequence:

WRITE #	REGISTER ADDRESS (HEX)	REGISTER DATA (HEX)
1	0x5C	0x00
2	0x3E	0x00
3	0x6F	0x00
4	0x3B	0x00
5	0x4C	0x00

3. Apply AAD D settings, ABS\_TH=0x113 (70dB SPL), FLOOR=0x16 (45dB SPL), RE\_TH =0x24 (+3dB), REL\_PULSE\_MIN=0x0, ABS\_PULSE\_MIN=0;

WRITE #	REGISTER ADDRESS (HEX)	REGISTER DATA (HEX)
6	0x31	0x13 (ABS_TH LSBs)
7	0x32	0x01 (ABS_TH MSBs)
8	0x36	0x04
9	0x2B	0x24
10	0x2E	0x00
11	0x30	0x00

4. Enable AAD D1

WRITE #	REGISTER ADDRESS (HEX)	REGISTER DATA (HEX)
12	0x29	0x01

5. Activate AAD D1 by setting CLK = 768kHz. The microphone will now set the WAKE pin HIGH in response to acoustic stimulus in the voice band above the acoustic threshold.

### 5.21.AAD D2 EXAMPLE CONFIGURATION AND ACTIVATION SEQUENCE

AAD Digital 2 can be activated with the following sequence of powerup conditions and register writes:

1. Apply Vdd, apply CLK>50kHz
2. Apply AAD Unlock write sequence:

WRITE #	REGISTER ADDRESS (HEX)	REGISTER DATA (HEX)
1	0x5C	0x00
2	0x3E	0x00
3	0x6F	0x00
4	0x3B	0x00
5	0x4C	0x00

3. Apply AAD D settings, ABS\_TH=0x113 (70dB SPL), FLOOR=0x16 (45dB SPL), RE\_TH =0x24 (+3dB), REL\_PULSE\_MIN=0x0, ABS\_PULSE\_MIN=0 (same as previous example configuration);

WRITE #	REGISTER ADDRESS (HEX)	REGISTER DATA (HEX)
6	0x31	0x13 (ABS_TH LSBs)
7	0x32	0x01 (ABS_TH MSBs)
8	0x36	0x04
9	0x2B	0x24
10	0x2E	0x00
11	0x30	0x00

4. Enable AAD D2

WRITE #	REGISTER ADDRESS (HEX)	REGISTER DATA (HEX)
12	0x29	0x01

5. Activate AAD D2 by setting CLK = 768kHz. The microphone will now set the WAKE pin HIGH in response to acoustic stimulus in the voice band above the acoustic threshold.

5.22.AAD D REGISTER MAP

AAD Digital (AADD) Register Map								
Address	bit 7	bit 6	bit 5	bit 4	bit 3	bit 2	bit 1	bit 0
29h	Reserved				AAD A_EN	Reserved	AAD D2_EN	AAD D1_EN
2Ah	Reserved			AADD_FLOOR[12:8]				
2Bh	AADD_FLOOR[7:0]							
2Ch	Reserved							
2Dh	Reserved							
2Eh	AADD_REL_PULSE_MIN[7:0]							
2Fh	AADD_ABS_PULSE_MIN[11:8]				AADD_REL_PULSE_MIN[11:8]			
30h	AADD_ABS_PULSE_MIN[7:0]							
31h	AADD_ABS_THR[7:0]							
32h	Reserved			AADD_ABS_THR[12:8]				
33h	AADD_REL_TH[7:0]							
35h	Reserved					Unused for AADD		
36h	Reserved				Unused for AADD			

Table 24. AADD Register Map

6. THEORY OF OPERATION

6.1. PDM DATA FORMAT

The output from the DATA pin of the T5838 is in pulse density modulated (PDM) format. This data is the 1-bit output of a  $\Sigma$ - $\Delta$  modulator. The data is encoded so that the left channel is clocked on the falling edge of CLK, and the right channel is clocked on the rising edge of CLK. After driving the DATA signal high or low in the appropriate half frame of the CLK signal, the DATA driver of the microphone tristates. In this way, two microphones, one set to the left channel and the other to the right, can drive a single DATA line. See Figure 1 for a timing diagram of the PDM data format; the DATA1 and DATA2 lines shown in this figure are two halves of the single physical DATA signal. Figure 26 shows a diagram of the two stereo channels sharing a common DATA line.

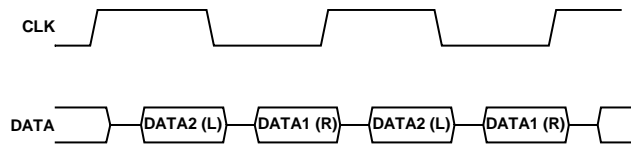

Figure 26. Stereo PDM Format

If only one microphone is connected to the DATA signal, the output is only clocked on a single edge (Figure 27). For example, a left channel microphone is never clocked on the rising edge of CLK. In a single microphone application, each bit of the DATA signal is typically held for the full CLK period until the next transition because the leakage of the DATA line is not enough to discharge the line while the driver is tristated.

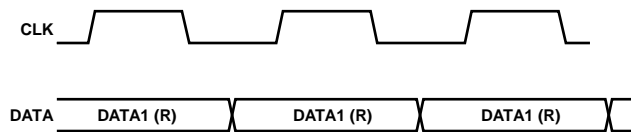

Figure 27. Mono PDM Format

See Table 25 for the channel assignments according to the logic level on the SELECT pin. The setting on the SELECT pin is sampled at power-up and should not be changed during operation.

### 6.2. CHANNEL SETTING

SELECT Pin Setting	Channel
Low (tie to GND)	Right (DATA1)
High (tie to VDD)	Left (DATA2)

**Table 25. T5838 Channel Setting**

For PDM data, the density of the pulses indicates the signal amplitude. A high density of high pulses indicates a signal near positive full scale, and a high density of low pulses indicates a signal near negative full scale. A perfect zero (dc) audio signal shows an alternating pattern of high and low pulses.

The output PDM data signal has a small dc offset of about 3% of full scale. A high-pass filter in the codec that is connected to the digital microphone and does not affect the performance of the microphone typically removes this dc signal.

### 6.3. PDM MICROPHONE SENSITIVITY

The sensitivity of a PDM output microphone is specified with the unit dB FS (decibels relative to digital full scale). A 0 dB FS sine wave is defined as a signal whose peak just touches the full-scale code of the digital word (see Figure 28). This measurement convention also means that signals with a different crest factor may have an RMS level higher than 0 dB FS. For example, a full-scale square wave has an RMS level of 3 dB FS.

This definition of a 0 dB FS signal must be understood when measuring the sensitivity of the T5838. A 1 kHz sine wave at a 94 dB SPL acoustic input to the T5838 results in an output signal with a -26 dB FS level (low-power mode). The output digital word peaks at -26 dB below the digital full-scale level. A common misunderstanding is that the output has an RMS level of -29 dB FS; however, this is not true because of the definition of the 0 dB FS sine wave.

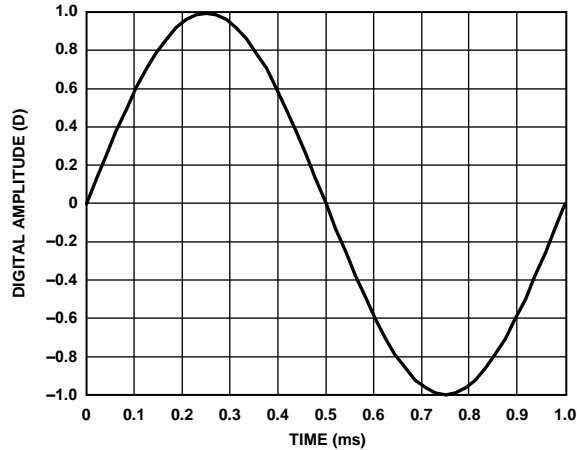

**Figure 28. 1 kHz, 0 dB FS Sine Wave**

There is not a commonly accepted unit of measurement to express the instantaneous level, as opposed to the RMS level of the signal, of a digital signal output from the microphone. Some measurement systems express the instantaneous level of an individual sample in units of D, where 1.0 D is digital full scale. In this case, a -26 dB FS sine wave has peaks at 0.05 D.

## 7. APPLICATIONS INFORMATION

### 7.1. LOW-POWER MODE

Low-Power Mode (LPM) enables the T5838 to be used in an AlwaysOn listening mode for keyword spotting and ambient sound analysis. The T5838 will enter LPM when the frequency of SCK is 768 kHz. In this mode, the microphone consumes only 120  $\mu$ A while retaining high electro-acoustic performance.

When one microphone is in LPM for AlwaysOn listening, a second microphone sharing the same data line may be powered down. In this case, where one microphone is powered up and another is powered down by disabling the VDD supply or in sleep mode by reducing the frequency of a separate clock source, the disabled microphone does not present a load to the signal on the LPM microphone's DATA pin.

### 7.2. DYNAMIC RANGE CONSIDERATIONS

The microphone clips (THD = 10%) at 119dB SPL in Low-Power Mode and at 133 dB SPL in High Quality Mode (see Figure 5); however, it continues to output an increasingly distorted signal above that point. The peak output level, which is controlled by the modulator, limits at 0 dB FS.

To fully use the 107 dB dynamic range of the output data of the T5838 in a design, the digital signal processor (DSP) or codec circuit following it must be chosen carefully. The decimation filter that inputs the PDM signal from the T5838 must have a dynamic range sufficiently better than the dynamic range of the microphone so that the overall noise performance of the system is not degraded. If the decimation filter has a dynamic range of 10 dB better than the microphone, the overall system noise only degrades by 0.4 dB. This 117 dB filter dynamic range requires the filter to have at least 20 bit resolution.

### 7.3. CONNECTING PDM MICROPHONES

A PDM output microphone is typically connected to a codec with a dedicated PDM input. This codec separately decodes the left and right channels and filters the high sample rate modulated data back to the audio frequency band. This codec also generates the clock for the PDM microphones or is synchronous with the source that is generating the clock. Figure 29 and Figure 30 show mono and stereo connections of the T5838 to a codec. The mono connection shows an T5838 set to output data on the right channel. To output on the left channel, tie the SELECT pin to VDD instead of tying it to GND.

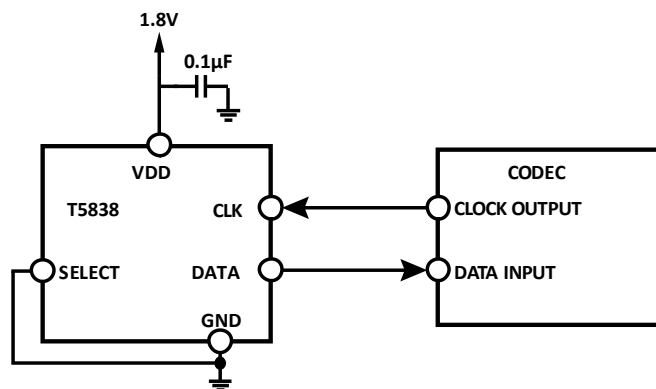

Figure 29. Mono PDM Microphone (Right Channel) Connection to Codec

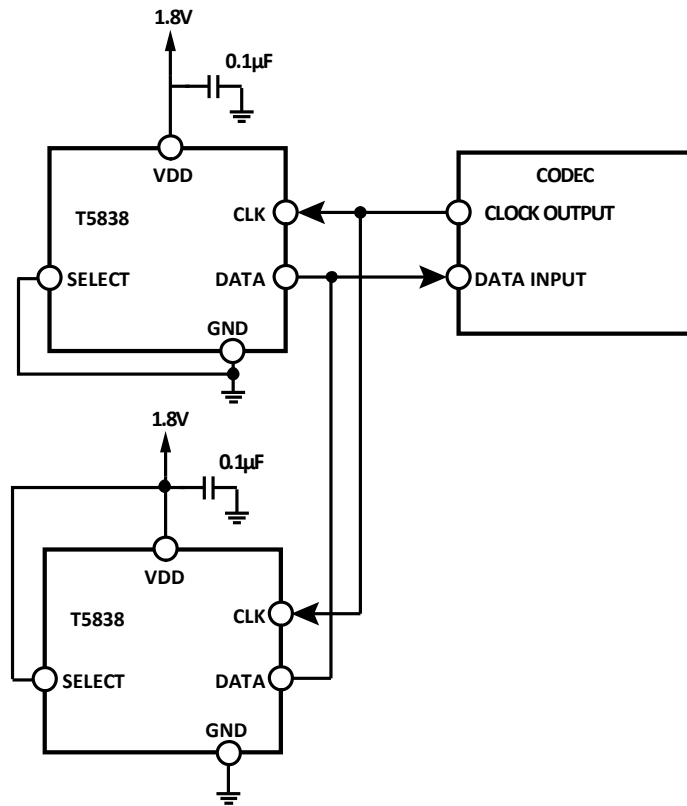

Figure 30. Stereo PDM Microphone Connection to Codec

Decouple the VDD pin of the T5838 to GND with a 0.1  $\mu$ F capacitor. Place this capacitor as close to VDD as the printed circuit board (PCB) layout allows.

Do not use a pull-up or pull-down resistor on the PDM data signal line because it can pull the signal to an incorrect state during the period that the signal line is tristated.

The DATA signal does not need to be buffered in normal use when the T5838 microphone(s) is placed close to the codec on the PCB. If the DATA signal must be driven over a long cable (>15 cm) or other large capacitive load, a digital buffer may be required. Only use a signal buffer on the DATA line when one microphone is in use or after the point where two microphones are connected (see Figure 31). The DATA output of each microphone in a stereo configuration cannot be individually buffered because the two buffer outputs cannot drive a single signal line. If a buffer is used, take care to select one with low propagation delay so that the timing of the data connected to the codec is not corrupted.



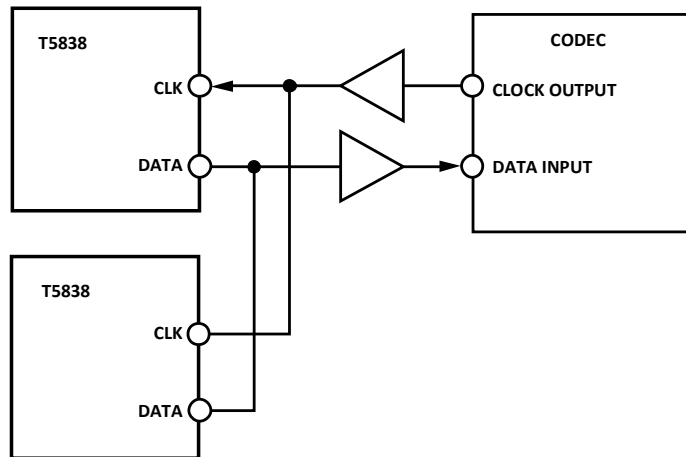

**Figure 31. Buffered Connections Between Stereo T5838s and a Codec**

When long wires are used to connect the codec to the T5838, a source termination resistor can be used on the clock output of the codec instead of a buffer to minimize signal overshoot or ringing. Match the value of this resistor to the characteristic impedance of the CLK trace on the PCB. Depending on the drive capability of the codec clock output, a buffer may still be needed.

#### 7.4. SLEEP MODE

The microphone enters sleep mode when the clock frequency falls below 200 kHz. In this mode, the microphone data output is in a high impedance state. The current consumption in sleep mode is 9  $\mu$ A with a SCK active, 1 $\mu$ A with SCK OFF.

The microphone wakes up from sleep mode and begins to output data 6 ms after the clock becomes active. The wake-up time indicates the time from when the clock is enabled to when the T5838 outputs data within 0.5 dB of its settled sensitivity.

#### 7.5. START-UP TIME

The start-up time of the T5838 is typically 6 ms, measured by the time from when power and clock are enabled until sensitivity of the output signal is within 0.5 dB of its settled sensitivity.

## **8. SUPPORTING DOCUMENTS**

For additional information, see the following documents.

### **8.1. APPLICATION NOTES – GENERAL**

AN-000048, *PDM Digital Output MEMS Microphone Flex Evaluation Board User Guide*

AN-100, *MEMS Microphone Handling and Assembly Guide*

AN-1003, *Recommendations for Mounting and Connecting the TDK, Bottom-Ported MEMS Microphones*

AN-1112, *Microphone Specifications Explained*

AN-1124, *Recommendations for Sealing TDK Bottom-Port MEMS Microphones from Dust and Liquid Ingress*

AN-1140, *Microphone Array Beamforming*

AN-000298, *T583x MEMS Microphone Acoustic Activity Detect User Guide*

### 9. PCB DESIGN AND LAND PATTERN LAYOUT

The recommended PCB land pattern for the T5838 is a 1:1 ratio of the solder pads on the microphone package, as shown in Figure 32. Avoid applying solder paste to the sound hole in the PCB. A suggested solder paste stencil pattern layout is shown in Figure 33.

The response of the T5838 is not affected by the PCB hole size as long as the hole is not smaller than the sound port of the microphone (0.375 mm in diameter). A 0.5 mm to 1 mm diameter for the hole is recommended. Take care to align the hole in the microphone package with the hole in the PCB. The exact degree of the alignment does not affect the microphone performance as long as the holes are not partially or completely blocked.

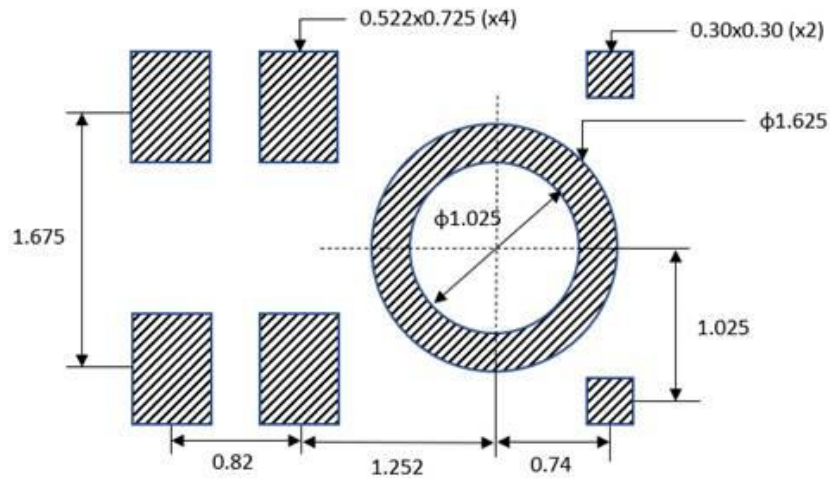

**Figure 32. Recommended PCB Land Pattern Layout**

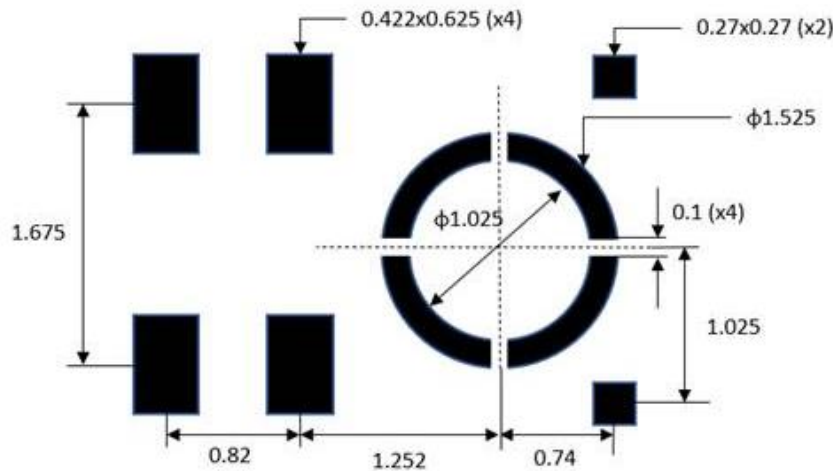

**Figure 33. Suggested Solder Paste Stencil Pattern Layout**

### **9.1. PCB MATERIAL AND THICKNESS**

The performance of the T5838 is not affected by PCB thickness. The T5838 can be mounted on either a rigid or flexible PCB. A flexible PCB with the microphone can be attached directly to the device housing with an adhesive layer. This mounting method offers a reliable seal around the sound port while providing the shortest acoustic path for good sound quality.

## **10. HANDLING INSTRUCTIONS**

### **10.1. PICK AND PLACE EQUIPMENT**

The MEMS microphone can be handled using standard pick-and-place and chip shooting equipment. Take care to avoid damage to the MEMS microphone structure as follows:

- Use a standard pickup tool to handle the microphone. Because the microphone hole is on the bottom of the package, the pickup tool can make contact with any part of the lid surface.
- Do not pick up the microphone with a vacuum tool that makes contact with the bottom side of the microphone.  
Do not pull air out of or blow air into the microphone port.
- Do not use excessive force to place the microphone on the PCB.

### **10.2. REFLOW SOLDER**

For best results, the soldering profile must be in accordance with the recommendations of the manufacturer of the solder paste used to attach the MEMS microphone to the PCB. It is recommended that the solder reflow profile not exceed the limit conditions specified in Figure 2 and Table 9.

T5838 devices have MSL (Moisture Sensitivity Level) rating 3, appropriate JEDEC J-STD-020 guidelines should be followed to avoid damaging the part.

### **10.3. BOARD WASH**

When washing the PCB, ensure that water does not make contact with the microphone port. Do not use blow-off procedures or ultrasonic cleaning.

**11. OUTLINE DIMENSIONS**

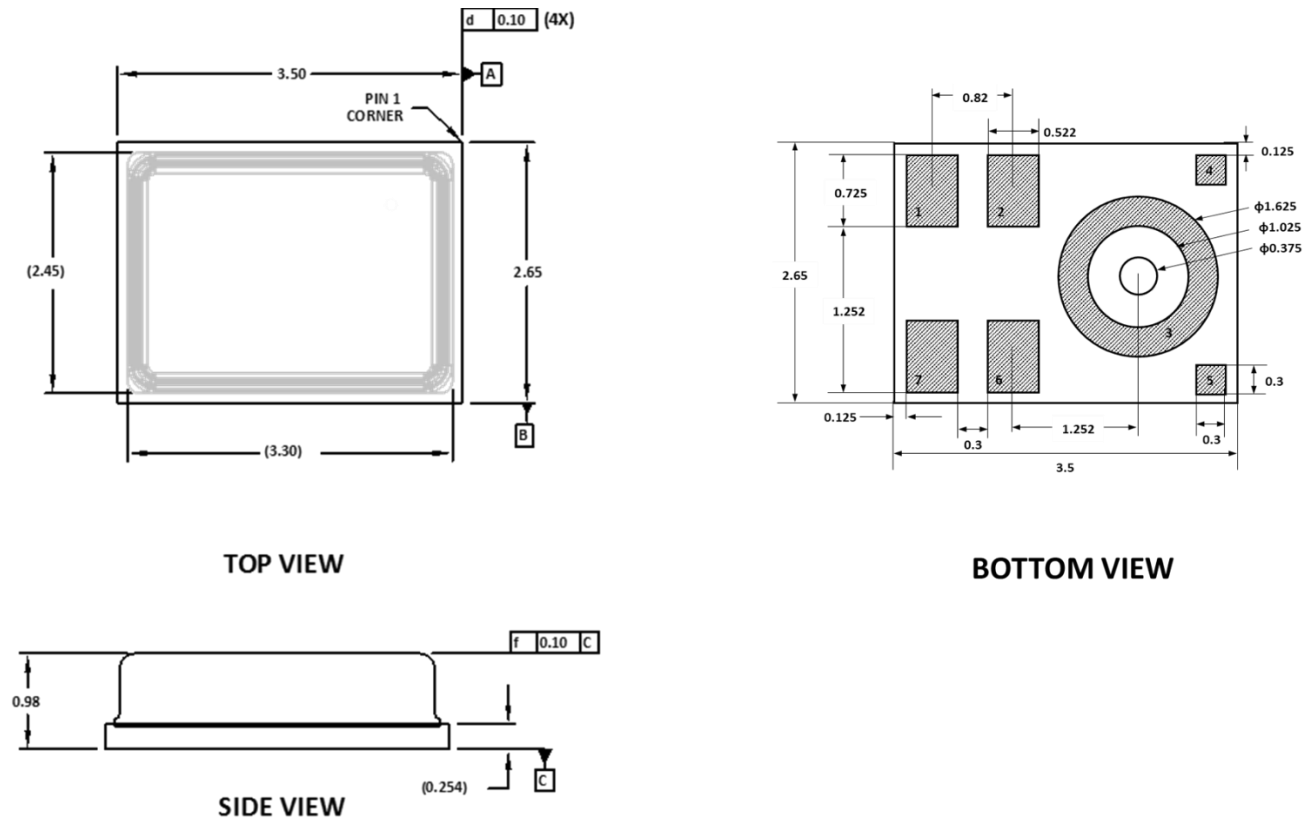

**Figure 34. 5-Terminal Chip Array Small Outline No Lead Cavity [LGA\_CAV]**  
 3.5 mm × 2.65 mm × 0.98 mm Body  
 Dimensions shown in millimeters  
 Dimension tolerance is ±0.15 mm unless otherwise specified

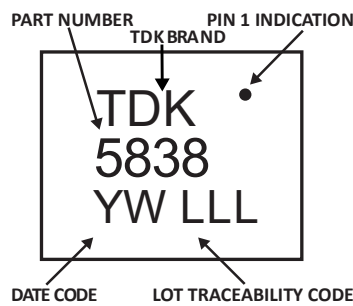

**Figure 35. Package Marking Specification (Top View)**

**11.1. ORDERING GUIDE**

PART	TEMP RANGE	PACKAGE	QUANTITY	PACKAGING
MMICT5838-00-012	-40°C to +85°C	5-Terminal LGA_CAV	10,000	13" Tape and Reel
EV_T5838-FX2	-	Flex Evaluation Board	-	

**11.2. REVISION HISTORY**

REVISION DATE	REVISION	DESCRIPTION
6/11/2022	1.0	Initial version

## **12. COMPLIANCE DECLARATION DISCLAIMER**

TDK believes the environmental and other compliance information given in this document to be correct but cannot guarantee accuracy or completeness. Conformity documents substantiating the specifications and component characteristics are on file. TDK subcontracts manufacturing, and the information contained herein is based on data received from vendors and suppliers, which has not been validated by TDK.

This information furnished by TDK, Inc. ("TDK") is believed to be accurate and reliable. However, no responsibility is assumed by TDK for its use, or for any infringements of patents or other rights of third parties that may result from its use. Specifications are subject to change without notice. TDK reserves the right to make changes to this product, including its circuits and software, in order to improve its design and/or performance, without prior notice. TDK makes no warranties, neither expressed nor implied, regarding the information and specifications contained in this document. TDK assumes no responsibility for any claims or damages arising from information contained in this document, or from the use of products and services detailed therein. This includes, but is not limited to, claims or damages based on the infringement of patents, copyrights, mask work and/or other intellectual property rights.

Certain intellectual property owned by TDK and described in this document is patent protected. No license is granted by implication or otherwise under any patent or patent rights of TDK. This publication supersedes and replaces all information previously supplied. Trademarks that are registered trademarks are the property of their respective companies. TDK sensors should not be used or sold in the development, storage, production or utilization of any conventional or mass-destructive weapons or for any other weapons or life threatening applications, as well as in any other life critical applications such as medical equipment, transportation, aerospace and nuclear instruments, undersea equipment, power plant equipment, disaster prevention and crime prevention equipment.

©2022 TDK. All rights reserved. TDK, MotionTracking, MotionProcessing, MotionProcessor, MotionFusion, MotionApps, DMP, AAR, and the TDK logo are trademarks of TDK, Inc. The TDK logo is a trademark of TDK Corporation. Other company and product names may be trademarks of the respective companies with which they are associated.



©2022 TDK. All rights reserved.

## X-ON Electronics

Largest Supplier of Electrical and Electronic Components

*Click to view similar products for [Audio IC Development Tools](#) category:*

*Click to view products by [TDK](#) manufacturer:*

Other Similar products are found below :

[1580/5171-DEMO](#) [EV\\_ICS-40740-FX](#) [EVALAUDAMP25TOBO1](#) [KITA2GAUDIOSHIELDTOBO1](#) [KITIM69D127V11FLEXTOBO1](#)  
[KITA2GMICARRAYTOBO1](#) [BOB-19389](#) [MIKROE-5721](#) [ESP32-C3-Lyra](#) [BD34352EKV-E2](#) [ESP32-S3-BOX-Lite](#) [SC0368](#) [BOB-21250](#)  
[BD34352EKV-EVK-001](#) [BD34301EKV-EVK-003](#) [QC-ACC-AUDIO-OUT](#) [QC-ACC-AUDIO-IN](#) [EV36K06A](#) [DFR0941](#) [8CH-DMIC](#)  
[MX93AUD-HAT](#) [PAM8965-EVM](#) [U055-B](#) [TPA3223EVM](#) [EV\\_T5838-FX2](#) [MD-54001-D58](#) [EVALAUDIOMA12070PBTBOBO1](#) [KIT-21230](#)  
[EV\\_T5837-FX2](#) [EVALAHNBANALOGV01TOBO1](#) [ABX00061](#) [1063](#) [TAS5756MDCAEVM](#) [TLV320ADC3101EVM-K](#)  
[TLV320AIC3007EVM-K](#) [TLV320AIC3105EVM-K](#) [TLV320AIC3111EVM-K](#) [TLV320AIC3253EVM-K](#) [TLV320DAC32EVM-PDK](#)  
[TPA2035D1EVM](#) [TPA2051D3YFFEVM](#) [TPA3107D2EVM](#) [TPA6120A2EVM](#) [TPA6132A2EVM2](#) [MIKROE-2454](#) [ISD5102EY](#) [1381](#)  
[DA7217-EVAL](#) [DIX4192EVM-PDK](#) [LM48555TLBD](#)