

Inductors for high frequency circuits
Multilayer ceramic
MLG series (for automotive)



AEC-Q200

MLG1005S type



FEATURES

- Advanced monolithic structure is formed using a multilayering and sintering process with ceramic and conductive materials for high-frequency.
- Operating temperature range: -55 to +125°C
- Compliant with AEC-Q200

APPLICATION

- Automotive equipment, smart phones, tablet terminals, high frequency modules (PAs, VCOs, FEMs , etc.), Bluetooth, W-LAN, UWB, tuners and other high frequency circuits for the mobile communication industry
- Application guides: [Car Infotainment](#)

PART NUMBER CONSTRUCTION

MLG	1005	S	0N3	B	T	D25
Series name	L×W×H dimensions 1.0×0.5×0.5 mm	Product internal code	Inductance (nH)	Inductance tolerance	Packaging style	Internal code

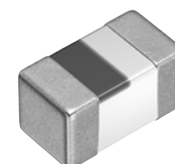

MLG1005S type

CHARACTERISTICS SPECIFICATION TABLE

L (nH)	Q Tolerance	Q min.	L, Q measuring frequency (MHz)	Self-resonant frequency		DC resistance		Rated current (mA)max.	Part No.*
				(GHz)min.	(GHz)typ.	(Ω)max.	(Ω)typ.		
0.3	± 0.1 nH	—	100	10.0	20up	0.10	0.01	1000	MLG1005S0N3BTD25
0.3	± 0.2 nH	—	100	10.0	20up	0.10	0.01	1000	MLG1005S0N3CTD25
0.4	± 0.1 nH	—	100	10.0	20up	0.10	0.01	1000	MLG1005S0N4BTD25
0.4	± 0.2 nH	—	100	10.0	20up	0.10	0.01	1000	MLG1005S0N4CTD25
0.5	± 0.1 nH	—	100	10.0	20up	0.10	0.01	1000	MLG1005S0N5BTD25
0.5	± 0.2 nH	—	100	10.0	20up	0.10	0.01	1000	MLG1005S0N5CTD25
0.6	± 0.1 nH	—	100	10.0	20up	0.10	0.01	1000	MLG1005S0N6BTD25
0.6	± 0.2 nH	—	100	10.0	20up	0.10	0.01	1000	MLG1005S0N6CTD25
0.7	± 0.1 nH	—	100	10.0	18.7	0.10	0.02	1000	MLG1005S0N7BTD25
0.7	± 0.2 nH	—	100	10.0	18.7	0.10	0.02	1000	MLG1005S0N7CTD25
0.8	± 0.1 nH	—	100	10.0	16.4	0.10	0.02	1000	MLG1005S0N8BTD25
0.8	± 0.2 nH	—	100	10.0	16.4	0.10	0.02	1000	MLG1005S0N8CTD25
0.9	± 0.1 nH	—	100	10.0	17.7	0.10	0.04	1000	MLG1005S0N9BTD25
0.9	± 0.2 nH	—	100	10.0	17.7	0.10	0.04	1000	MLG1005S0N9CTD25
1.0	± 0.1 nH	7	100	10.0	13.8	0.10	0.04	1000	MLG1005S1N0BTD25
1.0	± 0.2 nH	7	100	10.0	13.8	0.10	0.04	1000	MLG1005S1N0CTD25
1.0	± 0.3 nH	7	100	10.0	13.8	0.10	0.04	1000	MLG1005S1N0STD25
1.1	± 0.1 nH	7	100	10.0	19.3	0.10	0.03	1000	MLG1005S1N1BTD25
1.1	± 0.2 nH	7	100	10.0	19.3	0.10	0.03	1000	MLG1005S1N1CTD25
1.1	± 0.3 nH	7	100	10.0	19.3	0.10	0.03	1000	MLG1005S1N1STD25
1.2	± 0.1 nH	7	100	10.0	11.6	0.10	0.04	1000	MLG1005S1N2BTD25
1.2	± 0.2 nH	7	100	10.0	11.6	0.10	0.04	1000	MLG1005S1N2CTD25
1.2	± 0.3 nH	7	100	10.0	11.6	0.10	0.04	1000	MLG1005S1N2STD25
1.3	± 0.1 nH	7	100	8.00	11.7	0.10	0.04	1000	MLG1005S1N3BTD25
1.3	± 0.2 nH	7	100	8.00	11.7	0.10	0.04	1000	MLG1005S1N3CTD25
1.3	± 0.3 nH	7	100	8.00	11.7	0.10	0.04	1000	MLG1005S1N3STD25
1.5	± 0.1 nH	7	100	8.00	9.6	0.10	0.06	1000	MLG1005S1N5BTD25
1.5	± 0.2 nH	7	100	8.00	9.6	0.10	0.06	1000	MLG1005S1N5CTD25
1.5	± 0.3 nH	7	100	8.00	9.6	0.10	0.06	1000	MLG1005S1N5STD25
1.6	± 0.1 nH	7	100	7.50	9.4	0.12	0.05	1000	MLG1005S1N6BTD25
1.6	± 0.2 nH	7	100	7.50	9.4	0.12	0.05	1000	MLG1005S1N6CTD25
1.6	± 0.3 nH	7	100	7.50	9.4	0.12	0.05	1000	MLG1005S1N6STD25
1.8	± 0.1 nH	7	100	8.00	10.3	0.15	0.06	900	MLG1005S1N8BTD25
1.8	± 0.2 nH	7	100	8.00	10.3	0.15	0.06	900	MLG1005S1N8CTD25
1.8	± 0.3 nH	7	100	8.00	10.3	0.15	0.06	900	MLG1005S1N8STD25
2.0	± 0.1 nH	7	100	7.50	9.3	0.15	0.07	900	MLG1005S2N0BTD25
2.0	± 0.2 nH	7	100	7.50	9.3	0.15	0.07	900	MLG1005S2N0CTD25
2.0	± 0.3 nH	7	100	7.50	9.3	0.15	0.07	900	MLG1005S2N0STD25
2.2	± 0.1 nH	7	100	7.00	8.6	0.15	0.08	900	MLG1005S2N2BTD25
2.2	± 0.2 nH	7	100	7.00	8.6	0.15	0.08	900	MLG1005S2N2CTD25
2.2	± 0.3 nH	7	100	7.00	8.6	0.15	0.08	900	MLG1005S2N2STD25
2.4	± 0.1 nH	7	100	7.00	8.2	0.15	0.08	800	MLG1005S2N4BTD25
2.4	± 0.2 nH	7	100	7.00	8.2	0.15	0.08	800	MLG1005S2N4CTD25
2.4	± 0.3 nH	7	100	7.00	8.2	0.15	0.08	800	MLG1005S2N4STD25

* Please contact us for information on inductance tolerance, G ($\pm 2\%$).

Measurement equipment

Measurement item	Product No.	Manufacturer
L, Q	4291B +16193A	Keysight Technologies
Self-resonant frequency	8720C	Keysight Technologies
DC resistance	Type-7561	Yokogawa

* Equivalent measurement equipment may be used.

MLG1005S type

CHARACTERISTICS SPECIFICATION TABLE

L (nH)	Q Tolerance	Q min.	L, Q measuring frequency (MHz)	Self-resonant frequency		DC resistance		Rated current (mA)max.	Part No.*
				(GHz)min.	(GHz)typ.	(Ω)max.	(Ω)typ.		
2.7	± 0.1 nH	7	100	6.00	7.3	0.15	0.08	800	MLG1005S2N7BTD25
2.7	± 0.2 nH	7	100	6.00	7.3	0.15	0.08	800	MLG1005S2N7CTD25
2.7	± 0.3 nH	7	100	6.00	7.3	0.15	0.08	800	MLG1005S2N7STD25
3.0	± 0.1 nH	7	100	5.50	6.8	0.20	0.09	800	MLG1005S3N0BTD25
3.0	± 0.2 nH	7	100	5.50	6.8	0.20	0.09	800	MLG1005S3N0CTD25
3.0	± 0.3 nH	7	100	5.50	6.8	0.20	0.09	800	MLG1005S3N0STD25
3.3	± 0.1 nH	8	100	5.00	6.1	0.20	0.09	800	MLG1005S3N3BTD25
3.3	± 0.2 nH	8	100	5.00	6.1	0.20	0.09	800	MLG1005S3N3CTD25
3.3	± 0.3 nH	8	100	5.00	6.1	0.20	0.09	800	MLG1005S3N3STD25
3.6	± 0.1 nH	8	100	5.00	6.7	0.20	0.09	700	MLG1005S3N6BTD25
3.6	± 0.2 nH	8	100	5.00	6.7	0.20	0.09	700	MLG1005S3N6CTD25
3.6	± 0.3 nH	8	100	5.00	6.7	0.20	0.09	700	MLG1005S3N6STD25
3.9	± 0.1 nH	8	100	5.00	6.5	0.20	0.11	700	MLG1005S3N9BTD25
3.9	± 0.2 nH	8	100	5.00	6.5	0.20	0.11	700	MLG1005S3N9CTD25
3.9	± 0.3 nH	8	100	5.00	6.5	0.20	0.11	700	MLG1005S3N9STD25
4.3	± 0.2 nH	8	100	4.50	6.0	0.20	0.11	700	MLG1005S4N3CTD25
4.3	± 0.3 nH	8	100	4.50	6.0	0.20	0.11	700	MLG1005S4N3STD25
4.7	± 0.2 nH	8	100	4.50	5.4	0.25	0.12	700	MLG1005S4N7CTD25
4.7	± 0.3 nH	8	100	4.50	5.4	0.25	0.12	700	MLG1005S4N7STD25
5.1	± 0.2 nH	8	100	4.00	5.0	0.25	0.13	600	MLG1005S5N1CTD25
5.1	± 0.3 nH	8	100	4.00	5.0	0.25	0.13	600	MLG1005S5N1STD25
5.6	± 0.2 nH	8	100	4.00	5.3	0.25	0.14	600	MLG1005S5N6CTD25
5.6	± 0.3 nH	8	100	4.00	5.3	0.25	0.14	600	MLG1005S5N6STD25
6.2	$\pm 3\%$	8	100	4.00	4.7	0.25	0.16	600	MLG1005S6N2HTD25
6.2	± 0.3 nH	8	100	4.00	4.7	0.25	0.16	600	MLG1005S6N2STD25
6.8	$\pm 3\%$	8	100	3.50	4.4	0.25	0.15	600	MLG1005S6N8HTD25
6.8	$\pm 5\%$	8	100	3.50	4.4	0.25	0.15	600	MLG1005S6N8JTD25
7.5	$\pm 3\%$	8	100	3.00	4.1	0.25	0.15	500	MLG1005S7N5HTD25
7.5	$\pm 5\%$	8	100	3.00	4.1	0.25	0.15	500	MLG1005S7N5JTD25
8.2	$\pm 3\%$	8	100	3.00	4.0	0.30	0.19	500	MLG1005S8N2HTD25
8.2	$\pm 5\%$	8	100	3.00	4.0	0.30	0.19	500	MLG1005S8N2JTD25
9.1	$\pm 3\%$	8	100	3.00	3.8	0.30	0.20	500	MLG1005S9N1HTD25
9.1	$\pm 5\%$	8	100	3.00	3.8	0.30	0.20	500	MLG1005S9N1JTD25
10	$\pm 3\%$	8	100	2.50	3.4	0.35	0.22	500	MLG1005S10NHHTD25
10	$\pm 5\%$	8	100	2.50	3.4	0.35	0.22	500	MLG1005S10NJTD25
11	$\pm 3\%$	8	100	2.50	3.5	0.40	0.28	400	MLG1005S11NHHTD25
11	$\pm 5\%$	8	100	2.50	3.5	0.40	0.28	400	MLG1005S11NJTD25
12	$\pm 3\%$	8	100	2.50	3.0	0.40	0.25	400	MLG1005S12NHHTD25
12	$\pm 5\%$	8	100	2.50	3.0	0.40	0.25	400	MLG1005S12NJTD25
13	$\pm 3\%$	8	100	2.40	2.9	0.50	0.26	400	MLG1005S13NHHTD25
13	$\pm 5\%$	8	100	2.40	2.9	0.50	0.26	400	MLG1005S13NJTD25
15	$\pm 3\%$	8	100	2.20	2.8	0.55	0.35	400	MLG1005S15NHHTD25
15	$\pm 5\%$	8	100	2.20	2.8	0.55	0.35	400	MLG1005S15NJTD25

* Please contact us for information on inductance tolerance, G ($\pm 2\%$).

Measurement equipment

Measurement item	Product No.	Manufacturer
L, Q	4291B +16193A	Keysight Technologies
Self-resonant frequency	8720C	Keysight Technologies
DC resistance	Type-7561	Yokogawa

* Equivalent measurement equipment may be used.

MLG1005S type

CHARACTERISTICS SPECIFICATION TABLE

L (nH)	Tolerance	Q min.	L, Q measuring frequency (MHz)	Self-resonant frequency		DC resistance		Rated current (mA)max.	Part No.*
				(GHz)min.	(GHz)typ.	(Ω)max.	(Ω)typ.		
16	$\pm 3\%$	8	100	2.10	2.7	0.55	0.32	400	MLG1005S16NHTD25
16	$\pm 5\%$	8	100	2.10	2.7	0.55	0.32	400	MLG1005S16NJTD25
18	$\pm 3\%$	8	100	2.00	2.5	0.60	0.40	350	MLG1005S18NHTD25
18	$\pm 5\%$	8	100	2.00	2.5	0.60	0.40	350	MLG1005S18NJTD25
20	$\pm 3\%$	8	100	1.90	2.4	0.60	0.38	350	MLG1005S20NHTD25
20	$\pm 5\%$	8	100	1.90	2.4	0.60	0.38	350	MLG1005S20NJTD25
22	$\pm 3\%$	8	100	1.70	2.2	0.70	0.46	350	MLG1005S22NHTD25
22	$\pm 5\%$	8	100	1.70	2.2	0.70	0.46	350	MLG1005S22NJTD25
24	$\pm 3\%$	8	100	1.70	2.1	0.70	0.43	350	MLG1005S24NHTD25
24	$\pm 5\%$	8	100	1.70	2.1	0.70	0.43	350	MLG1005S24NJTD25
27	$\pm 3\%$	8	100	1.60	2.0	0.80	0.53	300	MLG1005S27NHTD25
27	$\pm 5\%$	8	100	1.60	2.0	0.80	0.53	300	MLG1005S27NJTD25
30	$\pm 3\%$	8	100	1.50	1.9	0.80	0.50	300	MLG1005S30NHTD25
30	$\pm 5\%$	8	100	1.50	1.9	0.80	0.50	300	MLG1005S30NJTD25
33	$\pm 3\%$	8	100	1.40	1.8	0.90	0.59	300	MLG1005S33NHTD25
33	$\pm 5\%$	8	100	1.40	1.8	0.90	0.59	300	MLG1005S33NJTD25
36	$\pm 3\%$	8	100	1.30	1.7	1.00	0.62	250	MLG1005S36NHTD25
36	$\pm 5\%$	8	100	1.30	1.7	1.00	0.62	250	MLG1005S36NJTD25
39	$\pm 3\%$	8	100	1.20	1.6	1.00	0.65	250	MLG1005S39NHTD25
39	$\pm 5\%$	8	100	1.20	1.6	1.00	0.65	250	MLG1005S39NJTD25
43	$\pm 3\%$	8	100	1.20	1.6	1.10	0.67	250	MLG1005S43NHTD25
43	$\pm 5\%$	8	100	1.20	1.6	1.10	0.67	250	MLG1005S43NJTD25
47	$\pm 3\%$	8	100	1.10	1.4	1.20	0.75	250	MLG1005S47NHTD25
47	$\pm 5\%$	8	100	1.10	1.4	1.20	0.75	250	MLG1005S47NJTD25
51	$\pm 3\%$	8	100	1.10	1.5	1.20	0.72	250	MLG1005S51NHTD25
51	$\pm 5\%$	8	100	1.10	1.5	1.20	0.72	250	MLG1005S51NJTD25
56	$\pm 3\%$	8	100	1.00	1.3	1.30	0.83	200	MLG1005S56NHTD25
56	$\pm 5\%$	8	100	1.00	1.3	1.30	0.83	200	MLG1005S56NJTD25
62	$\pm 3\%$	8	100	1.00	1.3	1.40	0.85	200	MLG1005S62NHTD25
62	$\pm 5\%$	8	100	1.00	1.3	1.40	0.85	200	MLG1005S62NJTD25
68	$\pm 3\%$	8	100	0.80	1.1	1.50	0.87	200	MLG1005S68NHTD25
68	$\pm 5\%$	8	100	0.80	1.1	1.50	0.87	200	MLG1005S68NJTD25
75	$\pm 3\%$	8	100	0.75	1.1	1.50	0.93	200	MLG1005S75NHTD25
75	$\pm 5\%$	8	100	0.75	1.1	1.50	0.93	200	MLG1005S75NJTD25
82	$\pm 3\%$	8	100	0.70	1.0	1.60	1.01	200	MLG1005S82NHTD25
82	$\pm 5\%$	8	100	0.70	1.0	1.60	1.01	200	MLG1005S82NJTD25
91	$\pm 3\%$	8	100	0.70	0.9	1.80	1.14	200	MLG1005S91NHTD25
91	$\pm 5\%$	8	100	0.70	0.9	1.80	1.14	200	MLG1005S91NJTD25
100	$\pm 3\%$	8	100	0.70	0.9	2.00	1.37	200	MLG1005SR10HTD25
100	$\pm 5\%$	8	100	0.70	0.9	2.00	1.37	200	MLG1005SR10JTD25
110	$\pm 3\%$	8	100	0.70	0.9	2.20	1.48	150	MLG1005SR11HTD25
110	$\pm 5\%$	8	100	0.70	0.9	2.20	1.48	150	MLG1005SR11JTD25
120	$\pm 3\%$	8	100	0.60	0.8	2.20	1.48	150	MLG1005SR12HTD25
120	$\pm 5\%$	8	100	0.60	0.8	2.20	1.48	150	MLG1005SR12JTD25

* Please contact us for information on inductance tolerance, G ($\pm 2\%$).

Measurement equipment

Measurement item	Product No.	Manufacturer
L, Q	4291B +16193A	Keysight Technologies
Self-resonant frequency	8720C	Keysight Technologies
DC resistance	Type-7561	Yokogawa

* Equivalent measurement equipment may be used.

MLG1005S type

■ CHARACTERISTICS SPECIFICATION TABLE

L (nH)	Tolerance	Q min.	L, Q measuring frequency (MHz)	Self-resonant frequency		DC resistance		Rated current (mA)max.	Part No.*
				(GHz)min.	(GHz)typ.	(Ω)max.	(Ω)typ.		
130	$\pm 3\%$	8	100	0.60	0.8	2.50	1.68	150	MLG1005SR13HTD25
130	$\pm 5\%$	8	100	0.60	0.8	2.50	1.68	150	MLG1005SR13JTD25
150	$\pm 3\%$	8	100	0.55	0.7	3.50	2.44	150	MLG1005SR15HTD25
150	$\pm 5\%$	8	100	0.55	0.7	3.50	2.44	150	MLG1005SR15JTD25
160	$\pm 3\%$	8	100	0.50	0.6	3.80	2.74	150	MLG1005SR16HTD25
160	$\pm 5\%$	8	100	0.50	0.6	3.80	2.74	150	MLG1005SR16JTD25
180	$\pm 3\%$	8	100	0.50	0.6	3.80	2.88	150	MLG1005SR18HTD25
180	$\pm 5\%$	8	100	0.50	0.6	3.80	2.88	150	MLG1005SR18JTD25
200	$\pm 3\%$	8	100	0.42	0.5	4.20	3.15	100	MLG1005SR20HTD25
200	$\pm 5\%$	8	100	0.42	0.5	4.20	3.15	100	MLG1005SR20JTD25
220	$\pm 3\%$	8	100	0.45	0.5	4.20	3.02	100	MLG1005SR22HTD25
220	$\pm 5\%$	8	100	0.45	0.5	4.20	3.02	100	MLG1005SR22JTD25
240	$\pm 3\%$	8	100	0.40	0.5	4.80	3.42	100	MLG1005SR24HTD25
240	$\pm 5\%$	8	100	0.40	0.5	4.80	3.42	100	MLG1005SR24JTD25
270	$\pm 3\%$	8	100	0.40	0.5	4.80	3.54	100	MLG1005SR27HTD25
270	$\pm 5\%$	8	100	0.40	0.5	4.80	3.54	100	MLG1005SR27JTD25
300	$\pm 3\%$	6	50	0.35	0.4	6.50	4.82	50	MLG1005SR30HTD25
300	$\pm 5\%$	6	50	0.35	0.4	6.50	4.82	50	MLG1005SR30JTD25
330	$\pm 3\%$	6	50	0.35	0.4	7.00	5.21	50	MLG1005SR33HTD25
330	$\pm 5\%$	6	50	0.35	0.4	7.00	5.21	50	MLG1005SR33JTD25
360	$\pm 3\%$	6	50	0.30	0.4	7.50	5.39	50	MLG1005SR36HTD25
360	$\pm 5\%$	6	50	0.30	0.4	7.50	5.39	50	MLG1005SR36JTD25
390	$\pm 3\%$	6	50	0.30	0.4	8.00	5.97	50	MLG1005SR39HTD25
390	$\pm 5\%$	6	50	0.30	0.4	8.00	5.97	50	MLG1005SR39JTD25

* Please contact us for information on inductance tolerance, G ($\pm 2\%$).

Measurement equipment

Measurement item	Product No.	Manufacturer
L, Q	4291B +16193A	Keysight Technologies
Self-resonant frequency	8720C	Keysight Technologies
DC resistance	Type-7561	Yokogawa

* Equivalent measurement equipment may be used.

MLG1005S type

L, Q FREQUENCY CHARACTERISTICS TABLE

L(nH)typ.					Q typ.					Part No.*
500MHz	800MHz	1.8GHz	2.0GHz	2.4GHz	500MHz	800MHz	1.8GHz	2.0GHz	2.4GHz	
0.3	0.3	0.3	0.3	0.3	22min.	27min.	46min.	49min.	53min.	MLG1005S0N3BTD25
0.3	0.3	0.3	0.3	0.3	22min.	27min.	46min.	49min.	53min.	MLG1005S0N3CTD25
0.4	0.4	0.4	0.4	0.4	22min.	27min.	46min.	49min.	53min.	MLG1005S0N4BTD25
0.4	0.4	0.4	0.4	0.4	22min.	27min.	46min.	49min.	53min.	MLG1005S0N4CTD25
0.5	0.5	0.5	0.5	0.5	22min.	27min.	46min.	49min.	53min.	MLG1005S0N5BTD25
0.5	0.5	0.5	0.5	0.5	22min.	27min.	46min.	49min.	53min.	MLG1005S0N5CTD25
0.6	0.6	0.6	0.6	0.6	22	27	46	49	53	MLG1005S0N6BTD25
0.6	0.6	0.6	0.6	0.6	22	27	46	49	53	MLG1005S0N6CTD25
0.7	0.7	0.7	0.7	0.7	22	28	45	49	54	MLG1005S0N7BTD25
0.7	0.7	0.7	0.7	0.7	22	28	45	49	54	MLG1005S0N7CTD25
0.8	0.8	0.8	0.8	0.8	26	34	57	60	66	MLG1005S0N8BTD25
0.8	0.8	0.8	0.8	0.8	26	34	57	60	66	MLG1005S0N8CTD25
0.9	0.8	0.8	0.8	0.8	21	27	44	47	53	MLG1005S0N9BTD25
0.9	0.8	0.8	0.8	0.8	21	27	44	47	53	MLG1005S0N9CTD25
0.9	0.9	0.9	0.9	0.9	22	29	48	50	56	MLG1005S1N0BTD25
0.9	0.9	0.9	0.9	0.9	22	29	48	50	56	MLG1005S1N0CTD25
1.0	1.0	1.0	1.0	1.0	23	29	47	50	57	MLG1005S1N1BTD25
1.0	1.0	1.0	1.0	1.0	23	29	47	50	57	MLG1005S1N1CTD25
1.0	1.0	1.0	1.0	1.0	23	29	47	50	57	MLG1005S1N1STD25
1.1	1.1	1.1	1.1	1.1	23	29	48	50	56	MLG1005S1N2BTD25
1.1	1.1	1.1	1.1	1.1	23	29	48	50	56	MLG1005S1N2CTD25
1.1	1.1	1.1	1.1	1.1	23	29	48	50	56	MLG1005S1N2STD25
1.2	1.2	1.2	1.2	1.2	22	27	44	47	53	MLG1005S1N3BTD25
1.2	1.2	1.2	1.2	1.2	22	27	44	47	53	MLG1005S1N3CTD25
1.2	1.2	1.2	1.2	1.2	22	27	44	47	53	MLG1005S1N3STD25
1.4	1.4	1.4	1.5	1.5	23	29	47	50	56	MLG1005S1N5BTD25
1.4	1.4	1.4	1.5	1.5	23	29	47	50	56	MLG1005S1N5CTD25
1.4	1.4	1.4	1.5	1.5	23	29	47	50	56	MLG1005S1N5STD25
1.5	1.5	1.5	1.6	1.6	23	29	46	49	54	MLG1005S1N6BTD25
1.5	1.5	1.5	1.6	1.6	23	29	46	49	54	MLG1005S1N6CTD25
1.5	1.5	1.5	1.6	1.6	23	29	46	49	54	MLG1005S1N6STD25
1.7	1.7	1.7	1.7	1.7	20	26	41	43	49	MLG1005S1N8BTD25
1.7	1.7	1.7	1.7	1.7	20	26	41	43	49	MLG1005S1N8CTD25
1.7	1.7	1.7	1.7	1.7	20	26	41	43	49	MLG1005S1N8STD25
1.9	1.9	1.9	1.9	1.9	21	25	41	43	48	MLG1005S2N0BTD25
1.9	1.9	1.9	1.9	1.9	21	25	41	43	48	MLG1005S2N0CTD25
1.9	1.9	1.9	1.9	1.9	21	25	41	43	48	MLG1005S2N0STD25
2.1	2.1	2.1	2.1	2.2	22	27	44	47	52	MLG1005S2N2BTD25
2.1	2.1	2.1	2.1	2.2	22	27	44	47	52	MLG1005S2N2CTD25
2.1	2.1	2.1	2.1	2.2	22	27	44	47	52	MLG1005S2N2STD25

* Please contact us for information on inductance tolerance, G ($\pm 2\%$).

Measurement equipment

Product No.	Manufacturer
4291B +16193A	Keysight Technologies

* Equivalent measurement equipment may be used.

MLG1005S type

L, Q FREQUENCY CHARACTERISTICS TABLE

L(nH)typ.					Q typ.					Part No.*
500MHz	800MHz	1.8GHz	2.0GHz	2.4GHz	500MHz	800MHz	1.8GHz	2.0GHz	2.4GHz	
2.3	2.3	2.3	2.3	2.4	21	26	42	44	49	MLG1005S2N4BTD25
2.3	2.3	2.3	2.3	2.4	21	26	42	44	49	MLG1005S2N4CTD25
2.3	2.3	2.3	2.3	2.4	21	26	42	44	49	MLG1005S2N4STD25
2.6	2.6	2.6	2.7	2.7	22	27	43	45	50	MLG1005S2N7BTD25
2.6	2.6	2.6	2.7	2.7	22	27	43	45	50	MLG1005S2N7CTD25
2.6	2.6	2.6	2.7	2.7	22	27	43	45	50	MLG1005S2N7STD25
2.9	2.9	3.0	3.0	3.1	24	29	47	49	54	MLG1005S3N0BTD25
2.9	2.9	3.0	3.0	3.1	24	29	47	49	54	MLG1005S3N0CTD25
2.9	2.9	3.0	3.0	3.1	24	29	47	49	54	MLG1005S3N0STD25
3.2	3.2	3.3	3.4	3.5	24	30	46	48	53	MLG1005S3N3BTD25
3.2	3.2	3.3	3.4	3.5	24	30	46	48	53	MLG1005S3N3CTD25
3.2	3.2	3.3	3.4	3.5	24	30	46	48	53	MLG1005S3N3STD25
3.4	3.4	3.6	3.6	3.8	21	26	40	42	46	MLG1005S3N6BTD25
3.4	3.4	3.6	3.6	3.8	21	26	40	42	46	MLG1005S3N6CTD25
3.4	3.4	3.6	3.6	3.8	21	26	40	42	46	MLG1005S3N6STD25
3.7	3.7	3.9	3.9	4.1	22	28	43	45	50	MLG1005S3N9BTD25
3.7	3.7	3.9	3.9	4.1	22	28	43	45	50	MLG1005S3N9CTD25
3.7	3.7	3.9	3.9	4.1	22	28	43	45	50	MLG1005S3N9STD25
4.1	4.1	4.3	4.4	4.6	24	30	47	49	53	MLG1005S4N3CTD25
4.1	4.1	4.3	4.4	4.6	24	30	47	49	53	MLG1005S4N3STD25
4.5	4.5	4.8	4.9	5.2	23	30	45	47	50	MLG1005S4N7CTD25
4.5	4.5	4.8	4.9	5.2	23	30	45	47	50	MLG1005S4N7STD25
4.9	4.9	5.4	5.6	6.1	23	29	42	43	44	MLG1005S5N1CTD25
4.9	4.9	5.4	5.6	6.1	23	29	42	43	44	MLG1005S5N1STD25
5.4	5.4	5.8	5.9	6.3	22	28	42	43	45	MLG1005S5N6CTD25
5.4	5.4	5.8	5.9	6.3	22	28	42	43	45	MLG1005S5N6STD25
6.0	6.0	6.8	7.1	7.8	24	29	42	43	43	MLG1005S6N2HTD25
6.0	6.0	6.8	7.1	7.8	24	29	42	43	43	MLG1005S6N2STD25
6.5	6.6	7.4	7.8	8.6	23	28	40	41	41	MLG1005S6N8HTD25
6.5	6.6	7.4	7.8	8.6	23	28	40	41	41	MLG1005S6N8JTD25
7.2	7.4	8.6	9.2	10.5	24	30	41	41	39	MLG1005S7N5HTD25
7.2	7.4	8.6	9.2	10.5	24	30	41	41	39	MLG1005S7N5JTD25
7.9	8.0	9.3	9.9	11.3	23	28	38	38	36	MLG1005S8N2HTD25
7.9	8.0	9.3	9.9	11.3	23	28	38	38	36	MLG1005S8N2JTD25
8.8	9.0	10.8	11.6	13.7	24	30	40	39	36	MLG1005S9N1HTD25
8.8	9.0	10.8	11.6	13.7	24	30	40	39	36	MLG1005S9N1JTD25
9.7	9.9	12.4	13.5	16.7	24	30	37	36	31	MLG1005S10NHTD25
9.7	9.9	12.4	13.5	16.7	24	30	37	36	31	MLG1005S10NJTD25
10.6	10.9	13.8	15.1	19	23	28	34	33	28	MLG1005S11NHTD25
10.6	10.9	13.8	15.1	19	23	28	34	33	28	MLG1005S11NJTD25
11.7	12.1	16.2	18.3		23	29	33	31		MLG1005S12NHTD25
11.7	12.1	16.2	18.3		23	29	33	31		MLG1005S12NJTD25

* Please contact us for information on inductance tolerance, G ($\pm 2\%$).

Measurement equipment

Product No.	Manufacturer
4291B +16193A	Keysight Technologies

* Equivalent measurement equipment may be used.

MLG1005S type

L, Q FREQUENCY CHARACTERISTICS TABLE

L(nH)typ.					Q typ.					Part No.*
500MHz	800MHz	1.8GHz	2.0GHz	2.4GHz	500MHz	800MHz	1.8GHz	2.0GHz	2.4GHz	
12.6	13.0	18.3	21.3		20	24	25	22		MLG1005S13NHDT25
12.6	13.0	18.3	21.3		20	24	25	22		MLG1005S13NJTD25
14.7	15.3	22.0	26.0		23	28	29	26		MLG1005S15NHDT25
14.7	15.3	22.0	26.0		23	28	29	26		MLG1005S15NJTD25
15.6	16.2	24.1	29.0		22	26	26	22		MLG1005S16NHDT25
15.6	16.2	24.1	29.0		22	26	26	22		MLG1005S16NJTD25
17.7	18.6	29.0			23	28	26			MLG1005S18NHDT25
17.7	18.6	29.0			23	28	26			MLG1005S18NJTD25
19.7	20.8	36.8			21	25	21			MLG1005S20NHDT25
19.7	20.8	36.8			21	25	21			MLG1005S20NJTD25
21.8	23.3				22	27				MLG1005S22NHDT25
21.8	23.3				22	27				MLG1005S22NJTD25
23.8	25.5				22	26				MLG1005S24NHDT25
23.8	25.5				22	26				MLG1005S24NJTD25
27.0	29.6				20	23				MLG1005S27NHDT25
27.0	29.6				20	23				MLG1005S27NJTD25
30.1	33.5				19	21				MLG1005S30NHDT25
30.1	33.5				19	21				MLG1005S30NJTD25
33.5	37.8			20	23					MLG1005S33NHDT25
33.5	37.8			20	23					MLG1005S33NJTD25
36.7	41.5			21	23					MLG1005S36NHDT25
36.7	41.5			21	23					MLG1005S36NJTD25
40.3	46.9			20	21					MLG1005S39NHDT25
40.3	46.9			20	21					MLG1005S39NJTD25
44.3	51.6			20	21					MLG1005S43NHDT25
44.3	51.6			20	21					MLG1005S43NJTD25
50.2	63.2			19	20					MLG1005S47NHDT25
50.2	63.2			19	20					MLG1005S47NJTD25
53.7	65.6			19	19					MLG1005S51NHDT25
53.7	65.6			19	19					MLG1005S51NJTD25
60.9	80.2			19	18					MLG1005S56NHDT25
60.9	80.2			19	18					MLG1005S56NJTD25
67.5	89.8			18	16					MLG1005S62NHDT25
67.5	89.8			18	16					MLG1005S62NJTD25
75.8	107.5			17	15					MLG1005S68NHDT25
75.8	107.5			17	15					MLG1005S68NJTD25
86.5	135.2			17	13					MLG1005S75NHDT25
86.5	135.2			17	13					MLG1005S75NJTD25
96.9				16						MLG1005S82NHDT25
96.9				16						MLG1005S82NJTD25
111.0				15						MLG1005S91NHDT25
111.0				15						MLG1005S91NJTD25

* Please contact us for information on inductance tolerance, G ($\pm 2\%$).

Measurement equipment

Product No.	Manufacturer
4291B +16193A	Keysight Technologies

* Equivalent measurement equipment may be used.

MLG1005S type

L, Q FREQUENCY CHARACTERISTICS TABLE

L(nH)typ.					Q typ.					Part No.*
500MHz	800MHz	1.8GHz	2.0GHz	2.4GHz	500MHz	800MHz	1.8GHz	2.0GHz	2.4GHz	
128.9					14					MLG1005SR10HTD25
128.9					14					MLG1005SR10JTD25
140.8					15					MLG1005SR11HTD25
140.8					15					MLG1005SR11JTD25
175.2					12					MLG1005SR12HTD25
175.2					12					MLG1005SR12JTD25
187.8					13					MLG1005SR13HTD25
187.8					13					MLG1005SR13JTD25
284.7					11					MLG1005SR15HTD25
284.7					11					MLG1005SR15JTD25
										MLG1005SR16HTD25
										MLG1005SR16JTD25
										MLG1005SR18HTD25
										MLG1005SR18JTD25
										MLG1005SR20HTD25
										MLG1005SR20JTD25
										MLG1005SR22HTD25
										MLG1005SR22JTD25
										MLG1005SR24HTD25
										MLG1005SR24JTD25
										MLG1005SR27HTD25
										MLG1005SR27JTD25
										MLG1005SR30HTD25
										MLG1005SR30JTD25
										MLG1005SR33HTD25
										MLG1005SR33JTD25
										MLG1005SR36HTD25
										MLG1005SR36JTD25
										MLG1005SR39HTD25
										MLG1005SR39JTD25

* Please contact us for information on inductance tolerance, G ($\pm 2\%$).

Measurement equipment

Product No.	Manufacturer
4291B +16193A	Keysight Technologies

* Equivalent measurement equipment may be used.

MLG1005S type

■ L FREQUENCY CHARACTERISTICS (EXAMPLE)

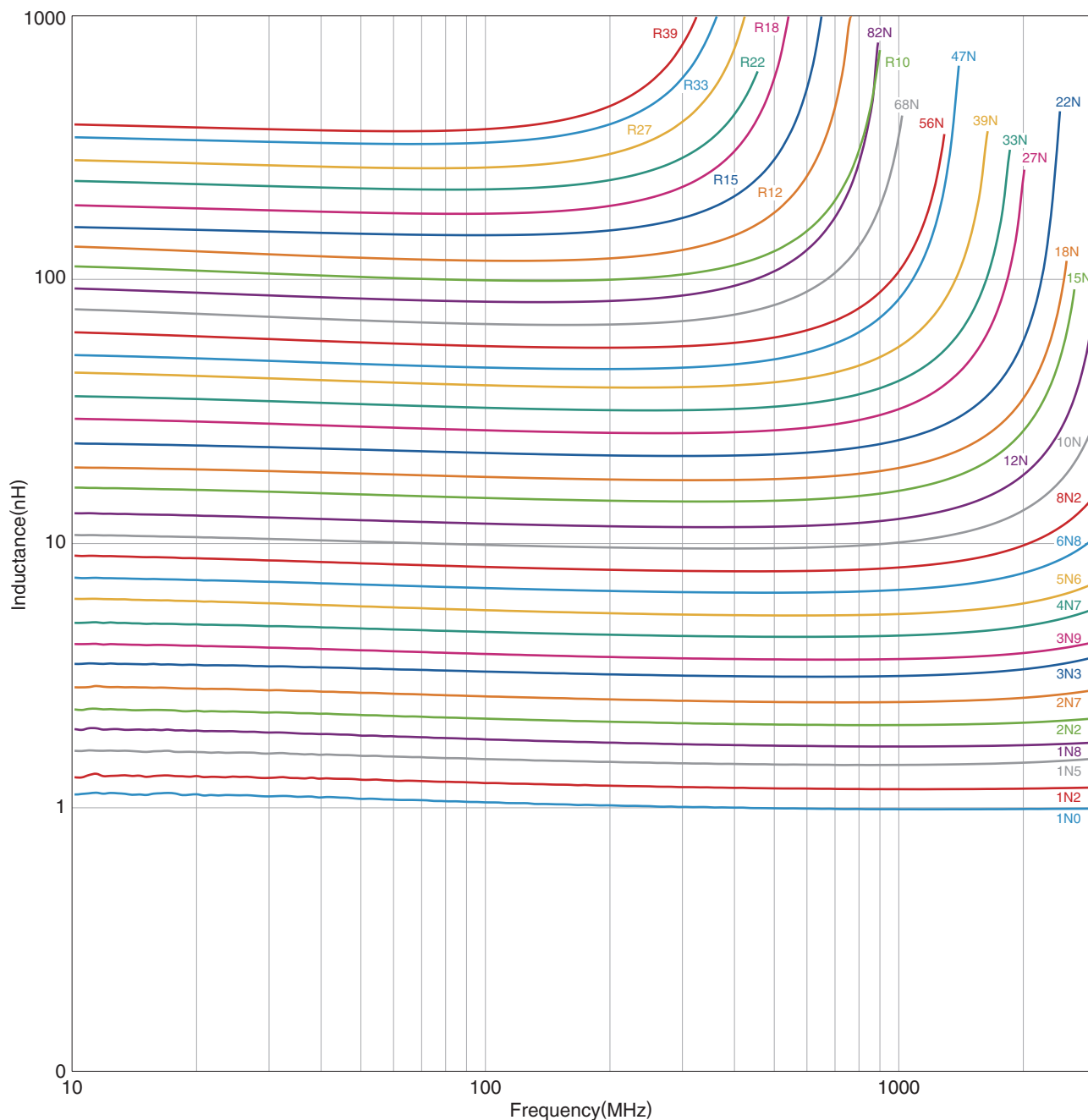

Measurement equipment

Product No.	Manufacturer
E4991A +16193A	Keysight Technologies

* Equivalent measurement equipment may be used.

MLG1005S type

Q FREQUENCY CHARACTERISTICS (EXAMPLE)

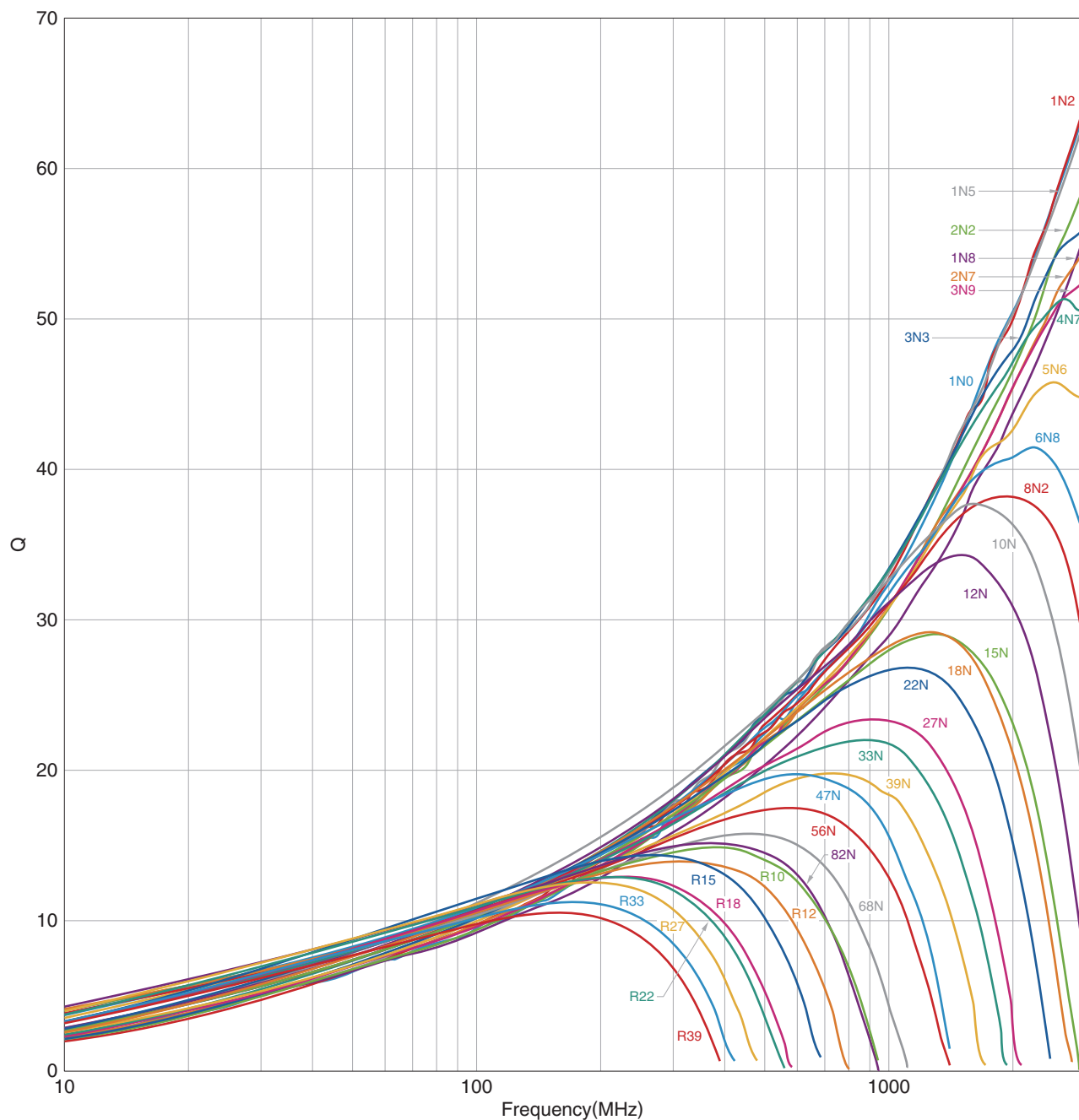

Measurement equipment

Product No.	Manufacturer
E4991A +16193A	Keysight Technologies

* Equivalent measurement equipment may be used.

MLG1005S type

SHAPE & DIMENSIONS

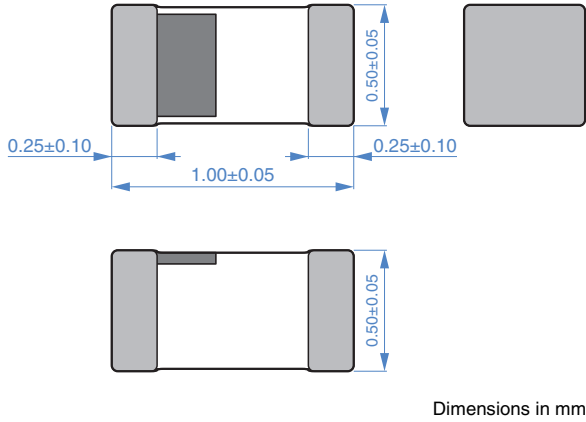

PACKAGING STYLE

REEL DIMENSIONS

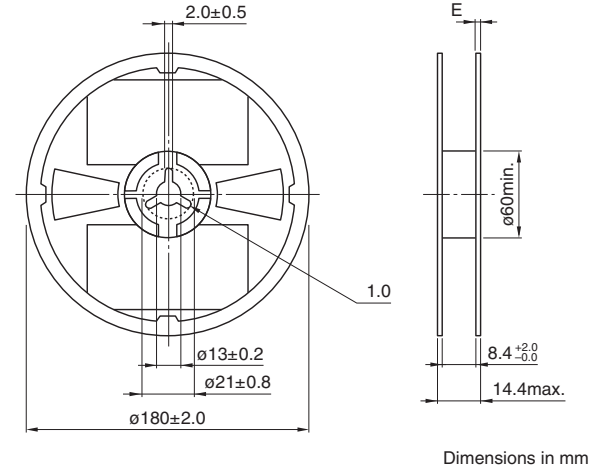

RECOMMENDED LAND PATTERN

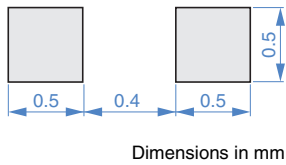

TAPE DIMENSIONS

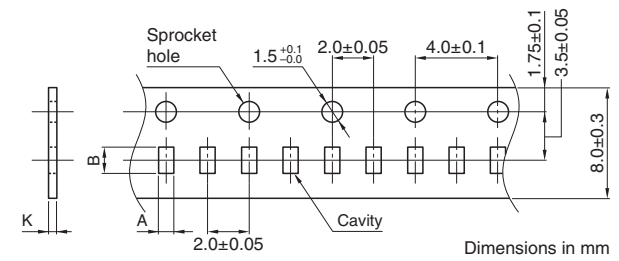

RECOMMENDED REFLOW PROFILE

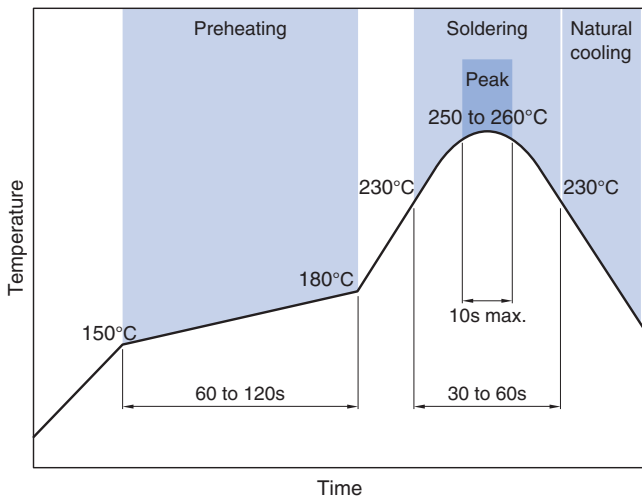

Type	A	B	K
MLG1005S	0.62±0.1	1.12±0.1	0.8 max.

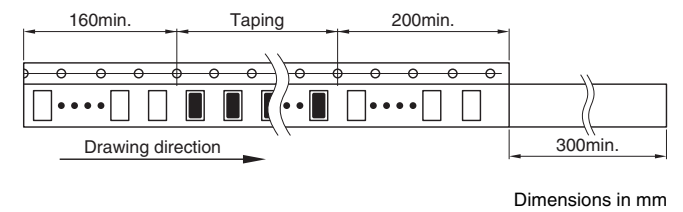

PACKAGE QUANTITY

Package quantity	10000pcs/reel
------------------	---------------

TEMPERATURE RANGE, INDIVIDUAL WEIGHT

Operating temperature range	Storage temperature range*	Individual weight
-55 to +125 °C	-55 to +125 °C	1 mg

* The storage temperature range is for after the assembly.

REMINDERS FOR USING THESE PRODUCTS

Before using these products, be sure to request the delivery specifications.

SAFETY REMINDERS

Please pay sufficient attention to the warnings for safe designing when using this products.

REMINDERS

- The storage period is less than 12 months. Be sure to follow the storage conditions (temperature: 5 to 40°C, humidity: 10 to 75% RH or less).
If the storage period elapses, the soldering of the terminal electrodes may deteriorate.
- Do not use or store in locations where there are conditions such as gas corrosion (salt, acid, alkali, etc.).
- Before soldering, be sure to preheat components.
The preheating temperature should be set so that the temperature difference between the solder temperature and chip temperature does not exceed 150°C.
- Soldering corrections after mounting should be within the range of the conditions determined in the specifications.
If overheated, a short circuit, performance deterioration, or lifespan shortening may occur.
- When embedding a printed circuit board where a chip is mounted to a set, be sure that residual stress is not given to the chip due to the overall distortion of the printed circuit board and partial distortion such as at screw tightening portions.
- Self heating (temperature increase) occurs when the power is turned ON, so the tolerance should be sufficient for the set thermal design.
- Carefully lay out the coil for the circuit board design of the non-magnetic shield type.
A malfunction may occur due to magnetic interference.
- Use a wrist band to discharge static electricity in your body through the grounding wire.
- Do not expose the products to magnets or magnetic fields.
- Do not use for a purpose outside of the contents regulated in the delivery specifications.
- The products listed on this catalog are intended for use in general electronic equipment (AV equipment, telecommunications equipment, home appliances, amusement equipment, computer equipment, personal equipment, office equipment, measurement equipment, industrial robots) under a normal operation and use condition.
The products are not designed or warranted to meet the requirements of the applications listed below, whose performance and/or quality require a more stringent level of safety or reliability, or whose failure, malfunction or trouble could cause serious damage to society, person or property.
If you intend to use the products in the applications listed below or if you have special requirements exceeding the range or conditions set forth in the each catalog, please contact us.

- (1) Aerospace/aviation equipment
- (2) Transportation equipment (electric trains, ships, etc.)
- (3) Medical equipment
- (4) Power-generation control equipment
- (5) Atomic energy-related equipment
- (6) Seabed equipment
- (7) Transportation control equipment

- (8) Public information-processing equipment
- (9) Military equipment
- (10) Electric heating apparatus, burning equipment
- (11) Disaster prevention/crime prevention equipment
- (12) Safety equipment
- (13) Other applications that are not considered general-purpose applications

When designing your equipment even for general-purpose applications, you are kindly requested to take into consideration securing protection circuit/device or providing backup circuits in your equipment.

X-ON Electronics

Largest Supplier of Electrical and Electronic Components

Click to view similar products for [RF inductors - SMD category](#):

Click to view products by [TDK manufacturer](#):

Other Similar products are found below :

[B82498B1332J000](#) [B82498B3121J000](#) [0805WL220GT](#) [1008WL101GT](#) [0805WL681GT](#) [IWC0402D27NR-3G](#) [IWC0603F68NR-3G](#)
[IWC0402AR10R-3G](#) [IWC0402D33NR-3G](#) [IWC0603F47NR-3G](#) [0805WL151JT](#) [IWC0402A68NR-3G](#) [IWC0402AR12R-3G](#) [0805WL181JT](#)
[IWC0402A82NR-3G](#) [IWC0402B39NR-3G](#) [IWC0603CR12R-3G](#) [IWC0603AR33R-3G](#) [IWC0603BR18R-3G](#) [IWC0603F39NR-3G](#)
[IWC0603BR22R-3G](#) [IWC0402A47NR-3G](#) [IWC0603AR27R-3G](#) [IWC0603F27NR-3G](#) [0603WL391GT](#) [IWC1008DR68R-3G](#)
[IWC1008FR12R-3G](#) [IWC1008FR18R-3G](#) [IWC1008J33NR-3G](#) [IWC1008J82NR-3G](#) [IWC1008DR47R-3G](#) [IWC1008J18NR-3G](#)
[IWC0805E22NR-3G](#) [IWC1008DR82R-3G](#) [IWC0805E33NR-3G](#) [IWC1008J68NR-3G](#) [IWC0805D82NR-3G](#) [IWC0805DR10R-3G](#)
[IWC0805E39NR-3G](#) [IWC1008DR39R-3G](#) [IWC0805DR15R-3G](#) [IWC1008J39NR-3G](#) [IWC1008J27NR-3G](#) [IWC0805DR18R-3G](#)
[IWC0805E68NR-3G](#) [IWC1008ER27R-3G](#) [IWC1008FR10R-3G](#) [IWC1008J22NR-3G](#) [CS0402-11NJ-S](#) [CS0402-82NJ-S](#)