

Inductors for decoupling circuits

Multilayer ferrite

MLZ series



MLZ2012 type



FEATURES

- The MLZ series include inductors for decoupling circuits that have top-class DC superimposition characteristics and low DC resistance.
- They are compatible with wide frequency band noise, from low to high frequency.
- H type products have a rated current that is equivalent to that of wound coils.
- W type products are the new standard type products that have both large current and low resistance.
- L type products have a resistance up to 60% lower than W type products.
- Operating temperature range: -55 to +125°C (including self-temperature rise)

APPLICATION

- Smart phones, tablet terminals, note PCs, various modules such as camera modules, DSCs, video games, portable memory audio devices, navigation systems, PNDs, WLANs, SSDs
- Application guides: [Smart phones/tablets](#)

PART NUMBER CONSTRUCTION

MLZ	2012	M	1R0	H	T	000
Series name	L×W×H dimensions 2.0×1.25×0.85 mm 2.0×1.25×1.25 mm	Product internal code	Inductance (μH)	Characteristic type	Packaging style	Internal code

CHARACTERISTICS SPECIFICATION TABLE

Type	L (μH)	Thickness T (mm)	L measuring conditions		DC resistance (Ω)±30%	Isat*1 (mA)	Itemp*2 (mA)	Part No.	
			Frequency (MHz)	Current (mA)					
Ultra-large current	1.0	±20%	1.25	2	0.1	0.10	700	800	MLZ2012M1R0HT000
	1.5	±20%	1.25	2	0.1	0.14	550	700	MLZ2012M1R5HT000
	2.2	±20%	1.25	2	0.1	0.16	400	600	MLZ2012M2R2HT000
	3.3	±20%	1.25	2	0.1	0.20	350	500	MLZ2012M3R3HT000
	4.7	±20%	1.25	2	0.1	0.34	300	400	MLZ2012M4R7HT000
	6.8	±20%	1.25	2	0.1	0.40	220	350	MLZ2012M6R8HT000
High frequency	10	±20%	1.25	2	0.1	0.68	200	300	MLZ2012M100HT000
	0.10	±20%	0.85	25	1.0	0.07	1000	1150	MLZ2012DR10DT000
	0.22	±20%	0.85	25	1.0	0.13	800	900	MLZ2012DR22DT000
	0.47	±20%	1.25	25	1.0	0.18	550	700	MLZ2012DR47DT000

*1 Current assumed when inductance ratio has decreased by 50% max..

*2 Current assumed when temperature has risen to 20°C max. (reference value). Operating temperature environment at this time: 105°C max.

Measurement equipment

Measurement item	Product No.	Manufacturer
L	4294A+16034G	Keysight Technologies
DC resistance	Type-7561	Yokogawa

* Equivalent measurement equipment may be used.

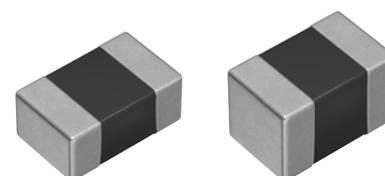

MLZ2012 type

CHARACTERISTICS SPECIFICATION TABLE

Type	L		Thickness T (mm)	L measuring conditions		DC resistance (Ω) \pm 30%	Isat* ¹ (mA)	Itemp* ² (mA)	Part No.
	(μ H)	Tolerance		Frequency (MHz)	Current (mA)				
Large current	1.00	\pm 20%	0.85	10	1.0	0.10	280	900	MLZ2012A1R0WT000
	1.50	\pm 20%	0.85	10	1.0	0.13	250	750	MLZ2012A1R5WT000
	2.20	\pm 20%	0.85	10	1.0	0.15	210	650	MLZ2012A2R2WT000
	3.30	\pm 20%	0.85	10	1.0	0.34	200	450	MLZ2012A3R3WT000
	4.70	\pm 20%	0.85	2	0.1	0.30	180	500	MLZ2012M4R7WT000
	6.80	\pm 20%	1.25	2	0.1	0.40	160	400	MLZ2012M6R8WT000
	10.0	\pm 20%	1.25	2	0.1	0.47	150	350	MLZ2012M100WT000
	15.0	\pm 20%	1.25	2	0.1	0.95	120	250	MLZ2012M150WT000
	22.0	\pm 20%	1.25	2	0.1	1.25	100	220	MLZ2012P220WT000
	22.0	\pm 20%	1.25	2	0.1	2.0	60	220	MLZ2012M220WT000
Low resistance	33.0	\pm 20%	1.25	2	0.1	2.60	55	190	MLZ2012M330WT000
	47.0	\pm 20%	1.25	2	0.1	3.70	50	170	MLZ2012M470WT000
	1.00	\pm 20%	0.85	2	0.1	0.06	220	1150	MLZ2012N1R0LT000
	1.50	\pm 20%	0.85	2	0.1	0.10	190	900	MLZ2012N1R5LT000
	2.20	\pm 20%	0.85	2	0.1	0.12	170	800	MLZ2012N2R2LT000
	3.30	\pm 20%	0.85	2	0.1	0.15	130	750	MLZ2012N3R3LT000
	4.70	\pm 20%	0.85	2	0.1	0.18	130	600	MLZ2012N4R7LT000
	6.80	\pm 20%	0.85	2	0.1	0.25	110	550	MLZ2012N6R8LT000
	10.0	\pm 20%	1.25	2	0.1	0.30	110	500	MLZ2012N100LT000
	15.0	\pm 20%	1.25	2	0.1	0.47	90	350	MLZ2012N150LT000
22.0	\pm 20%	1.25	2	0.1	0.67	70	300	MLZ2012N220LT000	
100.0	\pm 20%	1.25	2	0.1	3.50	30	140	MLZ2012N101LT000	

*¹ Current assumed when inductance ratio has decreased by 50% max..

*² Current assumed when temperature has risen to 20°C max. (reference value). Operating temperature environment at this time: 105°C max.

Measurement equipment

Measurement item	Product No.	Manufacturer
L	4294A+16034G	Keysight Technologies
DC resistance	Type-7561	Yokogawa

* Equivalent measurement equipment may be used.

MLZ2012 type

L FREQUENCY CHARACTERISTICS H CHARACTERISTIC PRODUCT

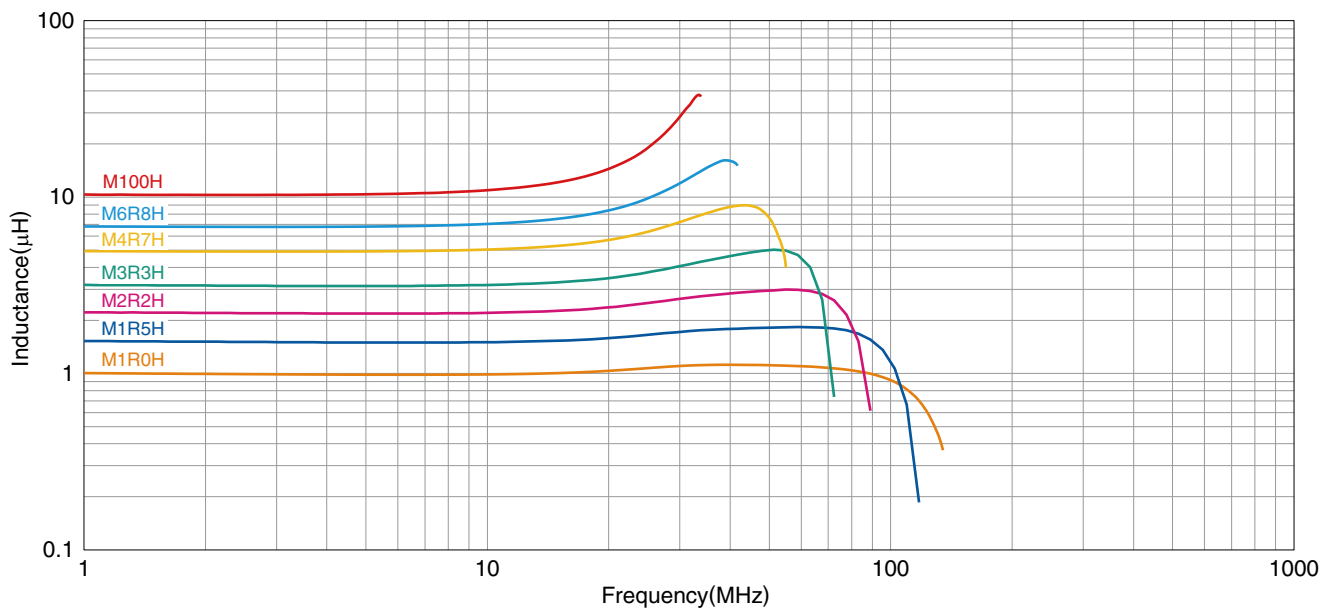

Measurement equipment

Product No.	Manufacturer
E4991A+16192A	Keysight Technologies

* Equivalent measurement equipment may be used.

L FREQUENCY CHARACTERISTICS D CHARACTERISTIC PRODUCT

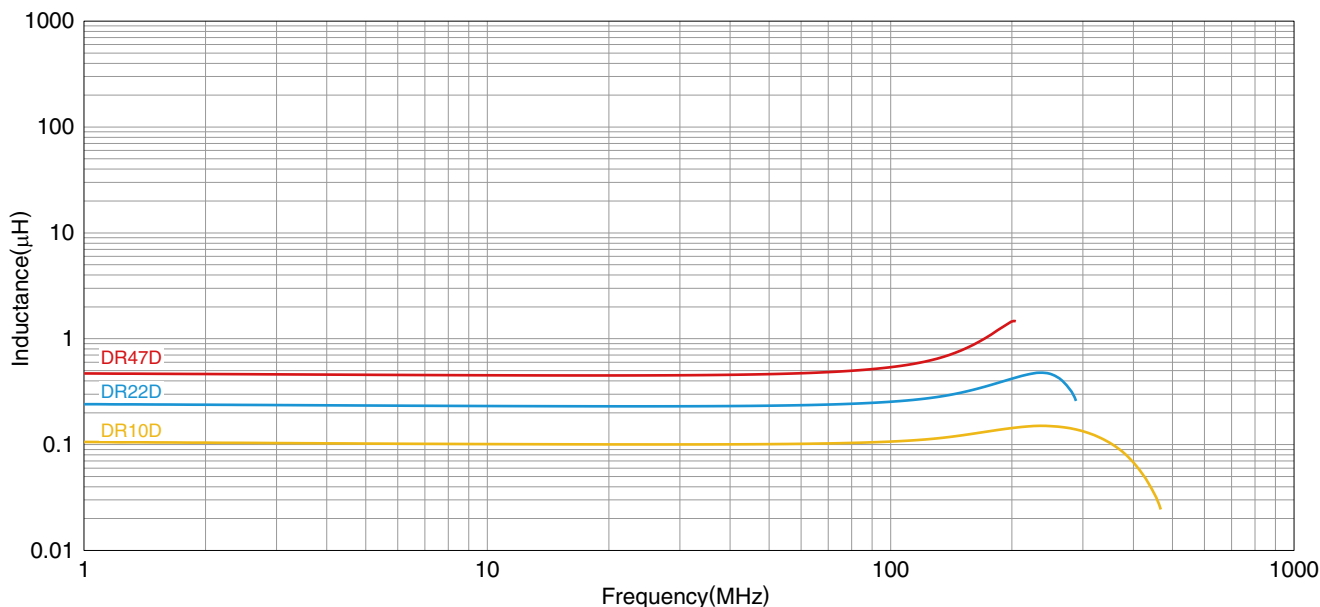

Measurement equipment

Product No.	Manufacturer
E4991A+16192A	Keysight Technologies

* Equivalent measurement equipment may be used.

MLZ2012 type

■ L FREQUENCY CHARACTERISTICS W CHARACTERISTIC PRODUCT

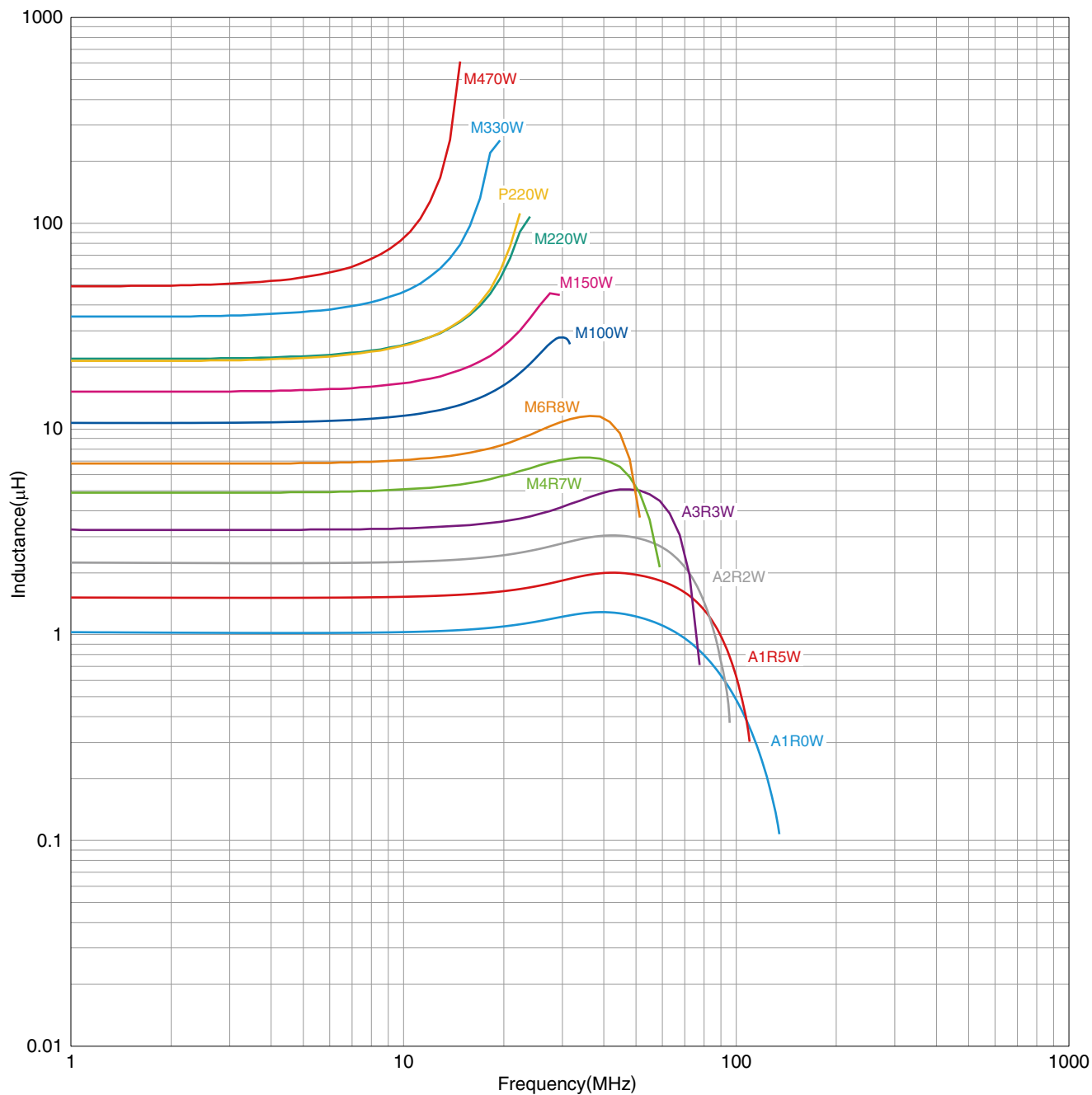

Measurement equipment

Product No.	Manufacturer
4291B+16200A+16192A	Keysight Technologies

* Equivalent measurement equipment may be used.

MLZ2012 type

■ L FREQUENCY CHARACTERISTICS L CHARACTERISTIC PRODUCT

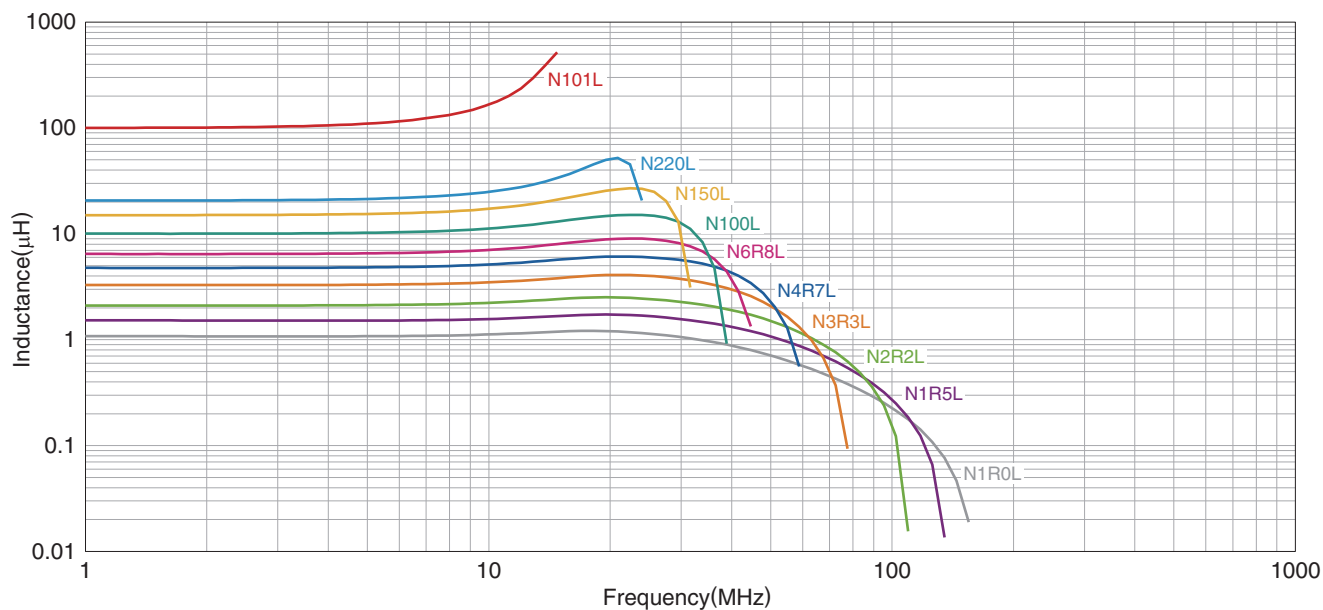

Measurement equipment

Product No.	Manufacturer
E4991A+16192A	Keysight Technologies

* Equivalent measurement equipment may be used.

MLZ2012 type

INDUCTANCE VS. DC BIAS CHARACTERISTICS H CHARACTERISTIC PRODUCT

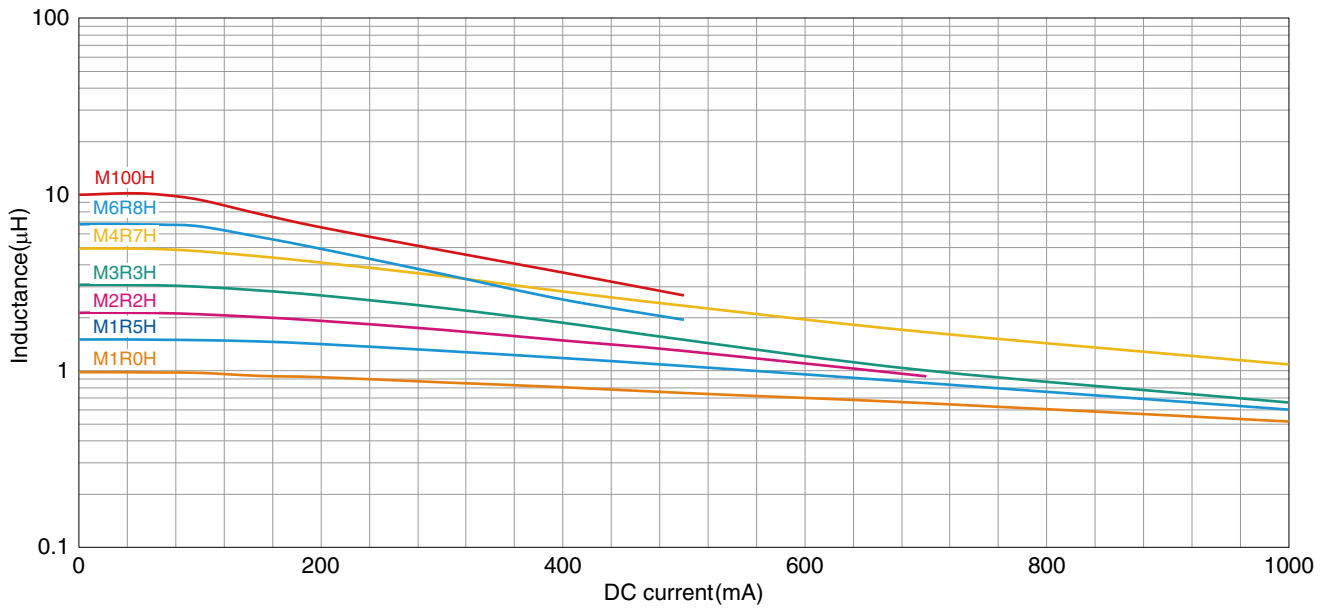

Measurement equipment

Product No.	Manufacturer
4291B+16200A+16192A	Keysight Technologies

* Equivalent measurement equipment may be used.

INDUCTANCE VS. DC BIAS CHARACTERISTICS D CHARACTERISTIC PRODUCT

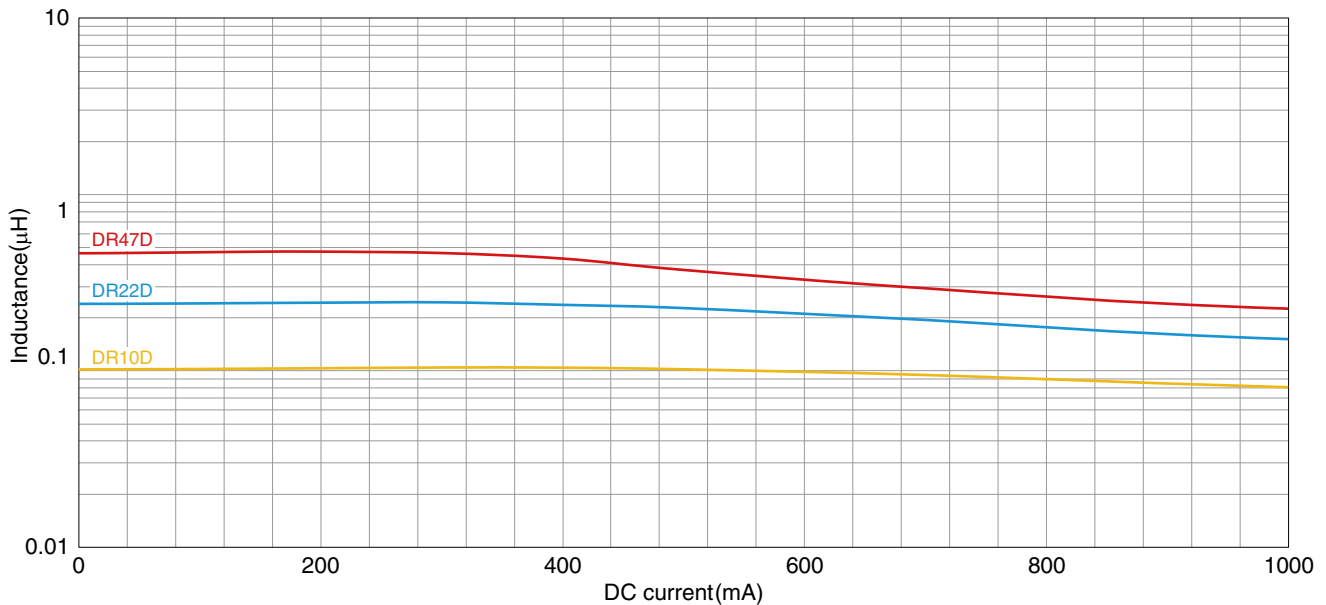

Measurement equipment

Product No.	Manufacturer
4291B+16200A+16192A	Keysight Technologies

* Equivalent measurement equipment may be used.

MLZ2012 type

INDUCTANCE VS. DC BIAS CHARACTERISTICS W CHARACTERISTIC PRODUCT

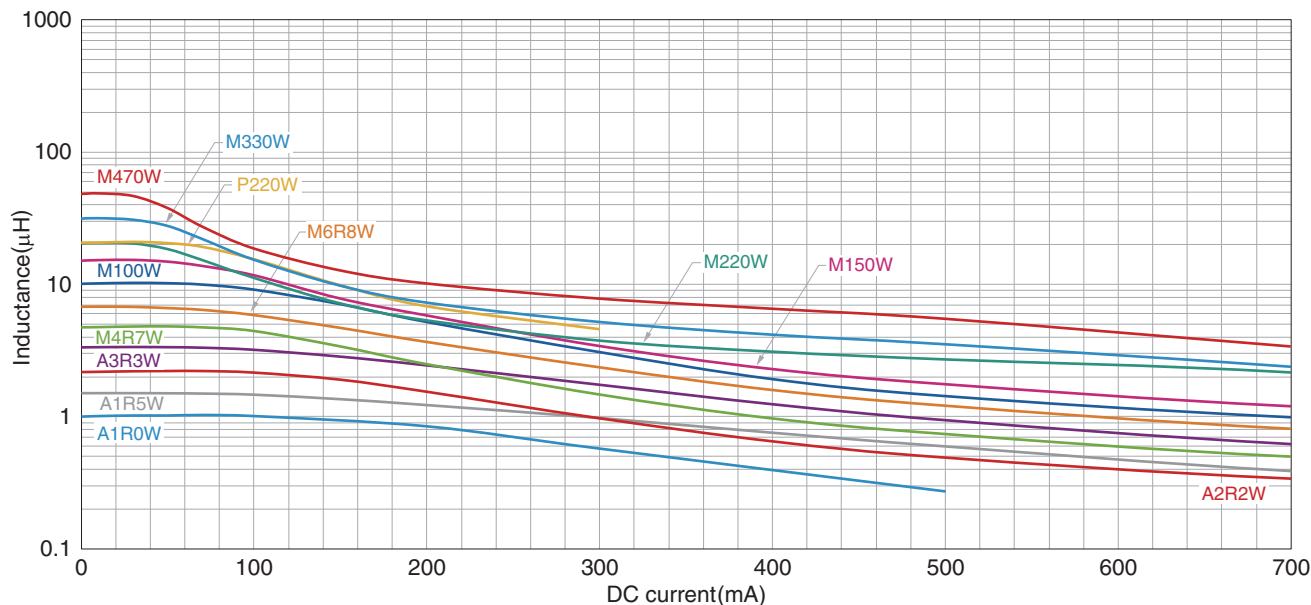

Measurement equipment

Product No.	Manufacturer
4291B+16200A+16192A	Keysight Technologies

* Equivalent measurement equipment may be used.

INDUCTANCE VS. DC BIAS CHARACTERISTICS L CHARACTERISTIC PRODUCT

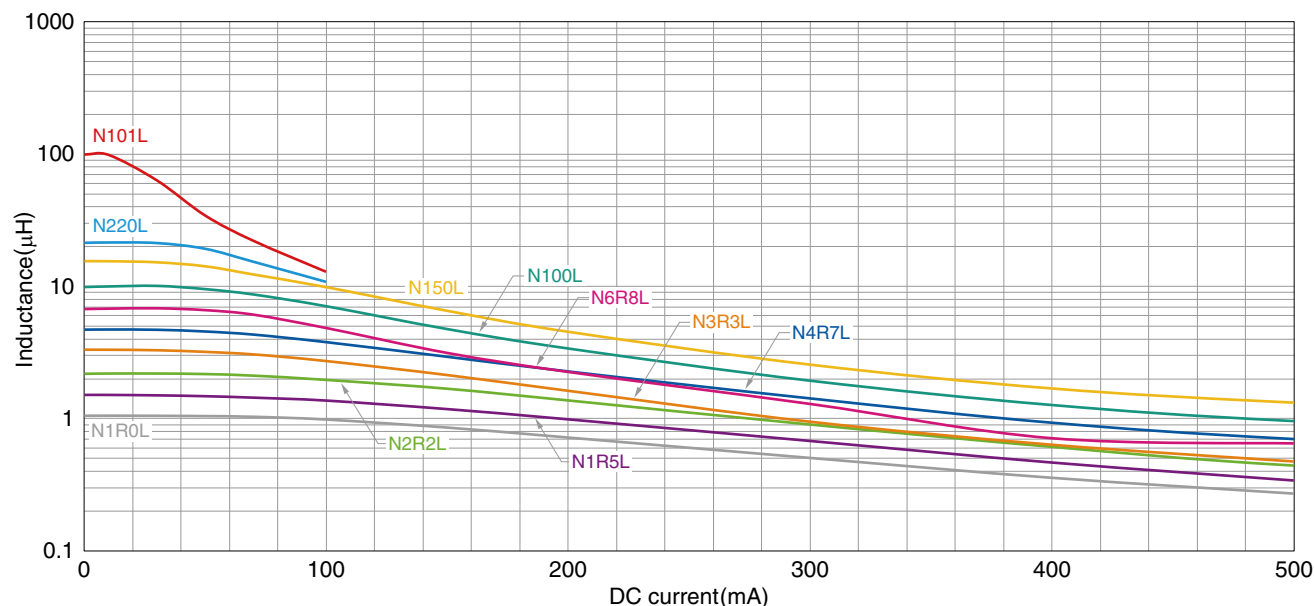

Measurement equipment

Product No.	Manufacturer
4291B+16200A+16192A	Keysight Technologies

* Equivalent measurement equipment may be used.

MLZ2012 type

■ IMPEDANCE FREQUENCY CHARACTERISTICS H CHARACTERISTIC PRODUCT

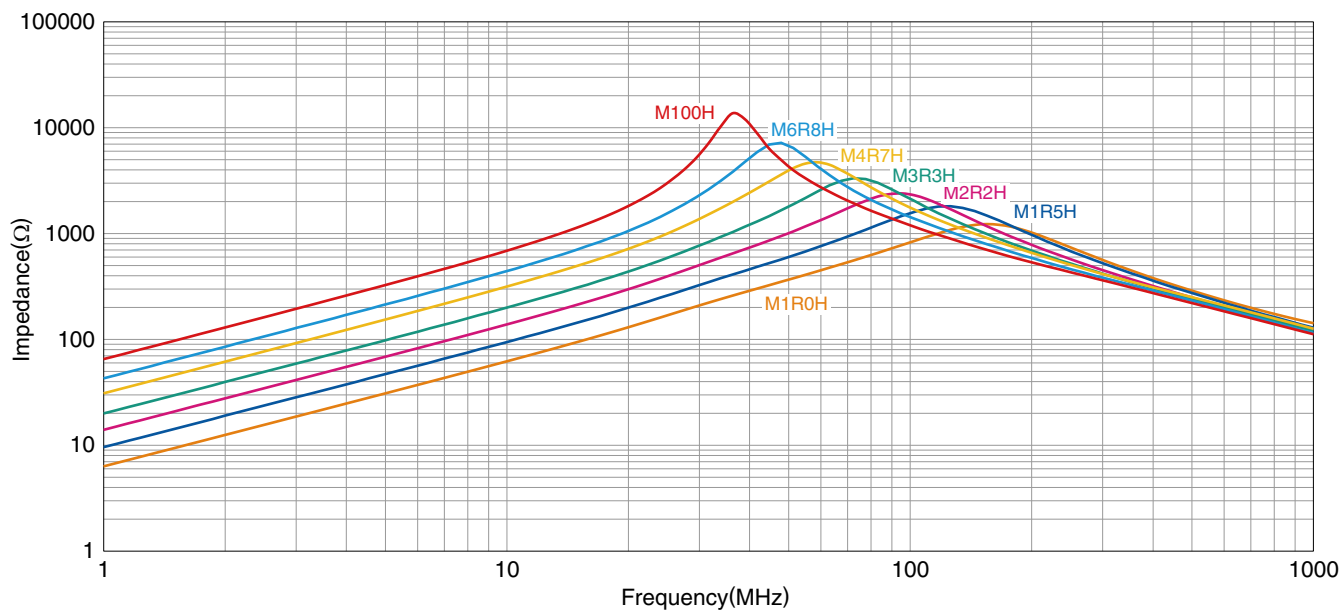

Measurement equipment

Product No.	Manufacturer
E4991A+16192A	Keysight Technologies

* Equivalent measurement equipment may be used.

■ IMPEDANCE FREQUENCY CHARACTERISTICS D CHARACTERISTIC PRODUCT

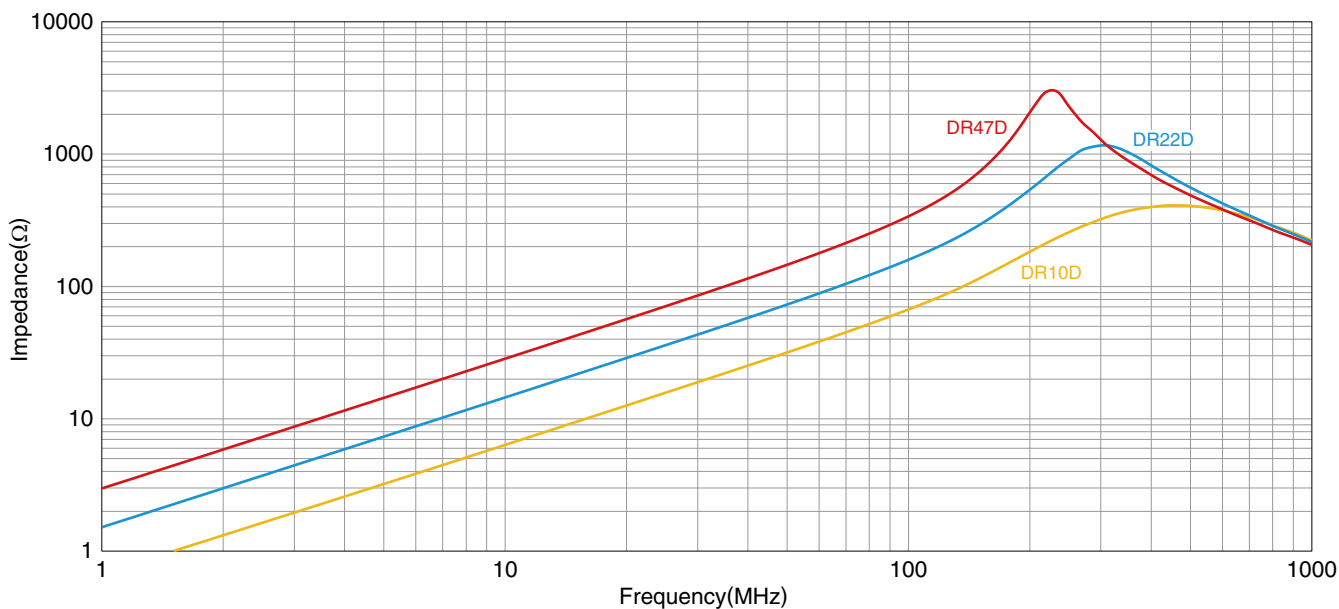

Measurement equipment

Product No.	Manufacturer
E4991A+16192A	Keysight Technologies

* Equivalent measurement equipment may be used.

MLZ2012 type

■ IMPEDANCE FREQUENCY CHARACTERISTICS W CHARACTERISTIC PRODUCT

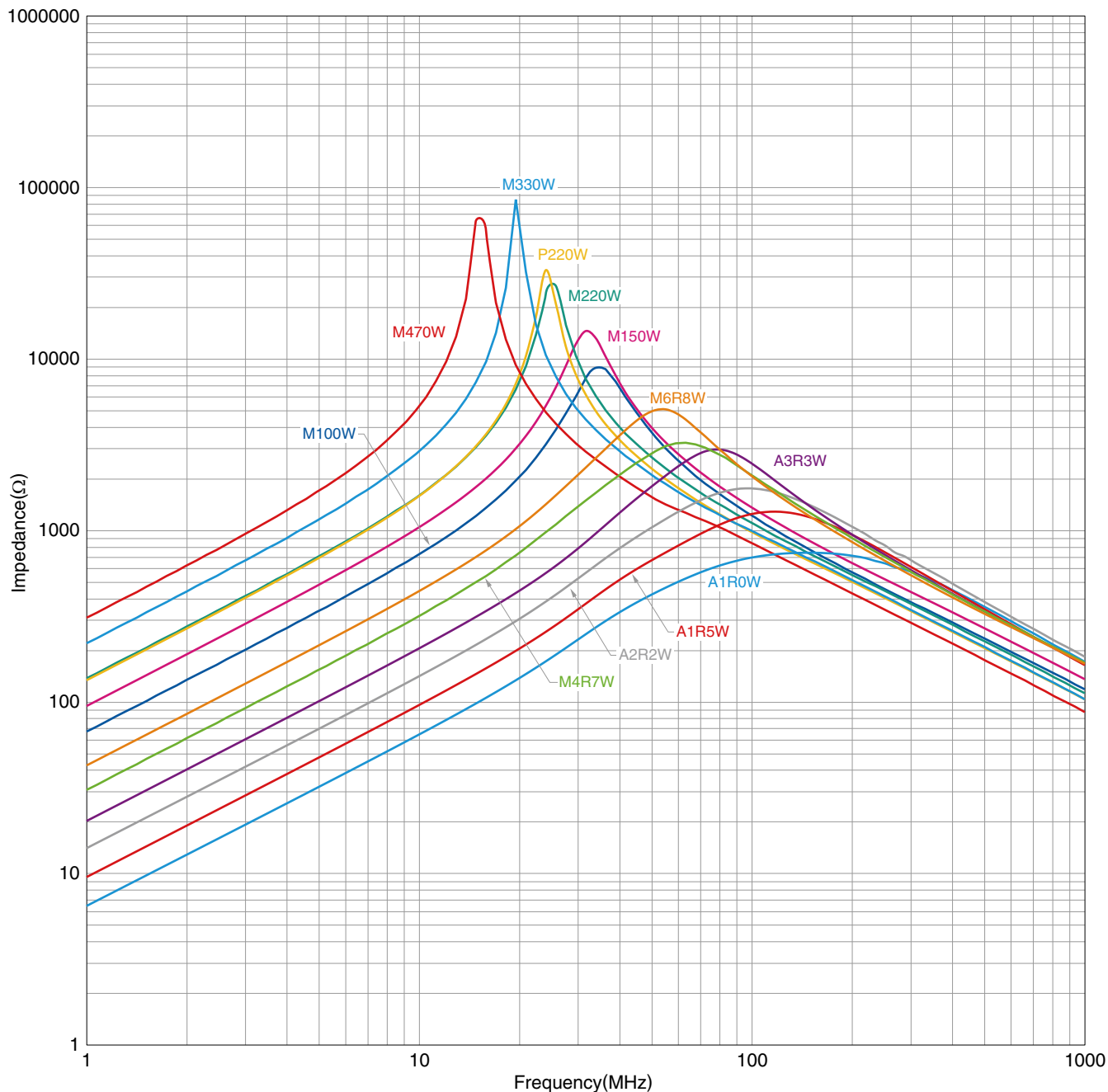

Measurement equipment

Product No.	Manufacturer
E4991A+16192A	Keysight Technologies

* Equivalent measurement equipment may be used.

MLZ2012 type

■ IMPEDANCE FREQUENCY CHARACTERISTICS L CHARACTERISTIC PRODUCT

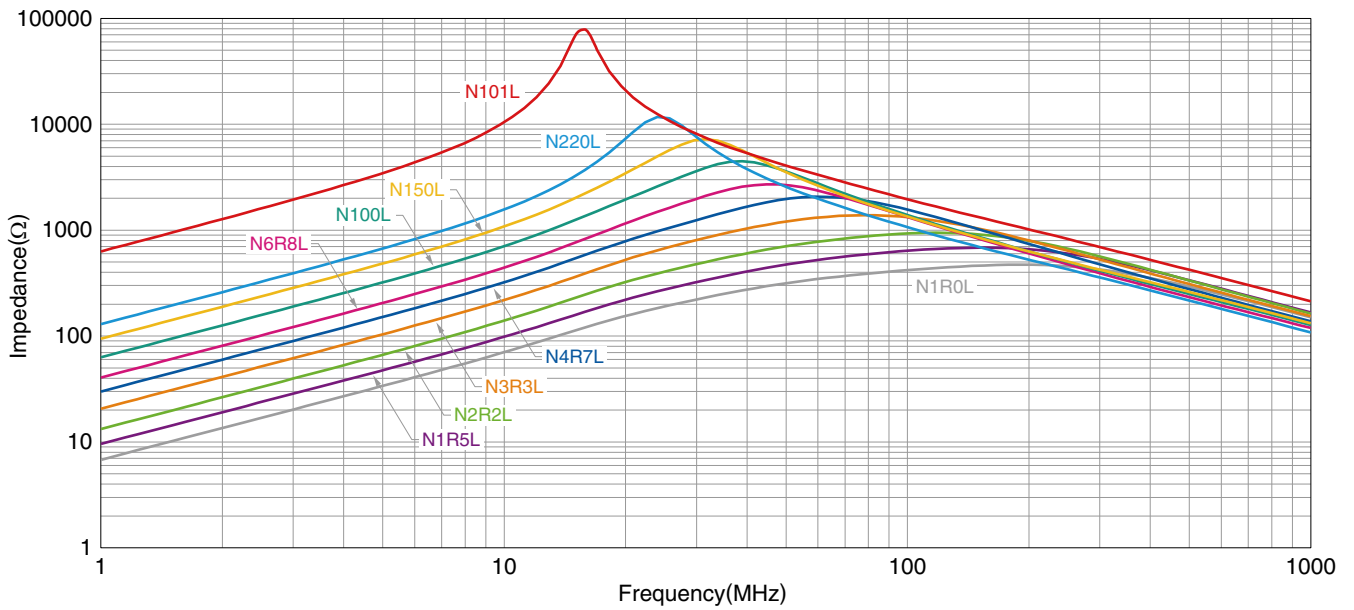

Measurement equipment

Product No.	Manufacturer
E4991A+16192A	Keysight Technologies

* Equivalent measurement equipment may be used.

MLZ2012 type

SHAPE & DIMENSIONS

t=0.85mm

t=1.25mm

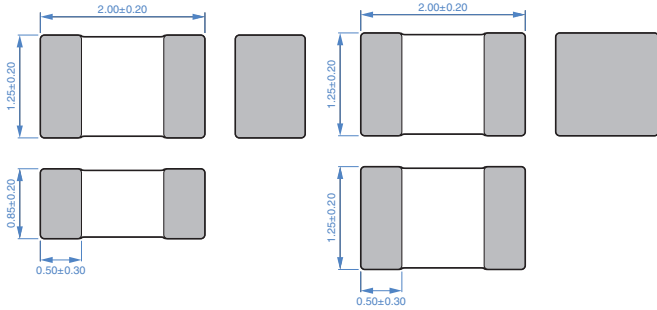

Dimensions in mm

PACKAGING STYLE

REEL DIMENSIONS

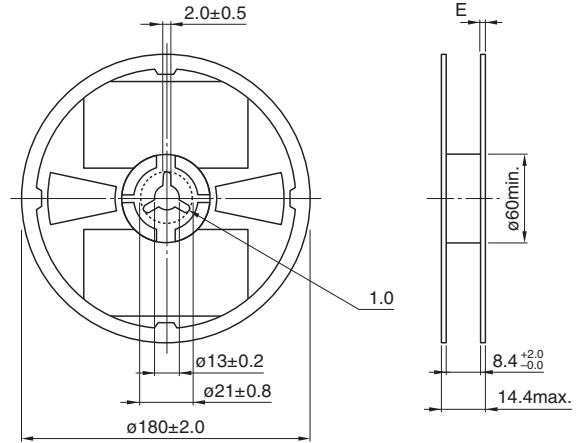

Dimensions in mm

RECOMMENDED LAND PATTERN

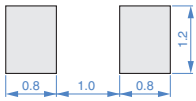

Dimensions in mm

TAPE DIMENSIONS

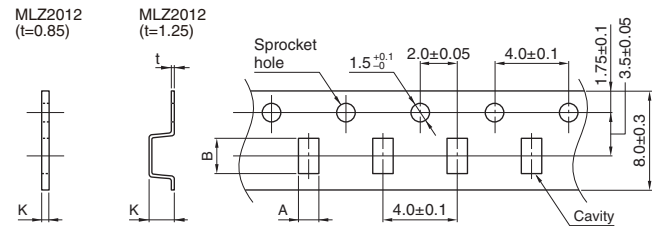

Dimensions in mm

Type	A	B	K	
MLZ2012	t=0.85	1.5±0.2	2.3±0.2	1.1 max.
	t=1.25	1.5±0.2	2.3±0.2	1.5 max.

RECOMMENDED REFLOW PROFILE

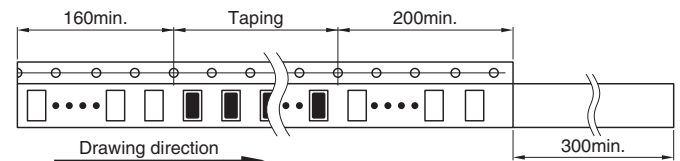
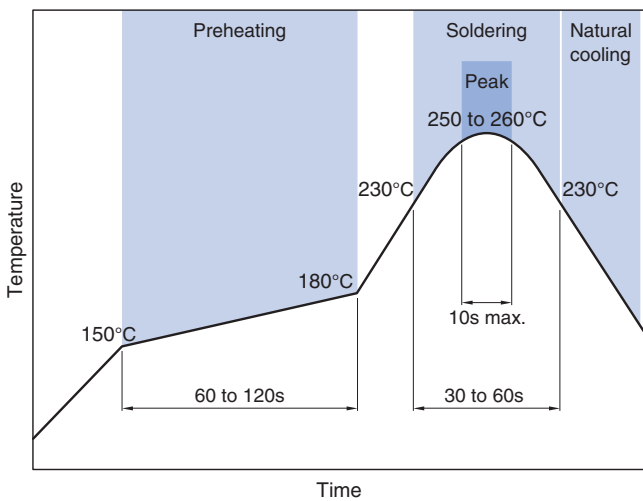

Dimensions in mm

PACKAGE QUANTITY

Package quantity	t=0.85mm	t=1.25mm
	4000 pcs/reel	2000 pcs/reel

TEMPERATURE RANGE, INDIVIDUAL WEIGHT

Type	Operating temperature range*	Storage temperature range**	Individual weight
t=0.85mm	-55 to +125 °C	-55 to +125 °C	10 mg
t=1.25mm	-55 to +125 °C	-55 to +125 °C	14 mg

* Operating temperature range includes self-temperature rise.

** The storage temperature range is for after the assembly.

REMINDERS FOR USING THESE PRODUCTS

Before using these products, be sure to request the delivery specifications.

SAFETY REMINDERS

Please pay sufficient attention to the warnings for safe designing when using this products.

REMINDERS

- The storage period is less than 12 months. Be sure to follow the storage conditions (temperature: 5 to 40°C, humidity: 10 to 75% RH or less).
If the storage period elapses, the soldering of the terminal electrodes may deteriorate.
- Do not use or store in locations where there are conditions such as gas corrosion (salt, acid, alkali, etc.).
- Before soldering, be sure to preheat components.
The preheating temperature should be set so that the temperature difference between the solder temperature and chip temperature does not exceed 150°C.
- Soldering corrections after mounting should be within the range of the conditions determined in the specifications.
If overheated, a short circuit, performance deterioration, or lifespan shortening may occur.
- When embedding a printed circuit board where a chip is mounted to a set, be sure that residual stress is not given to the chip due to the overall distortion of the printed circuit board and partial distortion such as at screw tightening portions.
- Self heating (temperature increase) occurs when the power is turned ON, so the tolerance should be sufficient for the set thermal design.
- Carefully lay out the coil for the circuit board design of the non-magnetic shield type.
A malfunction may occur due to magnetic interference.
- Use a wrist band to discharge static electricity in your body through the grounding wire.
- Do not expose the products to magnets or magnetic fields.
- Do not use for a purpose outside of the contents regulated in the delivery specifications.
- The products listed on this catalog are intended for use in general electronic equipment (AV equipment, telecommunications equipment, home appliances, amusement equipment, computer equipment, personal equipment, office equipment, measurement equipment, industrial robots) under a normal operation and use condition.
The products are not designed or warranted to meet the requirements of the applications listed below, whose performance and/or quality require a more stringent level of safety or reliability, or whose failure, malfunction or trouble could cause serious damage to society, person or property.
If you intend to use the products in the applications listed below or if you have special requirements exceeding the range or conditions set forth in the each catalog, please contact us.

- (1) Aerospace/aviation equipment
- (2) Transportation equipment (cars, electric trains, ships, etc.)
- (3) Medical equipment
- (4) Power-generation control equipment
- (5) Atomic energy-related equipment
- (6) Seabed equipment
- (7) Transportation control equipment

- (8) Public information-processing equipment
- (9) Military equipment
- (10) Electric heating apparatus, burning equipment
- (11) Disaster prevention/crime prevention equipment
- (12) Safety equipment
- (13) Other applications that are not considered general-purpose applications

When designing your equipment even for general-purpose applications, you are kindly requested to take into consideration securing protection circuit/device or providing backup circuits in your equipment.

X-ON Electronics

Largest Supplier of Electrical and Electronic Components

Click to view similar products for [Ferrite Beads](#) category:

Click to view products by [TDK](#) manufacturer:

Other Similar products are found below :

[2943778301](#) [BMB1J0120BN3JIT](#) [82350120560](#) [0261014605](#) [2643066902](#) [3061000011](#) [2673045901](#) [2643083601](#) [2643074901](#) [4361142521](#)
[4078078621](#) [4078044821](#) [4078033621](#) [CZB2BFTTE121P](#) [BMB2A0120AN2](#) [BMB1J0200BN3JIT](#) [EMI0805R-220](#) [74279250](#) [7427924](#)
[CZB1JGTTD202P](#) [MAF0603GWY551AT000](#) [MAF1005GWZ102AT000](#) [BLM18HE152SH1D](#) [2944778302](#) [BLM02PX600SN1D](#) [SMB2.5-1](#)
[EMI1206R-600](#) [BLM02KX180SN1D](#) [BLM02BC100SN1D](#) [BLM02KX100SN1D](#) [BLM02BB101SN1D](#) [BLM02BC220SN1D](#)
[BLE32PN260SH1L](#) [BLE32PN260SN1L](#) [BLE32PN260SZ1L](#) [74275013](#) [7427503](#) [BLM18HE601SH1D](#) [BLM15BD152SN1D](#)
[BLM15BD152SZ1D](#) [BLE18PS080SZ1D](#) [BLM21PG221BH1D](#) [WLBD1005HCU330TL](#) [BLM21AG471BH1D](#) [BLE18PS080BH1D](#)
[BLM21AG331BH1D](#) [BLM21PG300BH1D](#) [BLM21PG600BH1D](#) [BLM03HB401SZ1D](#) [BLM03HB401SN1D](#)