

Chip beads

For general signal line

MMZ series (for automotive)



AEC-Q200

MMZ0603 type



FEATURES

- Noise reduction solution for general signal line.
- Various frequency characteristics with 4 materials of different features for countermeasures against everything from general signals to high-speed signals.
- Operating temperature range: -55 to +125°C
- Compliant with AEC-Q200

APPLICATION

- Various ECUs, powertrains, body controls, and car multimedia (telematics).

PART NUMBER CONSTRUCTION

MMZ	0603	S	100	C	T	D25
Series name	LxWxT dimensions 0.6x0.3x0.3 mm	Material name	Impedance (Ω) at 100MHz	Characteristic type	Packaging style	Internal code

CHARACTERISTICS SPECIFICATION TABLE

Impedance [100MHz] (Ω)	Tolerance	DC resistance (Ω)max.	Rated current (mA)max.	Part No.
10	$\pm 5\Omega$	0.05	1000	MMZ0603S100CTD25
80	$\pm 25\%$	0.30	200	MMZ0603S800CTD25
120	$\pm 25\%$	0.45	200	MMZ0603S121CTD25
240	$\pm 25\%$	0.57	200	MMZ0603S241CTD25
470	$\pm 25\%$	1.30	100	MMZ0603S471CTD25
600	$\pm 25\%$	1.45	100	MMZ0603S601CTD25
75	$\pm 25\%$	0.35	300	MMZ0603Y750CTD25
120	$\pm 25\%$	0.39	200	MMZ0603Y121CTD25
240	$\pm 25\%$	0.80	200	MMZ0603Y241CTD25
470	$\pm 25\%$	1.40	200	MMZ0603Y471CTD25
600	$\pm 25\%$	1.50	200	MMZ0603Y601CTD25
33	$\pm 25\%$	0.70	200	MMZ0603D330CTD25
47	$\pm 25\%$	0.70	200	MMZ0603D470CTD25
56	$\pm 25\%$	0.95	100	MMZ0603D560CTD25
80	$\pm 25\%$	1.25	100	MMZ0603D800CTD25
120	$\pm 25\%$	1.40	100	MMZ0603D121CTD25
10	$\pm 5\Omega$	0.50	200	MMZ0603F100CTD25
22	$\pm 25\%$	1.00	200	MMZ0603F220CTD25
33	$\pm 25\%$	1.30	150	MMZ0603F330CTD25

Measurement equipment

Measurement item	Product No.	Manufacturer
Impedance	E4991A+16197	Keysight Technologies
DC resistance	Type-7556	Yokogawa

* Equivalent measurement equipment may be used.

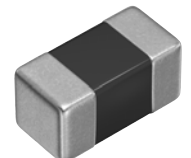

MMZ0603 type

Z VS. FREQUENCY CHARACTERISTICS (BY SERIES)

MMZ0603S-C series

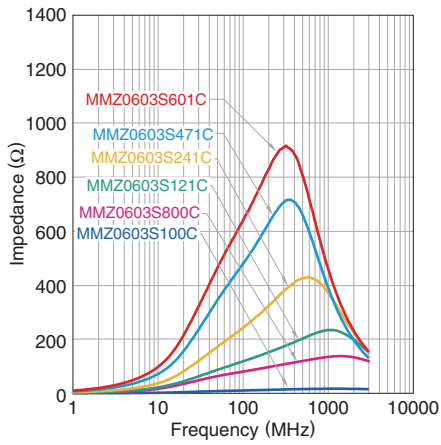

MMZ0603Y series

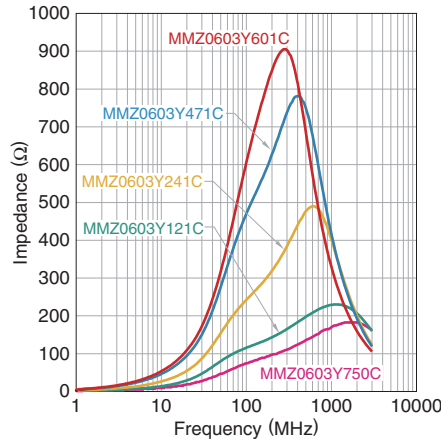

MMZ0603D series

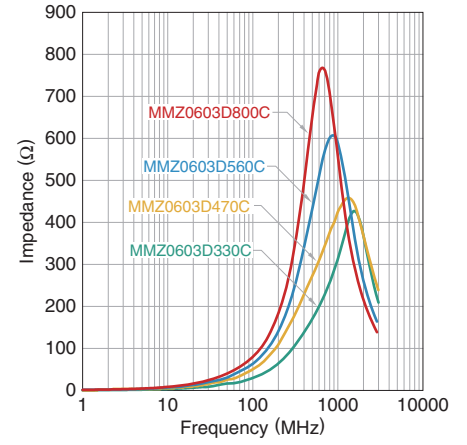

MMZ0603F series

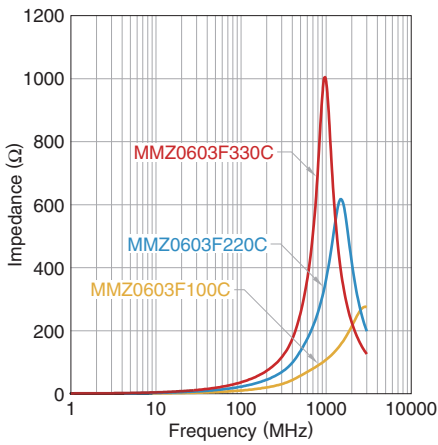

MMZ0603 type

Z, X, R VS. FREQUENCY CHARACTERISTICS

MMZ0603S100CTD25

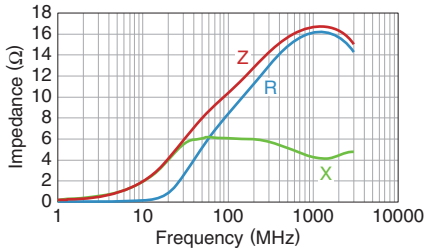

MMZ0603S800CTD25

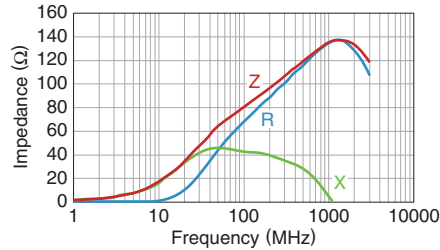

MMZ0603S121CTD25

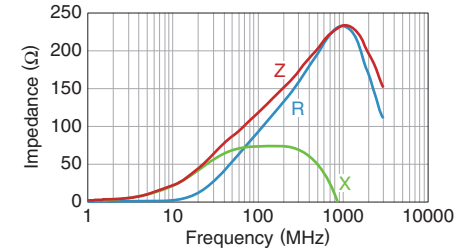

MMZ0603S241CTD25

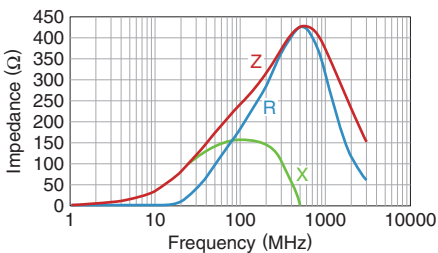

MMZ0603S471CTD25

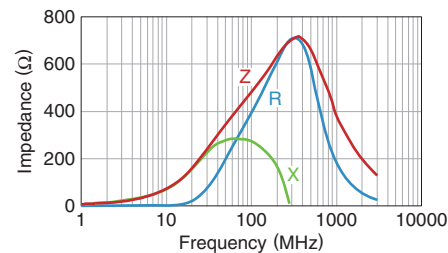

MMZ0603S601CTD25

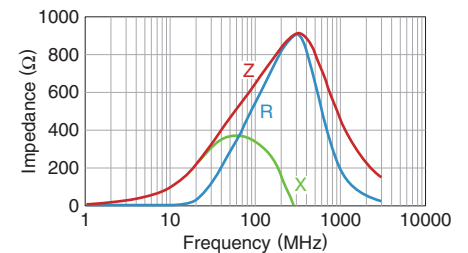

MMZ0603Y750CTD25

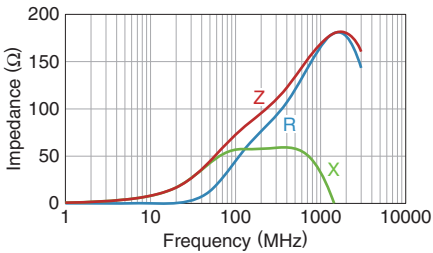

MMZ0603Y121CTD25

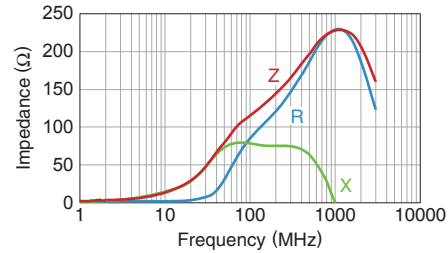

MMZ0603Y241CTD25

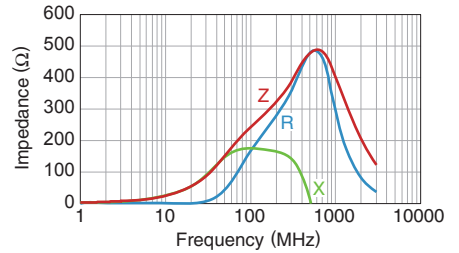

MMZ0603Y471CTD25

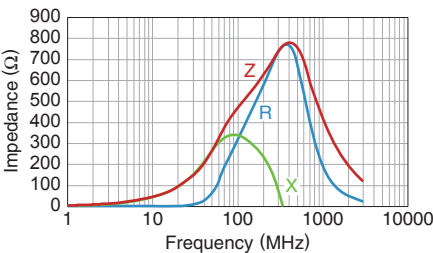

MMZ0603Y601CTD25

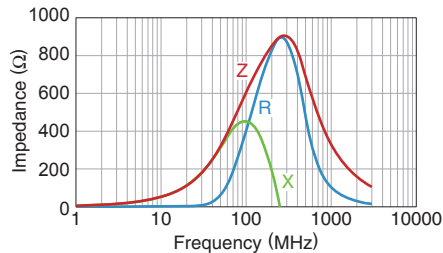

MMZ0603D330CTD25

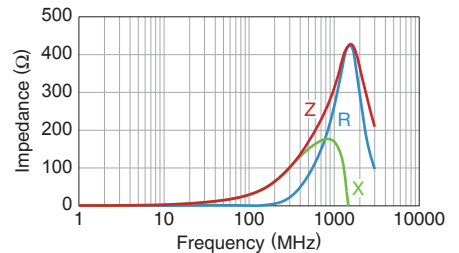

MMZ0603D470CTD25

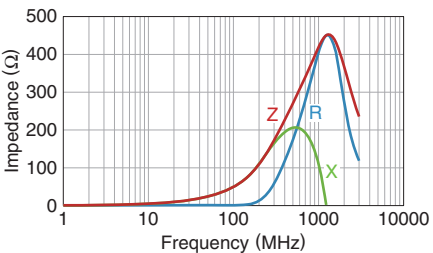

MMZ0603D560CTD25

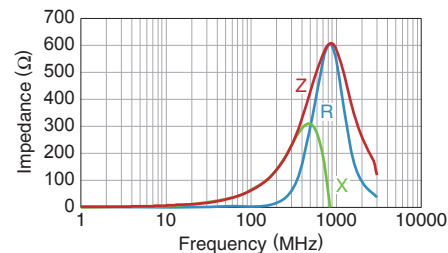

MMZ0603D800CTD25

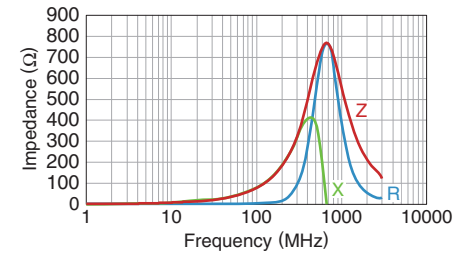

MMZ0603 type

Z, X, R VS. FREQUENCY CHARACTERISTICS

MMZ0603D121CTD25

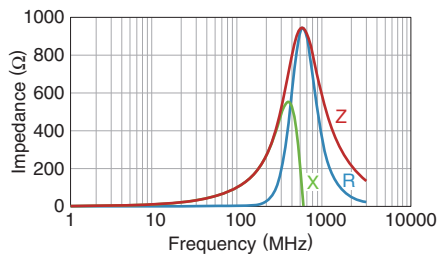

MMZ0603F100CTD25

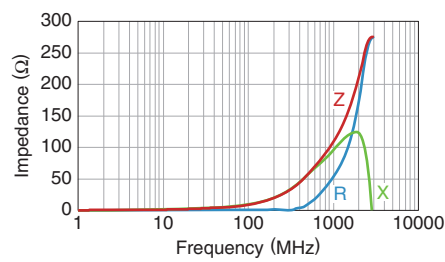

MMZ0603F220CTD25

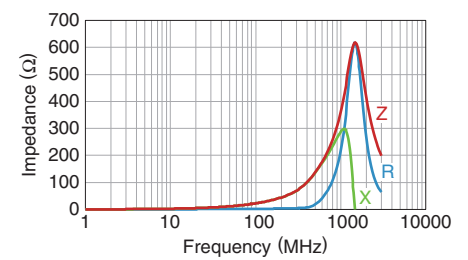

MMZ0603F330CTD25

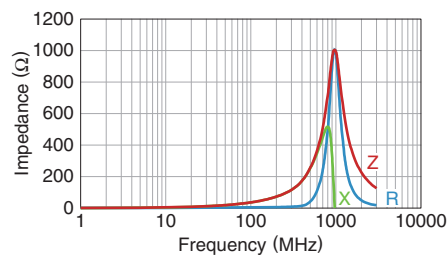

MMZ0603 type

SHAPE & DIMENSIONS

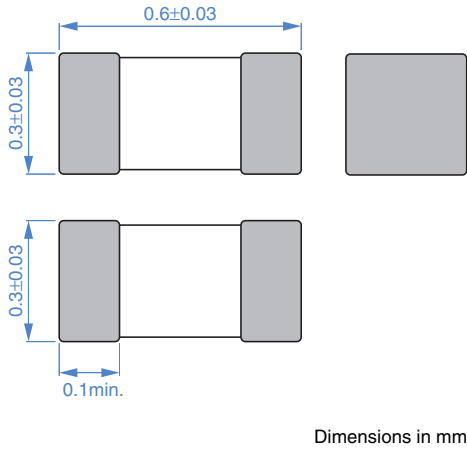

PACKAGING STYLE

REEL DIMENSIONS

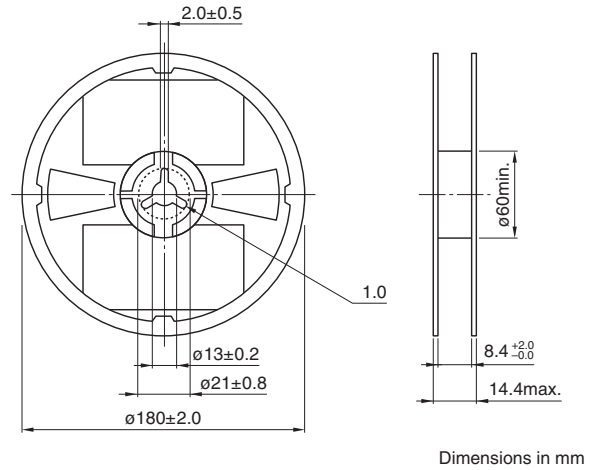

RECOMMENDED LAND PATTERN

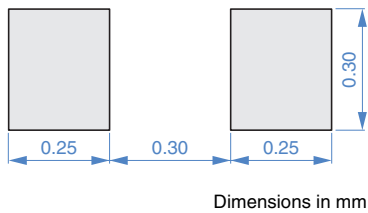

TAPE DIMENSIONS

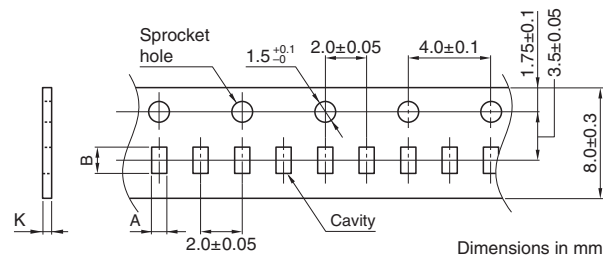

RECOMMENDED REFLOW PROFILE

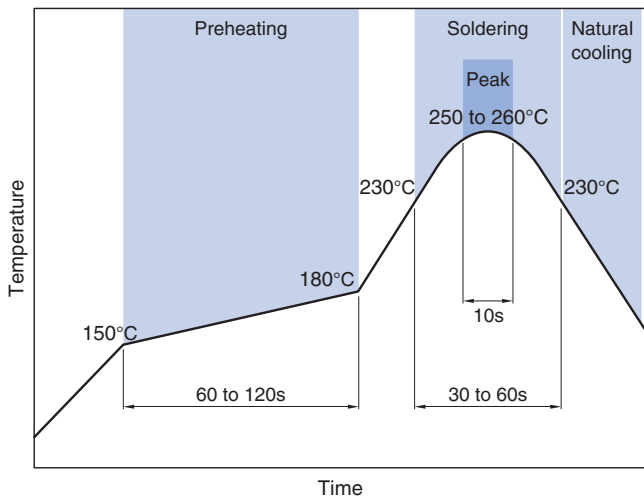

Type	A	B	K
MMZ0603	0.38±0.05	0.68±0.05	0.5max.

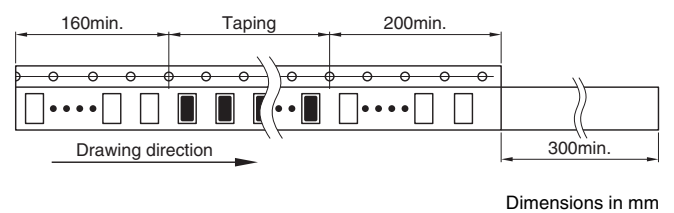

PACKAGE QUANTITY

Package quantity	15,000 pcs/reel
------------------	-----------------

TEMPERATURE RANGE, INDIVIDUAL WEIGHT

Operating temperature range	Storage temperature range*	Individual weight
-55 to +125°C	-55 to +125°C	0.3 mg

* The storage temperature range is for after the assembly.

REMINDERS FOR USING THESE PRODUCTS

Before using these products, be sure to request the delivery specifications.

SAFETY REMINDERS

Please pay sufficient attention to the warnings for safe designing when using this products.

REMINDERS

- The storage period is within 12 months. Be sure to follow the storage conditions (temperature: 5 to 40°C, humidity: 10 to 75% RH or less).
If the storage period elapses, the soldering of the terminal electrodes may deteriorate.
- Do not use or store in locations where there are conditions such as gas corrosion (salt, acid, alkali, etc.).
- Before soldering, be sure to preheat components.
The preheating temperature should be set so that the temperature difference between the solder temperature and chip temperature does not exceed 150°C.
- Soldering corrections after mounting should be within the range of the conditions determined in the specifications.
If overheated, a short circuit, performance deterioration, or lifespan shortening may occur.
- When embedding a printed circuit board where a chip is mounted to a set, be sure that residual stress is not given to the chip due to the overall distortion of the printed circuit board and partial distortion such as at screw tightening portions.
- Self heating (temperature increase) occurs when the power is turned ON, so the tolerance should be sufficient for the set thermal design.
- Carefully lay out the coil for the circuit board design of the non-magnetic shield type.
A malfunction may occur due to magnetic interference.
- Use a wrist band to discharge static electricity in your body through the grounding wire.
- Do not expose the products to magnets or magnetic fields.
- Do not use for a purpose outside of the contents regulated in the delivery specifications.
- The products listed on this catalog are intended for use in general electronic equipment (AV equipment, telecommunications equipment, home appliances, amusement equipment, computer equipment, personal equipment, office equipment, measurement equipment, industrial robots) under a normal operation and use condition.
The products are not designed or warranted to meet the requirements of the applications listed below, whose performance and/or quality require a more stringent level of safety or reliability, or whose failure, malfunction or trouble could cause serious damage to society, person or property.
If you intend to use the products in the applications listed below or if you have special requirements exceeding the range or conditions set forth in the each catalog, please contact us.

- (1) Aerospace/aviation equipment
- (2) Transportation equipment (cars, electric trains, ships, etc.)
- (3) Medical equipment
- (4) Power-generation control equipment
- (5) Atomic energy-related equipment
- (6) Seabed equipment
- (7) Transportation control equipment

- (8) Public information-processing equipment
- (9) Military equipment
- (10) Electric heating apparatus, burning equipment
- (11) Disaster prevention/crime prevention equipment
- (12) Safety equipment
- (13) Other applications that are not considered general-purpose applications

When designing your equipment even for general-purpose applications, you are kindly requested to take into consideration securing protection circuit/device or providing backup circuits in your equipment.

X-ON Electronics

Largest Supplier of Electrical and Electronic Components

Click to view similar products for [Ferrite Beads](#) category:

Click to view products by [TDK](#) manufacturer:

Other Similar products are found below :

[CZB1JGTTD152P](#) [CZB2AFTTD800P](#) [CZB2AGTTD121P](#) [PE-0402FB121ST](#) [AB 3X2X3SM](#) [DER0705-2.2](#) [NCB0603R301TR050F](#)
[NCB0805A320TR050F](#) [NCB-H1206B680TR300F](#) [CZB1JGTTD221P](#) [CZB1JGTTD600P](#) [CZB2AGTTD301P](#) [CZB2BFTTE301P](#)
[CZB2BFTTE601P](#) [4221R-1](#) [EMI0805R-600](#) [SBY100505T-100Y-N](#) [NCB-GH0402D121TR060F](#) [NCB0402P301TR005F](#)
[NCB0603R152TR030F](#) [NCB0805A121TR050F](#) [NCB0805A301TR070F](#) [NCB3312K900TR500F](#) [NCB-H0805A221TR300F](#)
[NCB0402P221TR030F](#) [NCB0805A102TR040F](#) [NCB1806E151TR020F](#) [NCB-H0402P100TR200F](#) [NCB-H0603R121TR300F](#) [NCB-](#)
[H0805A220TR600F](#) [NCB-H1206B601TR200F](#) [CZB1JGTTD202P](#) [CBH160808W221T](#) [WLBD1005HCU330TL](#) [WLBD2012HCU121TH](#)
[WLBD2012HCU221TH](#) [WQBD1608HCU121TH](#) [WLBD1608K2U252TB](#) [VLU0810-102KBC12](#) [WLBD1608K2U800TP](#) [BMB2A0080AN4](#)
[SZ1608F470TF](#) [FBSHC0805-331-302R](#) [HFJ100505T-601Y-N](#) [HFY100505T-221Y-N](#) [PBY201209T-110Y-N](#) [SBY060303T-121Y-N](#)
[BBPY00160808301Y00](#) [SBY100505T-750Y-N](#) [BBPY00100505102Y00](#)