

SPECIFICATION

TENTATIVE

SPEC. No. : U261NAA01131

DATE : November 2, 2015

To

Xiaomi

CUSTOMER'S PRODUCT NAME	TDK'S PRODUCT NAME
	MPZ1608TX series

RECEIPT CONFIRMATION

DATE: YEAR MONTH DAY

TDK Corporation

Sales

Electronic Components
Sales & Marketing Group

Engineering

Electronic Components Business Company
Magnetics Business Group
Multilayer Products Business Unit

APPROVED	PERSON IN CHARGE

APPROVED	CHECKED	PERSON IN CHARGE
Y.Abe	M.Shimoyasu	Y.Aoki

CAUTION WHEN HANDLING

Before use the products, please read this specification.

CAUTION FOR SAFETY USING

When use the products, be careful to the mentioned below for safety using.



CAUTION

- * Do not use and store the product in condition of gas corrosion (Salt, Acid, Alkaline).
- * The product must be preheated before soldering. Difference between preheat and soldering temperature must be within 150°C.
- * Rework by soldering iron ; Please keep the mentioned conditions in this specification.
- * When the product is coated with resin, please verify the quality influence on the product.
- * Please verify carefully that there is no harmful decomposing or reaction gas emission from resin during curing process or under natural condition, which may generate an adverse impact on the product.
- * In case of insert P.C. Board on chassis, do not add mechanical stress to the product.
- * The product has self heat (temperature rise) by current, so keep margin for heat design.
- * Please pay attention to arrangement of non-magnetic type inductors in board design. Errors may be caused by magnetic field coupling.
- * To handle the products, please use wrist strap for ground static discharge on human body.
- * Please keep the product away from magnet or magnetized things.
- * Do not use the product beyond the mentioned conditions in this specification.
- * About an application

The products listed on this specification sheet are intended for use in general electronic equipment (AV equipment, telecommunications equipment, home appliances, amusement equipment, computer equipment, personal equipment, office equipment, measurement equipment, industrial robots) under a normal operation and use condition. The products are not designed or warranted to meet the requirements of the applications listed below, whose performance and/or quality require a more stringent level of safety or reliability, or whose failure, malfunction or trouble could cause serious damage to society, person or property. Please understand that we are not responsible for any damage or liability caused by use of the products in any of the applications below or for any other use exceeding the range or conditions set forth in this specification sheet.

- 1) Aerospace/Aviation equipment
- 2) Medical equipment which directly endanger human life
- 3) Power-generation control equipment
- 4) Atomic energy-related equipment
- 5) Seabed equipment
- 6) Transportation control equipment
- 7) Military equipment
- 8) Safety equipment
- 9) Other applications that are not considered general-purpose applications

If you intend to use the products in the following applications, please contact our sales office.

- + Transportation equipment (cars, electric trains, ships, etc.),
- + Public information-processing equipment,
- + Electric heating apparatus / burning equipment,
- + Disaster prevention/crime prevention equipment

When using this product in general-purpose applications, you are kindly requested to take into consideration securing protection circuit/equipment or providing backup circuits, etc., to ensure higher safety.

REVISION RECORD

SYM	DATE	SIGN	REVISION RECORD

TABLE OF CONTENTS

	Page
CAUTION	1
REVISION RECORD	2
TABLE OF CONTENTS	2
1.0 SCOPE	3
2.0 PRODUCT IDENTIFICATION	3
3.0 OUTLINE DRAWING AND DIMENSIONS.....	3
3.1 Dimensions	3
3.2 Materials	3
4.0 CHARACTERISTICS	4 to 5
4.1 Test Method.....	4
4.2 Electrical Characteristics	5
5.0 RELIABILITY TEST	6 to 7
6.0 TAPING SPECIFICATION	8 to 9
6.1 Reel dimensions and label	8
6.2 Tape dimensions and material	8
6.3 Shape of packing	9
6.4 Peel back force	9
6.5 Packing form and indication contents	9
6.6 Storage conditions	9
7.0 OTHERS	10
7.1 Recommended solder condition	10
7.2 Pb Free	10
7.3 RoHS	10
7.4 Halogen-free	10
7.5 MSL	10
7.6 Appearance	10

1. SCOPE

This specification applies to the chip beads (MPZ1608TX type) delivered to Xiaomi.

2. PRODUCT IDENTIFICATION

MPZ 1608 S TX 102 A T ***
 (1) (2) (3) (4) (5) (6) (7) (8)

- (1) Chip Power Beads
- (2) Dimensions (1.6mm x 0.8mm)
- (3) Material name
- (4) T Dimensions (TX : 0.85 mm MAX)
- (5) Impedance (102 : 1000 ohm)
- (6) Characteristic type
- (7) Package type (T : Taping)
- (8) Control number

3. OUTLINE DRAWING AND DIMENSIONS

3.1 Dimensions

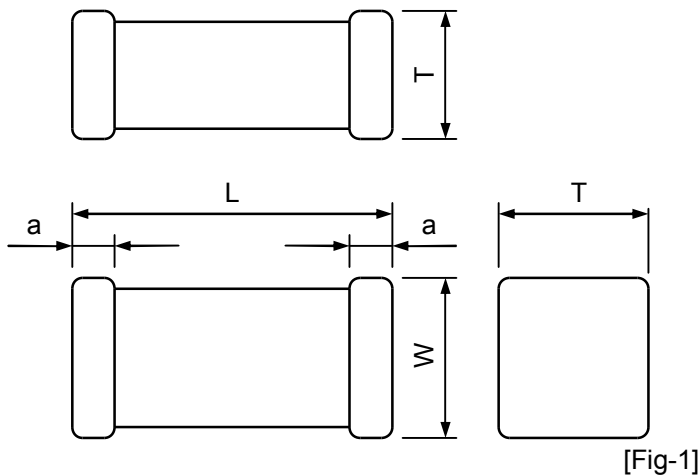

[Table-1]

Dimensions				Weight [mg]
L [mm]	W [mm]	T [mm]	a [mm]	
1.60 ± 0.15	0.75 ± 0.10	0.75 ± 0.10	0.30 ± 0.20	4.0 (Ref)

3.2 Materials

1	Ferrite (Fe-Ni-Cu-Zn Ferrite)
2	Internal Electrode (Ag)
3	Terminal Electrode (Ag)
4	Electro Plating (Cu-Ni-Sn)

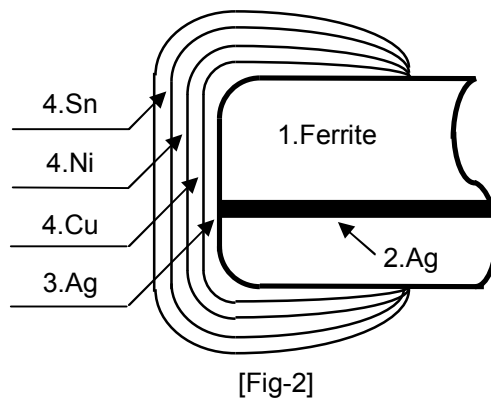

4. CHARACTERISTICS

Unless otherwise specified, the standard measurement conditions is as follow ;

Ambient temperature : 5C to 35C
Relative humidity : 35 % to 85 %
Air pressure : 86kPa to 106kPa

If there is any doubt about the results, measurements shall be made within the following conditions;

Ambient temperature : 20 ± 2C
Relative humidity : 60 % to 70 %
Air pressure : 86kPa to 106kPa

Operating temperature range : -55C to 125C

Storage temperature range : -55C to 125C (After mount)

Humidity range : 0 to 90%RH
(The least upper wet-bulb temperature is 38C)

4.1 TEST METHOD

4.1.1 Impedance

[1] Test equipment and test fixture

Test equipment : Impedance Analyzer 4291 or same type

Test fixture : 16192A or same type

[2] Test method

Set the measurement conditions , and put a specimen in test fixture ,
then read the impedance value.

4.1.2 Direct-Current of Resistance (RDC)

[1] Test equipment

Test equipment : Multi-meter 755611 or same type

[2] Test method

Set the measurement conditions , and put a specimen in test fixture ,
then read the RDC value.

4.2 ELECTRICAL CHARACTERISTICS

[Table-2]

*Operating Temperature : -55C to 125C

Customer's Product Name	TDK's Product Name	IMPEDANCE @100MHz [ohm]	DC Resistance [ohm] MAX.	*Rated Current [A] MAX.
	MPZ1608STX102AT***	1000 ± 25%	0.300	0.8

*Please refer to the graph of RATED CURRENT vs. TEMPERATURE CHARACTERISTICS (DERATING) about the rating current at 85C or more in temperature of the product.

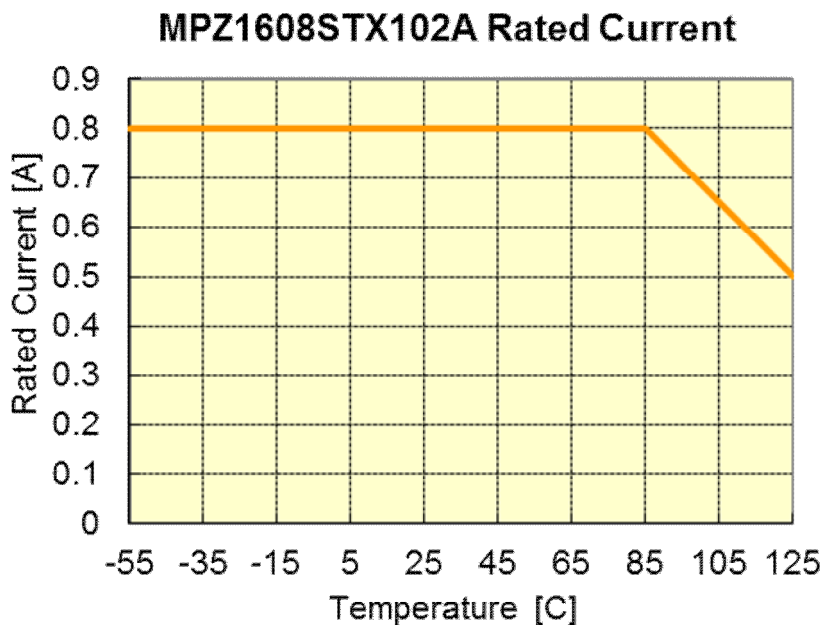

5. RELIABILITY TEST

[Table-3]

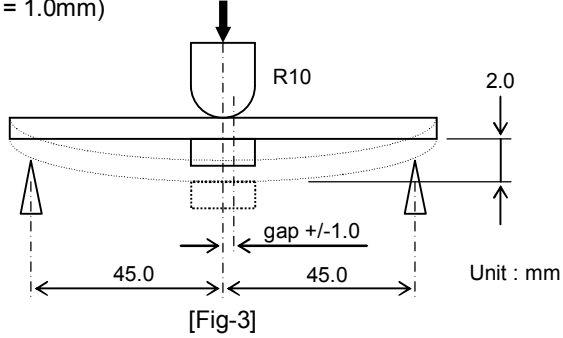
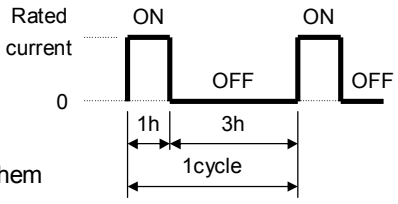
	Item	Conditions	Specifications
1	Bending test	<p>Solder specimen beads on the test printed circuit board. Apply the load in direction of the arrow until the bending reaches 2.0mm. (PCB thickness = 1.0mm)</p>  <p>[Fig-3]</p>	Appearance : No mechanical damage.
2	Vibration test	<p>Apply vibrations in each of the x, y and z directions for 2 hours (total of 6 hours). Frequency : 10 ~ 500 ~ 10Hz Total amplitude : 1.5mm</p>	Impedance Variation to be within ±20% Appearance : No mechanical damage.
3	Drop test	Drop soldered specimen beads 10 times from a height of 1 meter.	Impedance Variation to be within ±20% Appearance : No mechanical damage.
4	* Humidity with load test	<p>Leave specimen beads at 60±2C and 90 to 95%RH within the rated current for 500±12 hours.</p> <p>[Current condition] Load the rated current for 1hour(ON) / 3hours(OFF).</p> <p>Measure the test items after leaving them in normal temperature and humidity for 1 to 2 hours.</p>  <p>[Fig-4]</p>	Impedance Variation to be within ±30% Appearance : No mechanical damage..
5	* High Temperature with load test	<p>Leave specimen beads at 85±2C within the rated current for 500±12 hours. Measure the test items after leaving them in normal temperature and humidity for 1 to 2 hours.</p>	Impedance Variation to be within ±30% Appearance : No mechanical damage.
6	Cold test	<p>Leave specimen beads at -55C for 500±12 hours. Measure the test items after leaving them in normal temperature and humidity for 1 to 2 hours.</p>	Impedance Variation to be within ±20% Appearance : No mechanical damage.

* Note : Solder within 5specimen beads at intervals on the reliability test board.

[Table-3] Continue

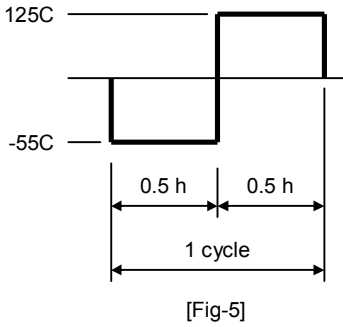
	Item	Conditions	Specifications
7	Heat shock test	<p>Go through 500 cycles under the following conditions. Measure the test items after leaving them in normal temperature and humidity for 1 to 2 hours.</p>  <p style="text-align: center;">[Fig-5]</p>	<p>Impedance Variation to be within $\pm 30\%$ Appearance : No mechanical damage.</p>
8	Resistance to soldering heat test	<p>After flux application and preheat for 1 to 2 minutes at 150C to 180C, then dip in solder at 260 ± 5C for 10.0 ± 0.5 seconds. Flux : Rosin (JIS-K-5902) dissolved in Isopropyl Alcohol (JIS-K-8839) at the weight rate of 25% Solder : Sn - 3Ag - 0.5Cu</p>	<p>Terminal electrodes should remain over than 90% Appearance : No mechanical damage.</p>
9	Solderability test	<p>After flux application and preheat for 1 to 2 minutes at 150C to 180C, then dip in solder at 250 - 260C for 4.0 ± 0.5 seconds. Flux : Rosin (JIS-K-5902) dissolved in Isopropyl Alcohol (JIS-K-8839) at the weight rate of 25% Solder : Sn - 3Ag - 0.5Cu</p>	<p>The terminal electrodes should be covered by new solder over than 90%</p>

6. TAPING SPECIFICATION

6.1 Reel dimensions and label

[Table-4]

A	$\phi 180.0 \pm 2.0$
B	$\phi 60.0$ Min.
C	$\phi 13.0 \pm 0.2$
D	$\phi 21.0 \pm 0.8$
E	2.0 ± 0.5
W1	$8.4 + 2.0 / 0$
W2	14.4 Max.
R	1.0

(Unit : mm)

Reel material : Polystyrene

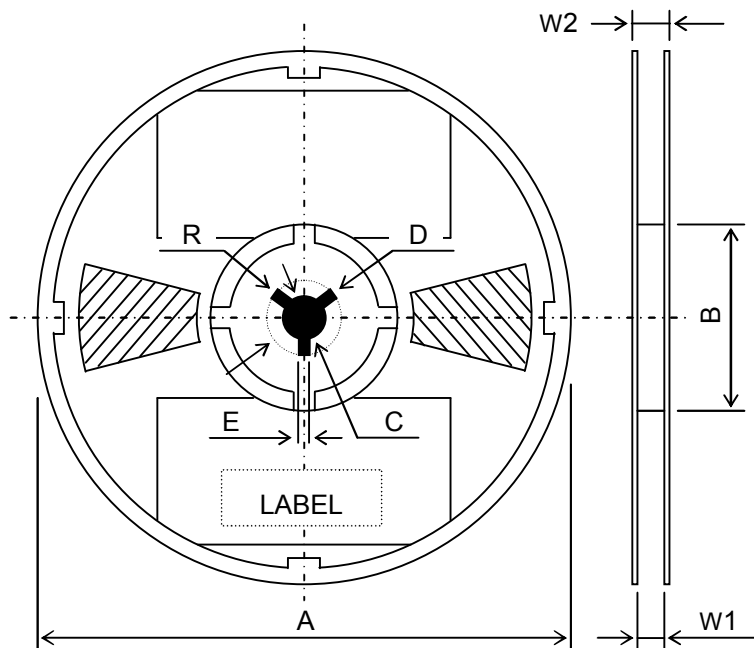

[Fig-6]

6.2 Tape dimensions and material

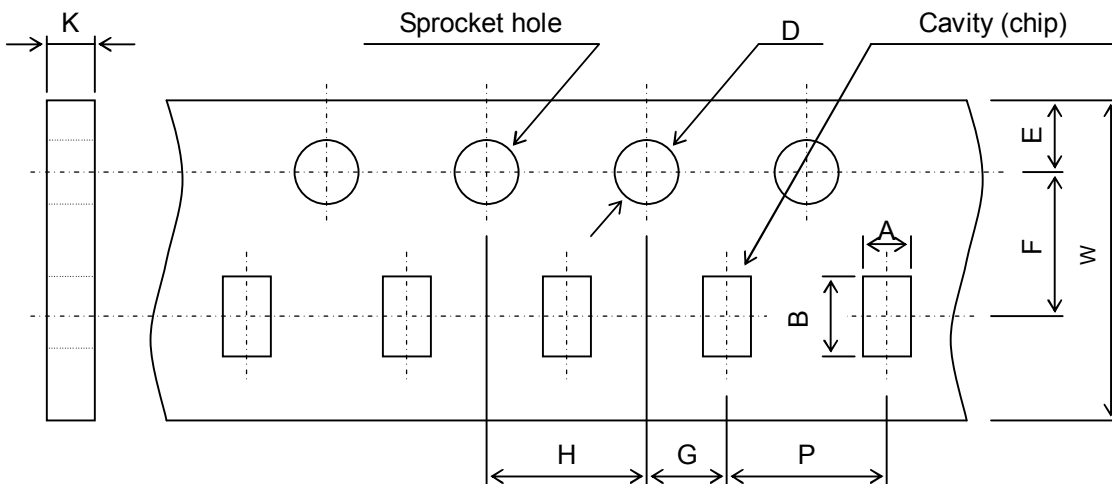

[Fig-7]

[Table-5]

A	B	D	E	F	G	H	K
1.10 ± 0.20	1.90 ± 0.20	$1.50 + 0.10 / 0$	1.75 ± 0.10	3.50 ± 0.05	2.00 ± 0.05	4.00 ± 0.10	1.10 MAX.
P	W	(Unit : mm)					
4.00 ± 0.10	8.00 ± 0.30						

Carrier Tape material : Paper
Cover Tape material : Polyester

6.3 Shape of Packing

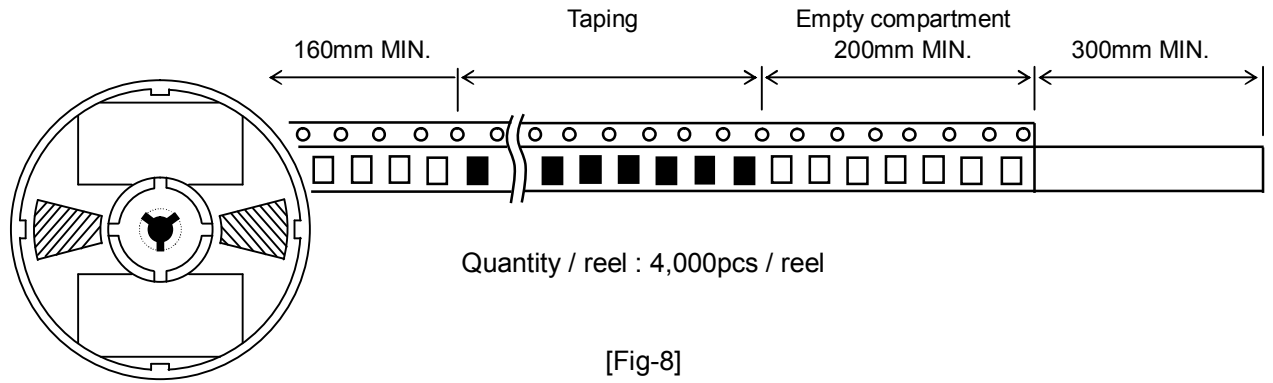

6.4 Peel back force

Peel back force is 0.1N to 1.0N in accordance with JIS C 0806.

6.5 Packing form and indication contents

(For example)

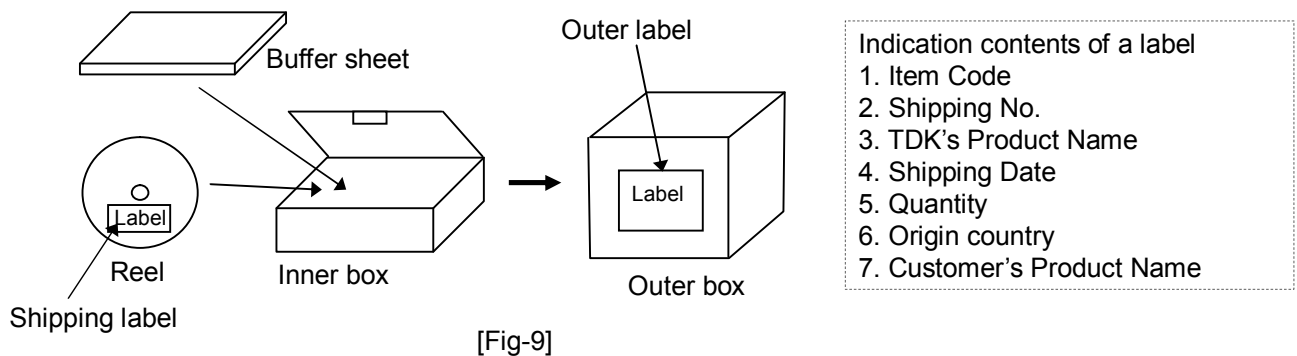

*) In case of Japanese domestic shipping , Outer label is put on the Inner box.
Because Outer box isn't used.

6.6 Storage conditions

After delivered, use the products within 12 months under the conditions 5 to 40°C and 10 to 75%RH.
Solderability should be confirmed in case of exceeding 12 months.

7. OTHERS

7.1 Recommended solder condition

7.1.1 Reflow soldering (for Lead free Solder)

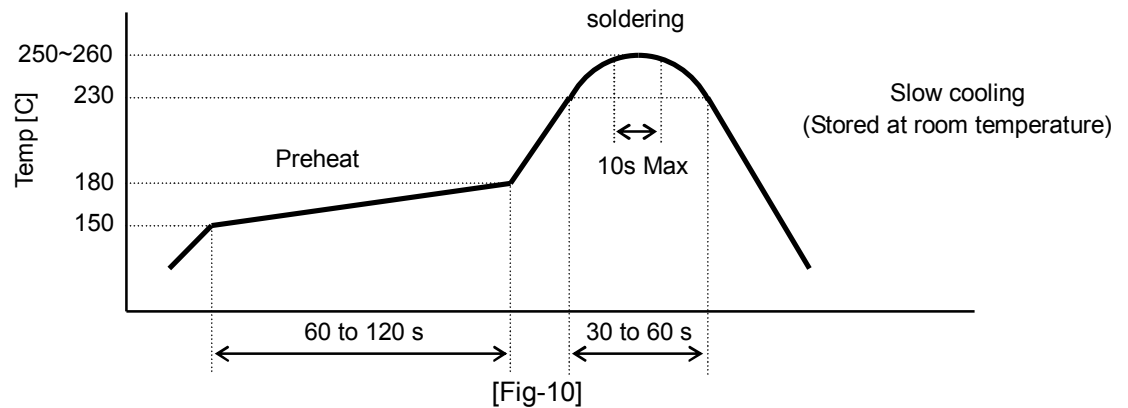

Reflow possibility times : within 2 times

7.1.2 Rework by soldering iron.

Not to contact a solder iron with the product directly.

Rework by soldering iron is less than 350°C, within 3 sec.

7.1.3 Recommended PC board Pattern

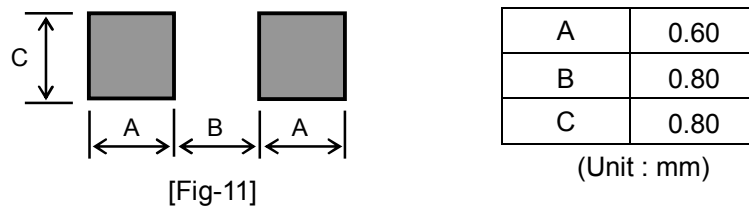

7.1.4 Cleaning

Cleaning agent : Isopropyl alcohol or equivalent

Condition : Ultrasonic cleaning

[In the normal temperature 20W/l max., 28kHz~40kHz, within 5 minutes]

7.2 This product contains no lead and also support lead-free soldering.

7.3 This product corresponds to RoHS.

It contains neither Cd, Pb, Hg, Cr6+, PBB nor PBDE.

7.4 Halogen-free

This product corresponds to Halogen-free as below.

Cl content is less than 900ppm

Br content is less than 900ppm

Total Cl and Br content is less than 1,500ppm

7.5 MSL

MSL is in accordance with Level-1

7.6 Appearance

(1)Applied standard/Sampling inspection

JIS Z 9015

Single normal sampling / LV-II

(2)Shipment standard

Major defect (*1) : AQL 0.1

Minor defect (*2) : AQL 0.4

*1:Its appearance condition makes an effect on electrical characteristics that we assure

*2:Its appearance condition does not make an effect on electrical characteristics that we assure.

X-ON Electronics

Largest Supplier of Electrical and Electronic Components

Click to view similar products for [Ferrite Beads](#) category:

Click to view products by [TDK](#) manufacturer:

Other Similar products are found below :

[2943778301](#) [BMB1J0120BN3JIT](#) [82350120560](#) [0261014605](#) [2643066902](#) [3061000011](#) [2673045901](#) [2643083601](#) [2643074901](#) [4361142521](#)
[4078078621](#) [4078044821](#) [4078033621](#) [CZB2BFTTE121P](#) [BMB2A0120AN2](#) [BMB1J0200BN3JIT](#) [EMI0805R-220](#) [74279250](#) [7427924](#)
[CZB1JGTTD202P](#) [MAF0603GWY551AT000](#) [MAF1005GWZ102AT000](#) [BLM18HE152SH1D](#) [2944778302](#) [BLM02PX600SN1D](#) [SMB2.5-1](#)
[EMI1206R-600](#) [BLM02KX180SN1D](#) [BLM02BC100SN1D](#) [BLM02KX100SN1D](#) [BLM02BB101SN1D](#) [BLM02BC220SN1D](#)
[BLE32PN260SH1L](#) [BLE32PN260SN1L](#) [BLE32PN260SZ1L](#) [74275013](#) [7427503](#) [BLM18HE601SH1D](#) [BLM15BD152SN1D](#)
[BLM15BD152SZ1D](#) [BLE18PS080SZ1D](#) [BLM21PG221BH1D](#) [WLBD1005HCU330TL](#) [BLM21AG471BH1D](#) [BLE18PS080BH1D](#)
[BLM21AG331BH1D](#) [BLM21PG300BH1D](#) [BLM21PG600BH1D](#) [BLM03HB401SZ1D](#) [BLM03HB401SN1D](#)