



3-TERMINAL FILTERS

Feedthrough filter for power line

YFF-P series

| | | |
|----------------|--------------------------|--|
| YFF15PC | 1005 [0402 inch]* | Feedthrough filter |
| YFF18PC | 1608 [0603 inch]* | Feedthrough filter |
| YFF18PH | 1608 [0603 inch]* | Feedthrough filter (thickness: 0.8mm) |
| YFF18PW | 1608 [0603 inch]* | Feedthrough filter (low ESL type) |
| YFF21PC | 2012 [0805 inch]* | Feedthrough filter |
| YFF31PC | 3216 [1206 inch]* | Feedthrough filter |

* Dimensions code JIS[EIA]

3-TERMINAL FILTERS

Feedthrough filter for power line

Conformity to RoHS directive
Compatible with lead-free solders

Overview of YFF-P series

FEATURES

- Small and high-performance EMC components.
- Good attenuation characteristics in a wide frequency band.
- For large current (2A to 4A) applications.

APPLICATIONS

For power lines of telecommunication terminal devices including smartphones, audio-visual equipment, and information equipment.

PART NUMBER CONSTRUCTION

| YFF | | 15 | | PC | | 0G | | 435 | | M | | T | | □□ | | 0 | | N | |
|-------------|------------------|---------|-----------------------|--------------------|---------------|-----|-------------|----------------------|-----------|------|--------|-------------------|-----------|------|-----------------------|---|--|---|--|
| Series name | L x W dimensions | | Product internal code | | Rated voltage | | Capacitance | | Tolerance | | Taping | TDK internal code | Reel size | | Internal electrode Ni | | | | |
| | Code | mm | | | Code | V | Code | pF | | | | | Code | mm | | | | | |
| | 15 | 1.0x0.5 | PC | STD | 0G | 4 | 104 | 100,000 | M | ±20% | | | 0 | ø178 | | | | | |
| | 18 | 1.6x0.8 | PH | Thickness 0.8mm | 0J | 6.3 | 105 | 1,000,000 (1.0µF) | | | | | 9 | ø330 | | | | | |
| | 21 | 2.0x1.2 | | | | | 1A | 10 | | | | | | | | | | | |
| | 31 | 3.2x1.6 | PW | Low ESL | 1C | 16 | 435 | 4,300,000 (4.3µF) | | | | | | | | | | | |
| | | | | | 1E | 25 | 226 | 22,000,000 (22µF) | | | | | | | | | | | |

PACKAGING STYLE AND SPECIFICATIONS

| Type | Package quantity (piece/reel) | | Unit weight (g) |
|---------------|-------------------------------|--------------|--------------------|
| | ø178 (mm) | ø330 (mm) | |
| YFF15PC | 10,000 | 50,000 | 0.0008 |
| YFF15PC0G435M | 10,000 | 50,000 | 0.0015 |
| YFF15PC0G755M | 10,000 | 50,000 | 0.0027 |
| YFF15PC0G106M | 10,000 | 50,000 | 0.0029 |
| YFF18PC | 4,000 | 10,000 | 0.0038 |
| YFF18PH | 4,000 | 10,000 | 0.0051 |
| YFF18PW | 4,000 | 10,000 | 0.0038 |
| YFF21PC | 4,000 | 10,000 | 0.0095 |
| YFF31PC | 2,000 | 10,000 | 0.0342 |

- RoHS Directive Compliant Product: See the following for more details. <https://product.tdk.com/info/en/environment/rohs/index.html>
- Halogen-free: Indicates that Cl content is less than 900ppm, Br content is less than 900ppm, and that the total Cl and Br content is less than 1500ppm.

 Please be sure to request delivery specifications that provide further details on the features and specifications of the products for proper and safe use.
Please note that the contents may change without any prior notice due to reasons such as upgrading.

Overview of YFF-P series

RECOMMENDED SOLDERING CONDITION

REFLOW SOLDERING

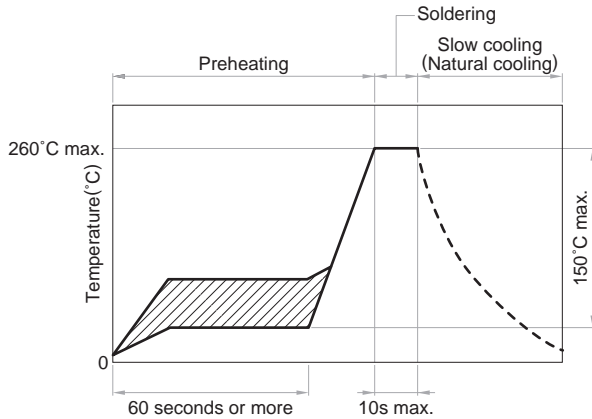

HAND SOLDERING

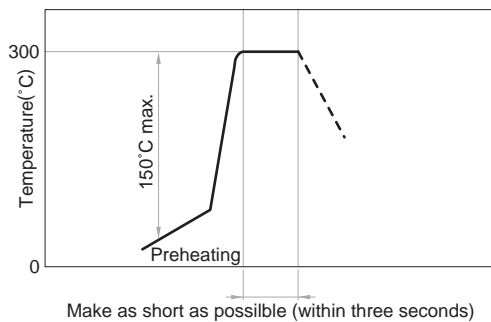

REMINDERS FOR USING THESE PRODUCTS

- Before soldering, be sure to preheat components. The ΔT preheating temperature must be 150°C max. with attention paid to thermal shock.
- Natural cooling of components in the air is recommended. On the other hand, when dipping them in a solvent for purposes, such as cleaning, make sure that the temperature difference (ΔT) is 100°C.
- When performing hand soldering for circuit modification, apply the soldering iron to the copper foil area of the printed circuit board for 3 seconds or less. The temperature of the iron tip should not exceed 300°C.
- Use a wrist band to discharge static electricity in your body through the grounding wire.
- When incorporating the printed circuit board on which this product is mounted into a frame, etc., do not apply stress to the product through local bending of the board by tightening of screws, etc.

YFF-P series YFF15PC type

SHAPE & DIMENSIONS

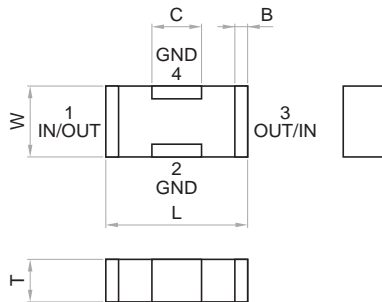

RECOMMENDED LAND PATTERN

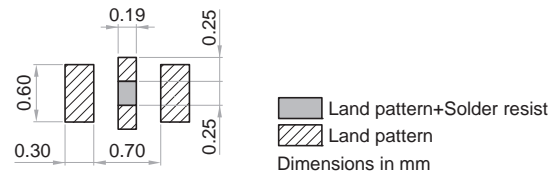

| Part No. | L (mm) | W (mm) | T (mm) | B (mm) | C (mm) |
|--------------------|-----------|-----------|-----------|----------|-----------|
| YFF15PC0G106MT00□N | 1.00±0.20 | 0.50±0.20 | 0.50±0.15 | 0.07min. | 0.35±0.10 |
| YFF15PC0G755MT00□N | 1.00±0.20 | 0.50±0.15 | 0.50±0.15 | 0.07min. | 0.35±0.10 |
| YFF15PC0G435MT00□N | 1.05±0.05 | 0.65±0.05 | 0.45±0.05 | 0.09min. | 0.30±0.10 |
| YFF15PC0G105MT00□N | 1.00±0.05 | 0.55±0.05 | 0.30±0.05 | 0.09min. | 0.30±0.10 |
| YFF15PC0J474MT00□N | 1.00±0.05 | 0.55±0.05 | 0.30±0.05 | 0.09min. | 0.30±0.10 |
| YFF15PC1A224MT00□N | 1.00±0.05 | 0.55±0.05 | 0.30±0.05 | 0.09min. | 0.30±0.10 |
| YFF15PC1C104MT00□N | 1.00±0.05 | 0.55±0.05 | 0.30±0.05 | 0.09min. | 0.30±0.10 |

* Make sure to connect the GND terminal of this product and the GND of the mounting circuit board by using through holes so that the distance between them is the shortest.

ELECTRICAL CHARACTERISTICS

CHARACTERISTICS SPECIFICATION TABLES

| Insertion loss 40dB frequency range (MHz) | Rated voltage | Rated current | Operating temperature range (°C) | Storage temperature range (After mounting) (°C) | Part No.* |
|---|------------------------|------------------------|--|--|----------------------|
| | E _{dc} (V) | I _{dc} (A) | | | |
| 0.07 to 1000 | 4 | 2 | -55 to 85 | -55 to 85 | YFF15PC0G106MT00 □ N |
| 0.11 to 1000 | 4 | 2 | -55 to 85 | -55 to 85 | YFF15PC0G755MT00 □ N |
| 0.2 to 1000 | 4 | 2 | -55 to 85 | -55 to 85 | YFF15PC0G435MT00 □ N |
| 0.8 to 1000 | 4 | 3 | -55 to 105 | -55 to 105 | YFF15PC0G105MT00 □ N |
| 2 to 1000 | 6.3 | 3 | -55 to 105 | -55 to 105 | YFF15PC0J474MT00 □ N |
| 4 to 1000 | 10 | 3 | -55 to 105 | -55 to 105 | YFF15PC1A224MT00 □ N |
| 9 to 1000 | 16 | 3 | -55 to 105 | -55 to 105 | YFF15PC1C104MT00 □ N |

* The part numbers are TDK's standard specification products.

* □: Reel size code, 0 (ø178) or 9 (ø330).

ELECTRICAL CHARACTERISTICS GRAPH

INSERTION LOSS vs. FREQUENCY CHARACTERISTICS

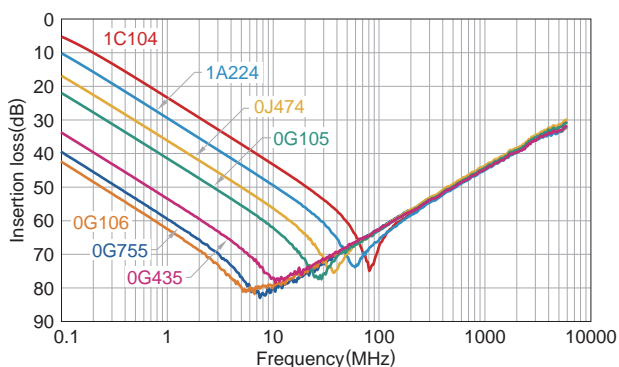

RATED CURRENT vs. TEMPERATURE CHARACTERISTICS (DERATING)

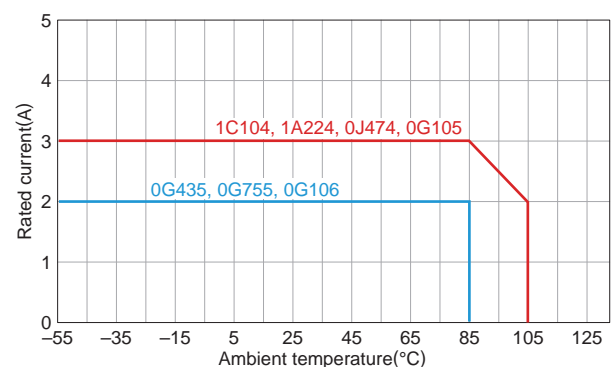

⚠ Please be sure to request delivery specifications that provide further details on the features and specifications of the products for proper and safe use.
Please note that the contents may change without any prior notice due to reasons such as upgrading.

YFF-P series YFF18PC type

SHAPE & DIMENSIONS

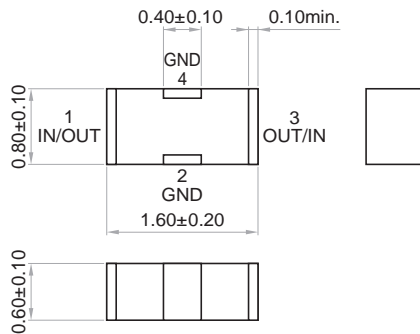

RECOMMENDED LAND PATTERN

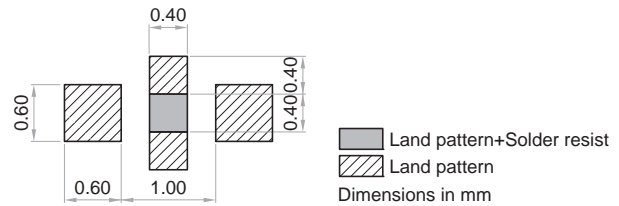

* Make sure to connect the GND terminal of this product and the GND of the mounting circuit board by using through holes so that the distance between them is the shortest.

ELECTRICAL CHARACTERISTICS

CHARACTERISTICS SPECIFICATION TABLES

| Insertion loss 40dB frequency range (MHz) | Rated voltage Edc (V) | Rated current Idc (A) | Operating temperature range (°C) | Storage temperature range (After mounting) (°C) | Part No.* |
|---|-----------------------------|-----------------------------|--|--|--------------------|
| 0.2 to 1000 | 6.3 | 4 | -55 to 85 | -55 to 85 | YFF18PC0J475MT0H□N |
| 0.8 to 1000 | 6.3 | 4 | -55 to 105 | -55 to 105 | YFF18PC0J105MT0H□N |
| 2 to 1000 | 6.3 | 4 | -55 to 125 | -55 to 125 | YFF18PC0J474MT0H□N |
| 3 to 1000 | 6.3 | 4 | -55 to 125 | -55 to 125 | YFF18PC0J224MT0H□N |
| 7 to 1000 | 16 | 4 | -55 to 125 | -55 to 125 | YFF18PC1C104MT0H□N |

* The part numbers are TDK's standard specification products.

* □: Reel size code, 0 (ø178) or 9 (ø330).

ELECTRICAL CHARACTERISTICS GRAPH

INSERTION LOSS vs. FREQUENCY CHARACTERISTICS

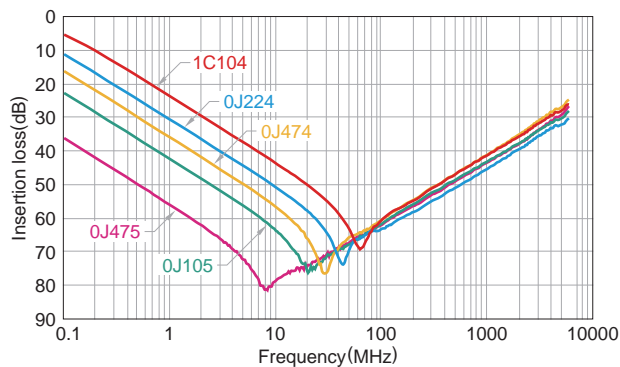

RATED CURRENT vs. TEMPERATURE CHARACTERISTICS (DERATING)

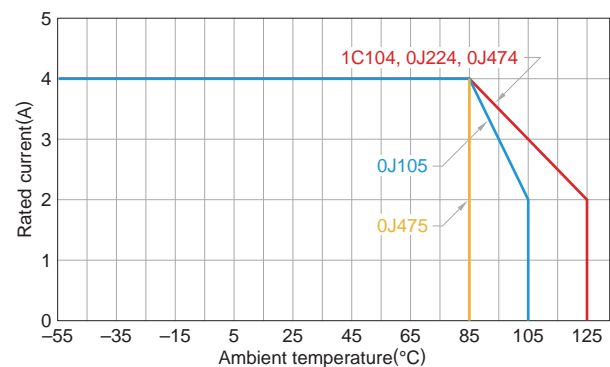

⚠ Please be sure to request delivery specifications that provide further details on the features and specifications of the products for proper and safe use.
Please note that the contents may change without any prior notice due to reasons such as upgrading.

YFF-P series YFF18PH type

SHAPE & DIMENSIONS

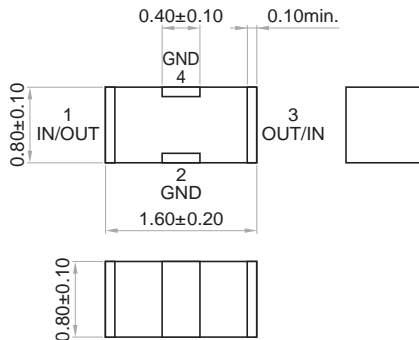

RECOMMENDED LAND PATTERN

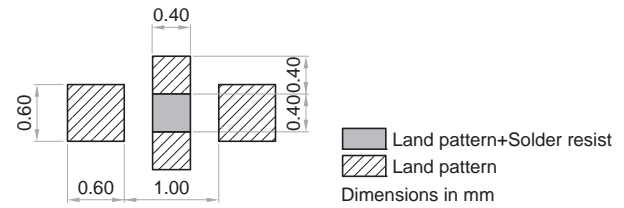

* Make sure to connect the GND terminal of this product and the GND of the mounting circuit board by using through holes so that the distance between them is the shortest.

ELECTRICAL CHARACTERISTICS

CHARACTERISTICS SPECIFICATION TABLES

| Insertion loss 40dB frequency range (MHz) | Rated voltage Edc (V) | Rated current Idc (A) | Operating temperature range (°C) | Storage temperature range (After mounting) (°C) | Part No.* |
|---|-----------------------------|-----------------------------|--|--|--------------------|
| 0.4 to 1000 | 6.3 | 4 | -55 to 85 | -55 to 85 | YFF18PH0J225MT00□N |
| 0.8 to 1000 | 6.3 | 4 | -55 to 105 | -55 to 105 | YFF18PH0J105MT00□N |

* The part numbers are TDK's standard specification products.

* □: Reel size code, 0 (ø178) or 9 (ø330).

ELECTRICAL CHARACTERISTICS GRAPH

INSERTION LOSS vs. FREQUENCY CHARACTERISTICS

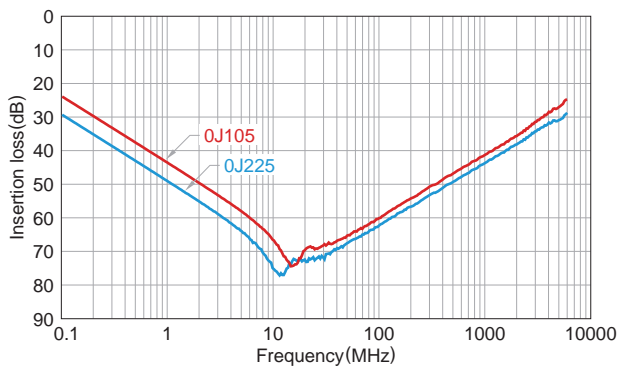

RATED CURRENT vs. TEMPERATURE CHARACTERISTICS (DERATING)

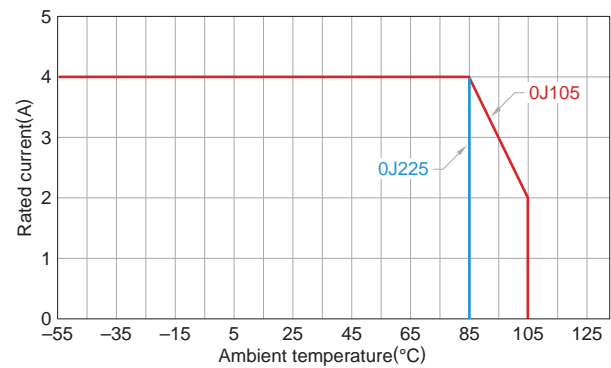

YFF-P series YFF18PW type

SHAPE & DIMENSIONS

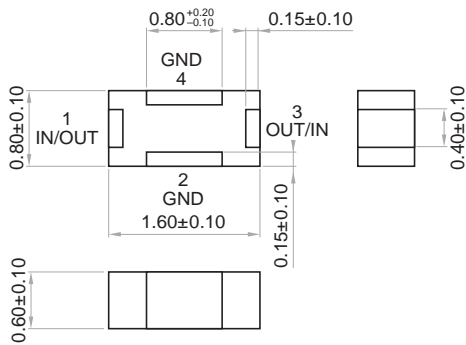

RECOMMENDED LAND PATTERN

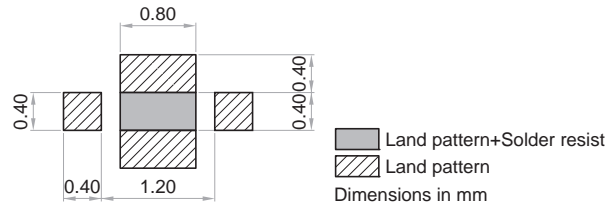

* Make sure to connect the GND terminal of this product and the GND of the mounting circuit board by using through holes so that the distance between them is the shortest.

ELECTRICAL CHARACTERISTICS

CHARACTERISTICS SPECIFICATION TABLES

| Insertion loss 40dB frequency range (MHz) | Rated voltage Edc (V) | Rated current Idc (A) | Operating temperature range (°C) | Storage temperature range (After mounting) (°C) | Part No.* |
|---|-----------------------------|-----------------------------|--|--|--------------------|
| 0.2 to 2000 | 6.3 | 4 | -55 to 85 | -55 to 85 | YFF18PW0J475MT0H□N |
| 0.8 to 2000 | 6.3 | 4 | -55 to 105 | -55 to 105 | YFF18PW0J105MT0H□N |
| 2 to 2000 | 6.3 | 4 | -55 to 125 | -55 to 125 | YFF18PW0J474MT0H□N |

* The part numbers are TDK's standard specification products.

* □: Reel size code, 0 (ø178) or 9 (ø330).

ELECTRICAL CHARACTERISTICS GRAPH

INSERTION LOSS vs. FREQUENCY CHARACTERISTICS

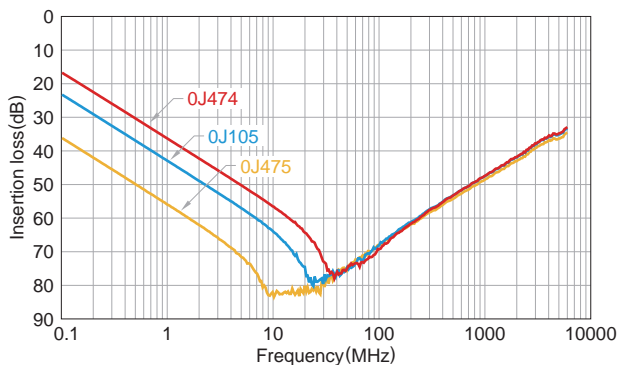

RATED CURRENT vs. TEMPERATURE CHARACTERISTICS (DERATING)

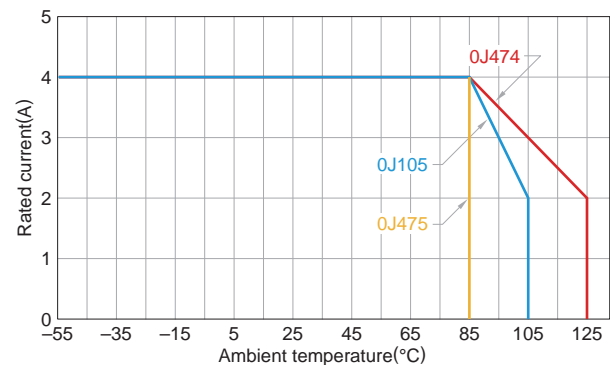

YFF-P series YFF21PC type

SHAPE & DIMENSIONS

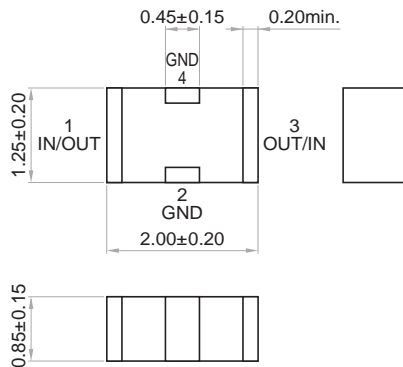

RECOMMENDED LAND PATTERN

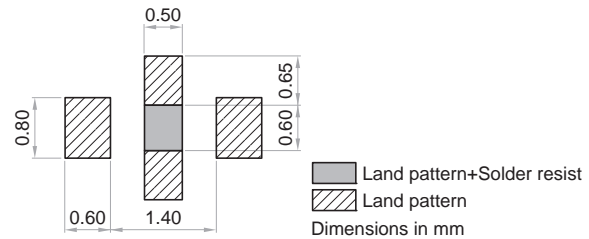

* Make sure to connect the GND terminal of this product and the GND of the mounting circuit board by using through holes so that the distance between them is the shortest.

ELECTRICAL CHARACTERISTICS

CHARACTERISTICS SPECIFICATION TABLES

| Insertion loss 40dB frequency range (MHz) | Rated voltage Edc (V) | Rated current Idc (A) | Operating temperature range (°C) | Storage temperature range (After mounting) (°C) | Part No.* |
|---|-----------------------------|-----------------------------|--|--|--------------------|
| 0.04 to 1000 | 6.3 | 4 | -55 to 85 | -55 to 85 | YFF21PC0J226MT00□N |
| 0.7 to 1000 | 10 | 4 | -55 to 85 | -55 to 85 | YFF21PC1A105MT00□N |
| 2 to 1000 | 16 | 2 | -55 to 125 | -55 to 125 | YFF21PC1C474MT00□N |
| 7 to 1000 | 25 | 2 | -55 to 125 | -55 to 125 | YFF21PC1E104MT00□N |

* The part numbers are TDK's standard specification products.

* □: Reel size code, 0 (ø178) or 9 (ø330).

ELECTRICAL CHARACTERISTICS GRAPH

INSERTION LOSS vs. FREQUENCY CHARACTERISTICS

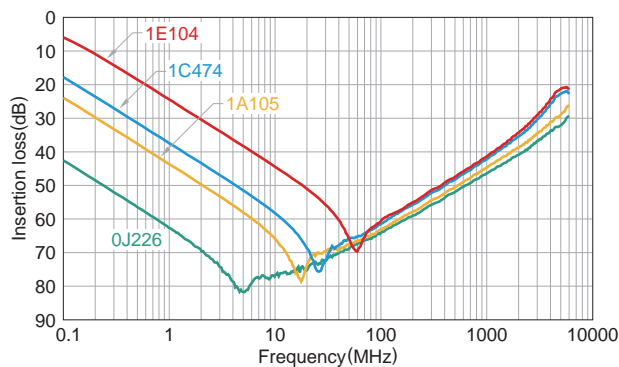

⚠ Please be sure to request delivery specifications that provide further details on the features and specifications of the products for proper and safe use.
Please note that the contents may change without any prior notice due to reasons such as upgrading.

YFF-P series YFF31PC type

SHAPE & DIMENSIONS

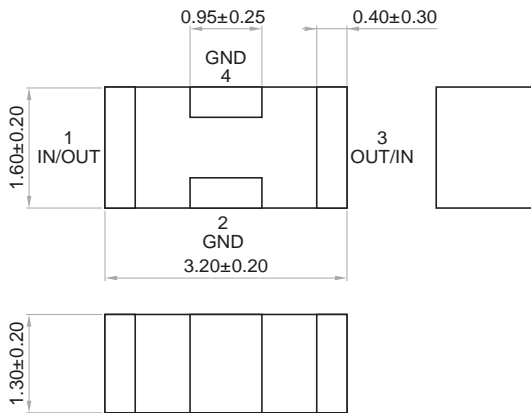

RECOMMENDED LAND PATTERN

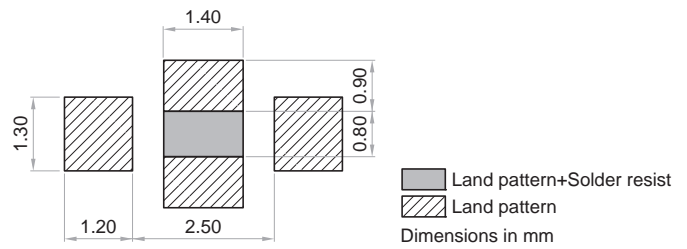

* Make sure to connect the GND terminal of this product and the GND of the mounting circuit board by using through holes so that the distance between them is the shortest.

ELECTRICAL CHARACTERISTICS

CHARACTERISTICS SPECIFICATION TABLES

| Insertion loss 40dB frequency range (MHz) | Rated voltage Edc (V) | Rated current Idc (A) | Operating temperature range (°C) | Storage temperature range (After mounting) (°C) | Part No.* |
|---|-----------------------------|-----------------------------|--|--|--------------------|
| 0.7 to 1000 | 16 | 2 | -55 to 125 | -55 to 125 | YFF31PC1C105MT00□N |
| 2 to 1000 | 16 | 2 | -55 to 125 | -55 to 125 | YFF31PC1C474MT00□N |
| 3 to 600 | 16 | 2 | -55 to 125 | -55 to 125 | YFF31PC1C224MT00□N |
| 7 to 1000 | 16 | 2 | -55 to 125 | -55 to 125 | YFF31PC1C104MT00□N |

* The part numbers are TDK's standard specification products.

* □: Reel size code, 0 (ø178) or 9 (ø330).

ELECTRICAL CHARACTERISTICS GRAPH

INSERTION LOSS vs. FREQUENCY CHARACTERISTICS

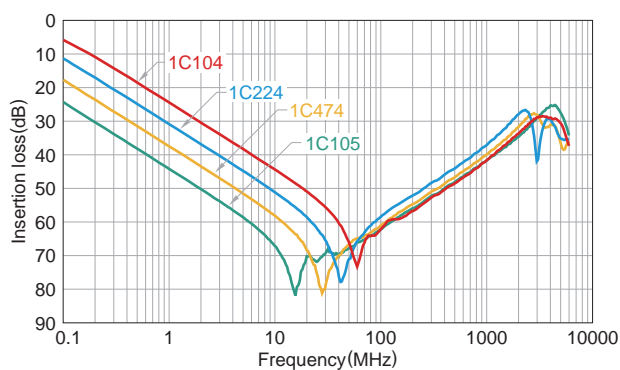

⚠ Please be sure to request delivery specifications that provide further details on the features and specifications of the products for proper and safe use.
Please note that the contents may change without any prior notice due to reasons such as upgrading.

YFF-P series

Packaging style

REEL DIMENSIONS

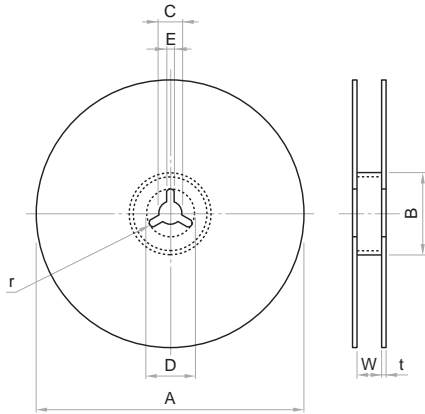

Dimensions in mm

| Reel | Dimensions in: mm | | | | | | | |
|------|----------------------|----------|---------|---------|---------|----------|----------|-----|
| | A | B | C | D | E | W | t | r |
| ø178 | ø178±2.0 | ø60±2.0 | ø13±0.5 | ø21±0.8 | 2.0±0.5 | 9.0±0.3 | 2.0±0.05 | 1.0 |
| ø330 | ø382 max.(ø330 nom.) | ø50 min. | ø13±0.5 | ø21±0.8 | 2.0±0.5 | 10.0±1.5 | 2.0±0.05 | 1.0 |

TAPE DIMENSIONS

Paper tape

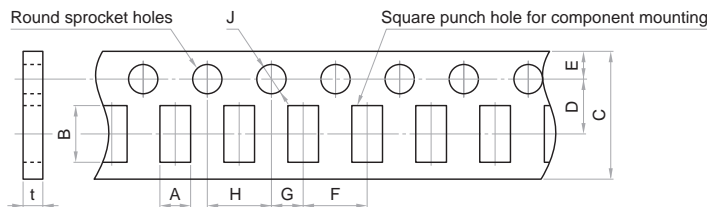

Dimensions in: mm

| Type | A | B | C | D | E | F | G | H | J | t |
|---------------|-----------|-----------|-----------|-----------|-----------|-----------|-----------|-----------|-------------|----------|
| YFF15PC | 0.62 typ. | 1.12 typ. | | | | | | | | 0.7 max. |
| YFF15PC0G435M | 0.75 typ. | 1.18 typ. | 8.00±0.30 | 3.50±0.05 | 1.75±0.10 | 2.00±0.05 | 2.00±0.05 | 4.00±0.10 | ø1.5+0.1/-0 | 0.8 max. |
| YFF15PC0G755M | 0.75 typ. | 1.30 typ. | | | | | | | | |
| YFF15PC0G106M | 0.77 typ. | 1.30 typ. | | | | | | | | |
| YFF18PC | | | | | | | | | | |
| YFF18PH | 1.10 typ. | 1.90 typ. | 8.00±0.30 | 3.50±0.05 | 1.75±0.10 | 4.00±0.10 | 2.00±0.05 | 4.00±0.10 | ø1.5+0.1/-0 | 1.2 max. |
| YFF18PW | | | | | | | | | | |
| YFF21PC | 1.50 typ. | 2.30 typ. | 8.00±0.30 | 3.50±0.05 | 1.75±0.10 | 4.00±0.10 | 2.00±0.05 | 4.00±0.10 | ø1.5+0.1/-0 | 1.2 max. |

Plastic tape

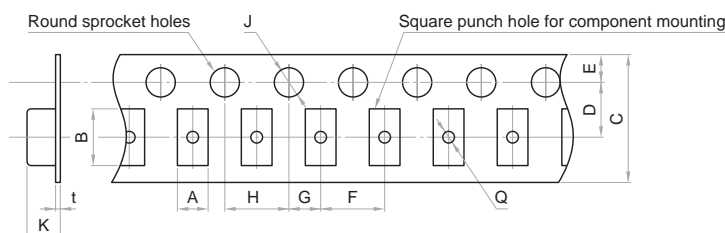

Dimensions in: mm

| Type | A | B | C | D | E | F | G | H | J | K | t | Q |
|---------|-----------|-----------|---------|----------|----------|----------|----------|----------|-------------|-----------|-----------|------------|
| YFF31PC | 1.90 typ. | 3.50 typ. | 8.0±0.3 | 3.5±0.05 | 1.75±0.1 | 4.00±0.1 | 2.0±0.05 | 4.00±0.1 | ø1.5+0.1/-0 | 2.50 max. | 0.30 max. | ø0.50 max. |

⚠ Please be sure to request delivery specifications that provide further details on the features and specifications of the products for proper and safe use.
Please note that the contents may change without any prior notice due to reasons such as upgrading.

X-ON Electronics

Largest Supplier of Electrical and Electronic Components

Click to view similar products for [Feed Through Capacitors](#) category:

Click to view products by [TDK](#) manufacturer:

Other Similar products are found below :

[4700-003MLF](#) [4700-053LF](#) [4701-001MLF](#) [4701-002MLF](#) [0805J1000101MCTE01](#) [SSM1-402E-05B](#) [SSM1-402E-10B](#) [SSM1-501P-10T1](#)
[SSM1-402E-10T1](#) [SSM1-152P-05T1](#) [4700-009MLF](#) [SSM1-101Z-05B](#) [SSM1F-402E-10T1](#) [SSM1-202P-05T1](#) [0805J0500471MATE03](#)
[PSM4-103Z-20T0](#) [0805J1000470MATE03](#) [SSM1-402Z-10T1](#) [PSM4F-402Z-20T0](#) [NFM31HK103R2A3L](#) [NFM15CC222D1C3D](#)
[NFM18PC225B1A3D](#) [NFM18PS105D0J3D](#) [NFM18CC101R1C3D/BKN](#) [CX0603MRX5R6BB224](#) [CX0603MRX7R9BB103](#)
[CX0805MRX7R0BB103](#) [CX1206MKX7R7BB224](#) [0805J0500473MXTE03](#) [0805J0500223MXTE03](#) [0805J1000102MXTE07](#)
[CX0603MRX7R0BB472](#) [PSM4-103Z-20B](#) [DSS1NB32A223Q91A](#) [DSS1NB31H104Q91A](#) [NFE61PT330B1H9L](#) [NFM21HC223R1H3D](#)
[NFM21PC225B0J3D](#) [NFM31KC104R1H3L](#) [NFM3DCC102R1H3L](#) [NFM3DCC223R1H3L](#) [NFM3DPC223R1H3L](#) [NFM41CC471R2A3L](#)
[DSS1NB32A102Q91A](#) [NFM18CC222R1C3D](#) [NFM18PS474R0J3D](#) [NFM21HC105R1C3D](#) [NFM21PC224R1C3D](#) [NFM31KC104R2A3L](#)
[NFM31KC223R1H3L](#)