

EMC Components

Common Mode Choke Coils for Signal Line SMD

ZJYS Series ZJYS51, ZJYS81 Types

FEATURES

- A common mode filter for distortion-free noise removal from transmitted signals. Optimized for transmission of high quality signals.
- Best filter for countering the common mode noise resulting from data signal processing by PCs, phone equipment, etc.
- SMD-type designed for surface mounting.
- Due to a maximum current tolerance of 5A, can also be used to counter power line noise.
- The ZJYS81R5-2PL is a high inductance common mode filter designed to use with a CAN-BUS.
- The "T" designation at the end of the product code indicates tape mounting.

APPLICATIONS

Personal computers, telephones, LANs, ISDNs, digital PBXs, electronic games, CTVs, CD-ROM drives, 8mm video equipment, and other electronic devices.

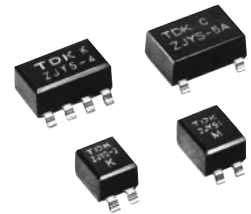

SHAPES AND DIMENSIONS/RECOMMENDED PC BOARD PATTERNS

TRANSFER MOLD

ZJYS51R5-2P(T), -2PB(T), -2PL(T), 5103-2PL(T)

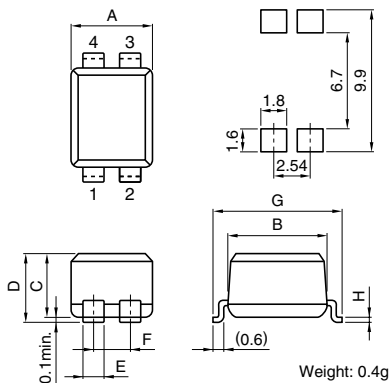

ZJYS51R5-4P(T), -M4PA(T)

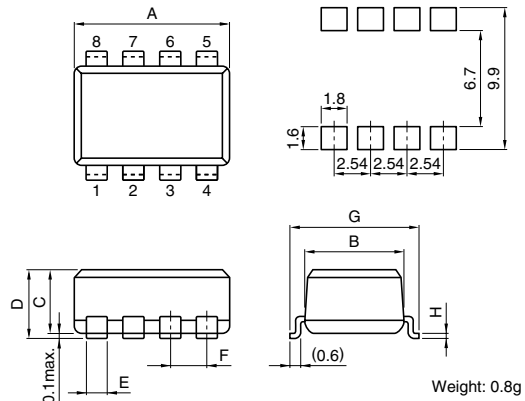

ZJYS5105-2PL(T)

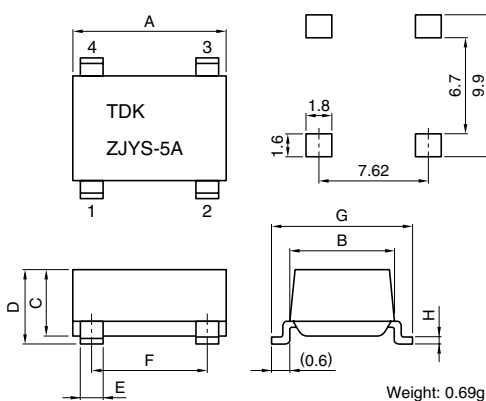

ZJYS81R5-2PL25(T)-G01, -2PL51(T)-G01

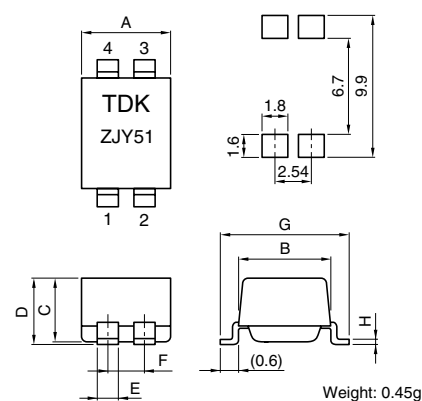

Dimensions in mm

Part No.	A max.	B max.	C max.	D max.	E	F	G max.	H
ZJYS51R5-2P(T), -2PB(T), -2PL(T), 5103-2PL(T)*	5.5	6.86	4.57	5.08	1.3	2.54±0.25	9±0.5	0.25
ZJYS51R5-4P(T), -M4PA(T)	10.5	6.86	4.57	5.08	1.3	2.54±0.25	9±0.5	0.25
ZJYS5105-2PL(T)	10.5	7.5	4.57	5.08	1.3	7.62±0.25	9±0.5	0.25
ZJYS81R5-2PL25(T)-G01, -2PL51(T)-G01	6	7.1	4.5	5	1.3	2.54±0.25	9±0.5	0.25

* T means the taping product.

EMC Components

ZJYS Series ZJYS51, ZJYS81 Types

Common Mode Choke Coils for Signal Line SMD

CIRCUIT DIAGRAMS

ZJYS51R5-2P(T),
-2PB(T), -2PL(T)

ZJYS5103-2PL(T)

ZJYS81R5-2PL25(T)-G01

ZJYS81R5-2PL51(T)-G01

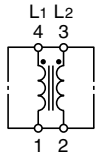

ZJYS51R5-4P(T)

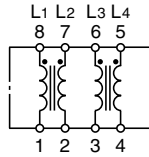

ZJYS51R5-M4PA(T)

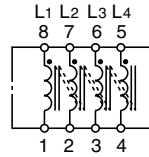

ZJYS5105-2PL(T)

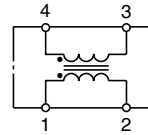

ELECTRICAL CHARACTERISTICS

Part No.	ZJYS51R5-2P(T), -2PB(T)*1, -2PL(T)*2, -4P(T)	ZJYS5103-2PL(T)	ZJYS51R5-M4PA(T)
Rated voltage Edc(V)	50	50	50
Rated current (A)	2	3	0.5
Test voltage Edc(V) [Between terminals for 5s]	125	125	125
Insulation resistance (MΩ) [Between terminals at DC.50V for 1min]	100min.	100min.	100min.
DC resistance (Ω) [Each line]	0.06max.	0.03max.	0.2max.
Operating temperature range (°C)	-25 to +85	-25 to +85	-25 to +85
Impedance (Ω) [+5 to +35°C]	200min.[20 to 300MHz]	100min.[100 to 300MHz]	200min.[20 to 300MHz]

Part No.	ZJYS5105-2PL(T)	ZJYS81R5-2PL25(T)-G01/-2PL51(T)-G01
Rated voltage Edc(V)	50	80
Rated current (A)	5	0.5
Test voltage Edc(V) [Between terminals for 5s]	125	200
Insulation resistance (MΩ) [Between terminals at DC.50V for 1min]	100min.	100min.
DC resistance (Ω) [Each line]	0.01max.	0.25/0.3max.
Operating temperature range (°C)	-25 to +85	-40 to +125
Impedance (Ω) [+5 to +35°C]	100min.[100 to 300MHz]	600min./1000min.[10 to 100MHz]

*1 The characteristics of low area reform type.

*2 Separate winding type (for communications).

• The "T" designation at the end of the product code indicates tape mounting.

TYPICAL ELECTRICAL CHARACTERISTICS

IMPEDANCE CHARACTERISTICS (for 1 element)

ZJYS51R5-2P, -4P

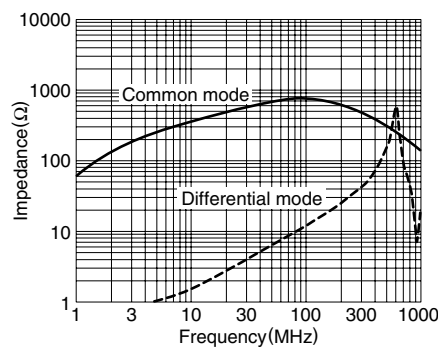

ZJYS51R5-2PB

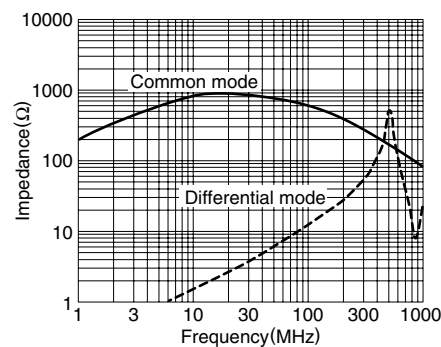

ZJYS51R5-2PL

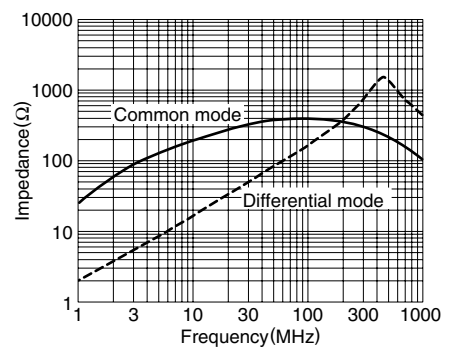

EMC Components

ZJYS Series ZJYS51, ZJYS81 Types

Common Mode Choke Coils for Signal Line SMD

TYPICAL ELECTRICAL CHARACTERISTICS

IMPEDANCE CHARACTERISTICS (for 1 element)

ZJYS5103-2PL

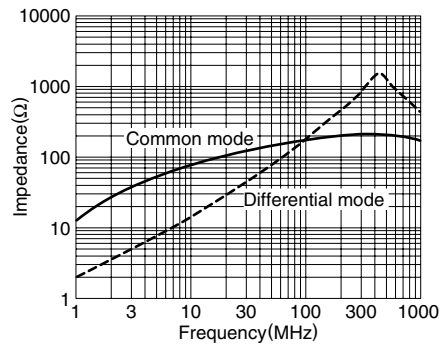

ZJYS5105-2PL

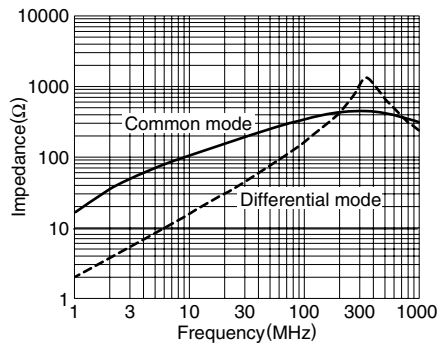

ZJYS51R5-M4PA

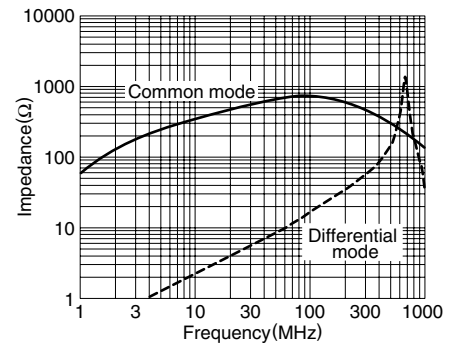

ZJYS81R5-2PL25-G01

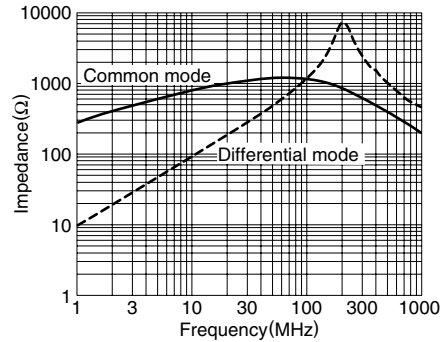

ZJYS81R5-2PL51-G01

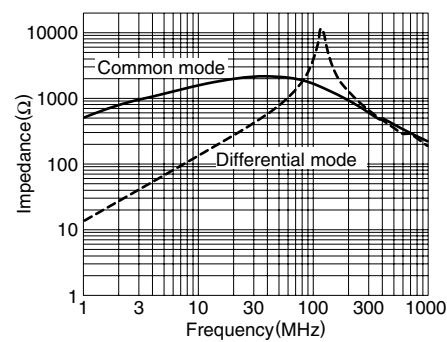

MEASURING CIRCUIT

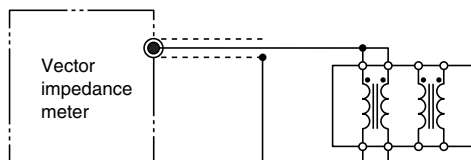

Vector impedance meter (YHP 4191A equivalent)
Measuring at each Common mode choke coil

PACKAGING STYLE AND QUANTITIES

Part No.	Taping (/reel)	Bulk
ZJYS51R5-2P(T)	1500 pieces	200 pieces
ZJYS51R5-2PB(T)	1500 pieces	200 pieces
ZJYS51R5-2PL(T)	1500 pieces	200 pieces
ZJYS5103-2PL(T)	1500 pieces	200 pieces
ZJYS81R5-2PL25(T)-G01	1500 pieces	200 pieces
ZJYS81R5-2PL51(T)-G01	1500 pieces	200 pieces
ZJYS51R5-4P(T)	1000 pieces	100 pieces
ZJYS51R5-M4PA(T)	1000 pieces	100 pieces
ZJYS5105-2PL(T)	1000 pieces	100 pieces

EMC Components

ZJYS Series ZJYS51, ZJYS81 Types

Common Mode Choke Coils for Signal Line SMD

TYPICAL APPLICATION

An application example showing how radiation noise is prevented when transmitter and receiver are connected via twisted pair cabling.

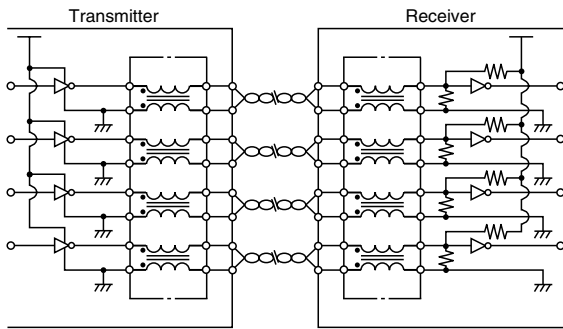

TYPICAL APPLICATION EFFECTS

(a) Without EMC filter

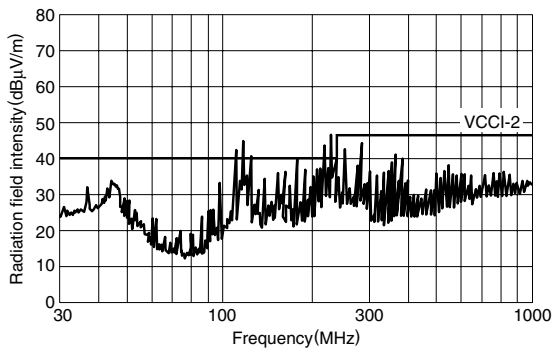

(b) With EMC filter ZJYS51R5-2P(T), 4P(T)

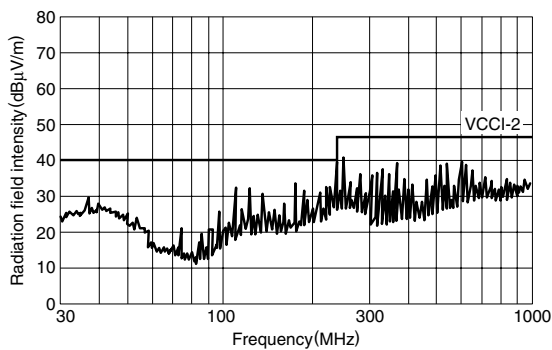

X-ON Electronics

Largest Supplier of Electrical and Electronic Components

Click to view similar products for [Common Mode Filters / Chokes](#) category:

Click to view products by [TDK](#) manufacturer:

Other Similar products are found below :

[74279408](#) [8109-RC](#) [8121-RC](#) [PE-62911NL](#) [PE-64683](#) [RD5122-6-9M6](#) [RD6137-6-7M5](#) [RD8147-16-3M0](#) [B82722A2801N020](#)
[B82723A2802N001](#) [B82723J2802N001](#) [B82726S2183N020](#) [T8114NLT](#) [RD5122-10-6M0](#) [RD7147-25-0M7](#) [B82724J2502U040](#)
[B82725S2103N004](#) [B82731M2401A033](#) [B82792C0506N365](#) [IND-0110](#) [CMC-03](#) [8117-RC](#) [PE-67531](#) [B82732R2601B30](#)
[B82794C0686N465](#) [2752041447](#) [2752045447](#) [CMS3-11-R](#) [23Z109SMNL-T](#) [009968H](#) [014660H](#) [057966E](#) [CM9900-224](#) [CPFC74NP-](#)
[PS01H2A30](#) [CPFC805NP-100M05](#) [EXC-24CD121U](#) [EXC-24CD201U](#) [EXC-24CD600U](#) [B82723A2602N001](#) [B82730U3162A020](#)
[B82730U3951A020](#) [DKFP-6248-0102](#) [DKFP-6248-02D5](#) [DKFP-6248-D504](#) [7448640395](#) [ELF-14M080E](#) [ELF-18D214](#) [ELF-18D217](#) [ELF-](#)
[18D218](#) [ELF-18D227F](#)