

# Genesys™

**Programmable DC Power Supplies**  
**750W in a 1U half-rack size**  
**Built in RS-232 & RS-485 Interface**  
**Parallel Current Summing**  
**Optional Interfaces: USB**  
**LXI Compliant LAN**  
**IEEE488.2 SCPI Multi-Drop**  
**Isolated Analog Interface**



## **Genesys™ Family**

**GEN H 750W Half Rack**

**GEN 1U 750/1500W Full Rack**

**GEN 2U 3.3/5kW**

**GEN 3U 10/15kW**

**TDK-Lambda**

[www.us.tdk-lambda.com/hp](http://www.us.tdk-lambda.com/hp)

The Genesys™ family of programmable power supplies sets a new standard for flexible, reliable, AC/DC power systems in Test & Measurement, Industrial and Laboratory applications.

## Features include:

- High Power Density 750W in 1U half-rack size
- Wide Range Input (85 - 265Vac Continuous)
- Active Power Factor Correction (0.99 typical)
- Output Voltage up to 600V, Current up to 100A
- Built-in RS-232/RS-485 Interface Standard
- Last Setting Memory; Front Panel Lockout
- Advanced Parallel reports total current up to four identical units
- Global Commands for Serial RS-232/RS-485 Interface
- Reliable Encoders for Voltage and Current Adjustment
- Constant Voltage/Constant Current auto-crossover
- Independent Remote ON/OFF and Remote Enable/Disable
- External Analog Programming and Monitoring
- Reliable Modular and SMT Design
- Side-by-side mounting of two units in a 19" rack
- Optional Interfaces
  - Isolated Analog Program /Monitor
  - IEEE Multi-Drop - SCPI
  - LXI** LAN Interface    USB Interface
- LabView® and LabWindows® drivers
- Five Year Warranty

Worldwide Safety Agency Approvals; CE Mark for LVD and EMC Regulation



## Front Panel Description

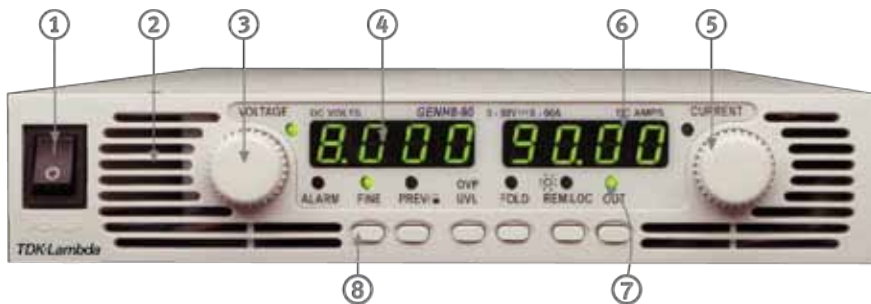

1. AC ON/OFF Switch
2. Air Intake allows zero stacking for maximum system flexibility and power density.
3. Reliable encoder controls Output Voltage and sets Address.
4. Volt Display shows Output Voltage and directly displays OVP, UVL and Address settings.
5. Reliable encoder controls Output Current, sets Baudrate, and Advanced Parallel Mode
6. Current Display shows Output Current and displays Baudrate.
7. Function/Status LEDs:
  - Alarm
  - Fine Control
  - Preview Settings
  - Foldback Mode
  - Remote Mode
  - Output On
8. Pushbuttons allow flexible user configuration
  - Coarse and fine Adjustment of Output Voltage/Current and Advanced Parallel Master or Slave select.
  - Preview settings and set Voltage/Current with Output OFF, Front Panel Lockout
  - Set OVP and UVL Limits
  - Set Current Foldback
  - Local/Remote Mode and select Address and Baudrate
  - Output ON/OFF and Auto-Start/Safe-Start Mode

## Applications

Genesys™ power supplies are designed for demanding applications. Common controls are shared across all platforms.

### Test & Measurement

Last-Setting memory simplifies test design and requires no battery backup.

Built-in RS-232/RS-485 gives maximum system flexibility along with 0-5V and 0-10V, selectable analog programming.

Wide range of available outputs allows testing of many different devices.

### Semiconductor Processing & Burn-in

Equipment designers appreciate the wide range Input (85-265Vac) and numerous Outputs from which to select depending on application.

Selectable Safe and Auto Re-start protects loads and process integrity. Typical applications include Magnets, Filaments and Heaters.

### Aerospace & Satellite Testing

Complex systems use the complete Genesys™ Family: 1U 750W Half Rack, 1U 750W or 1500W Full-Rack, 2U 3.3kW and 3U 10/15kW.

All are identical in Front Panel, Rear Panel Analog and Digital Interface Commands. A wide variety of outputs allows testing of many different devices.

### Laser Diode

OVP is directly set on Voltage Display, assuring accurate protection settings.

Current Limit Fold Back assures load is protected from current surges.

### Heater Supplies

Smooth, reliable encoders with selectable Fine and Coarse adjustment enhance Front Panel Control. Remote Analog Programming is user selectable 0-5V or 0-10V and optional Isolated Programming/Monitoring Interfaces are also available.

### RF Amplifiers and Magnets

Robust design assures stable operation under a wide variety of loads.

High linearity in voltage and current mode.

### Medical Imaging & Treatment Systems

Users require reliable power. Modular construction, SMT and thoroughly proven designs assure continuous performance at full rated power.

## Rear Panel Description

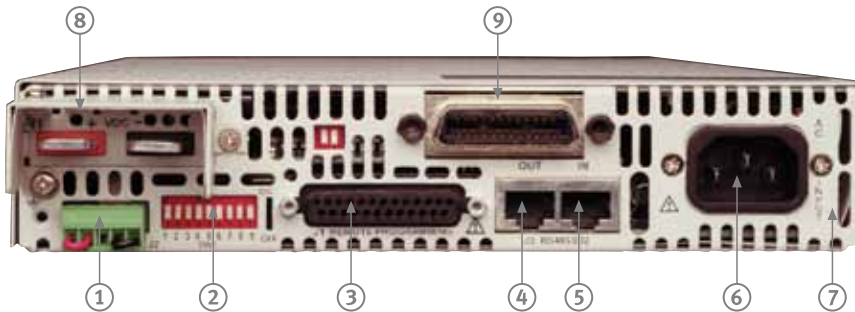

1. Remote/Local Output Voltage Sense Connections.
2. DIP Switches select 0-5V or 0-10V Programming and other functions.
3. DB25 (Female) connector allows (Non-isolated) Analog Program and Monitor and other functions.
4. RS-485 OUT to other Genesys™ Power Supplies.
5. RS-232/RS-485 IN Remote Serial Programming.
6. Wide-Range Input 85-265VAC continuous, 47/63Hz with Active Power Factor Correction (0.99 typical)  
AC Input Connector: IEC320.
7. Exit air assures reliable operation when zero stacked.
8. Output Connections: Rugged busbars for 6V up to 60V Output; Connector for Outputs >60V.
9. Optional Interface Position for IEEE 488.2 SCPI (shown), Isolated Analog Interface, LAN Interface or USB Interface.

LAN Interface complies with **LXI** Class C Specification

# Genesys™ GENH750W Specifications

1.0 MODEL	GENH	6-100	8-90	12.5-60	20-38	30-25	40-19	60-12.5	80-9.5	100-7.5	150-5	300-2.5	600-1.3
1.Rated output voltage (*1)	V	6	8	12.5	20	30	40	60	80	100	150	300	600
2.Rated Output Current (*2)	A	100	90	60	38	25	19	12.5	9.5	7.5	5	2.5	1.3
3.Rated Output Power	W	600	720	750	760	750	760	750	760	750	750	750	780
4.Efficiency at 100/200Vac (*3)	%	76/78	78/81	81/84	82/85	82/85	83/87	83/87	83/87	83/87	83/87	83/87	83/87

## 1.1 CONSTANT VOLTAGE MODE

1.Max line regulation ( 0.01% of Vo+ 2mV )(*4)	mV	2.6	2.8	3.3	4	5	6	8	10	12	17	32	62		
2.Max load regulation ( 0.01% of Vo+2mV )(*5)	mV	2.6	2.8	3.3	4	5	6	8	10	12	17	32	62		
3.Ripple and noise p-p 20MHz (*9)	mV	60	60	60	60	60	60	60	80	80	100	150	300		
4.Ripple r.m.s 5Hz~1MHz (*9)	mV	8	8	8	8	8	8	8	8	8	10	25	60		
5.Remote sense compensation/line	V	1	1	1	1	1.5	2	3	4	5	5	5	5		
6.Temp. coefficient	PPM/°C	100PPM/°C of rated output voltage, following 30 minutes warm up													
7.Up-prog. response time, 0~Vo Rated	mS	80mS , N.L./F.L , resistive load						150mS , N.L./F.L , resistive load						250	
8.Down-prog response time full-load	mS	10	50				80				150				250
9.Down-prog response time no-load	mS	500	600	700	800	900	1000	1100	1200	1500	2000	2500	4000		
10.Transient response time (*8)		Less than 1mSec for models up to and including 100V. 2msec for models above 100V													

## 1.2 CONSTANT CURRENT MODE

1.Max line regulation (0.01% of Io+ 2mA)(*4)	mA	12	11	8.0	5.8	4.5	3.9	3.25	2.95	2.75	2.5	2.25	2.13
2.Max.load regulation (0.02% of Io+5mA)(*6)	mA	25	23	17	12.6	10	8.8	7.5	6.9	6.5	6.0	5.5	5.26
3.Ripple r.m.s 5Hz~1MHz . (*7)	mA	200	180	120	76	63	48	38	29	23	18	13	8
4.Temp. coefficient	PPM/°C	100PPM/°C from rated output current, following 30 minutes warm up											

## 1.3 PROTECTIVE FUNCTIONS

1. OCP	0~105% Constant Current												
2. OCP Foldback	Output shut down when power supply change from CV to CC. User selectable.												
3. OVP type	Inverter shut-down, manual reset by AC input recycle or by OUT button or by communication port												
4. OVP trip point	0.5~7.5V	0.5~10V	1~15V	1~24V	2~36V	2~44V	5~66V	5~88V	5~110V	5~165V	5~330V	5~660V	
5. Over Temp. Protection	User selectable , latched or non latched												

## 1.4 ANALOG PROGRAMMING AND MONITORING

1.Vout Voltage Programming	0~100%, 0~5V or 0~10V, user select. Accuracy and linearity: +/-0.5% of rated Vout.												
2.Iout Voltage Programming	0~100%, 0~5V or 0~10V, user select. Accuracy and linearity: +/-1% of rated Iout.												
3.Vout Resistor Programming	0~100%, 0~5/10Kohm full scale, user select. Accuracy and linearity: +/-1% of rated Vout.												
4.Iout Resistor Programming	0~100%, 0~5/10Kohm full scale, user select. Accuracy and linearity: +/-1.5% of rated Iout.												
5.On/Off control (rear panel)	By electrical. Voltage: 0~0.6V/2~15V, or dry contact, user selectable logic												
6.Output Current monitor	0~5V or 0~10V , accuracy:1%, user selectable												
7.Output Voltage monitor	0~5V or 0~10V , accuracy:1%, user selectable												
8.Power Supply OK signal	TTL High=OK, 0V-Fail 500ohm impedance												
9. CV/CC indicator	CV: TTL high (4~5V) source: 10mA, CC: TTL low (0~0.6V) sink current:10mA												
10. Enable/Disable	Dry contact. Open: off , Short: on. Max. voltage at Enable/Disable in: 6V												
11. Local/Remote analog control	By electrical signal or Open/Short: 0~0.6V or short: Remote analog, 4~5V or open: Local.												
12. Local/Remote analog control indicator	Open collector, Local: Open, Remote: On. Maximum voltage: 30V, maximum sink current: 5mA.												

## 1.5 FRONT PANEL

1.Control functions	Vout/ Iout manual adjust by separate encoders (coarse and fine adjustment selectable) OVP/UVL manual adjust by Volt. Adjust encoder AC on/off, Output on/off, Re-start modes (auto, safe), Foldback control (CV to CC), Go to local control Front Panel Lock Address selection by Voltage (or current) adjust encoder. Number of addresses:31 RS232/485 and IEEE488.2 selection by IEEE enable switch and DIP switch Baudrate selection: 1200,2400,4800,9600 and 19,200												
2.Display	Voltage 4 digits , accuracy: 0.5%+/-1 count Current 4 digits, accuracy: 0.5%+/-1 count												
3.Indications	Voltage, Current, Alarm, Fine, Preview, Foldback, Local, Output On, Front Panel Lock												

## 1.6 Interface RS-232&RS-485 or Optional GPIB Interface

Model	V	6	8	12.5	20	30	40	60	80	100	150	300	600
<b>1. Remote Voltage Programming (16 bit)</b>													
Resolution (0.012% of Vo Rated)	mV	0.72	0.96	1.50	2.40	3.60	4.80	7.2	9.6	12	18	36	72
Accuracy (0.05%Vo Rated+0.05% of Vo Actual Output)	mV	6.0	8.0	12.5	20	30	40	60	80	100	150	300	600
<b>2. Remote Current Programming (16 bit)</b>													
Resolution (0.012% of Io Rated)	mA	12	10.8	7.2	4.56	3.0	2.28	1.50	1.14	0.90	0.60	0.30	0.16
Accuracy (0.1% of Io Rated+0.1% of Io Actual Output)	mA	200	180	120	76	50	38	25	19	15	10	5.0	2.6
<b>3. Readback Voltage</b>													
Resolution (0.012% of Vo Rated)	mV	0.72	0.96	1.50	2.40	3.60	4.80	7.2	9.6	12	18	36	72
Accuracy (0.1%Vo Rated+0.1% of Vo Actual Output)	mV	12	16	25	40	60	80	120	160	200	300	600	1200
<b>4. Readback Current</b>													
Resolution (0.012% of Io Rated)	mA	12	10.8	7.2	4.56	3.0	2.28	1.50	1.14	0.90	0.60	0.30	0.16
Accuracy (0.3% of Io Rated+0.1% of Io Actual Output)	mA	400	360	240	152	100	76	50	38	30	20	10	5.2
<b>5. OVP/UVL Programming</b>													
Resolution (0.1% of Vo Rated)	mV	6	8	12	20	30	40	60	80	100	150	300	600
Accuracy (1% of Vo Rated)	mV	60	80	125	200	300	400	600	800	1000	1500	3000	6000

\*1: Minimum voltage is guaranteed to maximum 0.2% of Vo Rated.

\*2: Minimum current is guaranteed to maximum 0.4% of Io Rated

\*3: At maximum output power.

\*4: 85~132Vac or 170~265Vac, constant load.

\*5: From No-load to Full-load, constant input voltage.

\*6: For load voltage change, equal to the unit voltage rating, constant input voltage.

\*7: For 6V models the ripple is measured at 2~6V output voltage and full output current. For other models, the ripple is measured at 10~100% output voltage and full output current.

\*8: Time for the output voltage to recover within 0.5% of its rated for a load change 10~90% of rated output current, Output set-point:10~100%.

\*9: For 6V~300V models: measured with JEITA RC-9131A 1:1 probe. For 600V model: measured with 10:1 probe

Accuracy -Values have been calculated at Vo Rated & Io Rated

# General Specifications Genesys™ GENH750W

## 2.1 INPUT CHARACTERISTICS

1. Input voltage/freq. (*1)	85~265Vac continuous, 47~63Hz, single phase
2. Power Factor	0.99 @100/200Vac, rated output power.
3. EN61000-3-2,3 compliance	Complies with EN61000-3-2 class A and EN61000-3-3 at 20~100% output power.
4. Input current 100/200Vac	10.5A / 5A,
5. Inrush current 100/200Vac	Less than 25A,
6. Hold-up time	More than 20mS , 100Vac , at 100% load.

## 2.2 POWER SUPPLY CONFIGURATION

1. Parallel Operation	Up to 4 identical units in master/slave mode with parallel current summing (Advanced Parallel)
2. Series Operation	Up to 2 units. with external diodes. 600V Max to Chassis ground

## 2.3 ENVIRONMENTAL CONDITIONS

1. Operating temp	0~50 C, 100% load.
2. Storage temp	-20~70 C
3. Operating humidity	30~90% RH (non-condensing).
4. Storage humidity	10~95% RH (non-condensing).
5. Vibration	MIL-810E, method 514.4 , test cond. I-3.3.1. The EUT is fixed to the vibrating surface.
6. Shock	Less than 20G , half sine , 11mSec. Unit is unpacked.
7. Altitude	Operating: 10000ft (3000m), Derate output current by 2%/100m above 2000m, Non operating: 40000ft (12000m).

## 2.4 EMC

1. Applicable Standards:	
2. ESD	IEC1000-4-2. Air-disch.-8KV, contact disch.-4KV
3. Fast transients	IEC1000-4-4. 2KV
4. Surge immunity	IEC1000-4-5. 1KV line to line, 2KV line to ground
5. Conducted immunity	IEC1000-4-6, 3V
6. Radiated immunity	IEC1000-4-3, 3V/m
7. Conducted emission	EN55022B, FCC part 15-B, VCCI-B
8. Radiated emission	EN55022A, FCC part 15-A, VCCI-A
9. Voltage dips	EN61000-4-11
10. Conducted emission	EN55022B, FCC part 15-B, VCCI-B.
11. Radiated emission	EN55022A, FCC part 15-A, VCCI-A.

## 2.5 SAFETY

1. Applicable standards:	CE Mark, UL60950, EN60950 listed . Vout<60V: Output is SELV , IEEE/Isolated analog are SELV. 60<Vout<400V: Output is hazardous, IEEE/Isolated analog are SELV. 400<Vout<600V: Output is hazardous, IEEE/Isolated analog are not SELV.
2. Withstand voltage	Vout<60V models : Input-Outputs (SELV): 3.0KVrms 1min, Input-Ground: 2.0KVrms 1min. 60<Vout<600V models: Input-Haz. Output: 2.5KVrms 1min, Input-SELV: 3KVrms 1min. Hazardous Output.-SELV: 1.9KVrms 1min, Hazardous Output-Ground: 1.9KVrms 1min. Input-Ground: 2KVrms 1min.
3. Insulation resistance	More than 100Mohm at 25 C , 70% RH, 500Vdc

## 2.6 MECHANICAL CONSTRUCTION

1. Cooling	Forced air flow: from front to rear. No ventilation holes at the top or bottom of the chassis; Variable fan speed.
2. Dimensions (WxHxD)	W: 214.0mm (8.43"), H: 43.6mm (1.716"), (57.0mm (2.24") Benchtop version), D: 437.5mm (17.22") (excluding connectors, encoders, handles, etc.)
3. Weight	4.5Kg (9.9 Lbs)
4. AC Input connector	IEC320 AC Inlet.
5. Output connectors	6V to 60V models: Bus-bars (hole Ø 6.5mm). 80V to 600V models: Mating plug, Phoenix P/N: GIC 2.5/4-ST-7.62.

## 2.7 RELIABILITY SPECS

1. Warranty	5 years.
-------------	----------

\*1: For cases where conformance to various safety standards (UL, IEC etc.) is required, to be described as 100-240Vac (50/60Hz)  
All specifications subject to change without notice.

**Also Available Genesys™  
1U 750W/1500W, 2U3.3/5kW and 3U 10/15kW**



# Genesys™ Power Benchtop Parallel and Series Configurations

## Parallel operation - Master/ Slave:

Active current sharing allows up to 4 units to be connected in an auto-parallel configuration for four times the output power.

**In Advanced Parallel Master/Slave Mode, total current is programmed and reported by the Master. Up to four supplies act as one.**

## Series Operation

Up to two units may be connected in series to increase the output voltage or to provide bipolar output. (Max 600V to Chassis Ground).



## Remote Programming via RS-232 & RS-485 Interface

Standard Serial Interface allows chain control of up to 31 power supplies on the same bus with built-in RS-232 & RS-485 Interface with or without Multi-Drop option.

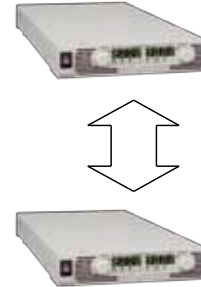
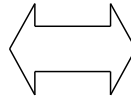

## Programming Options (Factory installed)

### New IEEE Multi-Drop Interface

- Allows IEEE Master to control up to 30 (Multi-Drop equipped) slaves over RS-485
- Only the Master needs be equipped with IEEE Interface
- IEEE 488.2 SCPI Compliant
- Program Voltage
- Measure Voltage
- Over Voltage setting and shutdown
- Error and Status Messages
- Program Current
- Measure Current
- Current Foldback shutdown

P/N: IEMD

### New Multi-Drop Slave Option

- Slaves need to be equipped with the MD Slave (RS485) option

P/N: MD

### Isolated Analog Programming

- Four Channels to Program and Monitor Voltage and Current.
- Isolation allows operation with floating references in harsh electrical environments.
- Choose between programming with Voltage or Current.
- Connection via removable terminal block: Phoenix MC1,5/8-ST-3.81.
- Voltage Programming, user-selectable 0-5V or 0-10V signal.  
Power supply Voltage and Current Programming Accuracy  $\pm 1\%$   
Power supply Voltage and Current Monitoring Accuracy  $\pm 1.5\%$
- Current Programming with 4-20mA signal.  
Power supply Voltage and Current Programming Accuracy  $\pm 1\%$   
Power supply Voltage and Current Monitoring Accuracy  $\pm 1.5\%$

P/N: IS510

P/N: IS420

### LAN Interface

### **LXI** Compliant to Class C

- Meets all LXI-C Requirements
- Address Viewable on Front Panel
- Fixed and Dynamic Addressing
- Fast Startup
- Meets all LXI-C Requirements
- LAN Fault Indicators
- Auto-detects LAN Cross-over Cable
- Compatible with most standard Networks

P/N: LAN

### USB Interface

- Allows Serial Connection to USB Port on computer
- Serial commands same as (standard) RS-232/RS-485 Interface

P/N: USB

## Accessories

### Rack Mounting applications *P/N:GENH/RM*

The Rack Mounted kit allows the units to be zero stacking for maximum system flexibility and power density without increasing the 1U height of the units

To install one GENH750W unit or two units side-by-side in a standard 19" rack in 1U(1.75") height, use option kit *P/N:GENH/RM*

#### Single unit installation

Single GENH750W power supply in a standard 19" rack in 1U(1.75") height,



#### Dual unit installation

Two GENH750W power supplies side-by-side in a standard 19" rack in 1U(1.75") height,



### Benchtop applications *P/N: GENH/MO*

The benchtop stacking kit allows the units to be Zero stacked for maximum system flexibility and power density without increasing the 1U height of the units.

To install a GENH750W two units or three units one on top of the other use option kit *P/N:GENH/MO*



### Communication cable

RS-232/RS-485 Cable is used to connect the power supply to the PC Controller.

Mode	RS-485	RS-232	RS-232
PC Connector	DB-9F	DB-9F	DB-25F
Communication Cable	Shield Ground L=2m	Shield Ground L=2m	FShield Ground L=2m
Power Supply Connector	EIA/TIA-568A (RJ-45)	EIA/TIA-568A (RJ-45)	EIA/TIA-568A (RJ-45)
P/N	GEN/485-9	GEN/232-9	GEN/232-25

### Serial link cable\*

Daisy-chain up to 31 Genesys<sup>a</sup> power supplies.

Mode	Power Supply Connector	Communication Cable	P/N
RS-485	EIA/TIA-568A (RJ-45)	Shield Ground L=50cm	GEN/RJ45

\* Included with power supply

# Outline Drawings Genesys™ GENH 750W

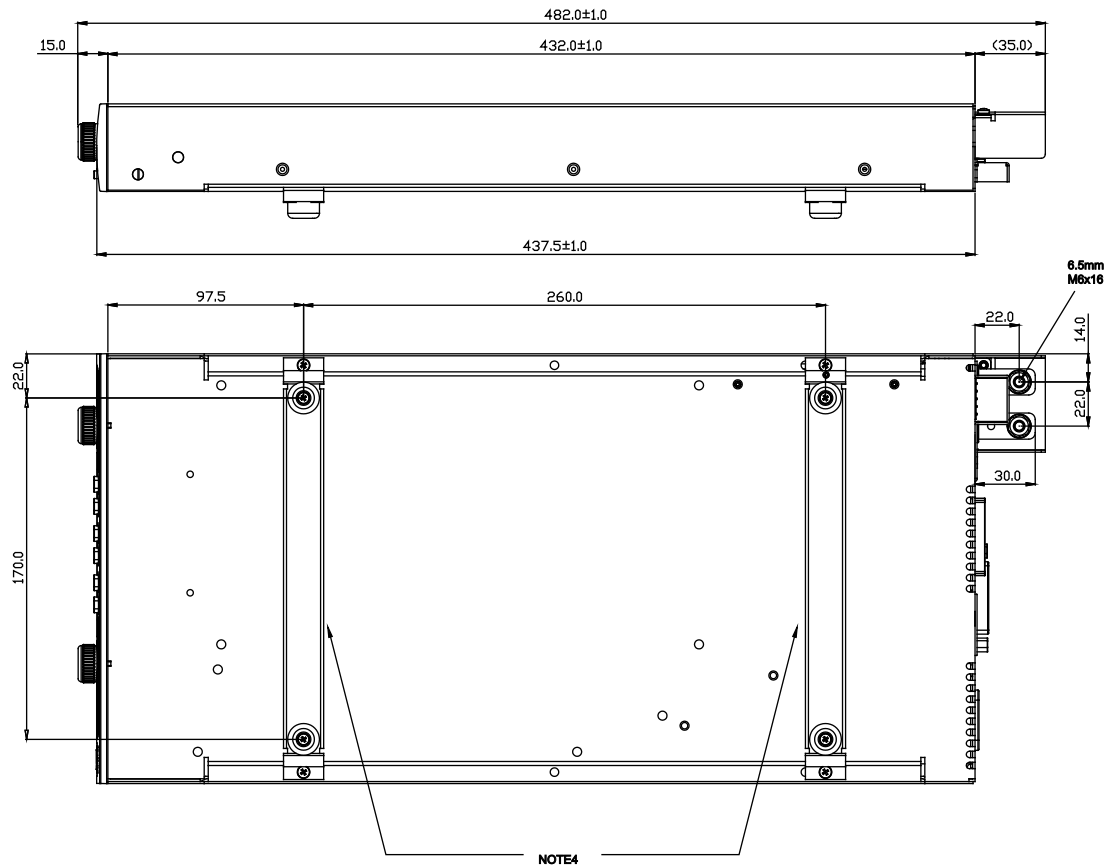
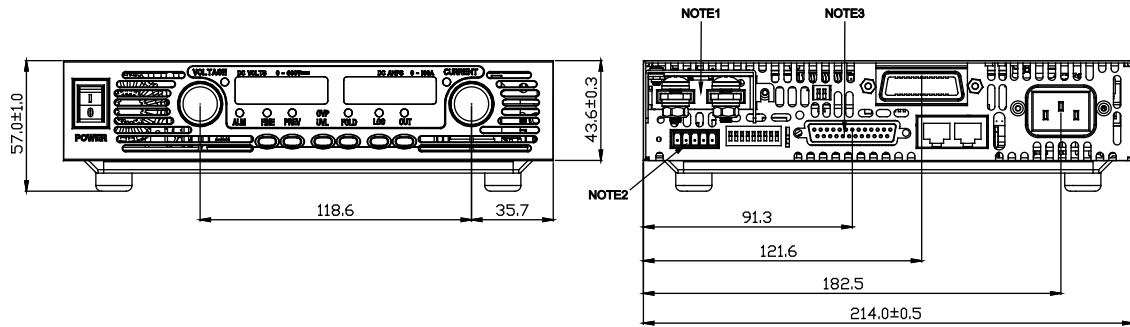

## NOTE 1

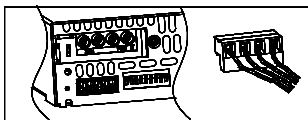

GENH Models 80V to 600V.

## NOTES:

1. Bus-bars 6V to 60V models  
Connector 80V to 600V model  
Header Phoenix P/N: GIC 2.5/4-G-7.62  
Mating plug Phoenix P/N: GIC 2.5/4-ST-7.62
2. Mating plug Phoenix P/N: MC1.5/5-ST-3.81
3. Mating plug AMP P/N: 745211-2  
Mating plugs supplied with power supply.
4. Benchtop assembly x 2 (removable)  
Screws: 4 x M3x8 marked "A".  
Supplied with the power supply.



# Power Supply Identification / Accessories

## How to order

<b>GENH</b>	<b>60</b>	-	<b>12.5</b>	-	-
Series Name	Output Voltage (0~60V)		Output Current (0~12.5A)		
				Factory Options Option: IEMD MD IS510 IS420 LAN USB	AC Cable option Region: E - Europe GB - United Kingdom J - Japan I - Middle East U - North America

## Models GENH750W





Model	Output Voltage VDC	Output Current (A)	Output Power (W)
GENH6-100	0~6V	0~100	600
GENH8-90	0~8V	0~90	720
GENH12.5-60	0~12.5V	0~60	750
GENH20-38	0~20V	0~38	760
GENH30-25	0~30V	0~25	750
GENH40-19	0~40V	0~19	760
GENH60-12.5	0~60V	0~12.5	750
GENH80-9.5	0~80V	0~9.5	760
GENH100-7.5	0~100V	0~7.5	750
GENH150-5	0~150V	0~5	750
GENH300-2.5	0~300V	0~2.5	750
GENH600-1.3	0~600V	0~1.3	780

### Factory option

RS-232/RS-485 Interface built-in Standard	-
GPIOB (Multi-Drop Master) Interface	IEMD
Multi-Drop Slave Interface	MD
Voltage Programming Isolated Analog Interface	IS510
Current Programming Isolated Analog Interface	IS420
LAN Interface (Complies with <b>LXI</b> Class C)	LAN
USB Interface	USB

### P/N

## AC Cords sets

Region	Europe	United Kingdom	Japan	Middle East	North America
Output Power	750W	750W	750W	750W	750W
AC Cords	10A/250Vac L=2m	10A/250Vac L=2m	13A/125Vac L=2m	10A/250Vac L=2m	13A/125Vac L=2m
Wall Plug	INT'L 7/VII	BS1363		SI-32	NEMA 5-15P
Power Supply Connector	IEC320-C13 	IEC320-C13 	IEC320-C13 	IEC320-C13 	IEC320-C13 
Part Number	P/N: GEN/E	P/N: GEN/GB	P/N: GEN/J	P/N: GEN/I	P/N: GEN/U

## X-ON Electronics

Largest Supplier of Electrical and Electronic Components

*Click to view similar products for [Benchtop Power Supplies](#) category:*

*Click to view products by [TDK-Lambda](#) manufacturer:*

Other Similar products are found below :

[NL200](#) [PR20](#) [ZUPNC403](#) [ZUP/W](#) [ZUPNC402](#) [TL89F2](#) [TL89K1](#) [TL89T1](#) [1332A-NIST](#) [ACC-GENH/RM](#) [P 6300](#) [SPE3102](#) [SPE3103](#)  
[SPE6103](#) [P 5995](#) [CPX200DP](#) [AX-3003P](#) [AX-6003P](#) [AX-8450A](#) [TPM-3003](#) [HMC8012](#) [HMP2020](#) [HMP2030](#) [HMP4040](#) [1350](#) [UT804](#)  
[1410](#) [XLNRC](#) [1513](#) [1514](#) [1550](#) [1651A](#) [1652](#) [1665](#) [1666](#) [1667](#) [1693](#) [1694](#) [1698](#) [MX100TP](#) [FLUKE 8845A/SU](#) [1737](#) [1739](#) [1762](#) [1788](#)  
[TPM-3005](#) [1902B](#) [9174B](#) [GDM-8245](#) [GDM-8255A](#)