

Genesys™

Programmable DC Power Supplies
750W in a 1U half-rack size
Built in RS-232 & RS-485 Interface
Parallel Current Summing
Optional Interfaces: USB
LXI Compliant LAN
IEEE488.2 SCPI Multi-Drop
Isolated Analog Interface



Genesys™ Family

GEN H 750W Half Rack

GEN 1U 750/1500W Full Rack

GEN 2U 3.3/5kW

GEN 3U 10/15kW

TDK-Lambda

www.us.tdk-lambda.com/hp

The Genesys™ family of programmable power supplies sets a new standard for flexible, reliable, AC/DC power systems in Test & Measurement, Industrial and Laboratory applications.

Features include:

- High Power Density 750W in 1U half-rack size
- Wide Range Input (85 - 265Vac Continuous)
- Active Power Factor Correction (0.99 typical)
- Output Voltage up to 600V, Current up to 100A
- Built-in RS-232/RS-485 Interface Standard
- Last Setting Memory; Front Panel Lockout
- Advanced Parallel reports total current up to four identical units
- Global Commands for Serial RS-232/RS-485 Interface
- Reliable Encoders for Voltage and Current Adjustment
- Constant Voltage/Constant Current auto-crossover
- Independent Remote ON/OFF and Remote Enable/Disable
- External Analog Programming and Monitoring
- Reliable Modular and SMT Design
- Side-by-side mounting of two units in a 19" rack
- Optional Interfaces
 - Isolated Analog Program /Monitor
 - IEEE Multi-Drop - SCPI
 - LXI** LAN Interface USB Interface
- LabView® and LabWindows® drivers
- Five Year Warranty

Worldwide Safety Agency Approvals; CE Mark for LVD and EMC Regulation



Front Panel Description

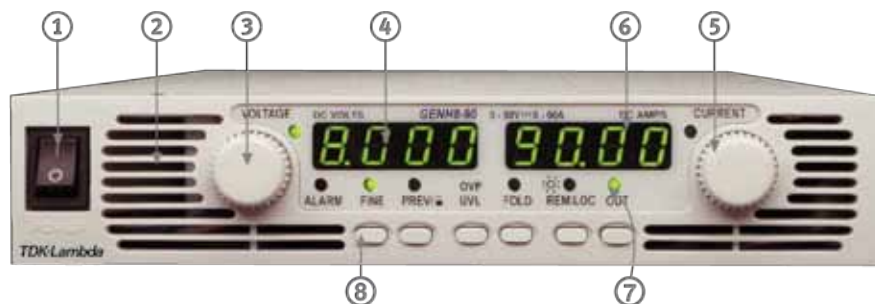

1. AC ON/OFF Switch
2. Air Intake allows zero stacking for maximum system flexibility and power density.
3. Reliable encoder controls Output Voltage and sets Address.
4. Volt Display shows Output Voltage and directly displays OVP, UVL and Address settings.
5. Reliable encoder controls Output Current, sets Baudrate, and Advanced Parallel Mode
6. Current Display shows Output Current and displays Baudrate.
7. Function/Status LEDs:
 - Alarm
 - Fine Control
 - Preview Settings
 - Foldback Mode
 - Remote Mode
 - Output On
8. Pushbuttons allow flexible user configuration
 - Coarse and fine Adjustment of Output Voltage/Current and Advanced Parallel Master or Slave select.
 - Preview settings and set Voltage/Current with Output OFF, Front Panel Lockout
 - Set OVP and UVL Limits
 - Set Current Foldback
 - Local/Remote Mode and select Address and Baudrate
 - Output ON/OFF and Auto-Start/Safe-Start Mode

Applications

Genesys™ power supplies are designed for demanding applications. Common controls are shared across all platforms.

Test & Measurement

Last-Setting memory simplifies test design and requires no battery backup.

Built-in RS-232/RS-485 gives maximum system flexibility along with 0-5V and 0-10V, selectable analog programming.

Wide range of available outputs allows testing of many different devices.

Semiconductor Processing & Burn-in

Equipment designers appreciate the wide range Input (85-265Vac) and numerous Outputs from which to select depending on application.

Selectable Safe and Auto Re-start protects loads and process integrity. Typical applications include Magnets, Filaments and Heaters.

Aerospace & Satellite Testing

Complex systems use the complete Genesys™ Family: 1U 750W Half Rack, 1U 750W or 1500W Full-Rack, 2U 3.3kW and 3U 10/15kW.

All are identical in Front Panel, Rear Panel Analog and Digital Interface Commands. A wide variety of outputs allows testing of many different devices.

Laser Diode

OVP is directly set on Voltage Display, assuring accurate protection settings.

Current Limit Fold Back assures load is protected from current surges.

Heater Supplies

Smooth, reliable encoders with selectable Fine and Coarse adjustment enhance Front Panel Control. Remote Analog Programming is user selectable 0-5V or 0-10V and optional Isolated Programming/Monitoring Interfaces are also available.

RF Amplifiers and Magnets

Robust design assures stable operation under a wide variety of loads.

High linearity in voltage and current mode.

Medical Imaging & Treatment Systems

Users require reliable power. Modular construction, SMT and thoroughly proven designs assure continuous performance at full rated power.

Rear Panel Description

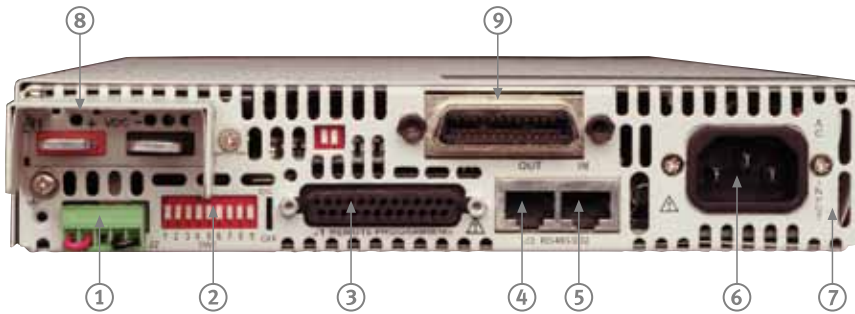

1. Remote/Local Output Voltage Sense Connections.
2. DIP Switches select 0-5V or 0-10V Programming and other functions.
3. DB25 (Female) connector allows (Non-isolated) Analog Program and Monitor and other functions.
4. RS-485 OUT to other Genesys™ Power Supplies.
5. RS-232/RS-485 IN Remote Serial Programming.
6. Wide-Range Input 85-265VAC continuous, 47/63Hz with Active Power Factor Correction (0.99 typical)
AC Input Connector: IEC320.
7. Exit air assures reliable operation when zero stacked.
8. Output Connections: Rugged busbars for 6V up to 60V Output; Connector for Outputs >60V.
9. Optional Interface Position for IEEE 488.2 SCPI (shown), Isolated Analog Interface, LAN Interface or USB Interface.

LAN Interface complies with **LXI** Class C Specification

Genesys™ GENH750W Specifications

| 1.0 MODEL | GENH | 6-100 | 8-90 | 12.5-60 | 20-38 | 30-25 | 40-19 | 60-12.5 | 80-9.5 | 100-7.5 | 150-5 | 300-2.5 | 600-1.3 |
|---------------------------------|------|-------|-------|---------|-------|-------|-------|---------|--------|---------|-------|---------|---------|
| 1.Rated output voltage (*1) | V | 6 | 8 | 12.5 | 20 | 30 | 40 | 60 | 80 | 100 | 150 | 300 | 600 |
| 2.Rated Output Current (*2) | A | 100 | 90 | 60 | 38 | 25 | 19 | 12.5 | 9.5 | 7.5 | 5 | 2.5 | 1.3 |
| 3.Rated Output Power | W | 600 | 720 | 750 | 760 | 750 | 760 | 750 | 760 | 750 | 750 | 750 | 780 |
| 4.Efficiency at 100/200Vac (*3) | % | 76/78 | 78/81 | 81/84 | 82/85 | 82/85 | 83/87 | 83/87 | 83/87 | 83/87 | 83/87 | 83/87 | 83/87 |

1.1 CONSTANT VOLTAGE MODE

| | | | | | | | | | | | | | | | |
|------------------------------------------------|--------|----------------------------------------------------------------------------------|-----|-----|-----|-----|------|------------------------------------|------|------|------|------|------|-----|-----|
| 1.Max line regulation (0.01% of Vo+ 2mV)(*4) | mV | 2.6 | 2.8 | 3.3 | 4 | 5 | 6 | 8 | 10 | 12 | 17 | 32 | 62 | | |
| 2.Max load regulation (0.01% of Vo+2mV)(*5) | mV | 2.6 | 2.8 | 3.3 | 4 | 5 | 6 | 8 | 10 | 12 | 17 | 32 | 62 | | |
| 3.Ripple and noise p-p 20MHz (*9) | mV | 60 | 60 | 60 | 60 | 60 | 60 | 60 | 80 | 80 | 100 | 150 | 300 | | |
| 4.Ripple r.m.s 5Hz~1MHz (*9) | mV | 8 | 8 | 8 | 8 | 8 | 8 | 8 | 8 | 8 | 10 | 25 | 60 | | |
| 5.Remote sense compensation/line | V | 1 | 1 | 1 | 1 | 1.5 | 2 | 3 | 4 | 5 | 5 | 5 | 5 | | |
| 6.Temp. coefficient | PPM/°C | 100PPM/°C of rated output voltage, following 30 minutes warm up | | | | | | | | | | | | | |
| 7.Up-prog. response time, 0~Vo Rated | mS | 80mS , N.L./F.L. , resistive load | | | | | | 150mS , N.L./F.L. , resistive load | | | | | | 250 | |
| 8.Down-prog response time full-load | mS | 10 | 50 | | | | 80 | | | | 150 | | | | 250 |
| 9.Down-prog response time no-load | mS | 500 | 600 | 700 | 800 | 900 | 1000 | 1100 | 1200 | 1500 | 2000 | 2500 | 4000 | | |
| 10.Transient response time (*8) | | Less than 1mSec for models up to and including 100V. 2msec for models above 100V | | | | | | | | | | | | | |

1.2 CONSTANT CURRENT MODE

| | | | | | | | | | | | | | |
|----------------------------------------------|--------|-------------------------------------------------------------------|-----|-----|------|-----|-----|------|------|------|-----|------|------|
| 1.Max line regulation (0.01% of Io+ 2mA)(*4) | mA | 12 | 11 | 8.0 | 5.8 | 4.5 | 3.9 | 3.25 | 2.95 | 2.75 | 2.5 | 2.25 | 2.13 |
| 2.Max.load regulation (0.02% of Io+5mA)(*6) | mA | 25 | 23 | 17 | 12.6 | 10 | 8.8 | 7.5 | 6.9 | 6.5 | 6.0 | 5.5 | 5.26 |
| 3.Ripple r.m.s 5Hz~1MHz . (*7) | mA | 200 | 180 | 120 | 76 | 63 | 48 | 38 | 29 | 23 | 18 | 13 | 8 |
| 4.Temp. coefficient | PPM/°C | 100PPM/°C from rated output current, following 30 minutes warm up | | | | | | | | | | | |

1.3 PROTECTIVE FUNCTIONS

| | | | | | | | | | | | | | |
|--------------------------|------------------------------------------------------------------------------------------------|---------|-------|-------|-------|-------|-------|-------|--------|--------|--------|--------|--|
| 1. OCP | 0~105% Constant Current | | | | | | | | | | | | |
| 2. OCP Foldback | Output shut down when power supply change from CV to CC. User selectable. | | | | | | | | | | | | |
| 3. OVP type | Inverter shut-down, manual reset by AC input recycle or by OUT button or by communication port | | | | | | | | | | | | |
| 4. OVP trip point | 0.5~7.5V | 0.5~10V | 1~15V | 1~24V | 2~36V | 2~44V | 5~66V | 5~88V | 5~110V | 5~165V | 5~330V | 5~660V | |
| 5. Over Temp. Protection | User selectable , latched or non latched | | | | | | | | | | | | |

1.4 ANALOG PROGRAMMING AND MONITORING

| | | | | | | | | | | | | | |
|-------------------------------------------|--------------------------------------------------------------------------------------------|--|--|--|--|--|--|--|--|--|--|--|--|
| 1.Vout Voltage Programming | 0~100%, 0~5V or 0~10V, user select. Accuracy and linearity: +/-0.5% of rated Vout. | | | | | | | | | | | | |
| 2.Iout Voltage Programming | 0~100%, 0~5V or 0~10V, user select. Accuracy and linearity: +/-1% of rated Iout. | | | | | | | | | | | | |
| 3.Vout Resistor Programming | 0~100%, 0~5/10Kohm full scale, user select. Accuracy and linearity: +/-1% of rated Vout. | | | | | | | | | | | | |
| 4.Iout Resistor Programming | 0~100%, 0~5/10Kohm full scale, user select. Accuracy and linearity: +/-1.5% of rated Iout. | | | | | | | | | | | | |
| 5.On/Off control (rear panel) | By electrical. Voltage: 0~0.6V/2~15V, or dry contact, user selectable logic | | | | | | | | | | | | |
| 6.Output Current monitor | 0~5V or 0~10V , accuracy:1%, user selectable | | | | | | | | | | | | |
| 7.Output Voltage monitor | 0~5V or 0~10V , accuracy:1%, user selectable | | | | | | | | | | | | |
| 8.Power Supply OK signal | TTL High=OK, 0V-Fail 500ohm impedance | | | | | | | | | | | | |
| 9. CV/CC indicator | CV: TTL high (4~5V) source: 10mA, CC: TTL low (0~0.6V) sink current:10mA | | | | | | | | | | | | |
| 10. Enable/Disable | Dry contact. Open: off , Short: on. Max. voltage at Enable/Disable in: 6V | | | | | | | | | | | | |
| 11. Local/Remote analog control | By electrical signal or Open/Short: 0~0.6V or short: Remote analog, 4~5V or open: Local. | | | | | | | | | | | | |
| 12. Local/Remote analog control indicator | Open collector, Local: Open, Remote: On. Maximum voltage: 30V, maximum sink current: 5mA. | | | | | | | | | | | | |

1.5 FRONT PANEL

| | | | | | | | | | | | | | |
|---------------------|-------------------------------------------------------------------------------------------------------------------------------------------------------------------------------------------------------------------------------------------------------------------------------------------------------------------------------------------------------------------------------------------------------------------------------------------------------------------------------------------|--|--|--|--|--|--|--|--|--|--|--|--|
| 1.Control functions | Vout/ Iout manual adjust by separate encoders (coarse and fine adjustment selectable) OVP/UVL manual adjust by Volt. Adjust encoder AC on/off, Output on/off, Re-start modes (auto, safe), Foldback control (CV to CC), Go to local control Front Panel Lock Address selection by Voltage (or current) adjust encoder. Number of addresses:31 RS232/485 and IEEE488.2 selection by IEEE enable switch and DIP switch Baudrate selection: 1200,2400,4800,9600 and 19,200 | | | | | | | | | | | | |
| 2.Display | Voltage 4 digits , accuracy: 0.5%+/-1 count Current 4 digits, accuracy: 0.5%+/-1 count | | | | | | | | | | | | |
| 3.Indications | Voltage, Current, Alarm, Fine, Preview, Foldback, Local, Output On, Front Panel Lock | | | | | | | | | | | | |

1.6 Interface RS-232&RS-485 or Optional GPIB Interface

| Model | V | 6 | 8 | 12.5 | 20 | 30 | 40 | 60 | 80 | 100 | 150 | 300 | 600 |
|------------------------------------------------------|----|------|------|------|------|------|------|------|------|------|------|------|------|
| 1. Remote Voltage Programming (16 bit) | | | | | | | | | | | | | |
| Resolution (0.012% of Vo Rated) | mV | 0.72 | 0.96 | 1.50 | 2.40 | 3.60 | 4.80 | 7.2 | 9.6 | 12 | 18 | 36 | 72 |
| Accuracy (0.05%Vo Rated+0.05% of Vo Actual Output) | mV | 6.0 | 8.0 | 12.5 | 20 | 30 | 40 | 60 | 80 | 100 | 150 | 300 | 600 |
| 2. Remote Current Programming (16 bit) | | | | | | | | | | | | | |
| Resolution (0.012% of Io Rated) | mA | 12 | 10.8 | 7.2 | 4.56 | 3.0 | 2.28 | 1.50 | 1.14 | 0.90 | 0.60 | 0.30 | 0.16 |
| Accuracy (0.1% of Io Rated+0.1% of Io Actual Output) | mA | 200 | 180 | 120 | 76 | 50 | 38 | 25 | 19 | 15 | 10 | 5.0 | 2.6 |
| 3. Readback Voltage | | | | | | | | | | | | | |
| Resolution (0.012% of Vo Rated) | mV | 0.72 | 0.96 | 1.50 | 2.40 | 3.60 | 4.80 | 7.2 | 9.6 | 12 | 18 | 36 | 72 |
| Accuracy (0.1%Vo Rated+0.1% of Vo Actual Output) | mV | 12 | 16 | 25 | 40 | 60 | 80 | 120 | 160 | 200 | 300 | 600 | 1200 |
| 4. Readback Current | | | | | | | | | | | | | |
| Resolution (0.012% of Io Rated) | mA | 12 | 10.8 | 7.2 | 4.56 | 3.0 | 2.28 | 1.50 | 1.14 | 0.90 | 0.60 | 0.30 | 0.16 |
| Accuracy (0.3% of Io Rated+0.1% of Io Actual Output) | mA | 400 | 360 | 240 | 152 | 100 | 76 | 50 | 38 | 30 | 20 | 10 | 5.2 |
| 5. OVP/UVL Programming | | | | | | | | | | | | | |
| Resolution (0.1% of Vo Rated) | mV | 6 | 8 | 12 | 20 | 30 | 40 | 60 | 80 | 100 | 150 | 300 | 600 |
| Accuracy (1% of Vo Rated) | mV | 60 | 80 | 125 | 200 | 300 | 400 | 600 | 800 | 1000 | 1500 | 3000 | 6000 |

*1: Minimum voltage is guaranteed to maximum 0.2% of Vo Rated.

*2: Minimum current is guaranteed to maximum 0.4% of Io Rated

*3: At maximum output power.

*4: 85~132Vac or 170~265Vac, constant load.

*5: From No-load to Full-load, constant input voltage.

*6: For load voltage change, equal to the unit voltage rating, constant input voltage.

*7: For 6V models the ripple is measured at 2~6V output voltage and full output current. For other models, the ripple is measured at 10~100% output voltage and full output current.

*8: Time for the output voltage to recover within 0.5% of its rated for a load change 10~90% of rated output current, Output set-point:10~100%.

*9: For 6V~300V models: measured with JEITA RC-9131A 1:1 probe. For 600V model: measured with 10:1 probe

Accuracy -Values have been calculated at Vo Rated & Io Rated

General Specifications Genesys™ GENH750W

2.1 INPUT CHARACTERISTICS

| | |
|------------------------------|----------------------------------------------------------------------------|
| 1. Input voltage/freq. (*1) | 85~265Vac continuous, 47~63Hz, single phase |
| 2. Power Factor | 0.99 @100/200Vac, rated output power. |
| 3. EN61000-3-2,3 compliance | Complies with EN61000-3-2 class A and EN61000-3-3 at 20~100% output power. |
| 4. Input current 100/200Vac | 10.5A / 5A, |
| 5. Inrush current 100/200Vac | Less than 25A, |
| 6. Hold-up time | More than 20mS , 100Vac , at 100% load. |

2.2 POWER SUPPLY CONFIGURATION

| | |
|-----------------------|------------------------------------------------------------------------------------------------|
| 1. Parallel Operation | Up to 4 identical units in master/slave mode with parallel current summing (Advanced Parallel) |
| 2. Series Operation | Up to 2 units. with external diodes. 600V Max to Chassis ground |

2.3 ENVIRONMENTAL CONDITIONS

| | |
|-----------------------|------------------------------------------------------------------------------------------------------------|
| 1. Operating temp | 0~50 C, 100% load. |
| 2. Storage temp | -20~70 C |
| 3. Operating humidity | 30~90% RH (non-condensing). |
| 4. Storage humidity | 10~95% RH (non-condensing). |
| 5. Vibration | MIL-810E, method 514.4 , test cond. I-3.3.1. The EUT is fixed to the vibrating surface. |
| 6. Shock | Less than 20G , half sine , 11mSec. Unit is unpacked. |
| 7. Altitude | Operating: 10000ft (3000m), Derate output current by 2%/100m above 2000m, Non operating: 40000ft (12000m). |

2.4 EMC

| | |
|--------------------------|---------------------------------------------------|
| 1. Applicable Standards: | |
| 2. ESD | IEC1000-4-2. Air-disch.-8KV, contact disch.-4KV |
| 3. Fast transients | IEC1000-4-4. 2KV |
| 4. Surge immunity | IEC1000-4-5. 1KV line to line, 2KV line to ground |
| 5. Conducted immunity | IEC1000-4-6, 3V |
| 6. Radiated immunity | IEC1000-4-3, 3V/m |
| 7. Conducted emission | EN55022B, FCC part 15-B, VCCI-B |
| 8. Radiated emission | EN55022A, FCC part 15-A, VCCI-A |
| 9. Voltage dips | EN61000-4-11 |
| 10. Conducted emission | EN55022B, FCC part 15-B, VCCI-B. |
| 11. Radiated emission | EN55022A, FCC part 15-A, VCCI-A. |

2.5 SAFETY

| | |
|--------------------------|--------------------------------------------------------------------------------------------------------------------------------------------------------------------------------------------------------------------------------------------------------------------------------------|
| 1. Applicable standards: | CE Mark, UL60950, EN60950 listed . Vout<60V: Output is SELV , IEEE/Isolated analog are SELV. 60<Vout<400V: Output is hazardous, IEEE/Isolated analog are SELV. 400<Vout<600V: Output is hazardous, IEEE/Isolated analog are not SELV. |
| 2. Withstand voltage | Vout<60V models :Input-Outputs (SELV): 3.0KVrms 1min, Input-Ground: 2.0KVrms 1min. 60<Vout<600V models: Input-Haz. Output: 2.5KVrms 1min, Input-SELV: 3KVrms 1min. Hazardous Output.-SELV: 1.9KVrms 1min, Hazardous Output-Ground:1.9KVrms 1min. Input-Ground: 2KVrms 1min. |
| 3. Insulation resistance | More than 100Mohm at 25 C , 70% RH, 500Vdc |

2.6 MECHANICAL CONSTRUCTION

| | |
|-----------------------|------------------------------------------------------------------------------------------------------------------------------------------------|
| 1. Cooling | Forced air flow: from front to rear. No ventilation holes at the top or bottom of the chassis; Variable fan speed. |
| 2. Dimensions (WxHxD) | W: 214.0mm (8.43"), H: 43.6mm (1.716"), (57.0mm (2.24") Benchtop version), D: 437.5mm (17.22") (excluding connectors, encoders, handles, etc.) |
| 3. Weight | 4.5Kg (9.9 Lbs) |
| 4. AC Input connector | IEC320 AC Inlet. |
| 5. Output connectors | 6V to 60V models: Bus-bars (hole Ø 6.5mm). 80V to 600V models: Mating plug, Phoenix P/N: GIC 2.5/4-ST-7.62. |

2.7 RELIABILITY SPECS

| | |
|-------------|----------|
| 1. Warranty | 5 years. |
|-------------|----------|

*1: For cases where conformance to various safety standards (UL, IEC etc.) is required, to be described as 100-240Vac (50/60Hz)
All specifications subject to change without notice.

**Also Available Genesys™
1U 750W/1500W, 2U3.3/5kW and 3U 10/15kW**



Genesys™ Power Benchtop Parallel and Series Configurations

Parallel operation - Master/ Slave:

Active current sharing allows up to 4 units to be connected in an auto-parallel configuration for four times the output power.

In Advanced Parallel Master/Slave Mode, total current is programmed and reported by the Master. Up to four supplies act as one.

Series Operation

Up to two units may be connected in series to increase the output voltage or to provide bipolar output. (Max 600V to Chassis Ground).



Remote Programming via RS-232 & RS-485 Interface

Standard Serial Interface allows chain control of up to 31 power supplies on the same bus with built-in RS-232 & RS-485 Interface with or without Multi-Drop option.

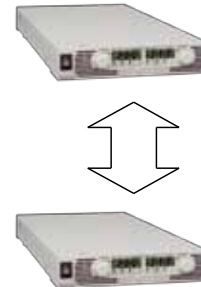
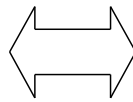

Programming Options (Factory installed)

New IEEE Multi-Drop Interface

P/N: IEMD

- Allows IEEE Master to control up to 30 (Multi-Drop equipped) slaves over RS-485
- Only the Master needs be equipped with IEEE Interface
- IEEE 488.2 SCPI Compliant
- Program Voltage
- Measure Voltage
- Over Voltage setting and shutdown
- Error and Status Messages
- Program Current
- Measure Current
- Current Foldback shutdown

New Multi-Drop Slave Option

P/N: MD

- Slaves need to be equipped with the MD Slave (RS485) option

Isolated Analog Programming

- Four Channels to Program and Monitor Voltage and Current.
- Isolation allows operation with floating references in harsh electrical environments.
- Choose between programming with Voltage or Current.
- Connection via removable terminal block: Phoenix MC1,5/8-ST-3.81.
- Voltage Programming, user-selectable 0-5V or 0-10V signal.
Power supply Voltage and Current Programming Accuracy $\pm 1\%$
Power supply Voltage and Current Monitoring Accuracy $\pm 1.5\%$
- Current Programming with 4-20mA signal.
Power supply Voltage and Current Programming Accuracy $\pm 1\%$
Power supply Voltage and Current Monitoring Accuracy $\pm 1.5\%$

P/N: IS510

P/N: IS420

LAN Interface

LXI Compliant to Class C

P/N: LAN

- Meets all LXI-C Requirements
- Address Viewable on Front Panel
- Fixed and Dynamic Addressing
- Fast Startup
- Meets all LXI-C Requirements
- LAN Fault Indicators
- Auto-detects LAN Cross-over Cable
- Compatible with most standard Networks

USB Interface

P/N: USB

- Allows Serial Connection to USB Port on computer
- Serial commands same as (standard) RS-232/RS-485 Interface

Accessories

Rack Mounting applications *P/N:GENH/RM*

The Rack Mounted kit allows the units to be zero stacking for maximum system flexibility and power density without increasing the 1U height of the units

To install one GENH750W unit or two units side-by-side in a standard 19" rack in 1U(1.75") height, use option kit *P/N:GENH/RM*

Single unit installation

Single GENH750W power supply in a standard 19" rack in 1U(1.75") height,



Dual unit installation

Two GENH750W power supplies side-by-side in a standard 19" rack in 1U(1.75") height,



Benchtop applications *P/N: GENH/MO*

The benchtop stacking kit allows the units to be Zero stacked for maximum system flexibility and power density without increasing the 1U height of the units.

To install a GENH750W two units or three units one on top of the other use option kit *P/N:GENH/MO*



Communication cable

RS-232/RS-485 Cable is used to connect the power supply to the PC Controller.

| Mode | RS-485 | RS-232 | RS-232 |
|------------------------|----------------------|----------------------|----------------------|
| PC Connector | DB-9F | DB-9F | DB-25F |
| Communication Cable | Shield Ground L=2m | Shield Ground L=2m | FShield Ground L=2m |
| Power Supply Connector | EIA/TIA-568A (RJ-45) | EIA/TIA-568A (RJ-45) | EIA/TIA-568A (RJ-45) |
| P/N | GEN/485-9 | GEN/232-9 | GEN/232-25 |

Serial link cable*

Daisy-chain up to 31 Genesys^a power supplies.

| Mode | Power Supply Connector | Communication Cable | P/N |
|--------|------------------------|----------------------|----------|
| RS-485 | EIA/TIA-568A (RJ-45) | Shield Ground L=50cm | GEN/RJ45 |

* Included with power supply

Outline Drawings Genesys™ GENH 750W

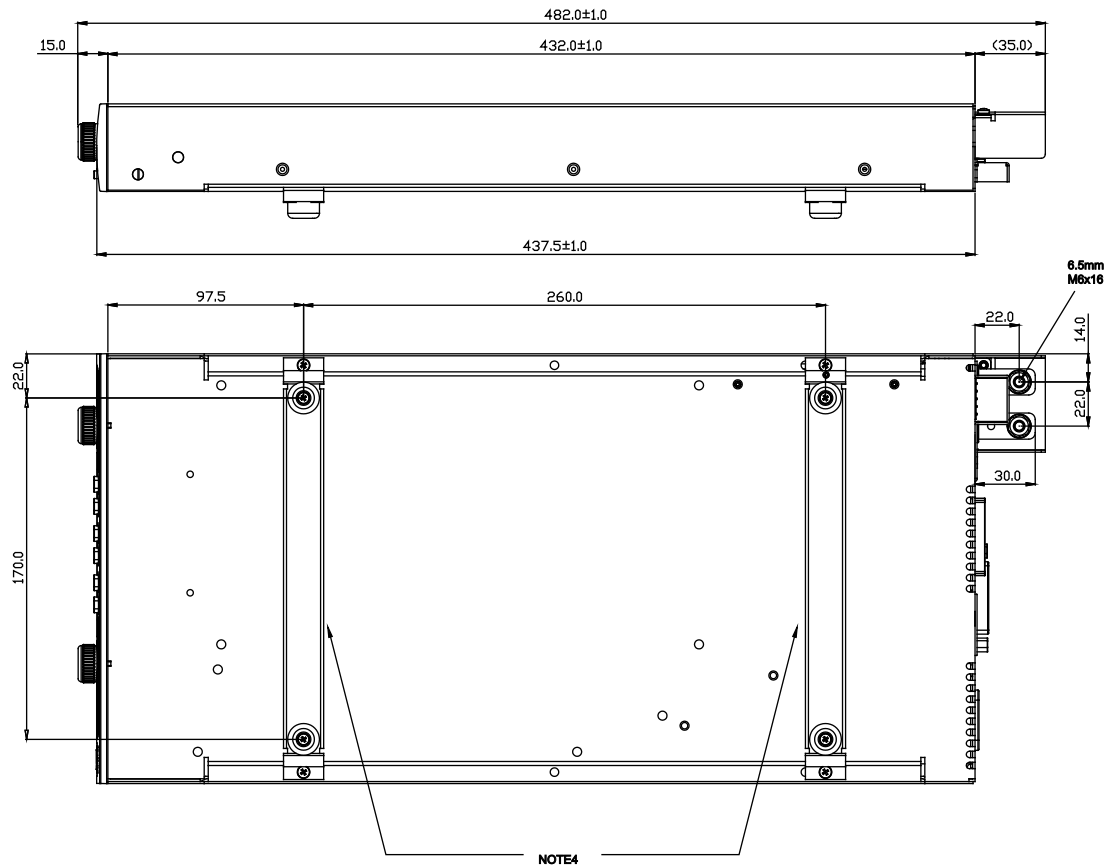
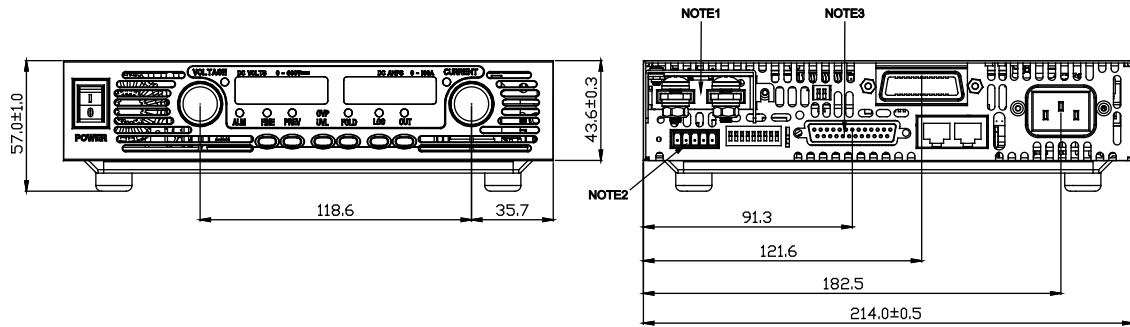

NOTE 1

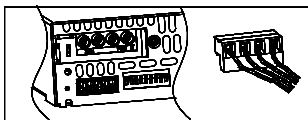

GENH Models 80V to 600V.

NOTES:

1. Bus-bars 6V to 60V models
Connector 80V to 600V model
Header Phoenix P/N: GIC 2.5/4-G-7.62
Mating plug Phoenix P/N: GIC 2.5/4-ST-7.62
2. Mating plug Phoenix P/N: MC1.5/5-ST-3.81
3. Mating plug AMP P/N: 745211-2
Mating plugs supplied with power supply.
4. Benchtop assembly x 2 (removable)
Screws: 4 x M3x8 marked "A".
Supplied with the power supply.

Power Supply Identification / Accessories

How to order

| | | | | | |
|-------------|------------------------|--------------------------|-----------------------------------------------------|----------------------------------------------------------------------------------------------------|---|
| GENH | 60 | - | 12.5 | - | - |
| Series Name | Output Voltage (0~60V) | Output Current (0~12.5A) | Factory Options Option: IEMD MD IS510 IS420 LAN USB | AC Cable option Region: E - Europe GB - United Kingdom J - Japan I - Middle East U - North America | |

Models GENH750W





| Model | Output Voltage VDC | Output Current (A) | Output Power (W) |
|-------------|--------------------|--------------------|------------------|
| GENH6-100 | 0~6V | 0~100 | 600 |
| GENH8-90 | 0~8V | 0~90 | 720 |
| GENH12.5-60 | 0~12.5V | 0~60 | 750 |
| GENH20-38 | 0~20V | 0~38 | 760 |
| GENH30-25 | 0~30V | 0~25 | 750 |
| GENH40-19 | 0~40V | 0~19 | 760 |
| GENH60-12.5 | 0~60V | 0~12.5 | 750 |
| GENH80-9.5 | 0~80V | 0~9.5 | 760 |
| GENH100-7.5 | 0~100V | 0~7.5 | 750 |
| GENH150-5 | 0~150V | 0~5 | 750 |
| GENH300-2.5 | 0~300V | 0~2.5 | 750 |
| GENH600-1.3 | 0~600V | 0~1.3 | 780 |

Factory option

| | |
|--------------------------------------------------|-------|
| RS-232/RS-485 Interface built-in Standard | - |
| GPIB (Multi-Drop Master) Interface | IEMD |
| Multi-Drop Slave Interface | MD |
| Voltage Programming Isolated Analog Interface | IS510 |
| Current Programming Isolated Analog Interface | IS420 |
| LAN Interface (Complies with LXI Class C) | LAN |
| USB Interface | USB |

P/N

AC Cords sets

| Region | Europe | United Kingdom | Japan | Middle East | North America |
|------------------------|---------------------------------------------------------------------------------------------------|---------------------------------------------------------------------------------------------------|---------------------------------------------------------------------------------------------------|-----------------------------------------------------------------------------------------------------|-----------------------------------------------------------------------------------------------------|
| Output Power | 750W | 750W | 750W | 750W | 750W |
| AC Cords | 10A/250Vac L=2m | 10A/250Vac L=2m | 13A/125Vac L=2m | 10A/250Vac L=2m | 13A/125Vac L=2m |
| Wall Plug | INT'L 7/VII | BS1363 | | SI-32 | NEMA 5-15P |
| Power Supply Connector | IEC320-C13  | IEC320-C13  | IEC320-C13  | IEC320-C13  | IEC320-C13  |
| Part Number | P/N: GEN/E | P/N: GEN/GB | P/N: GEN/J | P/N: GEN/I | P/N: GEN/U |

X-ON Electronics

Largest Supplier of Electrical and Electronic Components

Click to view similar products for [Benchtop Power Supplies](#) category:

Click to view products by [TDK-Lambda](#) manufacturer:

Other Similar products are found below :

[NL200](#) [PR20](#) [ZUPNC403](#) [ZUP/W](#) [ZUPNC402](#) [TL89F2](#) [TL89K1](#) [TL89T1](#) [1332A-NIST](#) [ACC-GENH/RM](#) [P 6300](#) [SPE3102](#) [SPE3103](#)
[SPE6103](#) [P 5995](#) [CPX200DP](#) [AX-3003P](#) [AX-6003P](#) [AX-8450A](#) [TPM-3003](#) [HMP2020](#) [HMP2030](#) [HMP4040](#) [1350](#) [UT804](#) [1410](#) [XLNRC](#)
[1513](#) [1514](#) [1550](#) [1651A](#) [1652](#) [1665](#) [1666](#) [1667](#) [1693](#) [1694](#) [1698](#) [MX100TP](#) [1739](#) [1762](#) [1788](#) [TPM-3005](#) [1902B](#) [9174B](#) [GDM-8245](#)
[GDM-8255A](#) [GDM-8341](#) [PSP-603](#) [PSW 160-7.2](#)