

HWS Series

AC-DC Switching Power Supply HWS·HWS/ME·HWS/HD·HWS-P



**Most Efficient Ever, Compact,
and Eco-friendly.**

HWS Series

WIDE SELECTION OF LINE UP RANGE FROM GENERAL INDUSTRIAL, MEDICAL, HEAVY DUTY TO POWER SUPPLY WITH PEAK OUTPUT

Concept

HWS Series put together the concept of "Environment-friendly", "User-friendly", and "Safety" as its foundation to offer wide range of product.

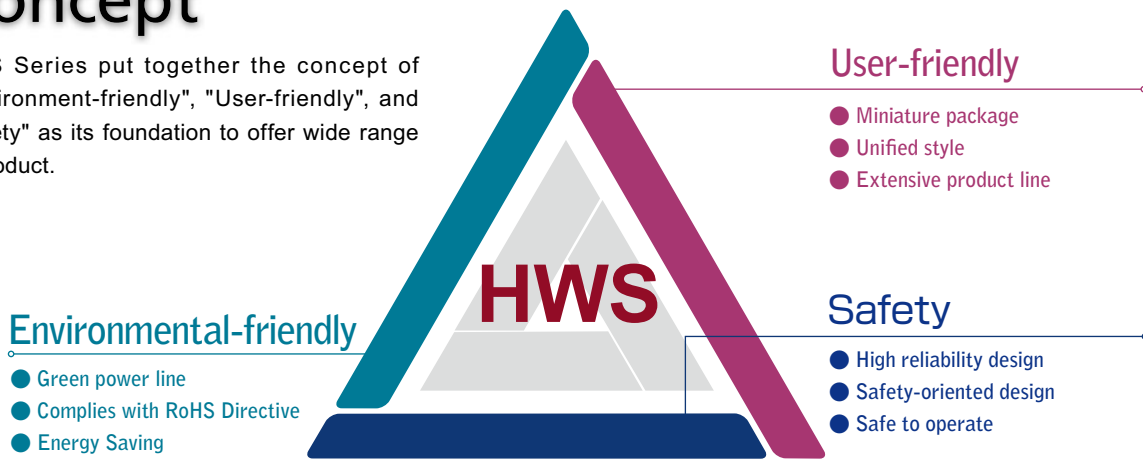

HWS Series Line Up

- HWS General industrial
- HWS/ME Medical standard (IEC60601) compliance
- HWS/HD Suitable for harsh environment/Heavy duty equipment
- HWS-P Peak power load

HWS Series Model Name

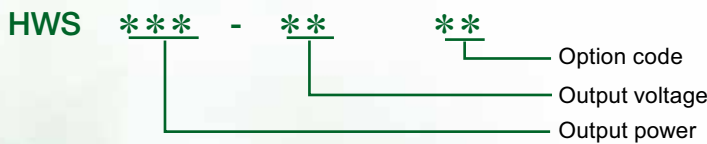

- **Output power**
In addition to 11 models for 15W ~ 1800W, there are 2 models for peak power models which bring the total of 13 models.
- **Output voltage**
Wide variety of line up from 3.3V to 48V. 60V is also available for 1000W and above models.
- **Option code**

Code	Contents
ME	EN/UL60601 Approved, low leakage current for medical application
HD	Double-sided coating and -40°C start up, suitable for harsh environment
A	Cover for additional safety operation
R	Remote ON/OFF by external voltage
ADIN	DIN Reel type
PV	External voltage adjustment
FG	Low leakage current type

*Not all models are available for above option and longer delivery might be needed for option models. Please contact our sales for more information

HWS AC/DC Switching Power Supply

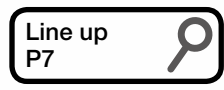

Environment-friendly

Complies to RoHS Directives

Energy saving

- Reducing power loss during operation through high efficient design.
- Fan will stop during output "OFF" initiated by remote ON/OFF.

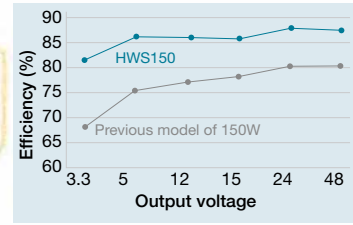
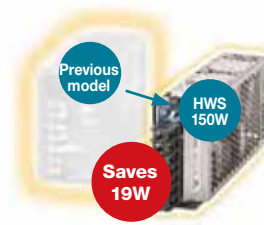

User-friendly

Exhaust type forced air cooling using built-in fans installed at the rear of the unit (300W - 1800W)

No space is required at the side between power supplies when multiple units are used. Built-in automated speed control fan contribute to low acoustic noise during normal temperature operation.



Miniature Package

By increasing efficiency and optimization of components and circuit design, we achieved over 50% miniaturization.

Miniaturization of over 50%

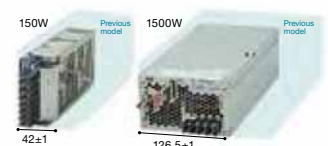

Unified style

Unified style of 82mm height make it more convenient in design when multiple units are used. All models can be embedded in 19-inch 2U rack mount



Safety

Reliability design

Long Life

105° long life elec. capacitors are used and design to operate for 24 hours/365 days continuously using guaranteed life time from component manufacturers.

High efficiency design

Synchronous rectification circuit is used in 3.3V/5V output to support lower voltage higher current. These products achieved more than 80% efficiency

Warranty: 5 years

Safety design

Designed to meet worldwide safety regulation. It also meet the requirement for CE marking, which is a safety standard in European Union.



Safety terminal

Previously, cover was required to ensure safety in the terminal. With safety terminal, live areas are covered by terminal block and direct contact with finger can be prevented (finger protection). With integral construction between screw and terminal, it will prevent the screw from dropping off into the unit (300W - 1800W type are using input terminal)

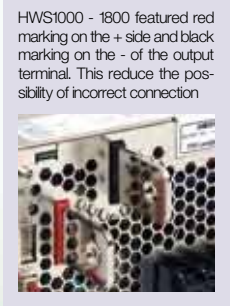
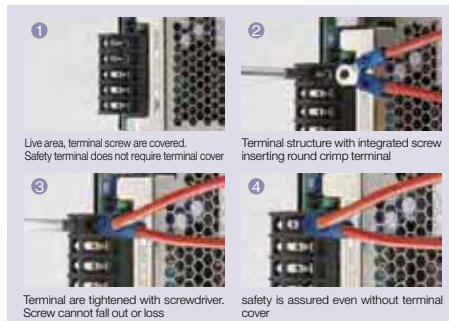

Safe operation

While swicthing power supply provide stable DC power, there are environmental condition requirement that unique to the different fields in which equipment is used.

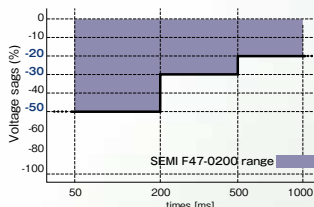

The momentary voltage drop (voltage sag) power supply fault that may occur due to certain natural disaster or lightning is a critical issue for semiconductor factories and semiconductor manufacturing equipment. The supply voltage sag (voltage drop) and duration is stipulated by the SEMIF47-0200, " Specification For Semiconductor Processing Equipment Voltage Sag Immunity" standard which is a US semiconductor equipment standard and can be met when 200VAC input is used.

HWS/ME

AC/DC Switching power supply for medical application

Era where standard power supply used in medical application

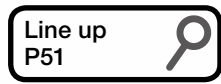

Medical safety standard (EN60601/UL60601) compliance

Contribute to shortened the time needed in developing medical equipment and reduce its cost

7 models with 42 line ups

Main applications

Medical lasers, X-Ray, Microwave therapy equipment

Diagnosis equipments, Analysis/testing devices

Leakage current: max. 0.5mA

100VAC(Typ): 0.2mA/30~150W, 0.15mA/300W, 0.12mA/600W, 0.2mA/1000~1500W
 230VAC(Typ): 0.4mA/30~150W, 0.39mA/300W, 0.34mA/600W, 0.4mA/1000~1500W

EMC

● Immunity (All models)

Items	Standard	Compliance Level	Notes
Electrostatic	IEC61000-4-2	Level3 (Level 2,3 for 300W, 600W)	Aerial discharge: 8kV Contact discharge:6kV (4kV for 1500W)
Radiated susceptibility	IEC61000-4-3	Level 3	10V/m
Electrical fast transient/burst	IEC61000-4-4	Level 3	2kV
Surge	IEC61000-4-5	Level 3,4	Common: 4.0kV Differential mode: 2.0kV
Conducted susceptibility	IEC61000-4-6	Level 3	10V
Power frequency magnetic field	IEC61000-4-8	Level 4	30A/m
Voltage dips. Short interruption	IEC61000-4-11	Complied	

● Emission (HWS30,50,100,150,300/ME)

Test items	Standard	Notes
Radiated electric field	EN55022/EN55011,FCC,VCCI	Class B Compliance
Conducted emissions	EN55022/EN55011,FCC,VCCI	Class B Compliance
Conducted harmonics	IEC61000-3-2	Conformed
Flicker	IEC61000-3-3	Conformed

● Emission (HWS 600,1500/ME)

Test items	Standard	Notes
Radiated electric field	EN55022/EN55011,FCC,VCCI	Class A Compliance
Conducted emissions	EN55022/EN55011,FCC,VCCI	Class A Compliance
Conducted harmonics	IEC61000-3-2	Conformed
Flicker	IEC61000-3-3	Conformed

Attention:

Please read the instruction manual carefully before using this product. On top of the following condition, please refer to to "HWS Series" standard instruction manual (p25-). Please confirm whether there is insulation materials used inside the equipment (whether there is patient direct contact or indirect contact with the equipment). All models are approved for basic insulation, therefore additional insulation circuit may be needed in the equipment.

HWS/HD

AC/DC Standard switching power supply for rugged and heavy duty

Harsh environment applications

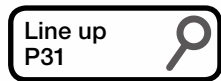

-40°C Start up

PCB coating

Designed to meet MIL-STD-810F (shock and vibration)

Main applications

LED display Device

Process control

Factory machinery

HWS-P

AC/DC Switching power supply with peak power capability

Support drive load with 3 times of peak power



- Up to 3 times of peak current
- High power in compact size
- Low acoustic noise with automated speed control fan

Main applications

- Factory machiney
- Semiconductor testing device
- Textile machinery, Cash dispenser

Up to 3 times peak current to give powerful support to motor and printer head application

High Reliability and User Friendly Power Supply for Drive Load Application

The growth of motor and printer head applications, the center of multifunction and high speed machineries, have been increased from year to year. HWS-P is superior to provide function to support instant current in typical drive load with up to 3 times peak current in compact size.

By taking into consideration on the demand of high reliability industrial equipment, elec. capacitor is expected to have 7 year of life (Ta=40°) . Also, 5 year warranty is provided.

The design include OCP circuit with shut off function, OVP circuit, temperature sensor for automatic speed control fan as well as built-in OTP circuit. All of these functions give a better safety and ease to the users.



Mode Output Voltage	HWS300P			HWS600P		
	Ave. output current	Peak current		Ave. output current	Peak current	
		100V input	200V input		100V input	200V input
24V	12.5A	21.0A	42.0A	25.0A	40.5A	83.0A
36V	8.4A	14.0A	28.0A	16.7A	27.0A	55.5A
48V	6.3A	10.5A	21.0A	12.5A	20.0A	41.5A

Contents

HWS	7
Specifications	
HWS15	8
HWS30	10
HWS50	12
HWS80	14
HWS100	16
HWS150	18
HWS300	20
HWS600	22
HWS1000	24
HWS1500	26
HWS1800T	28
HWS/HD	31
Specifications	
HWS30/HD	32
HWS50/HD	34
HWS100/HD	36
HWS150/HD	38
HWS300/HD	40
HWS600/HD	42
HWS1000/HD	44
HWS1500/HD	46
HWS1800T/HD	48
HWS/ME	51
Specifications	
HWS30/ME	52
HWS50/ME	54
HWS100/ME	56
HWS150/ME	58
HWS300/ME	60
HWS600/ME	62
HWS1000/ME	64
HWS1500/ME	66
HWS-P	69
Specifications	
HWS300P	70
HWS600P	72
HWS Series All	74
Block Diagram	
HWS15, 30, 50, 80, 100, 150	74
HWS300, 600, 1000	75
HWS1500, 1800T	76
Sequence Time Chart	
HWS300, 600, 1000	77
HWS1500, 1800T	78
Instruction Manual	
HWS15, 30, 50, 80, 100, 150	79
HWS300, 600	85
HWS1000	93
HWS1500	104
HWS1800T	113
HWS300P, 600P	124

HWS

Single Output 15W-1800W

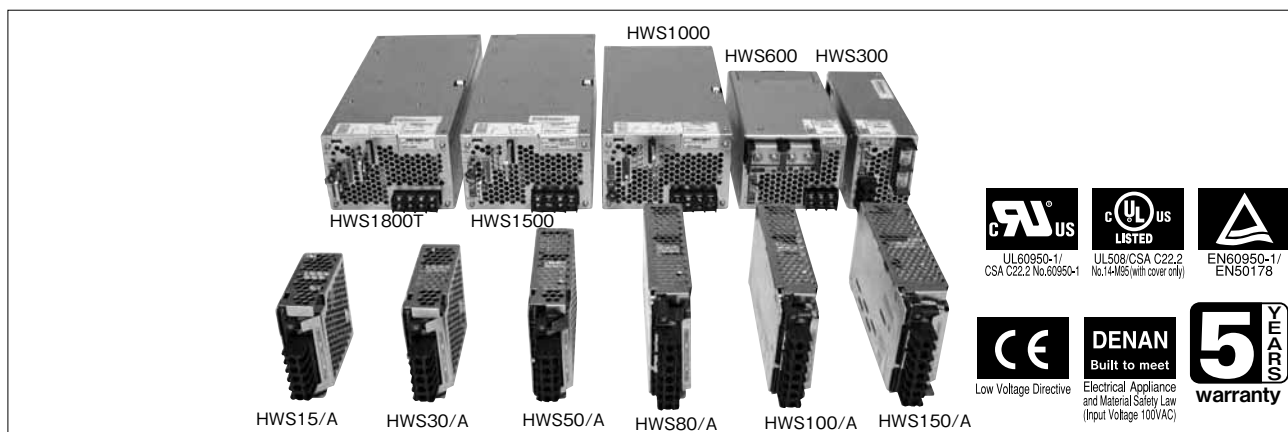

Features

- Environmentally-friendly: Conforming to RoHS directives. High-efficiency technology reduces power loss by heat generation. Fan stopping in power-off by external control reduces acoustic noise and saves energy.
- Easy to use: All models in the same height of 82mm. Mountable in 2U-height racks without dead space.
- Safety and reliability: "Safety terminal" covering current flowing part secures safety for users. "No screw-dropping" design prevents from losing screws during maintenance operation.
- HWS1500-48 achieves high efficiency as 90%. Synchronous rectifier circuit improved efficiency of low voltage models by over 10% (HWS150-5).

Applications

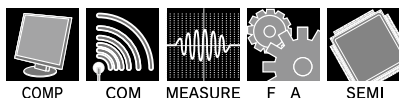

Model naming method

[HWS15-150]

HWS 50 - 5 / □ □

Series name Output power

- Blank: Without cover
 - A: With cover
 - R: Remote ON/OFF control (HWS15 & HWS30 excluded)
 - RA: Remote ON/OFF control, with cover (HWS15 & HWS30 excluded)
 - ADIN: DIN rail mountable (24Vout of 15-150W models with cover only)
 - Note: Requesting approval for safety standards should be made with HWS**-24/A.
- Nominal output voltage
ex. 3: 3.3V, 5: 5V, 48: 48V

[HWS300-1800]

HWS 300 - 5 / □ □

Series name Output power

- Blank: With cover, forced air cooling with built-in fan
 - PV: Output voltage adjustable by external voltage 12Vout+ models for HWS300, 600 only. (Supported by standard models for HWS1000 and above.)
- Nominal output voltage
ex. 3: 3.3V, 5: 5V, 48: 48V

Conformity to RoHS Directive

This means that, in conformity with EU Directive 2002/95/EC, lead, cadmium, mercury, hexavalent chromium, and specific bromine-based flame retardants, PBB and PBDE, have not been used, except for exempted applications.

Product Line up

Output Voltage	15W		30W		50W		80W		100W		150W	
	Output Current	Model	Output Current	Model	Output Current	Model	Output Current	Model	Output Current	Model	Output Current	Model
3.3V	3A	HWS15-3	6A	HWS30-3	10A	HWS50-3	16A	HWS80-3	20A	HWS100-3	30A	HWS150-3
5V	3A	HWS15-5	6A	HWS30-5	10A	HWS50-5	16A	HWS80-5	20A	HWS100-5	30A	HWS150-5
12V	1.3A	HWS15-12	2.5A	HWS30-12	4.3A	HWS50-12	6.7A	HWS80-12	8.5A	HWS100-12	13A	HWS150-12
15V	1A	HWS15-15	2A	HWS30-15	3.5A	HWS50-15	5.4A	HWS80-15	7A	HWS100-15	10A	HWS150-15
24V	0.65A	HWS15-24	1.3A	HWS30-24	2.2A	HWS50-24	3.4A	HWS80-24	4.5A	HWS100-24	6.5A	HWS150-24
48V	0.33A	HWS15-48	0.65A	HWS30-48	1.1A	HWS50-48	1.7A	HWS80-48	2.1A	HWS100-48	3.3A	HWS150-48

Output Voltage	300W		600W		1000W		1500W		1800W	
	Output Current (Peak)	Model	Output Current (Peak)	Model	Output Current (Peak)	Model	Output Current (Peak) (*)	Model	Output Current (Peak)	Model
3.3V	60A	HWS300-3	120A	HWS600-3	200A	HWS1000-3	300A/300A	HWS1500-3	300A	HWS1800T-3
5V	60A	HWS300-5	120A	HWS600-5	200A	HWS1000-5	300A/300A	HWS1500-5	300A	HWS1800T-5
6V	-	-	-	-	167A	HWS1000-6	250A/250A (300A)	HWS1500-6	250A (300A)	HWS1800T-6
7.5V	-	-	-	-	134A (160A)	HWS1000-7	200A/200A (240A)	HWS1500-7	200A (240A)	HWS1800T-7
12V	27A	HWS300-12	53A	HWS600-12	88A (100A)	HWS1000-12	125A/125A	HWS1500-12	125A (150A)	HWS1800T-12
15V	22A	HWS300-15	43A	HWS600-15	70A (80A)	HWS1000-15	100A/100A	HWS1500-15	100A (120A)	HWS1800T-15
24V	14A (16.5A)	HWS300-24	27A (31A)	HWS600-24	46A (58.5A)	HWS1000-24	65A/70A (105A)	HWS1500-24	75A (105A)	HWS1800T-24
36V	-	-	-	-	30.7A (39A)	HWS1000-36	42A/46.5A (70A)	HWS1500-36	50A (70A)	HWS1800T-36
48V	7A	HWS300-48	13A	HWS600-48	23A (29.2A)	HWS1000-48	32A/32A	HWS1500-48	37.5A (52.5A)	HWS1800T-48
60V	-	-	-	-	18.4A (23.4A)	HWS1000-60	25.6A/28A (42A)	HWS1500-60	30A (42A)	HWS1800T-60

* All specifications are subject to change without notice.

(*) (100Vin / 200Vin)

HWS15 Specifications (Read instruction manual carefully, before using the power supply unit.)

ITEMS/UNITS		MODEL	HWS15-3	HWS15-5	HWS15-12	HWS15-15	HWS15-24	HWS15-48	
Input	Voltage Range (*2)	V	AC85 - 265 or DC120 - 370						
	Frequency (*2)	Hz	47 - 63						
	Efficiency (100/200VAC)(typ) (*1)	%	68 / 71	77 / 79	80 / 81		82 / 83	80 / 80	
	Current (100/200VAC)(typ) (*1)	A	0.3 / 0.15	0.4 / 0.2					
	Inrush Current (100/200VAC)(typ) (*3)	A	14 / 28, Ta=25°C, cold start						
	Leakage Current (*10)	mA	Less than 0.5. (0.2 (typ) at 100VAC / 0.4 (typ) at 230VAC)						
Output	Nominal Voltage	VDC	3.3	5	12	15	24	48	
	Maximum Current	A	3		1.3	1	0.65	0.33	
	Maximum Power	W	10	15	15.6	15	15.6	15.8	
	Maximum Line Regulation (*5)	mV	20		48	60	96	192	
	Maximum Load Regulation (*6)	mV	40		96	120	192	384	
	Temperature Coefficient		Less than 0.02% / °C						
	Maximum Ripple & Noise (0<Ta<70°C) (*4)	mVp-p	120		150		200		
	Maximum Ripple & Noise (-10<Ta<0°C) (*4)	mVp-p	160		180		240		
	Hold-up Time (typ) (*9)	ms	20						
	Voltage Adjustable Range	VDC	2.97 - 3.96	4.0 - 6.0	9.6 - 14.4	12.0 - 18.0	19.2 - 28.8	38.4 - 52.8	
Function	Over Current Protection (*7)	A	>3.15		>1.36	>1.05	>0.68	>0.34	
	Over Voltage Protection (*8)	VDC	4.13 - 4.95	6.25 - 7.25	15.0 - 17.4	18.8 - 21.8	30.0 - 34.8	55.2 - 64.8	
	Remote Sensing		-						
	Remote ON/OFF Control		-						
	Parallel Operation		-						
	Series Operation		Possible						
	Line DIP		Built to meet SEMI-F47 (200VAC Line only)						
	Operating Temperature (*11)	°C	-10 to +70 (-10 to +50: 100%, +60: 60%, +70: 20%)						
Environment	Storage Temperature	°C	-30 to +85						
	Operating Humidity	%RH	30 - 90 (No dewdrop)						
	Storage Humidity	%RH	10 - 95 (No dewdrop)						
	Vibration		At no operating, 10 - 55Hz (sweep for 1min) 19.6m/s ² constant, X, Y, Z 1hour each.						
	Shock (In package)		Less than 196.1m/s ²						
	Cooling		Convection cooling						
	Isolation	Withstand Voltage		Input - FG : 2kVAC (20mA), Input - Output : 3kVAC (20mA) Output - FG : 500VAC (100mA) for 1min					
Isolation Resistance			More than 100MΩ at 25°C and 70%RH Output - FG : 500VDC						
Standards	Safety Standards (*12)		Approved by UL60950-1, CSA C22.2 No.60950-1, EN60950-1, EN50178 UL508 (with cover models only), CSA C22.2 No.14-M95 (with cover models only) Built to meet UL508, DENAN						
	PFHC		Built to meet IEC61000-3-2						
	EMI		Built to meet EN55011/EN55022-B, FCC-B, VCCI-B						
	Immunity		Built to meet IEC61000-4-2(Level 2,3), -3(Level 3), -4(Level 3), -5(Level 3,4), -6(Level 3), -8(Level 4), -11						
Mechanical	Weight (typ)	g	180						
	Size (W x H x D)	mm	26.5 x 82 x 80 (Refer to outline drawing)						

(*1) At 100/200VAC, Ta=25°C and maximum output power.

(*2) For cases where conformance to various safety specs (UL, CSA, EN) are required, to be described as 100 - 240VAC (50/60Hz).

(*3) Not applicable for the in-rush current to noise filter for less than 0.2ms.

(*4) Measure with JEITA RC-9131A probe, bandwidth of scope :100MHz.

For start up at low ambient temperature and low input voltage, output ripple noise might not meet specification. However, there is no overshoot at start up and output ripple noise specification can be met after one second.

(*5) 85 - 265VAC, constant load.

(*6) No load-Full load, constant input voltage.

(*7) Foldback current limit with automatic recovery. Not operate at over load or dead short condition for more than 30 seconds.

(*8) OVP circuit will shutdown output, manual reset (Re power on).

(*9) At 100/200VAC, Ta=25°C, nominal output voltage and maximum output current.

(*10) Measured by the each measuring method of UL, CSA, EN and DENAN (at 60Hz).

(*11) Ratings - Derating at standard mounting.
- Load (%) is percent of maximum output power or maximum output current, whichever is greater.
- As for other mountings, refer to derating curve.

(*12) As for DENAN, built to meet at 100VAC.

● Recommended EMC Filter

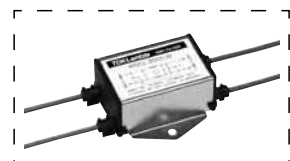

RSEL-2001W
Please refer to "TDK-Lambda EMC Filters" catalog.

Outline Drawing

[HWS15]

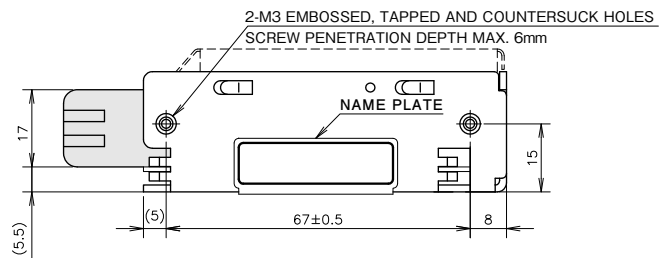
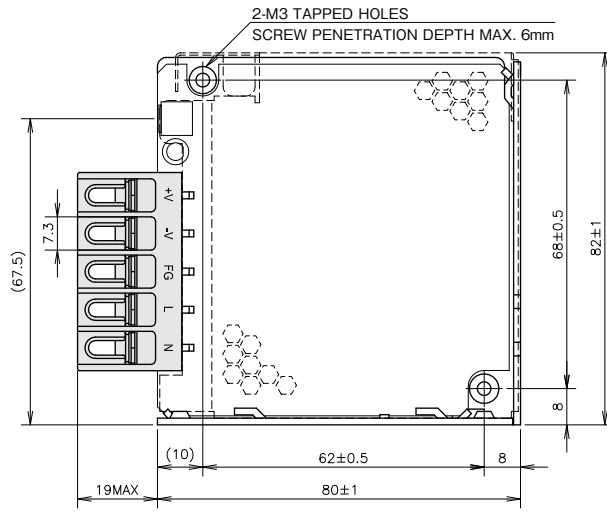
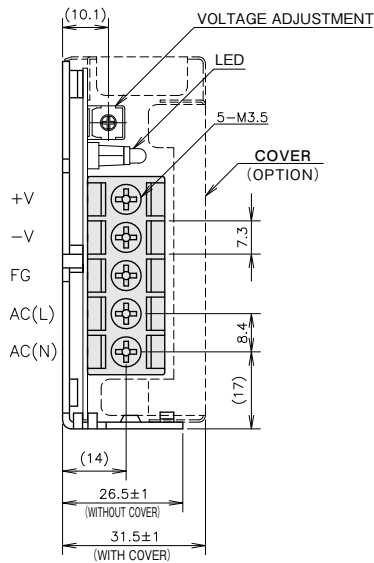

unit: mm

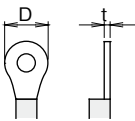

Recommended Solderless Terminal		
D (max)	t (max)	Qty (max)
6.8mm	0.8mm	2 pcs

Output Derating

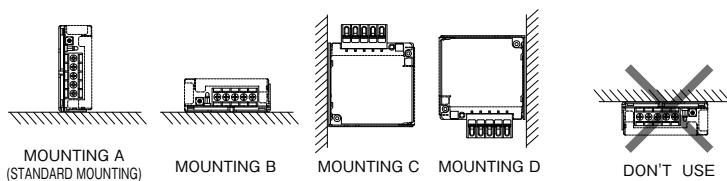
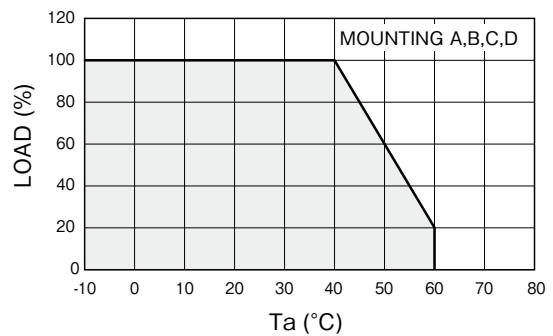
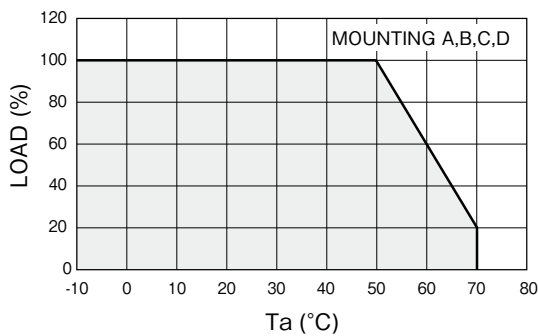

HWS30 Specifications (Read instruction manual carefully, before using the power supply unit.)

ITEMS/UNITS		MODEL	HWS30-3	HWS30-5	HWS30-12	HWS30-15	HWS30-24	HWS30-48	
Input	Voltage Range (*2)	V	AC85 - 265 or DC120 - 370						
	Frequency (*2)	Hz	47 - 63						
	Efficiency (100/200VAC)(typ) (*1)	%	70 / 73	77 / 80	81 / 83		83 / 86	82 / 83	
	Current (100/200VAC)(typ) (*1)	A	0.6 / 0.3	0.8 / 0.4					
	Inrush Current (100/200VAC)(typ)(*3)	A	14 / 28, Ta=25°C, cold start						
	Leakage Current (*10)	mA	Less than 0.5. (0.2 (typ) at 100VAC / 0.4 (typ) at 230VAC)						
Output	Nominal Voltage	VDC	3.3	5	12	15	24	48	
	Maximum Current	A	6		2.5	2	1.3	0.65	
	Maximum Power	W	20		30		31.2		
	Maximum Line Regulation (*5)	mV	20		48	60	96	192	
	Maximum Load Regulation (*6)	mV	40		96	120	192	384	
	Temperature Coefficient		Less than 0.02% / °C						
	Maximum Ripple & Noise (0≤Ta≤70°C) (*4)	mVp-p	120		150		200		
	Maximum Ripple & Noise (-10≤Ta< 0°C) (*4)	mVp-p	160		180		240		
	Hold-up Time (typ) (*9)	ms	20						
	Voltage Adjustable Range	VDC	2.97 - 3.96	4.0 - 6.0	9.6 - 14.4	12.0 - 18.0	19.2 - 28.8	38.4 - 52.8	
Function	Over Current Protection (*7)	A	>6.3		>2.62	>2.1	>1.36	>0.68	
	Over Voltage Protection (*8)	VDC	4.13 - 4.95	6.25 - 7.25	15.0 - 17.4	18.8 - 21.8	30.0 - 34.8	55.2 - 64.8	
	Remote Sensing		-						
	Remote ON/OFF Control		-						
	Parallel Operation		-						
	Series Operation		Possible						
	Line DIP		Built to meet SEMI-F47 (200VAC Line only)						
	Operating Temperature (*11)	°C	-10 to +70 (-10 to +50: 100%, +60: 60%, +70: 20%)						
	Storage Temperature	°C	-30 to +85						
	Operating Humidity	%RH	30 - 90 (No dewdrop)						
Environment	Storage Humidity	%RH	10 - 95 (No dewdrop)						
	Vibration		At no operating, 10 - 55Hz (sweep for 1min) 19.6m/s ² constant, X, Y, Z 1hour each.						
	Shock (In package)		Less than 196.1m/s ²						
	Cooling		Convection cooling						
	Isolation	Withstand Voltage		Input - FG : 2kVAC (20mA), Input - Output : 3kVAC (20mA) Output - FG : 500VAC (100mA) for 1min					
Isolation Resistance			More than 100MΩ at 25°C and 70%RH Output - FG : 500VDC						
Standards	Safety Standards (*12)		Approved by UL60950-1, CSA C22.2 No.60950-1, EN60950-1, EN50178 UL508 (with cover models only), CSA C22.2 No.14-M95 (with cover models only) Built to meet DENAN						
	PFHC		Built to meet IEC61000-3-2						
	EMI		Built to meet EN55011/EN55022-B, FCC-B, VCCI-B						
	Immunity		Built to meet IEC61000-4-2(Level 2,3), -3(Level 3), -4(Level 3), -5(Level 3,4), -6(Level 3), -8(Level 4), -11						
Mechanical	Weight (typ)	g	220						
	Size (W x H x D)	mm	26.5 x 82 x 95 (Refer to outline drawing)						

(*1) At 100/200VAC, Ta=25°C and maximum output power.

(*2) For cases where conformance to various safety specs (UL, CSA, EN) are required, to be described as 100 - 240VAC (50/60Hz).

(*3) Not applicable for the in-rush current to noise filter for less than 0.2ms.

(*4) Measure with JEITA RC-9131A probe, bandwidth of scope :100MHz.

For start up at low ambient temperature and low input voltage, output ripple noise might not meet specification. However, there is no overshoot at start up and output ripple noise specification can be met after one second.

(*5) 85 - 265VAC, constant load.

(*6) No load-Full load, constant input voltage.

(*7) Foldback current limit with automatic recovery. Not operate at over load or dead short condition for more than 30 seconds.

(*8) OVP circuit will shutdown output, manual reset (re power on).

(*9) At 100/200VAC, Ta=25°C, nominal output voltage and maximum output current.

(*10) Measured by the each measuring method of UL, CSA, EN and DENAN (at 60Hz).

(*11) Ratings - Derating at standard mounting.

- Load (%) is percent of maximum output power or maximum output current, whichever is greater.
- As for other mountings, refer to derating curve.

(*12) As for DENAN, built to meet at 100VAC.

● Recommended EMC Filter

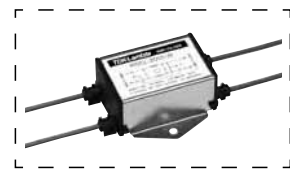

RSEL-2001W

Please refer to "TDK-Lambda EMC Filters" catalog.

HWS

HWS HD

HWS ME

HWS-P

Instruction Manual

Outline Drawing

[HWS30]

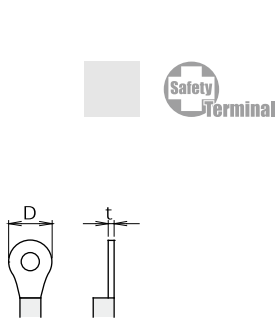
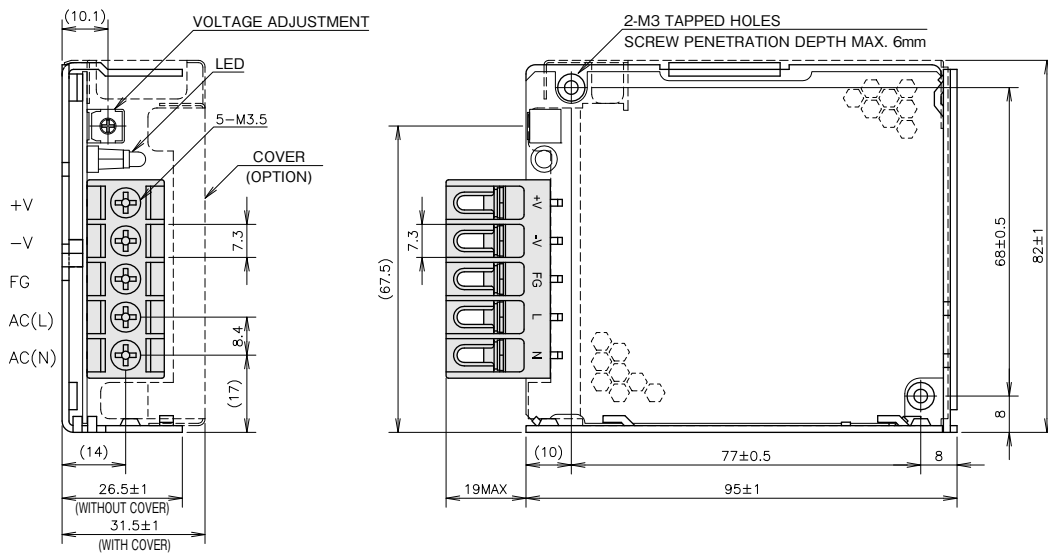

Recommended Solderless Terminal		
D (max)	t (max)	Qty (max)
6.8mm	0.8mm	2 pcs

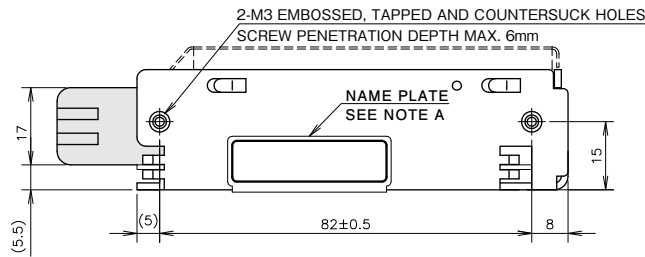

unit: mm

Output Derating

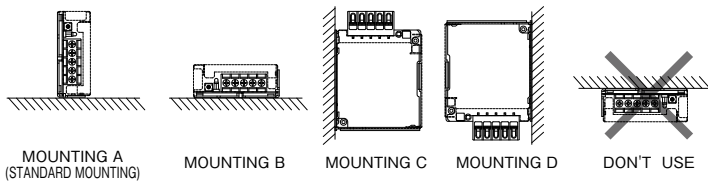
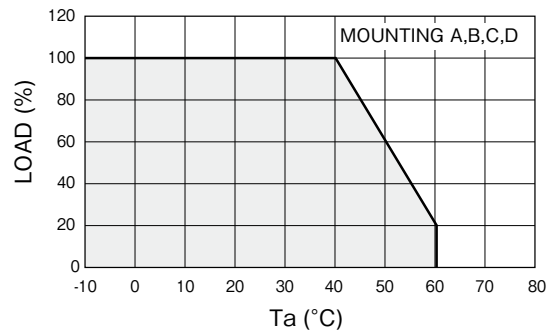
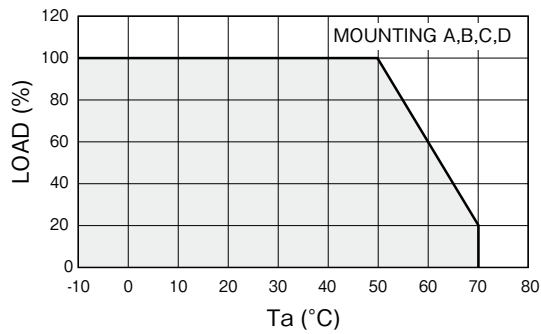

HWS50 Specifications (Read instruction manual carefully, before using the power supply unit.)

ITEMS/UNITS		MODEL	HWS50-3	HWS50-5	HWS50-12	HWS50-15	HWS50-24	HWS50-48
Input	Voltage Range (*2)	V	AC85 - 265 or DC120 - 370					
	Frequency (*2)	Hz	47 - 63					
	Power Factor (100/200VAC)(typ) (*1)		0.98 / 0.90		0.99 / 0.95			
	Efficiency (100/200VAC)(typ) (*1)	%	76 / 78	82 / 84	81 / 83		82 / 84	83 / 85
	Current (100/200VAC)(typ) (*1)	A	0.5 / 0.25		0.7 / 0.35			
	Inrush Current (100/200VAC)(typ) (*3)	A	14 / 28, Ta=25°C, cold start					
Leakage Current (*10)	mA	Less than 0.5. (0.2 (typ) at 100VAC / 0.4 (typ) at 230VAC)						
Output	Nominal Voltage	V	3.3	5	12	15	24	48
	Maximum Current	A	10					
	Maximum Power	W	33	50	51.6	52.5	52.8	
	Maximum Line Regulation (*5)	mV	20		48	60	96	192
	Maximum Load Regulation (*6)	mV	40		96	120	192	384
	Temperature Coefficient		Less than 0.02% /°C					
	Maximum Ripple & Noise (0≤Ta≤70°C) (*4)	mVp-p	120		150		200	
	Maximum Ripple & Noise (-10≤Ta< 0°C) (*4)	mVp-p	160		180		240	
	Hold-up Time (typ) (*9)	ms	20					
	Voltage Adjustable Range	VDC	2.97 - 3.96	4.0 - 6.0	9.6 - 14.4	12.0 - 18.0	19.2 - 28.8	38.4 - 52.8
Function	Over Current Protection (*7)	A	>10.5		>4.51	>3.67	>2.31	>1.15
	Over Voltage Protection (*8)	V	4.13 - 4.95	6.25 - 7.25	15.0 - 17.4	18.8 - 21.8	30.0 - 34.8	55.2 - 64.8
	Remote Sensing		-					
	Remote ON/OFF Control		Possible (/R Option)					
	Parallel Operation		-					
	Series Operation		Possible					
	Line DIP		Built to meet SEMI-F47 (200VAC Line only)					
Environment	Operating Temperature (*11)	°C	-10 to +70 (-10 to +50: 100%, +60: 60%, +70: 20%)					
	Storage Temperature	°C	-30 to +85					
	Operating Humidity	%RH	30 - 90 (No dewdrop)					
	Storage Humidity	%RH	10 - 95 (No dewdrop)					
	Vibration		At no operating, 10 - 55Hz (sweep for 1min) 19.6m/s ² constant, X, Y, Z 1hour each.					
	Shock (In package)		Less than 196.1m/s ²					
Isolation	Cooling		Convection cooling					
	Withstand Voltage		Input - FG : 2kVAC (20mA), Input - Output : 3kVAC (20mA) Output - FG : 500VAC (100mA) for 1min					
	Isolation Resistance		More than 100MΩ at 25°C and 70%RH Output - FG : 500VDC					
Standards	Safety Standards (*12)		Approved by UL60950-1, CSA C22.2 No.60950-1, EN60950-1, EN50178 UL508 (with cover models only), CSA C22.2 No.14-M95 (with cover models only) Built to meet DENAN					
	PFHC		Built to meet IEC61000-3-2					
	EMI		Built to meet EN55011/EN55022-B, FCC-B, VCCI-B					
	Immunity		Built to meet IEC61000-4-2(Level 2,3), -3(Level 3), -4(Level 3), -5(Level 3,4), -6(Level 3), -8(Level 4), -11					
Mechanical	Weight (typ)	g	280					
	Size (W x H x D)	mm	26.5 x 82 x 120 (Refer to outline drawing)					

(*1) At 100/200VAC, Ta=25°C and maximum output power.

(*2) For cases where conformance to various safety specs (UL, CSA, EN) are required, to be described as 100 - 240VAC (50/60Hz).

(*3) Not applicable for the in-rush current to noise filter for less than 0.2ms.

(*4) Measure with JEITA RC-9131A probe, bandwidth of scope : 100MHz.

(*5) 85 - 265VAC, constant load.

(*6) No load-full load, constant input voltage.

(*7) Constant current limit and hiccup with automatic recovery. Not operate at over load or dead short condition for more than 30 seconds.

(*8) OVP circuit will shutdown output, manual reset (re power on).

(*9) At 100/200VAC, nominal output voltage and maximum output current.

(*10) Measured by the each measuring method of UL, CSA, EN and DENAN (at 60Hz).

(*11) Ratings - Derating at standard mounting.

- Load (%) is percent of maximum output power or maximum output current, whichever is greater.

- As for other mountings, refer to derating curve.

(*12) As for DENAN, built to meet at 100VAC.

● Recommended EMC Filter



RSEL-2001W

Please refer to "TDK-Lambda EMC Filters" catalog.

HWS

HWS HD

HWS ME

HWS-P

Instruction Manual

Outline Drawing

[HWS50]

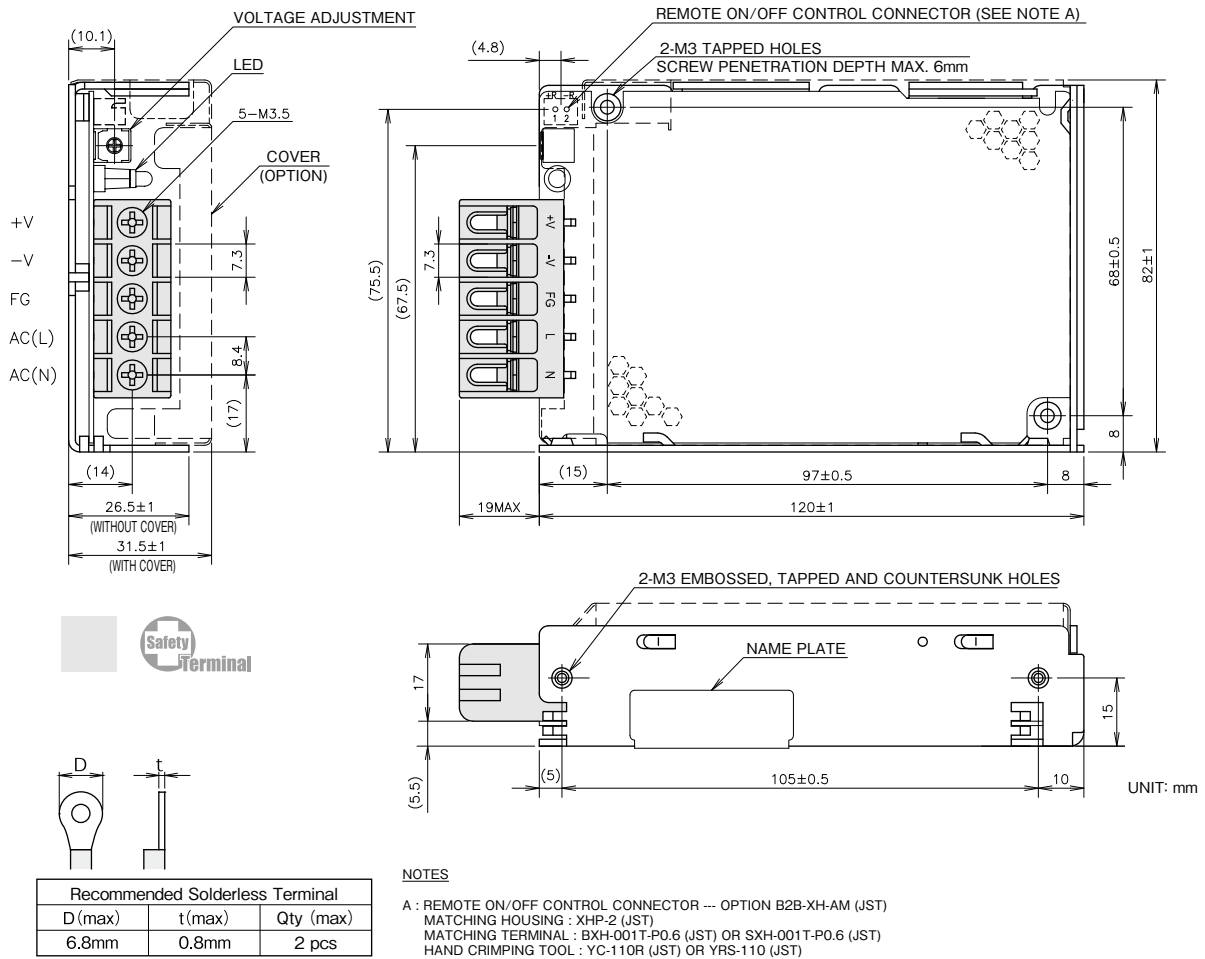

Output Derating

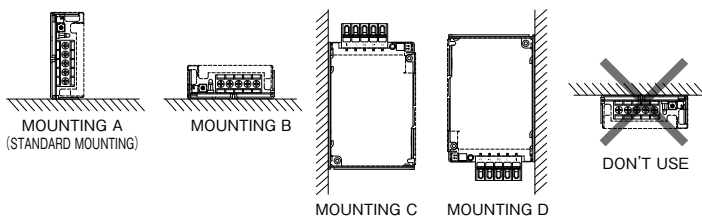
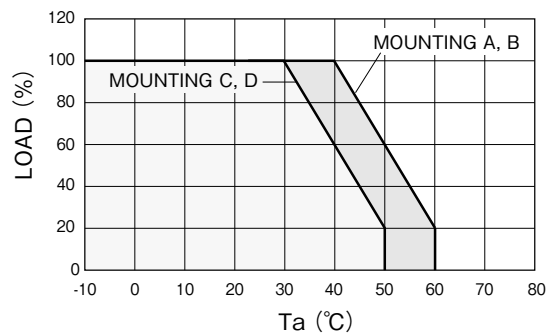
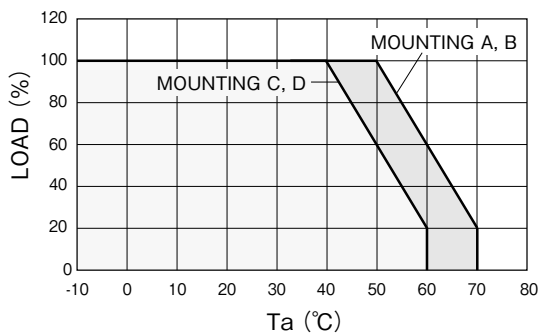

HWS80 Specifications (Read instruction manual carefully, before using the power supply unit.)

ITEMS/UNITS		MODEL	HWS80-3	HWS80-5	HWS80-12	HWS80-15	HWS80-24	HWS80-48
Input	Voltage Range (*2)	V	AC85 - 265 or DC120 - 370					
	Frequency (*2)	Hz	47 - 63					
	Power Factor (100/200VAC)(typ) (*1)		0.98 / 0.90		0.99 / 0.95			
	Efficiency (100/200VAC)(typ) (*1)	%	77 / 79		82 / 85		83 / 85	84 / 86
	Current (100/200VAC)(typ) (*1)	A	0.72 / 0.36		1.04 / 0.52			
	Inrush Current (100/200VAC)(typ) (*3)	A	14 / 28, Ta=25°C, cold start					
Leakage Current (*10)	mA	Less than 0.5. (0.2 (typ) at 100VAC / 0.4 (typ) at 230VAC)						
Output	Nominal Voltage	VDC	3.3	5	12	15	24	48
	Maximum Current	A	16					
	Maximum Power	W	52.8	80	80.4	81	81.6	
	Maximum Line Regulation (*5)	mV	20		48	60	96	192
	Maximum Load Regulation (*6)	mV	40		96	120	192	384
	Temperature Coefficient		Less than 0.02% / °C					
	Maximum Ripple & Noise (0≤Ta≤70°C) (*4)	mVp-p	120		150		200	
	Maximum Ripple & Noise (-10≤Ta<0°C) (*4)	mVp-p	160		180		240	
	Hold-up Time (typ) (*9)	ms	20ms					
	Voltage Adjustable Range	VDC	2.97 - 3.96	4.0 - 6.0	9.6 - 14.4	12.0 - 18.0	19.2 - 28.8	38.4 - 52.8
Function	Over Current Protection (*7)	A	>16.8		>7.04	>5.67	>3.57	>1.79
	Over Voltage Protection (*8)	VDC	4.13 - 4.95	6.25 - 7.25	15.0 - 17.4	18.8 - 21.8	30.0 - 34.8	55.2 - 64.8
	Remote Sensing		Possible					
	Remote ON/OFF Control		Possible (/R Option)					
	Parallel Operation		-					
	Series Operation		Possible					
Environment	Line DIP		Built to meet SEMI-F47 (200VAC Line only)					
	Operating Temperature (*11)	°C	-10 to +70 (-10 to +50: 100%, +60: 60%, +70: 20%)					
	Storage Temperature	°C	-30 to +85					
	Operating Humidity	%RH	30 - 90 (No dewdrop)					
	Storage Humidity	%RH	10 - 95 (No dewdrop)					
	Vibration		At no operating, 10 - 55Hz (sweep for 1min) 19.6m/s² constant, X, Y, Z 1hour each.					
Isolation	Shock (In package)		Less than 196.1m/s²					
	Cooling		Convection cooling					
	Withstand Voltage		Input - FG : 2kVAC (20mA), Input - Output : 3kVAC (20mA) Output - FG : 500VAC (100mA) for 1min					
Standards	Isolation Resistance		More than 100MΩ at 25°C and 70%RH Output - FG : 500VDC					
	Safety Standards (*12)		Approved by UL60950-1, CSA C22.2 No.60950-1, EN60950-1, EN50178 UL508 (with cover models only), CSA C22.2 No.14-M95 (with cover models only) Built to meet DENAN					
	PFHC		Built to meet IEC61000-3-2					
	EMI		Built to meet EN55011/EN55022-B, FCC-B, VCCI-B					
Mechanical	Immunity		Built to meet IEC61000-4-2(Level 2,3), -3(Level 3), -4(Level 3), -5(Level 3,4), -6(Level 3), -8(Level 4), -11					
	Weight (typ)	g	450					
	Size (W x H x D)	mm	28 x 82 x 160 (Refer to outline drawing)					

- (*1) At 100/200VAC, Ta=25°C and maximum output power.
- (*2) For cases where conformance to various safety specs (UL, CSA, EN) are required, to be described as 100 - 240VAC (50/60Hz).
- (*3) Not applicable for the in-rush current to noise filter for less than 0.2ms.
- (*4) Measure with JEITA RC-9131A probe, bandwidth of scope : 100MHz.
- (*5) 85 - 265VAC , constant load.
- (*6) No load-full load, constant input voltage.
- (*7) Constant current limit and hiccup with automatic recovery. Not operate at over load or dead short condition for more than 30 seconds.
- (*8) OVP circuit will shutdown output, manual reset (re power on).
- (*9) At 100/200VAC, nominal output voltage and maximum output current.
- (*10) Measured by the each measuring method of UL, CSA, EN and DENAN (at 60Hz).
- (*11) Ratings - Derating at standard mounting.
- Load (%) is percent of maximum output power or maximum output current, whichever is greater.
- As for other mountings, refer to derating curve.
- (*12) As for DENAN, built to meet at 100VAC.

● Recommended EMC Filter



RSEL-2002W
Please refer to "TDK-Lambda EMC Filters" catalog.

Outline Drawing

[HWS80]

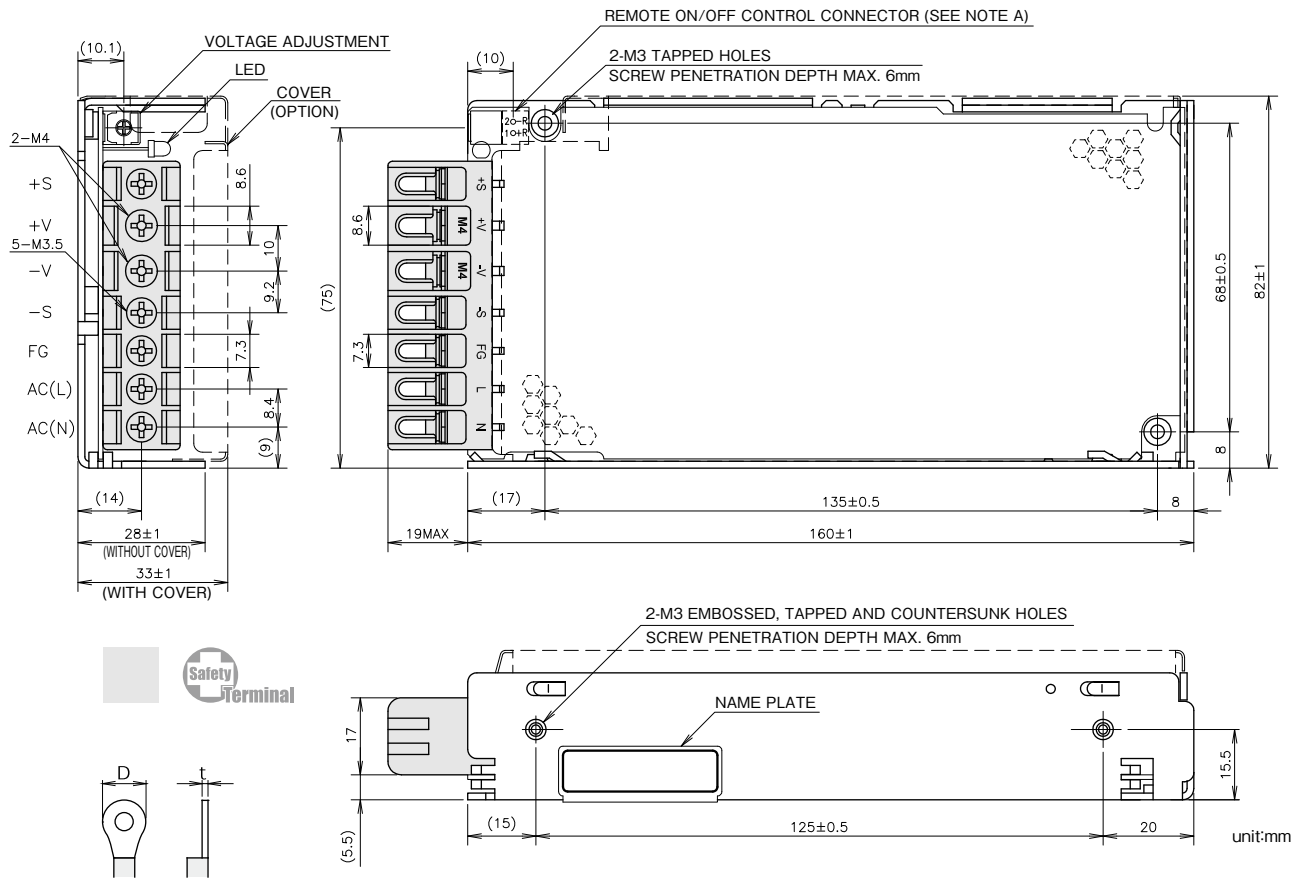

Terminal	Recommended Solderless Terminal		
	D (max)	t (max)	Qty (max)
+V / -V	8.1mm	0.8mm	2 pcs
		1.0mm	1 pc
Others	6.8mm	0.8mm	2 pcs

NOTES

- A : REMOTE ON/OFF CONTROL CONNECTOR --- OPTION B2B-XH-AM (JST)
- MATCHING HOUSING : XHP-2 (JST)
- MATCHING TERMINAL : BXH-001T-P0.6 (JST) OR SXH-001T-P0.6 (JST)
- HAND CRIMPING TOOL : YC-110R (JST) OR YRS-110 (JST)

ACCESSORIES

* SHORT PIECE (NET 2) FOR SHORTING PURPOSE
(*S to +V, -S to -V): MOUNTED AT TIME OF SHIPMENT.

Output Derating

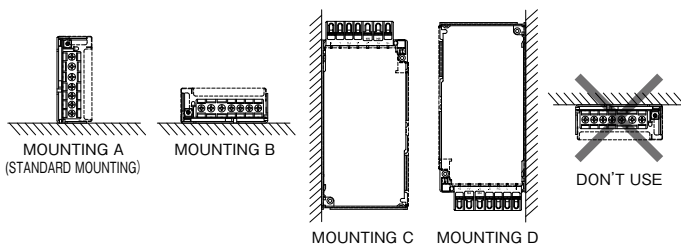
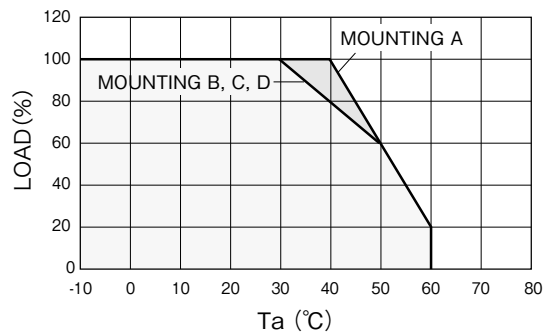
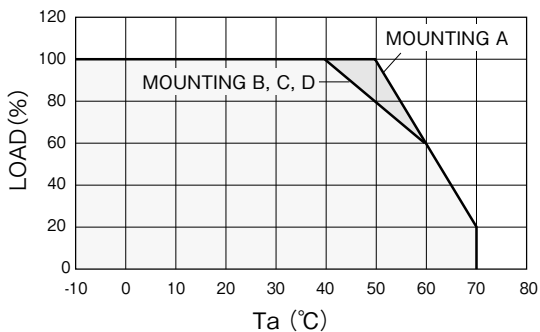

HWS100 Specifications (Read instruction manual carefully, before using the power supply unit.)

ITEMS/UNITS		MODEL	HWS100-3	HWS100-5	HWS100-12	HWS100-15	HWS100-24	HWS100-48
Input	Voltage Range (*2)	V	AC85 - 265 or DC120 - 370					
	Frequency (*2)	Hz	47 - 63					
	Power Factor (100/200VAC)(typ) (*1)		0.98 / 0.90		0.99 / 0.95			
	Efficiency (100/200VAC)(typ) (*1)	%	78 / 81		83 / 86		84 / 87	
	Current (100/200VAC)(typ) (*1)	A	0.9 / 0.45		1.3 / 0.65			
	Inrush Current (100/200VAC)(typ) (*3)	A	14 / 28, Ta=25°C, cold start					
Leakage Current (*10)	mA	Less than 0.5. (0.2 (typ) at 100VAC / 0.4 (typ) at 230VAC)						
Output	Nominal Voltage	VDC	3.3	5	12	15	24	48
	Maximum Current	A	20		8.5	7	4.5	2.1
	Maximum Power	W	66	100	102	105	108	100.8
	Maximum Line Regulation (*5)	mV	20		48	60	96	192
	Maximum Load Regulation (*6)	mV	40		96	120	192	384
	Temperature Coefficient		Less than 0.02% / °C					
	Maximum Ripple & Noise (0≤Ta≤70°C)(*4)	mVp-p	120		150		200	
	Maximum Ripple & Noise (-10≤Ta< 0°C)(*4)	mVp-p	160		180		240	
	Hold-up Time (typ) (*9)	ms	20					
	Voltage Adjustable Range	VDC	2.97 - 3.96	4.0 - 6.0	9.6 - 14.4	12.0 - 18.0	19.2 - 28.8	38.4 - 52.8
Function	Over Current Protection (*7)	A	>21.0		>8.92	>7.35	>4.72	>2.20
	Over Voltage Protection (*8)	VDC	4.13 - 4.95	6.25 - 7.25	15.0 - 17.4	18.8 - 21.8	30.0 - 34.8	55.2 - 64.8
	Remote Sensing		Possible					
	Remote ON/OFF Control		Possible (/R Option)					
	Parallel Operation		-					
	Series Operation		Possible					
Environment	Line DIP		Built to meet SEMI-F47 (200VAC Line only)					
	Operating Temperature (*11)	°C	-10 to +70 (-10 to +50: 100%, +60: 60%, +70: 20%)					
	Storage Temperature	°C	-30 to +85					
	Operating Humidity	%RH	30 - 90 (No dewdrop)					
	Storage Humidity	%RH	10 - 95 (No dewdrop)					
	Vibration		At no operating, 10 - 55Hz (sweep for 1min) 19.6m/s ² constant, X, Y, Z 1hour each.					
Isolation	Shock (In package)		Less than 196.1m/s ²					
	Cooling		Convection cooling					
	Withstand Voltage		Input - FG : 2kVAC (20mA), Input - Output : 3kVAC (20mA) Output - FG : 500VAC (100mA) for 1min					
	Isolation Resistance		More than 100MΩ at 25°C and 70%RH Output - FG : 500VDC					
Standards	Safety Standards (*12)		Approved by UL60950-1, CSA C22.2 No.60950-1, EN60950-1, EN50178 UL508 (with cover models only), CSA C22.2 No.14-M95 (with cover models only) Built to meet, DENAN					
	PFHC		Built to meet IEC61000-3-2					
	EMI		Built to meet EN55011/EN55022-B, FCC-B, VCCI-B					
Mechanical	Immunity		Built to meet IEC61000-4-2(Level 2,3), -3(Level 3), -4(Level 3), -5(Level 3,4), -6(Level 3), -8(Level 4), -11					
	Weight (typ)	g	450					
	Size (W x H x D)	mm	28 x 82 x 160 (Refer to outline drawing)					

- (*1) At 100/200VAC, Ta=25°C and maximum output power.
- (*2) For cases where conformance to various safety specs (UL, CSA, EN) are required, to be described as 100 - 240VAC (50/60Hz).
- (*3) Not applicable for the in-rush current to noise filter for less than 0.2ms.
- (*4) Measure with JEITA RC-9131A probe, bandwidth of scope :100MHz.
- (*5) 85 - 265VAC, constant load.
- (*6) No load-Full load, constant input voltage.
- (*7) Constant current limit and hiccup with automatic recovery.
Not operate at over load or dead short condition for more than 30 seconds.
- (*8) OVP circuit will shutdown output, manual reset (re power on).
- (*9) At 100/200VAC, nominal output voltage and maximum output current.
- (*10) Measured by the each measuring method of UL, CSA, EN and DENAN (at 60Hz).
- (*11) Ratings - Derating at standard mounting.
- Load (%) is percent of maximum output power or maximum output current, whichever is greater.
- As for other mountings, refer to derating curve
- (*12) As for DENAN, built to meet at 100VAC.

● Recommended EMC Filter



RSEL-2002W

Please refer to "TDK-Lambda EMC Filters" catalog.

HWS

HWS HD

HWS ME

HWS-P

Instruction Manual

Outline Drawing

[HWS100]

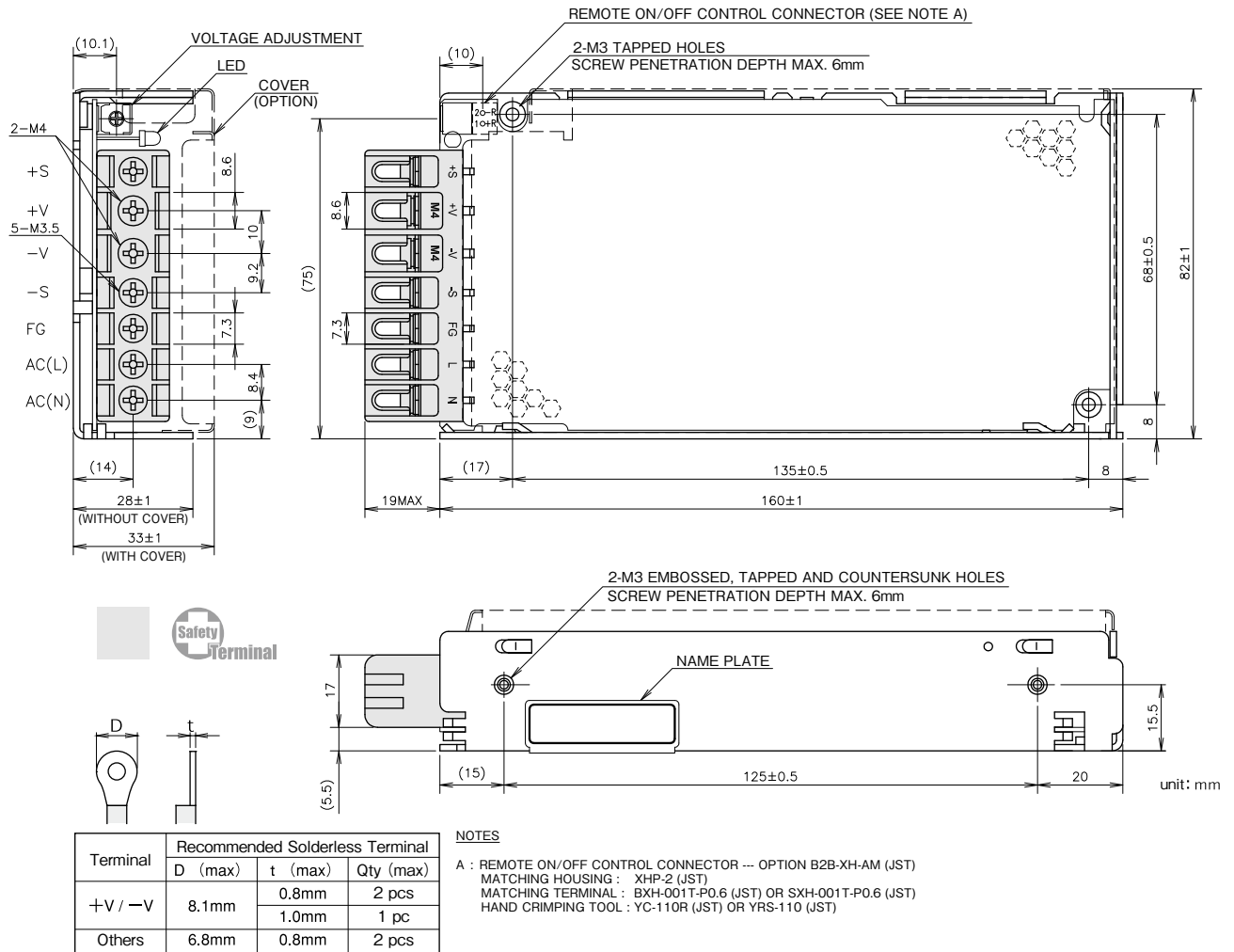

ACCESSORIES

* SHORT PIECE (NET 2) FOR SHORTING PURPOSE
 (+S to +V, -S to -V): MOUNTED AT TIME OF SHIPMENT.

Output Derating

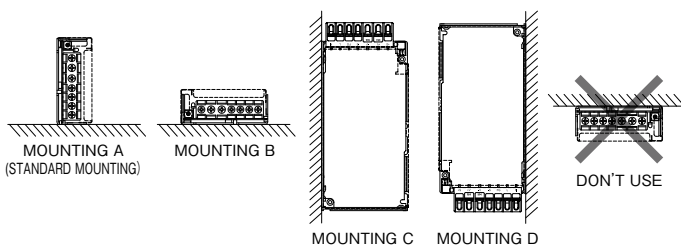
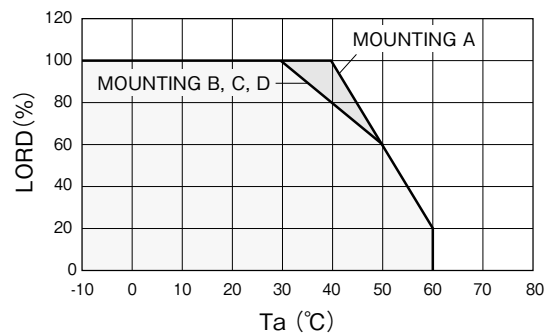
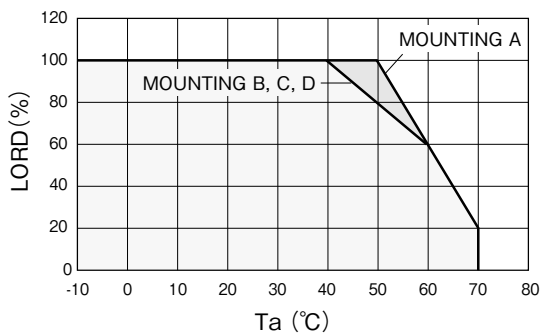

HWS150 Specifications (Read instruction manual carefully, before using the power supply unit.)

ITEMS/UNITS		MODEL	HWS150-3	HWS150-5	HWS150-12	HWS150-15	HWS150-24	HWS150-48
Input	Voltage Range (*2)	V	AC85 - 265 or DC120 - 370					
	Frequency (*2)	Hz	47 - 63					
	Power Factor (100/200VAC)(typ) (*1)		0.98 / 0.90		0.99 / 0.95			
	Efficiency (100/200VAC)(typ) (*1)	%	78 / 81		83 / 86		85 / 88	
	Current (100/200VAC)(typ) (*1)	A	1.3 / 0.65		1.9 / 0.95			
	Inrush Current (100/200VAC)(typ) (*3)	A	14 / 28, Ta=25°C, cold start					
	Leakage Current (*10)	mA	Less than 0.5. (0.2 (typ) at 100VAC / 0.4 (typ) at 230VAC)					
Output	Nominal Voltage	V	3.3	5	12	15	24	48
	Maximum Current	A	30		13	10	6.5	3.3
	Maximum Power	W	99	150	156	150	156	158.4
	Maximum Line Regulation (*5)	mV	20		48	60	96	192
	Maximum Load Regulation (*6)	mV	40		96	120	192	384
	Temperature Coefficient		Less than 0.02% / °C					
	Maximum Ripple & Noise (0≤Ta≤70°C) (*4)	mVp-p	120		150		200	
	Maximum Ripple & Noise (-10≤Ta<0°C) (*4)	mVp-p	160		180		240	
	Hold-up Time (typ) (*9)	ms	20					
	Voltage Adjustable Range	VDC	2.97 - 3.96	4.0 - 6.0	9.6 - 14.4	12.0 - 18.0	19.2 - 28.8	38.4 - 52.8
Function	Over Current Protection (*7)	A	>31.5		>13.6	>10.5	>6.82	>3.46
	Over Voltage Protection (*8)	V	4.13 - 4.95	6.25 - 7.25	15.0 - 17.4	18.8 - 21.8	30.0 - 34.8	55.2 - 64.8
	Remote Sensing (*8)		Possible					
	Remote ON/OFF Control		Possible (/R Option)					
	Parallel Operation		-					
	Series Operation		Possible					
	Line DIP		Built to meet SEMI-F47 (200VAC Line only)					
Environment	Operating Temperature (*11)	°C	-10 to +70 (-10 to +50: 100%, +60: 60%, +70: 20%)					
	Storage Temperature	°C	-30 to +85					
	Operating Humidity	%RH	30 - 90 (No dewdrop)					
	Storage Humidity	%RH	10 - 95 (No dewdrop)					
	Vibration		At no operating, 10 - 55Hz (sweep for 1min) 19.6m/s ² constant, X, Y, Z 1hour each.					
	Shock (In package)		Less than 196.1m/s ²					
	Cooling		Convection cooling					
Isolation	Withstand Voltage		Input - FG : 2kVAC (20mA), Input - Output : 3kVAC (20mA) Output - FG : 500VAC (100mA) for 1min					
	Isolation Resistance		More than 100MΩ at 25°C and 70%RH Output - FG : 500VDC					
Standards	Safety Standards (*12)		Approved by UL60950-1, CSA C22.2 No.60950-1, EN60950-1, EN50178 UL508 (with cover models only), CSA C22.2 No.14-M95 (with cover models only) Built to meet DENAN					
	PFHC		Built to meet IEC61000-3-2					
	EMI		Built to meet EN55011/EN55022-B, FCC-B, VCCI-B					
Mechanical	Immunity		Built to meet IEC61000-4-2(Level 2,3), -3(Level 3), -4(Level 3), -5(Level 3,4), -6(Level 3), -8(Level 4), -11					
	Weight (typ)	g	500					
	Size (W x H x D)	mm	37 x 82 x 160 (Refer to outline drawing)					

- (*1) At 100/200VAC, Ta=25°C and maximum output power.
- (*2) For cases where conformance to various safety specs (UL, CSA, EN) are required, to be described as 100 - 240VAC (50/60Hz).
- (*3) Not applicable for the in-rush current to noise filter for less than 0.2ms.
- (*4) Measure with JEITA RC-9131A probe, bandwidth of scope : 100MHz.
- (*5) 85 - 265VAC, constant load.
- (*6) No load-full load, constant input voltage.
- (*7) Constant current limit and hiccup with automatic recovery.
Not operate at over load or dead short condition for more than 30 seconds.
- (*8) OVP circuit will shutdown output, manual reset (re power on).
- (*9) At 100/200VAC, nominal output voltage and maximum output current.
- (*10) Measured by the each measuring method of UL, CSA, EN and DENAN (at 60Hz).
- (*11) Ratings - Derating at standard mounting.
- Load (%) is percent of maximum output power or maximum output current, whichever is greater.
- As for other mountings, refer to derating curve.
- (*12) As for DENAN, built to meet at 100VAC.

● Recommended EMC Filter

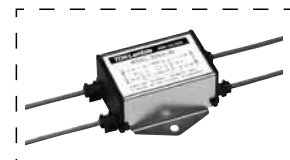

RSEL-2003W
Please refer to "TDK-Lambda EMC Filters" catalog.

HWS

HWS HD

HWS ME

HWS-P

Instruction Manual

Outline Drawing

[HWS150]

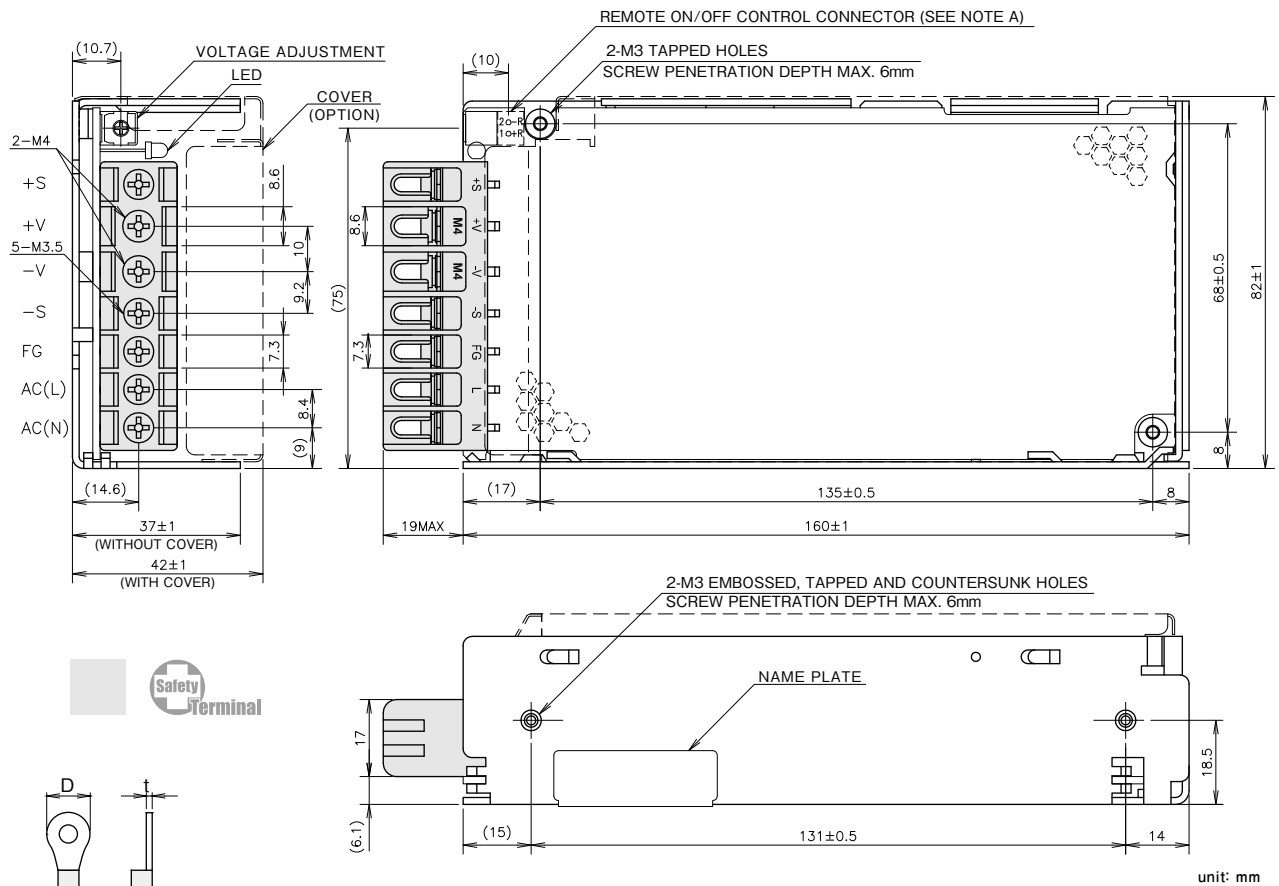

Terminal	Recommended Solderless Terminal		
	D (max)	t (max)	Qty (max)
+V / -V	8.1mm	0.8mm	2 pcs
		1.0mm	1 pc
Others	6.8mm	0.8mm	2 pcs

ACCESSORIES

* SHORT PIECE (NET 2) FOR SHORTING PURPOSE
 (+S to +V, -S to -V): MOUNTED AT TIME OF SHIPMENT.

NOTES

- A : REMOTE ON/OFF CONTROL CONNECTOR --- OPTION B2B-XH-AM (JST)
- MATCHING HOUSING : XHP-2 (JST)
- MATCHING TERMINAL : BXH-001T-P0.6 (JST) OR SXH-001T-P0.6 (JST)
- HAND CRIMPING TOOL : YC-110R (JST) OR YRS-110 (JST)

unit: mm

Output Derating

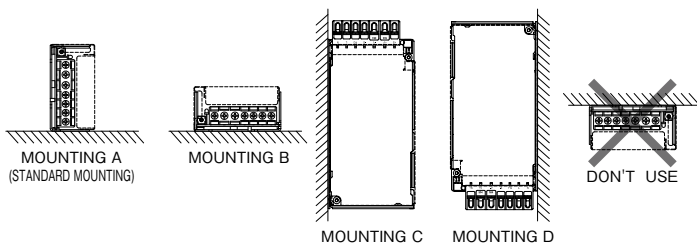
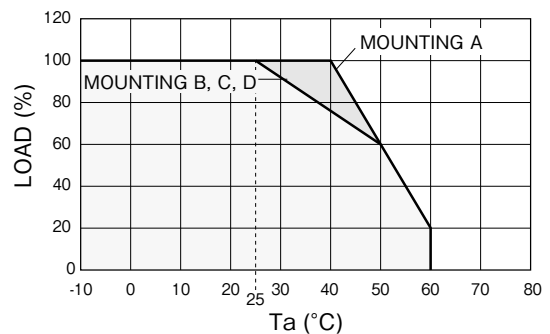
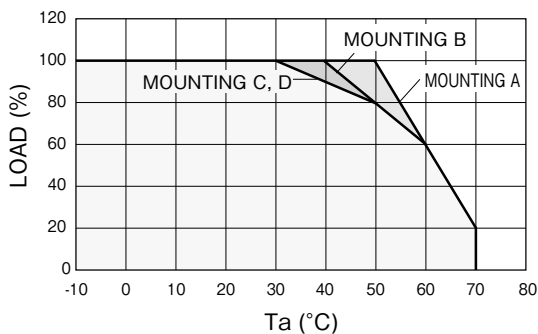

HWS300 Specifications (Read instruction manual carefully, before using the power supply unit.)

ITEMS/UNITS		MODEL	HWS300-3	HWS300-5	HWS300-12	HWS300-15	HWS300-24	HWS300-48	
Input	Voltage Range (*2)	V	AC85 - 265 or DC120 - 330						
	Frequency (*2)	Hz	47 - 63						
	Power Factor (100/200VAC)(typ) (*1)		0.99 / 0.95						
	Efficiency (100/200VAC)(typ) (*1)	%	74 / 77	79 / 82	80 / 83		82 / 85		
	Current (100/200VAC)(typ) (*1)	A	2.7 / 1.4	3.8 / 1.9	4.1 / 2.1				
	Inrush Current (100/200VAC)(typ) (*3)	A	20 / 40						
	Leakage Current (*10)	mA	Less than 0.75. (0.2 (typ) at 100VAC / 0.44 (typ) at 230VAC)						
Output	Nominal Voltage	VDC	3.3	5	12	15	24	48	
	Maximum Current (*13)	A	60		27	22	14 (16.5)		7
	Maximum Power	W	198	300	324	330	336		
	Maximum Line Regulation (*5)	mV	20		48	60	96	192	
	Maximum Load Regulation (*6)	mV	30		72	90	144	288	
	Temperature Coefficient		Less than 0.02% / °C						
	Maximum Ripple & Noise (0≤Ta≤70°C) (*4)	mVp-p	120		150		350		
	Maximum Ripple & Noise (-10≤Ta<0°C) (*4)	mVp-p	180		200		400		
	Hold-up Time (typ) (*9)	ms	20						
	Voltage Adjustable Range	VDC	2.64 - 3.96	4.0 - 6.0	9.6 - 14.4	12.0 - 18.0	19.2 - 28.8	38.4 - 52.8	
Function	Over Current Protection (*7)	A	>63		> 28.4	>23.1	>16.7	>7.4	
	Over Voltage Protection (*8)	V	4.13 - 4.95	6.25 - 7.25	15.0 - 17.4	18.8 - 21.8	30.0 - 34.8	55.2 - 64.8	
	Remote Sensing		Possible						
	Remote ON/OFF Control		Possible						
	Parallel Operation		Possible						
	Series Operation		Possible						
	Monitoring Signal		PF (Open collector output)						
	Line DIP		Designed to meet SEMI-F47 (200VAC Line only)						
	Environment	Operating Temperature (*11)	°C	-10 to +70 (-10 to +50: 100%, +70: 50%)					
		Storage Temperature	°C	-30 to +85					
Operating Humidity		%RH	10 - 90 (No dewdrop)						
Storage Humidity		%RH	10 - 95 (No dewdrop)						
Vibration			At no operating, 10 - 55Hz (sweep for 1min) 19.6m/s ² constant, X, Y, Z 1hour each.						
Shock (In package)			Less than 196.1m/s ²						
Cooling			Forced air by blower fan						
Isolation	Withstand Voltage		Input - FG : 2.5kVAC (20mA), Input - Output : 3kVAC (20mA) Output - FG: 500VAC (100mA), Output-CNT: 100VAC(100mA) for 1min						
	Isolation Resistance		More than 100MΩ Output - FG : 500VDC More than 10MΩ Output -CNT : 100VDC at 25°C and 70%RH						
Standards	Safety Standards (*12)		Approved by UL60950-1, UL508 (24V model only), CSA C22.2 No.60950-1, CSA C22.2 No.14-M95 (24V model only), EN60950-1, EN50178 Designed to meet DENAN						
	PFHC		Designed to meet IEC61000-3-2						
	EMI		Designed to meet EN55011/EN55022-B, FCC-B, VCCI-B						
	Immunity		Designed to meet IEC61000-4-2(Level 2,3), -3(Level 3), -4(Level3), -5(Level 3,4), -6(Level 3), -8(Level 4), -11						
Mechanical	Weight (typ)	g	1000						
	Size (W x H x D)	mm	61 x 82 x 165 (Refer to outline drawing)						

- (*1) At 100/200VAC, Ta=25°C and maximum output power.
- (*2) For cases where conformance to various safety specs (UL, CSA, EN) are required, to be described as 100-240VAC (50/60Hz).
- (*3) Not applicable for the inrush current to noise filter for less than 0.2ms.
- (*4) Measure with JEITA RC-9131A probe, bandwidth of scope :100MHz.
- (*5) 85 - 265VAC, constant load.
- (*6) No load-full load, constant input voltage.
- (*7) 3.3, 5V model: Constant current limit and hiccup with automatic recovery.
12 - 48V model: Constant current limit with automatic recovery.
Avoid to operate at over load or short circuit condition for more than 30 seconds.
- (*8) OVP circuit will shut the output down, manual reset (CNT reset or Re power on).
- (*9) At 100/200VAC, nominal output voltage and maximum output current.
- (*10) Measured by the each measuring method of UL, CSA, EN and DENAN (at 60Hz), Ta=25°C.
- (*11) Ratings - Derating at standard mounting. Refer to output derating curve.
- Load (%) is percent of maximum output power or maximum output current, whichever is greater.
- (*12) As for DENAN, designed to meet at 100VAC.
- (*13) () : Peak output current at 200VAC. Operating time at peak output is less than 10 sec, duty is less than 35%.

● Recommended EMC Filter



RSEN-2006
Please refer to "TDK-Lambda EMC Filters" catalog.

HWS

HWS HD

HWS ME

HWS-P

Instruction Manual

Outline Drawing

[HWS300]

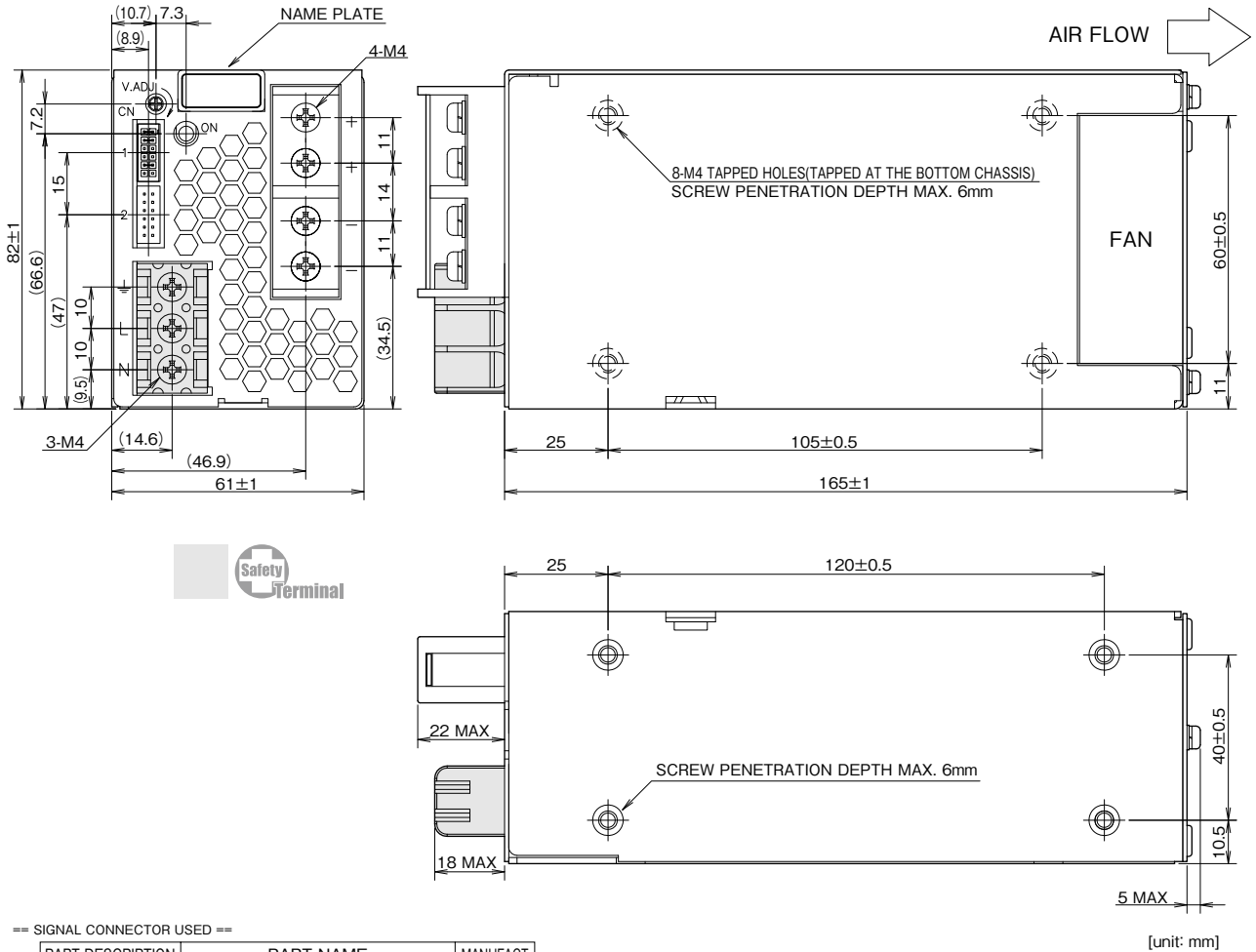

== SIGNAL CONNECTOR USED ==

PART DESCRIPTION	PART NAME	MANUFACT
PIN HEADER	S12B-PHDSS	JST

== MATCHING HOUSINGS, PINS & TOOL ==

PART DESCRIPTION	PART NAME	MANUFACT
SOCKET HOUSING	PHDR-12VS	JST
TERMINAL PINS	SPHD-002T-P0.5 (AWG28 - 24) SPHD-001T-P0.5 (AWG26 - 22)	JST
HAND CRIMPING TOOL	YRS-620 (SPHD-002T-P0.5) YC-610R (SPHD-001T-P0.5)	JST

== ACCESSORIES ==

- *COVER FOR BARRIER TERMINAL STRIP -----1 (ATTACHED ON TERMINAL AT SHIPMENT)
- *SHORT PIECE -----1
SHORTING +Vm---+S, -Vm---S, CNT---TOG (ATTACHED ON CN1 AT SHIPMENT)

[unit: mm]

Output Derating

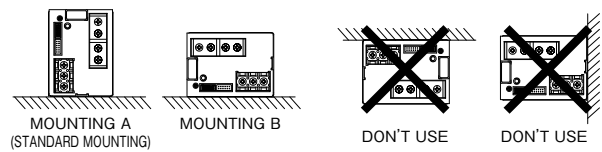
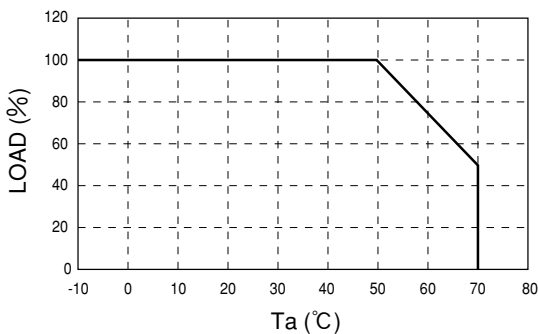

HWS600 Specifications (Read instruction manual carefully, before using the power supply unit.)

ITEMS/UNITS	MODEL	HWS600-3	HWS600-5	HWS600-12	HWS600-15	HWS600-24	HWS600-48	
Input	Voltage Range (*2)	V AC85 - 265 or DC120 - 330						
	Frequency (*2)	Hz 47 - 63						
	Power Factor (100/200VAC)(typ) (*1)	0.99 / 0.95						
	Efficiency (100/200VAC)(typ) (*1)	% 75 / 78	80 / 83		81 / 84		82 / 85	83 / 86
	Current (100/200VAC)(typ) (*1)	A 5.4 / 2.6	7.5 / 3.6		8.1 / 3.9			
	Inrush Current (100/200VAC)(typ) (*3)	A 20 / 40						
	Leakage Current (*10)	mA Less than 0.75. (0.2 (typ) at 100VAC / 0.44 (typ) at 230VAC)						
Output	Nominal Voltage	VDC 3.3	5	12	15	24	48	
	Maximum Current (*13)	A 120		53	43	27(31)		13
	Maximum Power	W 396	600	636	645	648	624	
	Maximum Line Regulation (*5)	mV 20		48	60	96	192	
	Maximum Load Regulation (*6)	mV 30		72	90	144	288	
	Temperature Coefficient	Less than 0.02% / °C						
	Maximum Ripple & Noise (0≤Ta≤70°C) (*4)	mVp-p 120		150		350		
	Maximum Ripple & Noise (-10≤Ta≤ 0°C) (*4)	mVp-p 180		200		400		
	Hold-up Time (typ) (*9)	ms 20ms						
	Voltage Adjustable Range	VDC 2.64 - 3.96	4.0 - 6.0	9.6 - 14.4	12.0 - 18.0	19.2 - 28.8	38.4 - 52.8	
Function	Over Current Protection (*7)	A >126		>55.7	>45.2	>31.4	>13.7	
	Over Voltage Protection (*8)	VDC 4.13 - 4.95	6.25 - 7.25	15.0 - 17.4	18.8 - 21.8	30.0 - 34.8	55.2 - 64.8	
	Remote Sensing	Possible						
	Remote ON/OFF Control	Possible						
	Parallel Operation	Possible						
	Series Operation	Possible						
	Monitoring Signal	PF (Open collector output)						
Line DIP	Designed to meet SEMI-F47 (200VAC Line only)							
Environment	Operating Temperature (*11)	°C -10 to +70 (-10 to +50: 100%, +70: 50%)						
	Storage Temperature	°C -30 to +85						
	Operating Humidity	%RH 10 - 90 (No dewdrop)						
	Storage Humidity	%RH 10 - 95 (No dewdrop)						
	Vibration	At no operating, 10 - 55Hz (sweep for 1min) 19.6m/s ² constant, X, Y, Z 1hour each.						
	Shock (In package)	Less than 196.1m/s ²						
Isolation	Withstand Voltage	Input - FG : 2.5kVAC (20mA), Input - Output : 3kVAC (20mA) Output - FG : 500VAC (100mA), Output - CNT : 100VAC (100mA) for 1min						
	Isolation Resistance	More than 100MΩ Output - FG : 500VDC More than 10MΩ Output - CNT: 100VDC at 25°C and 70%RH						
Standards	Safety Standards (*12)	Approved by UL60950-1, UL508 (24V model only), CSA C22.2 No.60950-1, CSA C22.2 No.14-M95 (24V model only), EN60950-1, EN50178, Designed to meet DENAN						
	PFHC	Designed to meet IEC61000-3-2						
	EMI	Designed to meet EN55011/EN55022-B, FCC-B, VCCI-B						
Mechanical	Immunity	Designed to meet IEC61000-4-2(Level 2,3), -3(Level 3), -4(Level 3), -5(Level 3,4), -6(Level 3), -8(Level 4), -11						
	Weight (typ)	g 1600						
	Size (W x H x D)	mm 100 x 82 x 165 (Refer to outline drawing)						

(*1) At 100/200VAC, Ta=25°C and maximum output power.

(*2) For cases where conformance to various safety specs (UL, CSA, EN) are required, to be described as 100 - 240VAC (50/60Hz).

(*3) Not applicable for the inrush current to noise filter for less than 0.2ms. Inrush current is 30A (typ) when PFHC start-up.

(*4) Measure with JEITA RC-9131A probe, bandwidth of scope :100MHz.

(*5) 85 - 265VAC, constant load.

(*6) No load - full load, constant input voltage.

(*7) 3V and 5V model: Constant current limit and hiccup with automatic recovery.
12 - 48V model: Constant current limit with automatic recovery.
Avoid to operate at over load or short circuit condition for more than 30 seconds.

(*8) OVP circuit will shut the output down, manual reset (CNT reset or re-power on).

(*9) At 100/200VAC, nominal output voltage and maximum output current.

(*10) Measured by the each measuring method of UL, CSA, EN and DENAN (at 60Hz), Ta=25°C.

(*11) Ratings - Derating at standard mounting. Refer to output derating curve.
- Load (%) is percent of maximum output power or maximum output current, whichever is greater.

(*12) As for DENAN, designed to meet at 100VAC.

(*13) () : Peak output current at 200VAC. Operating time at peak output is less than 10 sec, duty is less than 35%.

● Recommended EMC Filter



RSEN-2016
Please refer to "TDK-Lambda EMC Filters" catalog.

Outline Drawing

[HWS600]

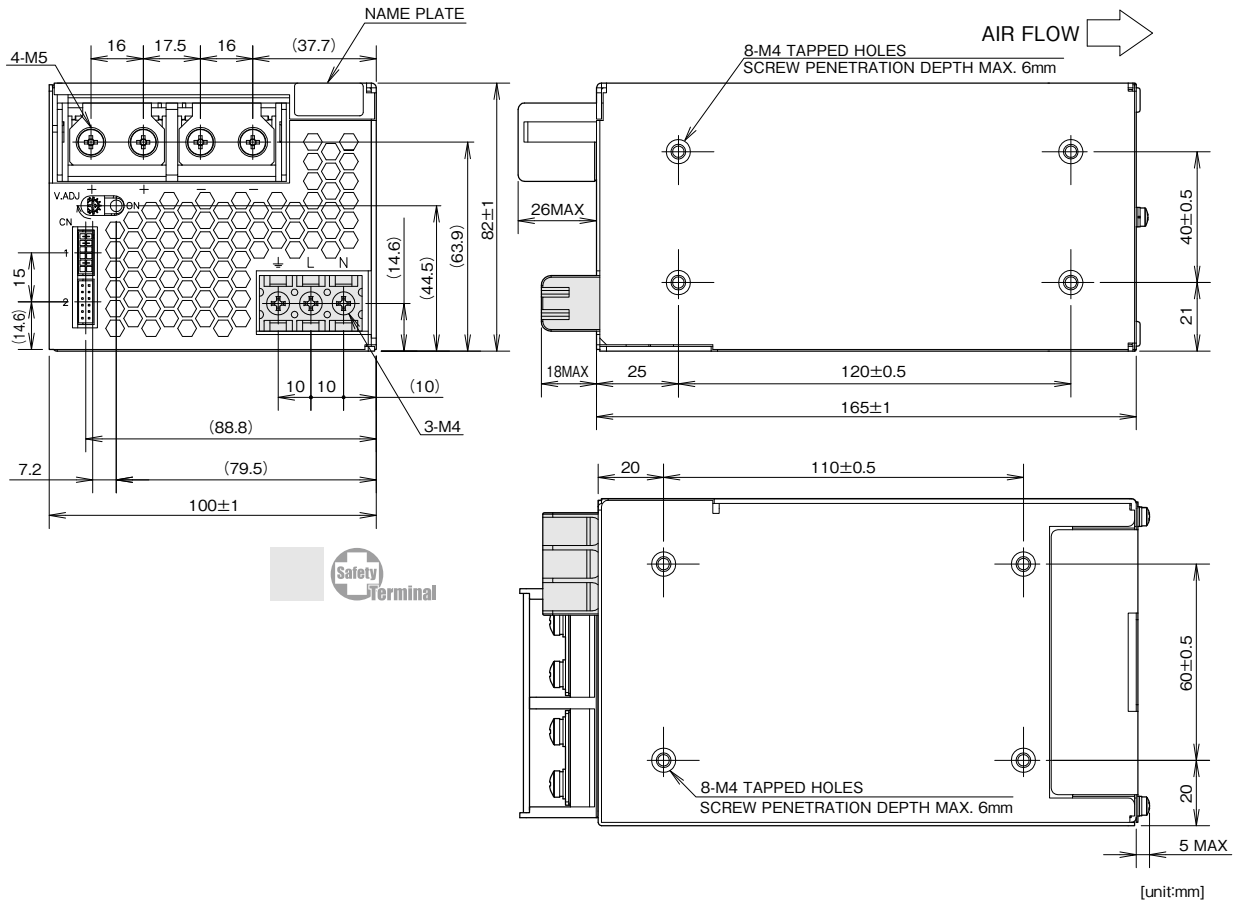

== SIGNAL CONNECTOR USED ==

PART DESCRIPTION	PART NAME	MANUFACT
PIN HEADER	S12B-PHDSS	JST

== MATCHING HOUSINGS, PINS & TOOL ==

PART DESCRIPTION	PART NAME	MANUFACT
SOCKET HOUSING	PHDR-12VS	JST
TERMINAL PINS	SPHD-002T-P0.5 (AWG28 - 24) SPHD-001T-P0.5 (AWG26 - 22)	JST
HAND CRIMPING TOOL	YRS-620 (SPHD-002T-P0.5) YC-610R (SPHD-001T-P0.5)	JST

== ACCESSORIES ==

- *COVER FOR BARRIER TERMINAL STRIP ----1 (ATTACHED ON TERMINAL AT SHIPMENT)
- *SHORT PIECE -----1 SHORTING +Vm—+S, -Vm—S, CNT—TOG (ATTACHED ON CN1 AT SHIPMENT)

Output Derating

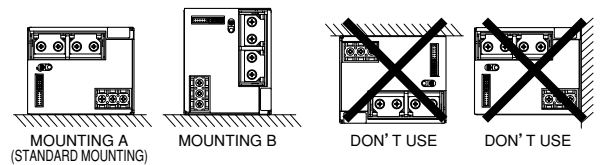
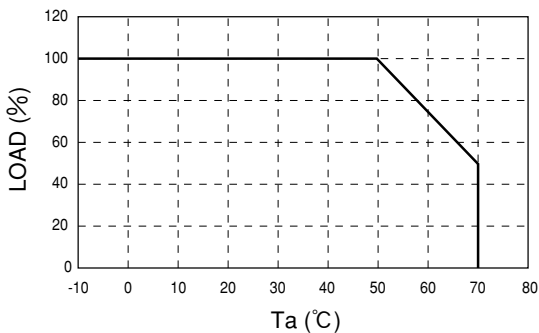

HWS1000 Specifications (Read instruction manual carefully, before using the power supply unit.)

ITEMS/UNITS		MODEL	HWS1000 -3	HWS1000 -5	HWS1000 -6	HWS1000 -7	HWS1000 -12	HWS1000 -15	HWS1000 -24	HWS1000 -36	HWS1000 -48	HWS1000 -60	
Input	Voltage Range (*2)	V	AC85 - 265 or DC120 - 330										
	Frequency (*2)	Hz	47 - 63										
	Power Factor (100/200VAC)(typ) (*1)		0.98 / 0.95										
	Efficiency (100/200VAC)(typ) (*1)	%	71 / 73	76 / 78	79 / 81	80 / 82	82 / 85	83 / 85	85 / 87	85 / 88	86 / 88	85 / 88	
	Current (100/200VAC)(typ) (*1)	A	9.6 / 5.0										
	Inrush Current (100/200VAC)(typ) (*3)	A	20 / 40										
	Leakage Current (100/240VAC) (*10)	mA	1.2 max										
Output	Nominal Voltage	VDC	3.3	5	6	7.5	12	15	24	36	48	60	
	Maximum Current	A	200		167	134	88	70	46	30.7	23	18.4	
	Maximum Peak Current (*13)	A	-		160	100	80	58.5	39	29.2	23.4		
	Maximum Power	W	660	1000	1002	1005	1056	1050	1104				
	Maximum Peak Power (*13)	W	-		1200	1404							
	Maximum Line Regulation (*5)	mV	20		36	48	60	96	144	192	240		
	Maximum Load Regulation (*6)	mV	40		60	100	120	150		300	360		
	Temperature Coefficient		Less than 0.02%/°C										
	Maximum	0 to +71°C	mVp-p	120		150			200		400		
		Ripple & Noise (*4)	-10 to 0°C	mVp-p	160		180			240		500	
	Hold-up Time (typ) (*9)	ms	20										
	Voltage Adjustable Range	VDC	2.64 - 3.96	4.0 - 6.0	4.8 - 7.2	6.0 - 9.0	9.6 - 14.4	12.0 - 18.0	19.2 - 28.8	28.8 - 43.2	38.4 - 52.8	48.0 - 66.0	
	Over Current Protection (*7)	A	>210.0		>175.3	>168.0	>105.0	>84.0	>61.4	>40.9	>30.6	>24.5	
Over Voltage Protection (*8)	VDC	4.12 - 4.62	6.25 - 7.0	7.5 - 8.4	9.37 - 10.5	15.0 - 17.4	18.7 - 21.8	30.0 - 34.8	45.0 - 49.7	55.2 - 60.0	69.0 - 75.0		
Remote Sensing		Possible											
Remote ON/OFF Control		Possible											
Parallel Operation		Possible											
Series Operation		Possible											
Monitoring Signal		PF (Open collector output)											
Line DIP		Built to meet SEMI-F47 (200VAC line only)											
Environment	Operating Temperature (*11)	°C	-10 to +71, start up -20 to +71										
		-10 to +40°C	%										
		+50°C	83.9		%								
		+71°C	%										
	Storage Temperature	°C	-30 to +85										
	Operating Humidity	%RH	10 - 90 (No Condensing)										
Storage Humidity	%RH	10 - 95 (No Condensing)											
Vibration		At no operating, 10 - 55Hz (sweep for 1min.) 19.6m/s ² constant, X, Y, Z 1hour each.											
Shock (In package)		Less than 196.1m/s ²											
Cooling		Forced air by blower fan											
Isolation	Withstand Voltage		Input - FG : 2kVAC (20mA), Input - Output : 3kVAC (20mA) Output-FG : 500VAC (300mA) (60V model 651VAC (390mA)), Output-CNT:100VAC (100mA) for 1min.										
	Isolation Resistance		More than 100MΩ Output - FG : 500VDC More than 10MΩ Output - CNT 100VDC at 25°C and 70%RH										
Standards	Safety Standards (*12)		Approved by UL60950-1, CSA C22.2 No60950-1, EN60950-1,EN50178. Built to meet DENAN.										
	PFHC		Built to meet IEC61000-3-2										
	EMI		Built to meet EN55011/EN55022-B, FCC-ClassB, VCCI-ClassB, CISPR-ClassB.										
Mechanical	Immunity		Built to meet IEC61000-4-2(Level 2,3), -3(Level 3), -4(Level 3), -5(Level 3,4), -6(Level 3), -8(Level 4), -11										
	Weight (max)	g	3200										
	Size (W x H x D)	mm	126.5 x 82 x 240 (Refer to outline drawing)										

- (*1) At Ta=25°C and maximum output power.
- (*2) For cases where conformance to various safety specs (UL, CSA, EN) are required, input voltage range will be 100 - 240VAC (50/60Hz).
- (*3) First in-rush current. Not applicable to the first 0.2ms in-rush current flowing into the power supply noise filter.
- (*4) Measure with JEITA RC-9131A probe, bandwidth of scope :100MHz.
(At 100uF electric capacitor and 0.47uF film capacitor on the test fixture board.)
- (*5) 85 - 265VAC, constant load.
- (*6) No load-full load, constant input voltage.
- (*7) Constant current limit with automatic recovery. Over current condition for more than 5 seconds will cause the output to shutdown.
Output current exceeding maximum rated output current for more then 10 seconds continuously will result to output shutdown.
- (*8) OVP circuit will shut down output, manual reset (power cycle) or ON/OFF CNT signal reset.
- (*9) At 100/200VAC, nominal output voltage and maximum output current.
- (*10) Measured by the each measuring method of UL, CSA, EN and DENAN (at 60Hz), Ta=25°C.
- (*11) Ratings - Derating at standard mounting.
 - Load (%) is percent of maximum output power or maximum output current, whichever is greater.
 - As for other mountings, refer to derating curve.
- (*12) As for DENAN, built to meet at 100VAC.
- (*13) Peak output current is less than 10 seconds, and duty 35% max.(200VAC Line only)

Recommended EMC Filter



RSEN-2020

Please refer to "TDK-Lambda EMC Filters" catalog.

Outline Drawing

[HWS1000]

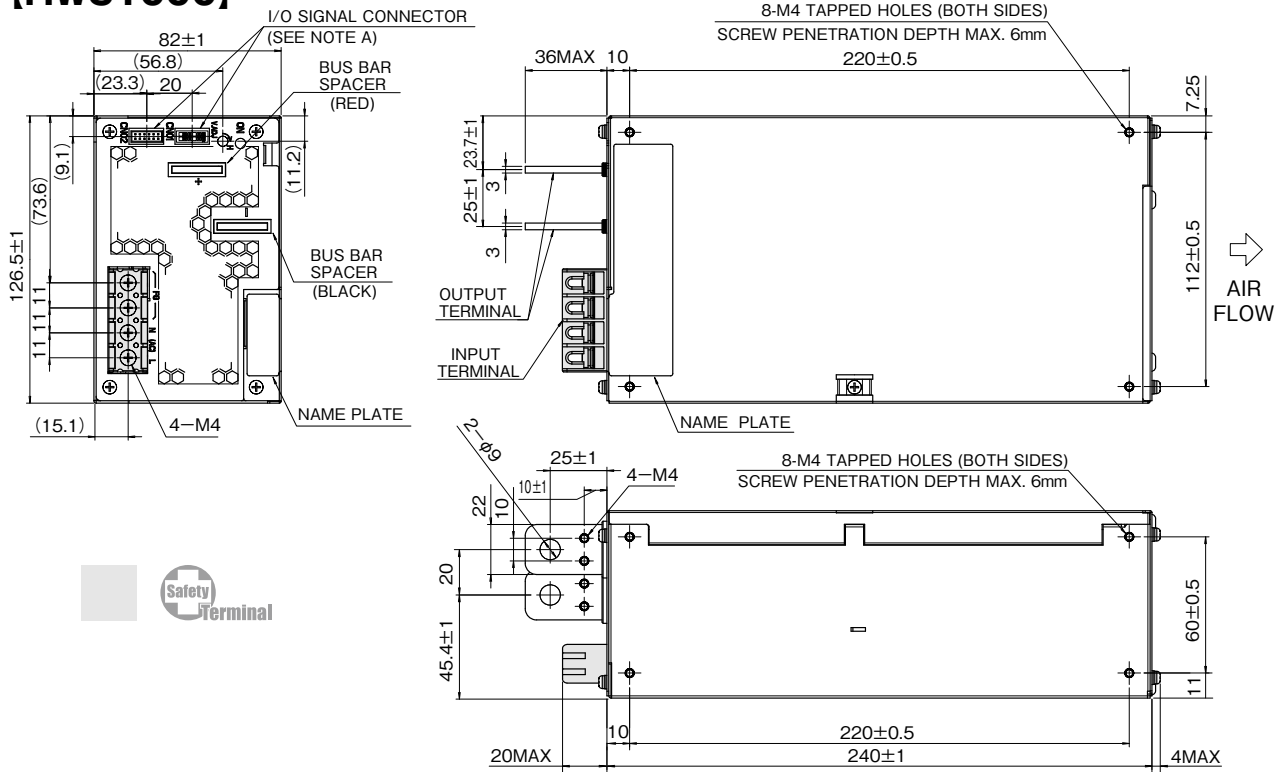

[unit: mm]

[Chassis material:SPCC-SD]

NOTES

A : I/O SIGNAL CONNECTOR

- | | | |
|--------------------|-------------------------------|----------|
| CONNECTOR | : S12B-PHDS (LF) (SN) | (JST) |
| MATCHING HOUSING | : PHDR-12VS | (JST) |
| MATCHING CONTACT | : SPHD-002T-P0.5 (AWG28 - 24) | (JST) OR |
| | SPHD-001T-P0.5 (AWG26 - 22) | (JST) OR |
| | BPHD-001T-P0.5 (AWG26 - 22) | (JST) |
| HAND CRIMPING TOOL | : YRS-620 (SPHD-002T-P0.5) | (JST) |
| | YC-610R (SPHD-001T-P0.5) | (JST) |
| | YC-610R (BPHD-001T-P0.5) | (JST) |

ACCESSORIES

- * ATTACHED CONNECTOR SHORTING +S ~ +V, -S ~ -V, PV ~ REF & CNT ~ TOG ATTACHED ON CN02 AT SHIPMENT
- * A separate connector not included is required in order to utilize the power supply function.

Output Derating

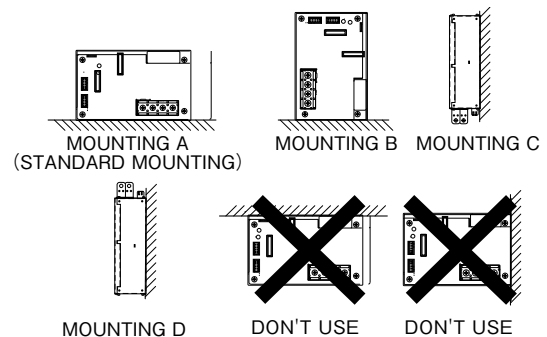
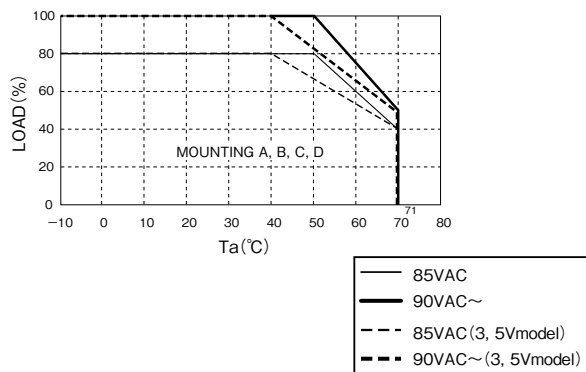

*It cannot be used even the product is flipped vertically.

HWS1500 Specifications (Read instruction manual carefully, before using the power supply unit.)

ITEMS/UNITS	MODEL	HWS1500													
		-3	-5	-6	-7	-12	-15	-24	-36	-48	-60				
Input	Voltage Range (*2)	AC85 - 265 or DC120 - 330													
	Frequency (*2)	47 - 63													
	Power Factor (100/230VAC)(typ) (*1)	0.98 / 0.94													
	Efficiency (100/200VAC)(typ) (*1)	%	72 / 75	77 / 81	79 / 82	81 / 83	82 / 85	83 / 87	84 / 88		86 / 90				
	Current (100/200VAC)(typ) (*1)	A	15.0 / 8.0		19.5 / 10.0		19.0 / 10.0								
	Inrush Current (100/200VAC)(typ) (*3)	A	20 / 40												
	Leakage Current (100/240VAC) (*10)	mA	1.5 max												
Output	Nominal Voltage	VDC	3.3	5	6	7.5	12	15	24	36	48	60			
	Maximum Current (100/200VAC)	A	300 / 300		250 / 250		200 / 200		125 / 125		100 / 100				
	Maximum Peak Current (*13)	A	-		300		240		-		105				
	Maximum Power (100/200VAC)	W	990 / 990		1500 / 1500				1560 / 1680		1512 / 1674				
	Maximum Peak Power (*13)	W	-		1800		-		2520						
	Maximum Line Regulation (*5)	mV	36			40		48		60		96			
	Maximum Load Regulation (*6)	mV	60			72		90		144		150			
	Temperature Coefficient	Less than 0.02%/°C													
	Maximum Ripple & Noise (*4)	+25 to +70°C	mVp-p	150				200				400			
		0°C	mVp-p	200				150				200			
		-10°C	mVp-p	220				200				240		400	
	Hold-up Time (typ) (*9)	ms	20			16		20							
	Voltage Adjustable Range	VDC	2.64 - 3.96	4.0 - 6.0	4.8 - 7.2	6.0 - 9.0	9.6 - 14.4	12.0 - 18.0	19.2 - 28.8	28.8 - 43.2	38.4 - 52.8	48.0 - 66.0			
Over Current Protection (*7)	A	>315.0		>262.5		>210.0		>131.2		>105.0		>68.2			
Over Voltage Protection (*8)	VDC	4.12 - 4.62	6.25 - 7.0	7.5 - 8.4	9.37 - 10.5	15.0 - 17.4	18.7 - 21.8	30.0 - 34.8	45.0 - 49.7	55.2 - 64.8	69.0 - 75.0				
Function	Remote Sensing	Possible													
	Remote ON/OFF Control	Possible													
	Parallel Operation	Possible													
	Series Operation	Possible													
	Monitoring Signal	PF (Open collector output)													
	Line DIP	Built to meet SEMI-F47 (200VAC Line only)													
Environment	Operating Temperature (*11)	°C	-10 to +70, start up -20 to +70												
		at Input Voltage 100VAC/200VAC	-10 to +40°C	W	990				1500				1560 / 1680		
			+50°C	W	825		1250		1500				1560 / 1680		
			+60°C	W	660		1000		1125				1170 / 1260		
	+70°C	W	495		750				780 / 840		756 / 837				
	Storage Temperature	°C	-30 to +85												
	Operating Humidity	%RH	10 - 90 (No Condensing)												
Storage Humidity	%RH	10 - 95 (No Condensing)													
Vibration	At no operating, 10 - 55Hz (sweep for 1min.) 19.6m/s ² constant, X, Y, Z 1hour each.														
Shock (In package)	Less than 196.1m/s ²														
Cooling	Forced air by blower fan														
Isolation	Withstand Voltage	Input - FG : 2kVAC (20mA), Input - Output : 3kVAC (20mA), Output - CNT : 100VAC (100mA) Output - FG : 500VAC (300mA), (60V model 651VAC (390mA)) for 1min.													
	Isolation Resistance	More than 100MΩ Output - FG : 500VDC More than 10MΩ Output - CNT 100VDC at 25°C and 70%RH													
Standards	Safety Standards (*12)	Approved by UL60950-1, CSA C22.2 No.60950-1, EN60950-1, EN50178. Built to meet DENAN.													
	PFHC	Built to meet IEC61000-3-2													
	EMI	Built to meet EN55011/EN55022-A, FCC-ClassA, VCCI-ClassA.													
Mechanical	Immunity	Built to meet IEC61000-4-2(Level 2,3), -3(Level 3), -4(Level 3), -5(Level 3,4), -6(Level 3), -8(Level 4), -11													
	Weight (typ)	g	4000					3800							
Size (W x H x D)	mm	126.5 x 82 x 280 (Refer to outline drawing)													

(*1) At Ta=25°C and maximum output power.
 (*2) For cases where conformance to various safety specs (UL, CSA, EN) are required, input voltage range will be 100 - 240VAC (50/60Hz).
 (*3) First in-rush current. Not applicable to the first 0.2ms in-rush current flowing into the power supply noise filter.
 (*4) Measure with JEITA RC-9131A probe, bandwidth of scope: 100MHz.
 (at 100uF electric capacitor and 0.47uF film capacitor on the test fixture board.)
 Ripple noise spec for ambient temperature between -10 to 25 is a linearity value with respect to the -10 degrees C and 25 degrees C specs.
 (*5) 85 - 265VAC, constant load.
 (*6) No load-Full load, constant input voltage.
 (*7) Constant current limit with automatic recovery. Over current condition for more than 5 seconds will cause the output to shutdown. Output current exceeding maximum rated output current for more than 10 seconds continuously will result to output shutdown.
 (*8) OVP circuit will shut down output, manual reset (power cycle) or ON/OFF CNT signal reset.
 (*9) At 100/200VAC, nominal output voltage and maximum output current.
 (*10) Measured by the each measuring method of UL, CSA, EN and DENAN (at 60Hz), Ta=25°C.
 (*11) Ratings - Derating at standard mounting.
 - Load (%) is percent of maximum output power or maximum output current, whichever is greater.
 - As for other mountings, refer to derating curve.
 (*12) As for DENAN, built to meet at 100VAC.
 (*13) Peak output current is less than 10 seconds, and duty 35% max. (200VAC Line only)

● Recommended EMC Filter



RSEN-2030
 Please refer to "TDK-Lambda EMC Filters" catalog.

Outline Drawing

[HWS1500]

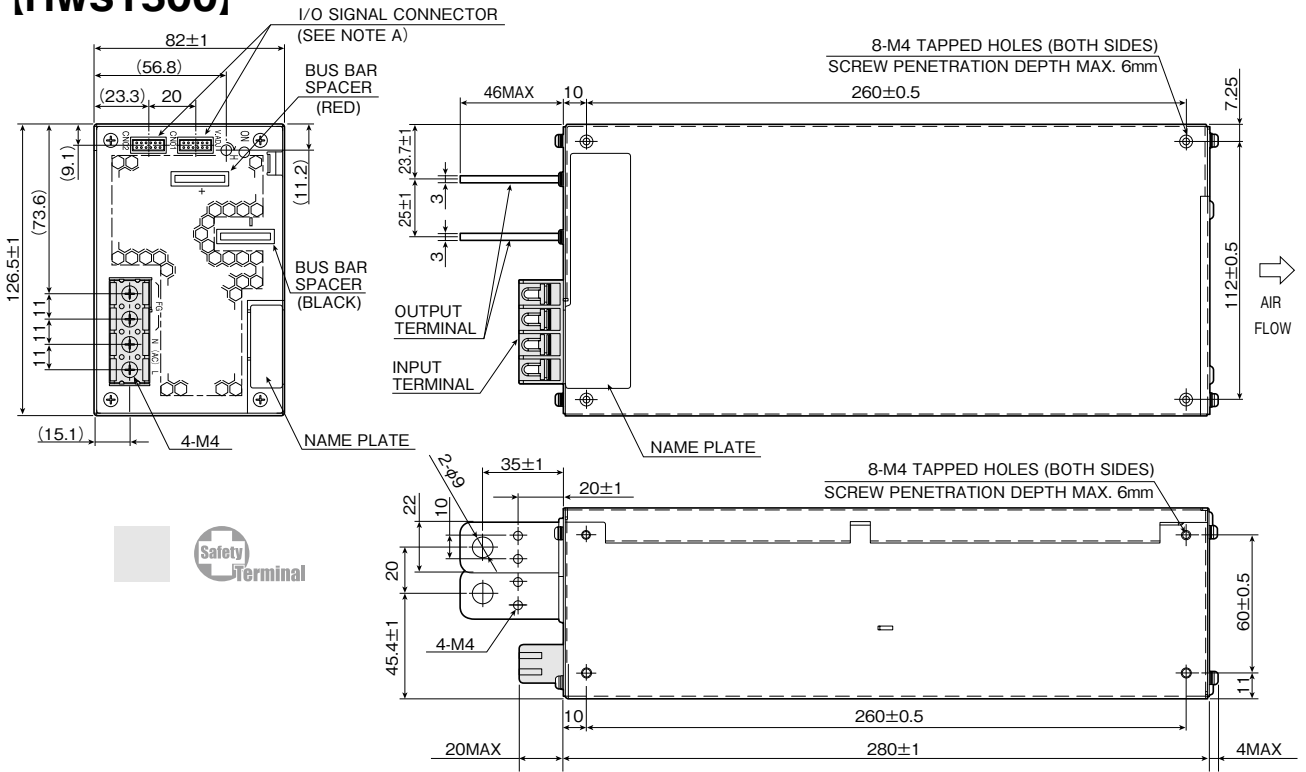

[unit: mm]
[Chassis material:SPCC-SD]

NOTES

A : I/O SIGNAL CONNECTOR

- | | | |
|--------------------|-------------------------------|----------|
| CONNECTOR | : S12B-PHDSS (LF) (SN) | (JST) |
| MATCHING HOUSING | : PHDR-12VS | (JST) |
| MATCHING CONTACT | : SPHD-002T-P0.5 (AWG28 - 24) | (JST) OR |
| | : SPHD-001T-P0.5 (AWG26 - 22) | (JST) OR |
| | : BPHD-001T-P0.5 (AWG26 - 22) | (JST) |
| HAND CRIMPING TOOL | : YRS-620 (SPHD-002T-P0.5) | (JST) |
| | : YC-610R (SPHD-001T-P0.5) | (JST) |
| | : YC-610R (BPHD-001T-P0.5) | (JST) |

ACCESSORIES

- * ATTACHED CONNECTOR
- SHORTING +S ~ +V, -S ~ -V, PV ~ REF & CNT ~ TOG ATTACHED ON CN01 AT SHIPMENT
- * A separate connector not included is required in order to utilize the power supply function.

Output Derating

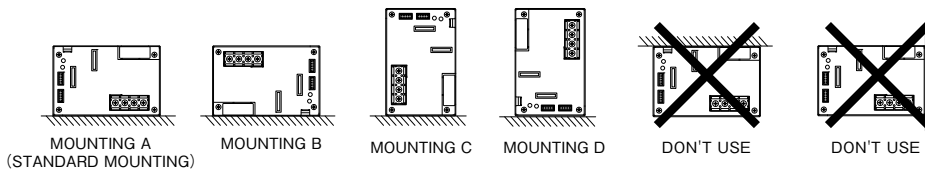
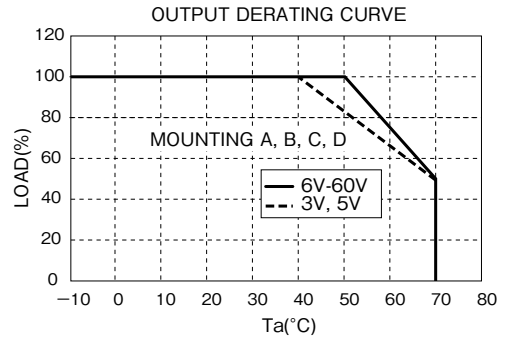
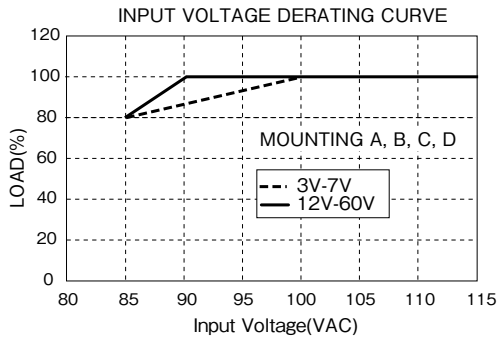

*It cannot be used even the product is flipped vertically.

HWS1800T Specifications (Read instruction manual carefully, before using the power supply unit.)

ITEMS/UNITS		MODEL	HWS1800T-3	HWS1800T-5	HWS1800T-6	HWS1800T-7	HWS1800T-12	HWS1800T-15	HWS1800T-24	HWS1800T-36	HWS1800T-48	HWS1800T-60		
Input	Voltage Range (*2)	V	3φ AC170 - 265											
	Frequency (*2)	Hz	47 - 63											
	Power Factor (200VAC)(typ) (*1)		0.94											
	Efficiency (200VAC)(typ) (*1)	%	75	81	82	84				88	90			
	Current (200VAC)(typ) (*1)	A	4.5	6.0						7.0				
	Inrush Current (200VAC)(typ) (*3)	A	40											
	Leakage Current (240VAC) (*10)	mA	2.6 max											
Output	Nominal Voltage	VDC	3.3	5	6	7.5	12	15	24	36	48	60		
	Maximum Current	A	300		250	200	125	100	75	50	37.5	30		
	Maximum Peak Current (*12)	A	-		300	240	150	120	105	70	52.5	42		
	Maximum Power	W	990	1500						1800				
	Maximum Peak Power (*12)	W	-		1800				2520					
	Maximum Line Regulation (*5)	mV	36			40	48	60	96	144	192	240		
	Maximum Load Regulation (*6)	mV	60						72	90	144	216	288	360
	Temperature Coefficient		Less than 0.02%/°C											
	Ripple & Noise (*4)	Maximum	+25 to +71°C	150			200			250	300	400		
			0°C	200						250	300	400		
			-10°C	220			250			300	400	600		
	Hold-up Time (typ) (*9)	ms	20						18					
Voltage Adjustable Range	VDC	2.64-3.96	4.0-6.0	4.8-7.2	6.0-9.0	9.6-14.4	12.0-18.0	19.2-28.8	28.8-43.2	38.4-52.8	48.0-66.0			
Over Current Protection (*7)	A	>315.0		>303.0	>242.4	>151.5	>121.2	>106.0	>70.7	>53.0	>42.4			
Over Voltage Protection (*8)	VDC	4.12-4.62	6.25-7.0	7.5-8.4	9.37-10.5	15.0-17.4	18.7-21.8	30.0-34.8	45.0-49.7	55.2-60.0	69.0-75.0			
Remote Sensing		Possible												
Remote ON/OFF Control		Possible												
Output Voltage External Control		Possible												
Parallel Operation		Possible												
Series Operation		Possible												
Monitoring Signal		PF (Open collector output)												
Line DIP		Built to meet SEMI-F47												
Environment	Operating Temperature (*11)	°C	-10 to +71, Start up -20 to +71											
		-10 to +40°C	W	990	1500						1800			
		+50°C	W	825	1250	1500				1680				
		+60°C	W	660	1000	1125				1300				
		+71°C	W	495	750						900			
	Storage Temperature	°C	-30 to +85											
Operating Humidity	%RH	10 - 90 (No Condensing)												
Storage Humidity	%RH	10 - 95 (No Condensing)												
Vibration		At no operating, 10 - 55Hz (sweep for 1min.) 19.6m/s ² constant, X, Y, Z 1hour each.												
Shock (In package)		Less than 196.1m/s ²												
Cooling		Forced air by blower fan												
Isolation	Withstand Voltage		Input - FG : 2kVAC (20mA), Input - Output : 3kVAC (20mA), Output-FG : 500VAC (300mA), (60V model 651VAC(390mA)), Output-CNT:100VAC (100mA) for 1min											
	Isolation Resistance		More than 100MΩ Output - FG : 500VDC More than 10MΩ Output - CNT 100VDC at 25°C and 70%RH											
Standards	Safety Standards		Approved by UL60950-1, CSA C22.2 No.60950-1, EN60950-1											
	EMI		Built to meet EN55011/EN55022-A, FCC-ClassA, VCCI-ClassA.											
	Immunity		Built to meet IEC61000-4-2(Level 2,3), -3(Level 3), -4(Level 3), -5(Level 3,4), -6(Level 3), -8(Level 4), -11											
Mechanical	Weight (typ)	g	4000						3800					
	Size (W x H x D)	mm	126.5 x 82 x 280 (Refer to outline drawing)											

(*1) At Ta=25°C and maximum output power.

(*2) For cases where conformance to various safety specs (UL, CSA, EN) are required, input voltage range will be 200 - 240VAC (50/60Hz).

(*3) First in-rush current. Not applicable to the first 0.2ms in-rush current flowing into the power supply noise filter.

(*4) Measure with JEITA RC-9131A probe, bandwidth of scope: 100MHz.
(At 100uF electric capacitor and 0.47uF film capacitor on the test fixture board.)
Ripple noise spec for ambient temperature between -10 to 25 is a linearity value with respect to the -10 degrees C and 25 degrees C specs.

(*5) 170 - 265VAC, constant load.

(*6) No load-full load, constant input voltage.

(*7) Constant current limit with automatic recovery. Over current condition for more than 5 seconds will cause the output to shutdown.
Output current exceeding maximum rated output current for more than 10 seconds continuously will result to output shutdown.

(*8) OVP circuit will shut down output, manual reset (power cycle) or ON/OFF CNT signal reset.

(*9) At 200VAC(50/60Hz), nominal output voltage and maximum output current.

(*10) Measured by the each measuring method of UL, CSA and EN (at 60Hz, Ta=25°C).

(*11) Ratings - Derating at standard mounting.
- As for other mountings, refer to derating curve.

(*12) Peak output current is less than 10 seconds, and duty 35% max.

Recommended EMC Filter



RTEN-5020

Please refer to "TDK-Lambda EMC Filters" catalog.

HWS

HWS HD

HWS ME

HWS-P

Instruction Manual

Outline Drawing

[HWS1800T]

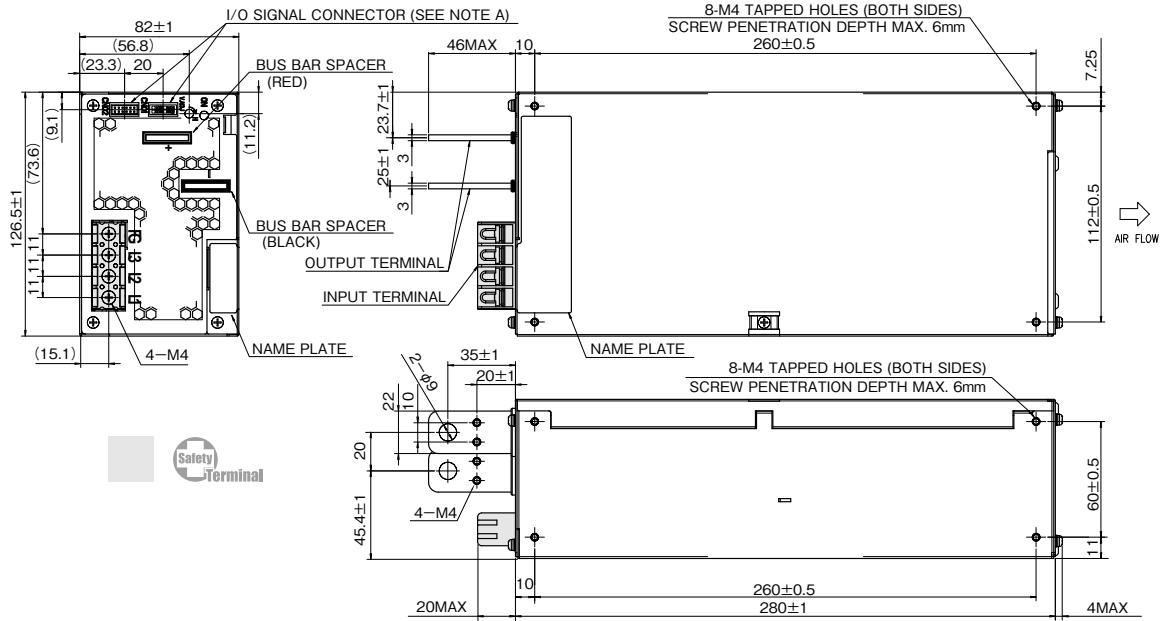

[unit: mm]
[Chassis material:SPCC-SD]

NOTES

A : I/O SIGNAL CONNECTOR

- | | | |
|--------------------|-------------------------------|----------|
| CONNECTOR | : S12B-PHDSS (LF) (SN) | (JST) |
| MATCHING HOUSING | : PHDR-12VS | (JST) |
| MATCHING CONTACT | : SPHD-002T-P0.5 (AWG28 - 24) | (JST) OR |
| | : SPHD-001T-P0.5 (AWG26 - 22) | (JST) OR |
| | : BPHD-001T-P0.5 (AWG26 - 22) | (JST) |
| HAND CRIMPING TOOL | : YRS-620 (SPHD-002T-P0.5) | (JST) |
| | : YC-610R (SPHD-001T-P0.5) | (JST) |
| | : YC-610R (BPHD-001T-P0.5) | (JST) |

ACCESSORIES

- * ATTACHED CONNECTOR (3 - 7V)
SHORTING +S ~ (+), -S ~ (-), PV ~ REF & CNT ~ TOG ATTACHED ON CN01 AT SHIPMENT
- * ATTACHED CONNECTOR (12 - 60V)
SHORTING +S ~ +V, -S ~ -V, PV ~ REF & CNT ~ TOG ATTACHED ON CN01 AT SHIPMENT
- * A separate connector not included is required in order to utilize the power supply function.

Output Derating

[HWS1800T 3V]

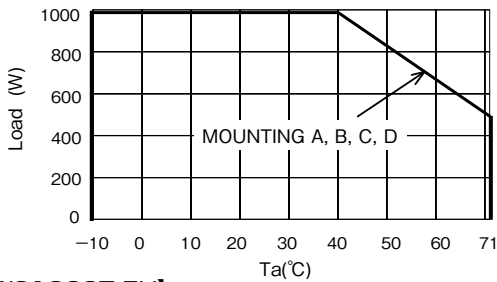

[HWS1800T 6V-15V]

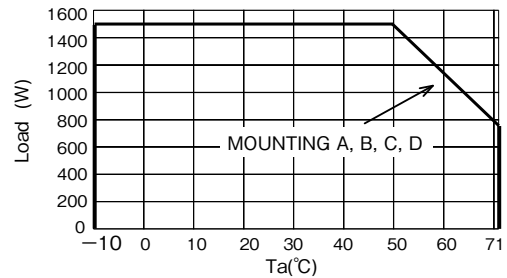

[HWS1800T 5V]

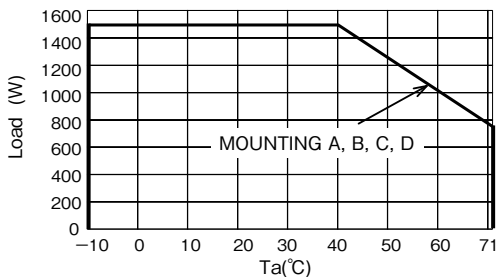

[HWS1800T 24V-60V]

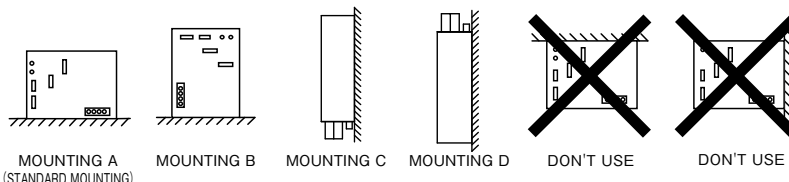
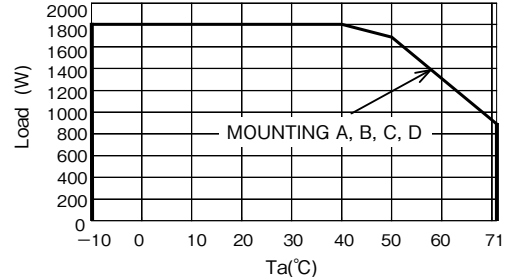

TDK·Lambda

HWS/HD

Single Output 30W-1800W

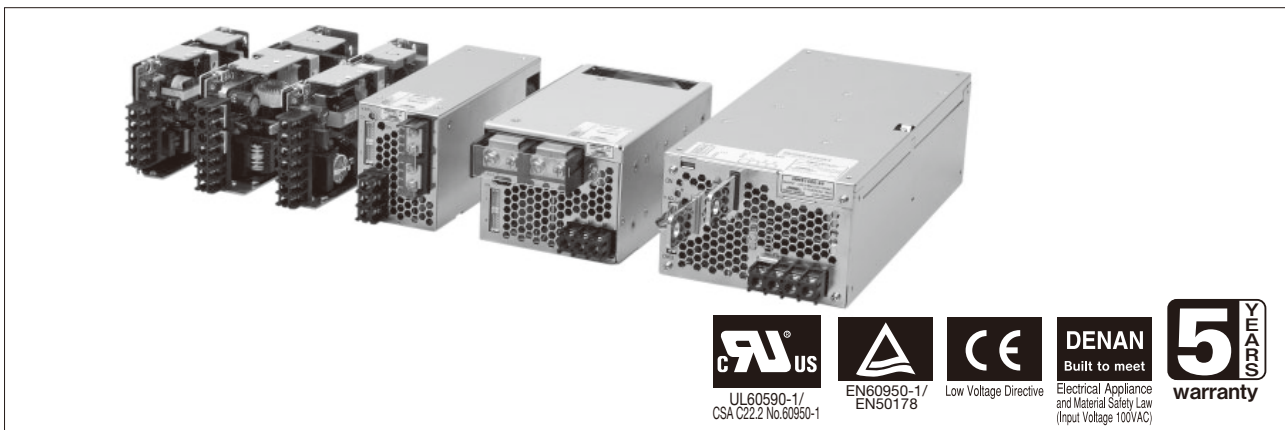

Features

- Power supply for harsh environment, heavy industry equipment, etc.
 - Guaranteed start-up at Ta=-40°C. (*1)
 - Internal PCB coating (*2)
 - Compliant to MIL-STD-810F, the standard for the products for military use (vibration resistance /shock resistance).
- Environmentally-friendly: Conforming to RoHS directives.

High-efficiency technology reduces power loss by heat generation. Fan stopping in power-off by external control reduces acoustic noise and saves energy.
- Easy to use: All models in the same height of 82mm. Mountable in 2U-height racks without dead space.
- Safety and reliability: “Safety terminal” covering current flowing part secures safety for users. “No screw-dropping” design prevents from losing screws during maintenance operation.
- HWS1500-48/HD realizes as high efficiency as 90%. Synchronous rectifier circuit improved efficiency of low voltage models by over 10% (HWS150-5/HD).

Model naming method

[HWS30-150]
HWS 50 – 5 / HD
 Series name Output power HD : Without cover for harsh environment
 Nominal output voltage
 ex. 3: 3.3V, 5: 5V, 48: 48V

[HWS300-1800]
HWS 300 – 5 / HD
 Series name Output power HD : With cover for harsh environment by forced air cooling
 Nominal output voltage
 ex. 3: 3.3V, 5: 5V, 48: 48V

Applications



Conformity to RoHS Directive

This means that, in conformity with EU Directive 2002/95/EC, lead, cadmium, mercury, hexavalent chromium, and specific bromine-based flame retardants, PBB and PBDE, have not been used, except for exempted applications.

Product Line up

Output Voltage	30W		50W		100W		150W		300W	
	Output Current	Model	Output Current	Model	Output Current	Model	Output Current	Model	Output Current (Peak)	Model
3.3V	6A	HWS30-3/HD	10A	HWS50-3/HD	20A	HWS100-3/HD	30A	HWS150-3/HD	60A	HWS300-3/HD
5V	6A	HWS30-5/HD	10A	HWS50-5/HD	20A	HWS100-5/HD	30A	HWS150-5/HD	60A	HWS300-5/HD
12V	2.5A	HWS30-12/HD	4.3A	HWS50-12/HD	8.5A	HWS100-12/HD	13A	HWS150-12/HD	27A	HWS300-12/HD
15V	2A	HWS30-15/HD	3.5A	HWS50-15/HD	7A	HWS100-15/HD	10A	HWS150-15/HD	22A	HWS300-15/HD
24V	1.3A	HWS30-24/HD	2.2A	HWS50-24/HD	4.5A	HWS100-24/HD	6.5A	HWS150-24/HD	14A (16.5A)	HWS300-24/HD
48V	0.65A	HWS30-48/HD	1.1A	HWS50-48/HD	2.1A	HWS100-48/HD	3.3A	HWS150-48/HD	7A	HWS300-48/HD

Output Voltage	600W		1000W		1500W		1800W	
	Output Current (Peak)	Model	Output Current (Peak)	Model	Output Current (Peak)(*)	Model	Output Current (Peak)	Model
3.3V	120A	HWS600-3/HD	200A	HWS1000-3/HD	300A/300A	HWS1500-3/HD	300A	HWS1800T-3/HD
5V	120A	HWS600-5/HD	200A	HWS1000-5/HD	300A/300A	HWS1500-5/HD	300A	HWS1800T-5/HD
6V	—	—	167A	HWS1000-6/HD	250A/250A(300A)	HWS1500-6/HD	250A (300A)	HWS1800T-6/HD
7.5V	—	—	134A (160A)	HWS1000-7/HD	200A/200A(240A)	HWS1500-7/HD	200A (240A)	HWS1800T-7/HD
12V	53A	HWS600-12/HD	88A (100A)	HWS1000-12/HD	125A/125A	HWS1500-12/HD	125A (150A)	HWS1800T-12/HD
15V	43A	HWS600-15/HD	70A (80A)	HWS1000-15/HD	100A/100A	HWS1500-15/HD	100A (120A)	HWS1800T-15/HD
24V	27A (31A)	HWS600-24/HD	46A (58.5A)	HWS1000-24/HD	65A/70A (105A)	HWS1500-24/HD	75A (105A)	HWS1800T-24/HD
36V	—	—	30.7A (39A)	HWS1000-36/HD	42A/46.5A (70A)	HWS1500-36/HD	50A (70A)	HWS1800T-36/HD
48V	13A	HWS600-48/HD	23A (29.2A)	HWS1000-48/HD	32A/32A	HWS1500-48/HD	37.5A (52.5A)	HWS1800T-48/HD
60V	—	—	18.4A (23.4A)	HWS1000-60/HD	25.6A/28A(42A)	HWS1500-60/HD	30A (42A)	HWS1800T-60/HD

(*1) The power supply might not start up according to the input voltage and the load condition at the low temperature (-40 < Ta < -10°C). (*2) For resistance against humidity, dust-related improvement-resistant, board both sides are coated.

(*2) For resistance against humidity, dust-related improvement-resistant, board both sides are coated. But it may not be completely possible for the effect because there is the point that is not coated partly. Please refer for the details to us.

• All specifications are subject to change without notice.

HWS30/HD Specifications (Read instruction manual carefully, before using the power supply unit.)

ITEMS/UNITS		MODEL	HWS30-3/HD	HWS30-5/HD	HWS30-12/HD	HWS30-15/HD	HWS30-24/HD	HWS30-48/HD	
Input	Voltage Range	(*2) V	AC85 - 265 or DC120 - 370						
	Frequency	(*2) Hz	47 - 63						
	Efficiency (100/200VAC)(typ)	(*1) %	70/73	77/80	81/83	83/86	82/83		
	Current (100/200VAC)(typ)	(*1) A	0.6/0.3	0.8/0.4					
	Inrush Current (typ)	(*3) A	14A at 100VAC, 28 at 200VAC, Ta=25° C, Cold Start						
	Leakage Current	(*10) mA	Less than 0.5m. (0.2(Typ) at 100VAC / 0.4mA(Typ) at 230VAC)						
Output	Nominal Voltage	VDC	3.3	5	12	15	24	48	
	Maximum Current	A	6	2.5	2	1.3	0.65		
	Maximum Power	W	20	30	31.2				
	Maximum Line Regulation	(*5) mV	20	48	60	96	192		
	Maximum Load Regulation	(*6) mV	40	96	120	192	384		
	Temperature Coefficient		Less than 0.02% / °C						
	Maximum Ripple & Noise (0≤Ta≤71°C) (*4)	mVp-p	120	150	200				
	Maximum Ripple & Noise (-10≤Ta<0°C) (*4)	mVp-p	160	180	240				
	Hold-up Time (typ)	(*9) ms	20						
	Voltage Adjustable Range	VDC	2.97-3.96	4.0-6.0	9.6-14.4	12.0-18.0	19.2-28.8	38.4-52.8	
	Function	Over Current Protection	(*7) A	>6.3		>2.62	>2.1	>1.36	>0.68
Over Voltage Protection		(*8) VDC	4.13-4.95	6.25-7.25	15.0-17.4	18.8-21.8	30.0-34.8	55.2-64.8	
Remote Sensing			-						
Parallel Operation			-						
Series Operation			Possible						
Line DIP			Designed to meet SEMI-F47 (200VAC Line only)						
Environment	Operating Temperature	(*11) °C	-10 to +71 (-10 to +50:100%, +60:60%, +71:20%) Guarantee Start up at -40 to -10						
	Storage Temperature	°C	-40 to +85						
	Operating Humidity	%RH	30 to 90 (No dewdrop)						
	Storage Humidity	%RH	10 to 95 (No dewdrop)						
	Vibration	(*12)	At no operating, 10 - 55Hz (Sweep for 1min) 19.6m/s² Constant, X,Y,Z 1hour each. Designed to meet MIL-STD-810F 514.5 Category 4, 10						
	Shock (In package)		Less than 196.1m/s² Designed to meet MIL-STD-810F 516.5 Procedure I, VI						
	Cooling		Convection Cooling						
Isolation	Withstand Voltage		Input - FG : 2kVAC (20mA), Input - Output : 3kVAC (20mA) Output - FG : 500VAC (100mA) for 1min						
	Isolation Resistance		More than 100MΩ at 25° C and 70%RH Output - FG : 500VDC						
Standards	Safety Standards	(*13)	Approved by UL60950-1, CSA60950-1, EN60950-1, EN50178 Designed to meet UL508, DENAN						
	PFHC		Designed to meet IEC61000-3-2						
	EMI		Designed to meet EN55011/EN55022-B, FCC-B, VCCI-B						
	Immunity		Designed to meet IEC61000-4-2(Level 2,3), -3(Level 3), -4(Level 3), -5(Level 3,4), -6(Level 3), -8(Level 4), -11						
Mechanical	Weight (typ)	g	220g						
	Size (W×H×D)	mm	26.5 x 82 x 95 (Refer to Outline Drawing)						

- (*1) At 100/200VAC, Ta=25°C and maximum output power.
- (*2) For cases where conformance to various safety specs (UL, CSA, EN) are required, to be described as 100 - 240VAC(50/60Hz).
- (*3) Not applicable for the in-rush current to Noise Filter for less than 0.2ms.
- (*4) Measure with JEITA RC-9131A probe, Bandwidth of scope :100MHz.
For start up at low ambient temperature and low input voltage, output ripple noise might not meet specification. However, there is no overshoot at start up and output ripple noise specification can be met after one second.
- (*5) 85 - 265VAC , constant load.
- (*6) No load-Full load, constant input voltage.
- (*7) Foldback current limit with automatic recovery. Not operate at over load or dead short condition for more than 30seconds.
- (*8) OVP circuit will shutdown output, manual reset (Re power on).
- (*9) At 100/200VAC , Ta=25°C, nominal output voltage and maximum output current.
- (*10) Measured by the each measuring method of UL,CSA,EN and DENAN(at 60Hz).
- (*11) Ratings - Derating at standard mounting.
 - Load (%) is percent of maximum output power or maximum output current, whichever is greater.
 - As for other mountings, refer to derating curve.
 - For conditions of start up at -40° C to -30° C, refer to derating curve.
 - For conditions of start up at -30° C to -10° C, refer to derating curve.
- (*12) Category 4 exposure levels : Track transportation over U.S. highways, Composite two-wheeled trailer.
- (*13) As for DENAN, designed to meet at 100VAC.

● Recommended EMC Filter

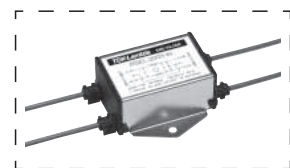

RSEL-2001W
Please refer to "TDK-Lambda EMC Filters" catalog.

HWS50/HD Specifications (Read instruction manual carefully, before using the power supply unit.)

ITEMS/UNITS		MODEL	HWS50-3/HD	HWS50-5/HD	HWS50-12/HD	HWS50-15/HD	HWS50-24/HD	HWS50-48/HD		
Input	Voltage Range (*3)	V	AC85 - 265 or DC120 - 370							
	Frequency (*3)	Hz	47 - 63							
	Power Factor (100/200VAC)(typ) (*2)		0.98 / 0.90		0.99 / 0.95					
	Efficiency (100/200VAC)(typ) (*2)	%	76 / 78		82 / 84		81 / 83		82 / 84	83 / 85
	Current (100/200VAC)(typ) (*2)	A	0.5 / 0.25		0.7 / 0.35					
	Inrush Current (100/200VAC)(typ) (*4)	A	14 / 28 Ta=25°C, cold start							
	Leakage Current (*11)	mA	Less than 0.5. (0.2 (typ) at 100VAC / 0.4 (typ) at 230VAC)							
Output	Nominal Voltage	VDC	3.3	5	12	15	24	48		
	Minimum Current (*1)	A	0.1		0.04		0.02	0.01		
	Maximum Current	A	10		4.3	3.5	2.2	1.1		
	Maximum Power	W	33	50	51.6	52.5	52.8			
	Maximum Line Regulation (*6)	mV	20		48	60	96	192		
	Maximum Load Regulation (*7)	mV	40		96	120	192	384		
	Temperature Coefficient		Less than 0.02% / °C							
	Maximum Ripple & Noise (0≤Ta≤71°C) (*5)	mVp-p	120		150		200			
	Maximum Ripple & Noise (-10≤Ta<0°C) (*5)	mVp-p	160		180		240			
	Hold-up Time (typ) (*10)	ms	20							
	Function	Voltage Adjustable Range	VDC	2.97 - 3.96	4.0 - 6.0	9.6 - 14.4	12.0 - 18.0	19.2 - 28.8	38.4 - 52.8	
Over Current Protection (*8)		A	>10.5		>4.51	>3.67	>2.31	>1.15		
Over Voltage Protection (*9)		VDC	4.13 - 4.95	6.25 - 7.25	15.0 - 17.4	18.8 - 21.8	30.0 - 34.8	55.2 - 64.8		
Remote Sensing			-							
Parallel Operation			-							
Series Operation			Possible							
Line DIP			Designed to meet SEMI-F47 (200VAC Line only)							
Operating Temperature (*12)		°C	-10 to +71 (-10 to +50: 100%, +60: 60%, +71: 20%) Guarantee start up at -40 to -10°C							
Storage Temperature		°C	-40 to +85							
Operating Humidity		%RH	30 - 90 (No dewdrop)							
Environment	Storage Humidity	%RH	10 - 95 (No dewdrop)							
	Vibration (*13)		At no operating, 10 - 55Hz (sweep for 1min) 19.6m/s ² constant, X, Y, Z 1hour each. Designed to meet MIL-STD-810F 514.5 Category 4, 10							
	Shock (In package)		Less than 196.1m/s ² Designed to meet MIL-STD-810F 516.5 Procedure I, VI							
	Cooling		Convection cooling							
	Withstand Voltage		Input - FG : 2kVAC (20mA), Input - Output : 3kVAC (20mA) Output - FG : 500VAC (100mA) for 1min							
	Isolation Resistance		More than 100MΩ at 25°C and 70%RH Output - FG : 500VDC							
Standards	Safety Standards (*14)		Approved by UL60950-1, CSA C22.2 No.60950-1, EN60950-1, EN50178 Designed to meet UL508, DENAN							
	PFHC		Designed to meet IEC61000-3-2							
	EMI		Designed to meet EN55011/EN55022-B, FCC-B, VCCI-B							
	Immunity		Designed to meet IEC61000-4-2(Level 2,3), -3(Level 3), -4(Level 3), -5(Level 3,4), -6(Level 3), -8(Level 4), -11							
Mechanical	Weight (typ)	g	280							
	Size (W x H x D)	mm	26.5 x 82 x 120 (Refer to outline drawing)							

(*1) Output voltage might be unstable when start up at -40 to -10°C and no load. In that case, apply minimum output current.

(*2) At 100/200VAC, Ta=25°C and maximum output power.

(*3) For cases where conformance to various safety specs (UL, CSA, EN) are required, to be described as 100 - 240VAC (50/60Hz).

(*4) Not applicable for the in-rush current to noise filter for less than 0.2ms.

(*5) Measure with JEITA RC-9131A probe, bandwidth of scope :100MHz.

(*6) 85 - 265VAC, constant load.

(*7) No load-Full load, constant input voltage.

(*8) Constant current limit and hiccup with automatic recovery. Not operate at over load or dead short condition for more than 30 seconds.

(*9) OVP circuit will shutdown output, manual reset (re power on).

(*10) At 100/200VAC, nominal output voltage and maximum output current.

(*11) Measured by the each measuring method of UL, CSA, EN and DENAN (at 60Hz).

(*12) Ratings - Derating at standard mounting.
 - Load (%) is percent of maximum output power or maximum output current, whichever is greater.
 - As for other mountings, refer to derating curve.
 - For conditions of start up at -40°C to -10°C, refer to derating curve.

(*13) Category 4 exposure levels : Track transportation over U.S. highways, composite two-wheeled trailer.

(*14) As for DENAN, dsigned to meet at 100VAC.

● Recommended EMC Filter

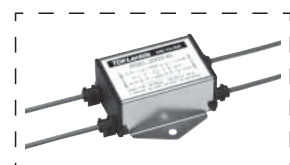

RSEL-2001W

Please refer to "TDK-Lambda EMC Filters" catalog.

Outline Drawing

[HWS50/HD]

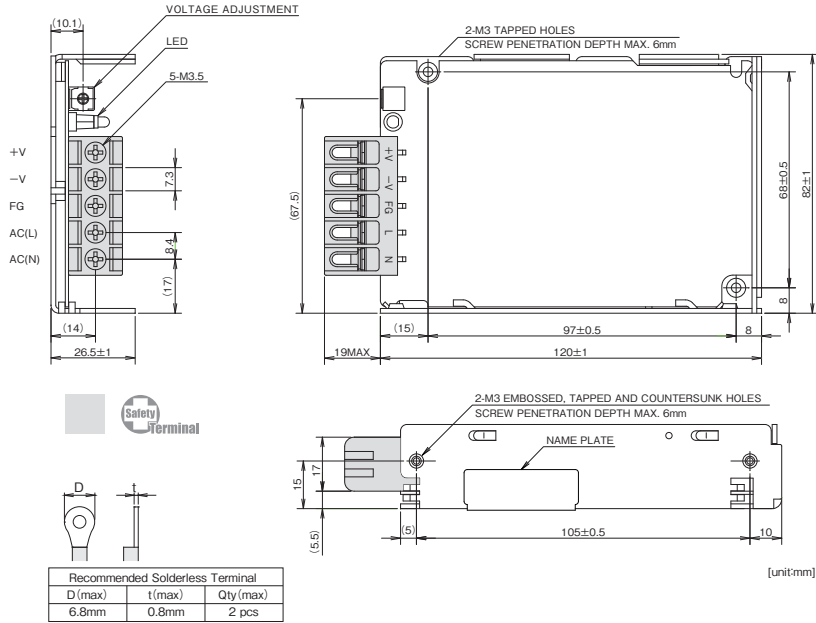

Output Derating

OUTPUT DERATING CURVE

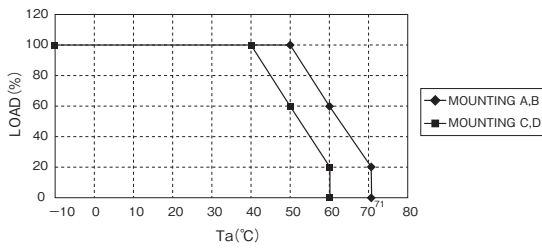

*COOLING : CONVECTION COOLING

Ta(°C)	LOAD(%)	
	MOUNTING A, B	MOUNTING C, D
-10 to +40	100	100
50	100	60
60	60	20
71	20	-

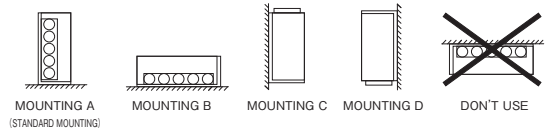

Start-up condition at low temperature

●DERATING TO START UP AT Ta : -30 to -10°C

Input Voltage (VAC)	LOAD(%)	
	Normal start up.	Stable output after 1 min from start up.
85	80	100
170	100	100

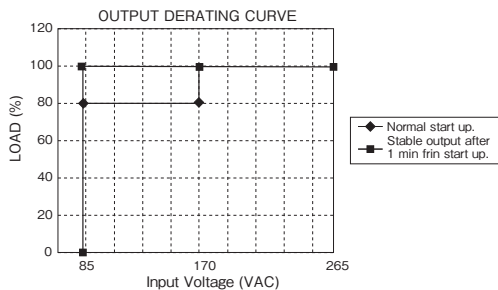

●DERATING TO START UP AT Ta : -40 to -10°C

Input Voltage (VAC)	LOAD(%)	
	Normal start up.	Stable output after 3 min from start up.
90	30	50
170	30	50

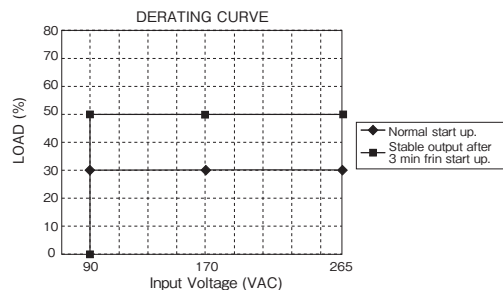

=NOTES=

- *At Ta : -30 to -10°C.
- *Output voltage : Nominal output voltage.
- *Input voltage : Not gradual start up.
- *Do not use the load that is constant current mode.
- *Avoid forced air cooling. It is assumed that inside of power supply is heated by self-heating within 1 minutes.
- *No dewdrop.
- *Output voltage might be unstable at no load. In that case, apply minimum output current.
- *Pay attention to above items before using the unit. Incorrect usage could lead to unstable output voltage.

=NOTES=

- *At Ta : -40 to -10°C.
- *Output voltage : Nominal output voltage.
- *Input voltage : Not operate at 85 - 90VAC, and not gradual start up.
- *Do not use the load that is constant current mode.
- *Avoid forced air cooling. It is assumed that inside of power supply is heated by self-heating within 3 minutes.
- *No dewdrop.
- *Output voltage might be unstable at no load. In that case, apply minimum output current.
- *Pay attention to above items before using the unit. Incorrect usage could lead to unstable output voltage.

HWS100/HD Specifications (Read instruction manual carefully, before using the power supply unit.)

ITEMS/UNITS		MODEL	HWS100-3/HD	HWS100-5/HD	HWS100-12/HD	HWS100-15/HD	HWS100-24/HD	HWS100-48/HD
Input	Voltage Range (*3)	V	AC85 - 265 or DC120 - 370					
	Frequency (*3)	Hz	47 - 63					
	Power Factor (100/200VAC)(typ) (*2)		0.98 / 0.90		0.99 / 0.95			
	Efficiency (100/200VAC)(typ) (*2)	%	78 / 81		83 / 86		84 / 87	
	Current (100/200VAC)(typ) (*2)	A	0.9 / 0.45		1.3 / 0.65			
	Inrush Current (100/200VAC)(typ) (*4)	A	14 / 28, Ta=25°C, cold start					
	Leakage Current (*11)	mA	Less than 0.5. (0.2 (typ) at 100VAC / 0.4 (typ) at 230VAC)					
Output	Nominal Voltage	VDC	3.3	5	12	15	24	48
	Minimum Current (*1)	A	0.2		0.09	0.07	0.05	0.02
	Maximum Current	A	20		8.5	7	4.5	2.1
	Maximum Power	W	66	100	102	105	108	100.8
	Maximum Line Regulation (*6)	mV	20		48	60	96	192
	Maximum Load Regulation (*7)	mV	40		96	120	192	384
	Temperature Coefficient		Less than 0.02% / °C					
	Maximum Ripple & Noise (0≤Ta≤71°C) (*5)	mVp-p	120		150		200	
	Maximum Ripple & Noise (-10≤Ta< 0°C) (*5)	mVp-p	160		180		240	
	Hold-up Time (typ) (*10)	ms	20					
	Function	Voltage Adjustable Range	VDC	2.97 - 3.96	4.0 - 6.0	9.6 - 14.4	12.0 - 18.0	19.2 - 28.8
Over Current Protection (*8)		A	>21.0		>8.92	>7.35	>4.72	>2.20
Over Voltage Protection (*9)		VDC	4.13 - 4.95	6.25 - 7.25	15.0 - 17.4	18.8 - 21.8	30.0 - 34.8	55.2 - 64.8
Remote Sensing			Possible					
Parallel Operation			-					
Series Operation			Possible					
Line DIP			Designed to meet SEMI-F47 (200VAC Line only)					
Operating Temperature (*12)		°C	-10 to +71 (-10 to +50: 100%, +60: 60%, +71: 20%) Guarantee start up at -40 to -10					
Storage Temperature		°C	-40 to +85					
Operating Humidity		%RH	30 - 90 (No dewdrop)					
Environment	Storage Humidity	%RH	10 - 95 (No dewdrop)					
	Vibration (*13)		At no operating, 10~55Hz (sweep for 1min) 19.6m/s ² constant, X, Y, Z 1hour each. Designed to meet MIL-STD-810F 514.5 Category 4, 10					
	Shock (In package)		Less than 196.1m/s ² Designed to meet MIL-STD-810F 516.5 Procedure I, VI					
	Cooling		Convection cooling					
	Withstand Voltage		Input - FG : 2kVAC (20mA), Input - Output : 3kVAC (20mA) Output - FG : 500VAC (100mA) for 1min					
	Isolation Resistance		More than 100MΩ at 25°C and 70%RH Output - FG : 500VDC					
Standards	Safety Standards (*14)		Approved by UL60950-1, CSA C22.2 No.60950-1, EN60950-1, EN50178 Designed to meet UL508, DENAN					
	PFHC		Designed to meet IEC61000-3-2					
	EMI		Designed to meet EN55011/EN55022-B, FCC-B, VCCI-B					
	Immunity		Designed to meet IEC61000-4-2(Level 2,3), -3(Level 3), -4(Level 3), -5(Level 3,4), -6(Level 3), -8(Level 4), -11					
Mechanical	Weight (typ)	g	450					
	Size (W x H x D)	mm	28 x 82 x 160 (Refer to outline drawing)					

(*1) Output voltage might be unstable when start up at -40 to -10°C and no load. In that case, apply minimum output current.

(*2) At 100/200VAC, Ta=25°C and maximum output power.

(*3) For cases where conformance to various safety specs (UL, CSA, EN) are required, to be described as 100 - 240VAC (50/60Hz).

(*4) Not applicable for the in-rush current to noise filter for less than 0.2ms.

(*5) Measure with JEITA RC-9131A probe, bandwidth of scope :100MHz.

(*6) 85 - 265VAC, constant load.

(*7) No load-full load, constant input voltage.

(*8) Constant current limit and hiccup with automatic recovery.
Not operate at over load or dead short condition for more than 30 seconds.

(*9) OVP circuit will shutdown output, manual reset (re power on).

(*10) At 100/200VAC, nominal output voltage and maximum output current.

(*11) Measured by the each measuring method of UL, CSA, EN and DENAN (at 60Hz).

(*12) Ratings - Derating at standard mounting.
- Load (%) is percent of maximum output power or maximum output current, whichever is greater.
- As for other mountings, refer to derating curve.
- For conditions of start up at -40°C to -10°C, refer to derating curve.

(*13) Category 4 exposure levels : Track transportation over U.S. highways, composite two-wheeled trailer.

(*14) As for DENAN, designed to meet at 100VAC.

● Recommended EMC Filter

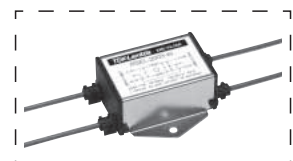

RSEL-2002W

Please refer to "TDK-Lambda EMC Filters" catalog.

Outline Drawing

[HWS100/HD]

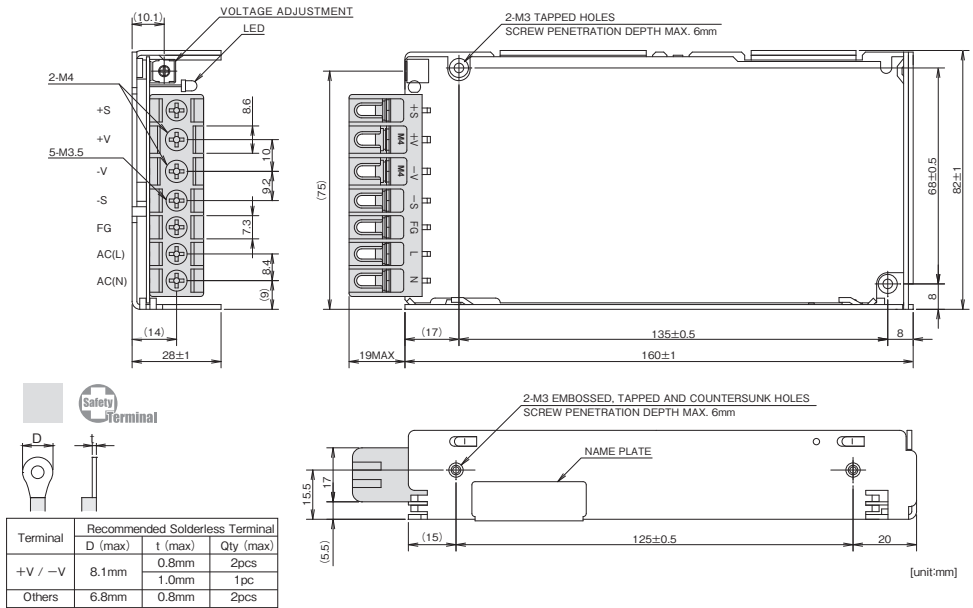

Output Derating

OUTPUT DERATING CURVE

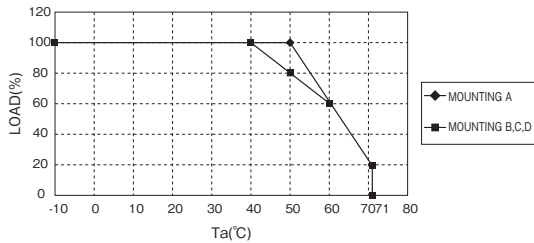

*COOLING : CONVECTION COOLING

Ta(°C)	LOAD(%)	
	MOUNTING A	MOUNTING B, C, D
-10 to +40	100	100
50	100	80
60	60	60
71	20	20

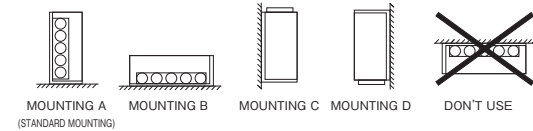

Start-up condition at low temperature

●DERATING TO START UP AT Ta : -30 to -10°C

Input Voltage (VAC)	LOAD(%)	
	Normal start up.	Stable output after 1 min from start up.
85	70	100
170	100	100

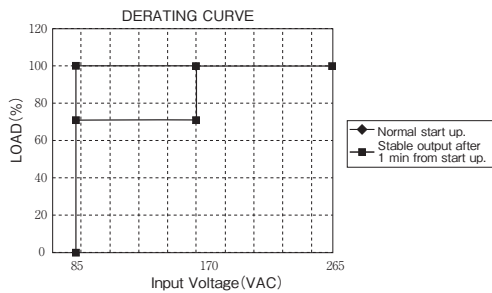

=NOTES=

- *At Ta : -30 to -10°C .
- *Output voltage : Nominal output voltage.
- *Input voltage : Not gradual start up.
- *Do not use the load that is constant current mode.
- *Avoid forced air cooling. It is assumed that inside of power supply is heated by self-heating within 1 minutes.
- *No dewdrop.
- *Output voltage might be unstable at no load. In that case, apply minimum output current.
- *Pay attention to above items before using the unit. Incorrect usage could lead to unstable output voltage.

●DERATING TO START UP AT Ta : -40 to -10°C

Input Voltage (VAC)	LOAD(%)	
	Normal start up.	Stable output after 3 min from start up.
90	30	60
170	50	70

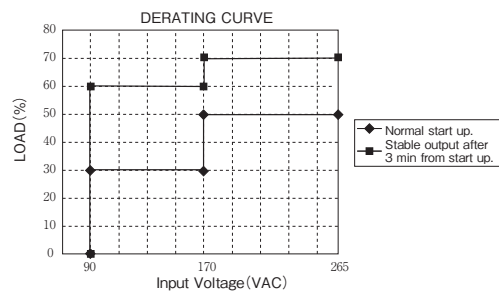

=NOTES=

- *At Ta : -40 to -10°C .
- *Output voltage : Nominal output voltage.
- *Input voltage : Not operate at 85 - 90VAC, and not gradual start up.
- *Do not use the load that is constant current mode.
- *Avoid forced air cooling. It is assumed that inside of power supply is heated by self-heating within 3 minutes.
- *No dewdrop.
- *Output voltage might be unstable at no load. In that case, apply minimum output current.
- *Pay attention to above items before using the unit. Incorrect usage could lead to unstable output voltage.

HWS150/HD Specifications (Read instruction manual carefully, before using the power supply unit.)

ITEMS/UNITS		MODEL	HWS150-3/HD	HWS150-5/HD	HWS150-12/HD	HWS150-15/HD	HWS150-24/HD	HWS150-48/HD
Input	Voltage Range (*3)	V	AC85 - 265 or DC120 - 370					
	Frequency (*3)	Hz	47 - 63					
	Power Factor (100/200VAC)(typ) (*2)		0.98 / 0.90		0.99 / 0.95			
	Efficiency (100/200VAC)(typ) (*2)	%	78 / 81		83 / 86		85 / 88	
	Current (100/200VAC)(typ) (*2)	A	1.3 / 0.65		1.9 / 0.95			
	Inrush Current (100/200VAC)(typ) (*4)	A	14 / 28, Ta=25°C, cold start					
Leakage Current (*11)	mA	Less than 0.5. (0.2 (typ) at 100VAC / 0.4 (typ) at 230VAC)						
Output	Nominal Voltage	VDC	3.3	5	12	15	24	48
	Minimum Current (*1)	A	0.3		0.1		0.07	0.03
	Maximum Current	A	30		13	10	6.5	3.3
	Maximum Power	W	99	150	156	150	156	158.4
	Maximum Line Regulation (*6)	mV	20		48	60	96	192
	Maximum Load Regulation (*7)	mV	40		96	120	192	384
	Temperature Coefficient		Less than 0.02% / °C					
	Maximum Ripple & Noise (0≤Ta≤71°C) (*5)	mVp-p	120		150			200
	Maximum Ripple & Noise (-10≤Ta< 0°C) (*5)	mVp-p	160		180			240
	Hold-up Time (typ) (*10)	ms	20					
	Function	Voltage Adjustable Range	VDC	2.97 - 3.96	4.0 - 6.0	9.6 - 14.4	12.0 - 18.0	19.2 - 28.8
Over Current Protection (*8)		A	>31.5		>13.6	>10.5	>6.82	>3.46
Over Voltage Protection (*9)		VDC	4.13 - 4.95	6.25 - 7.25	15.0 - 17.4	18.8 - 21.8	30.0 - 34.8	55.2 - 64.8
Remote Sensing			Possible					
Parallel Operation			-					
Series Operation			Possible					
Line DIP			Designed to meet SEMI-F47 (200VAC Line only)					
Environment	Operating Temperature (*12)	°C	-10 to +71 (-10 to +50: 100%, +60: 60%, +71: 20%) Guarantee start up at -40 to -10					
	Storage Temperature	°C	-40 to +85					
	Operating Humidity	%RH	30 - 90 (No dewdrop)					
	Storage Humidity	%RH	10 - 95 (No dewdrop)					
	Vibration (*13)		At no operating, 10 - 55Hz (sweep for 1min) 19.6m/s ² constant, X, Y, Z 1hour each. Designed to meet MIL-STD-810F 514.5 Category 4, 10					
	Shock (In package)		Less than 196.1m/s ² Designed to meet MIL-STD-810F 516.5 Procedure I, VI					
	Cooling		Convection cooling					
Isolation	Withstand Voltage		Input - FG : 2kVAC (20mA), Input - Output : 3kVAC (20mA) Output - FG : 500VAC (100mA) for 1min					
	Isolation Resistance		More than 100MΩ at 25°C and 70%RH Output - FG : 500VDC					
Standards	Safety Standards (*14)		Approved by UL60950-1, CSA C22.2 No.60950-1, EN60950-1, EN50178 Designed to meet UL508, DENAN					
	PFHC		Designed to meet IEC61000-3-2					
	EMI		Designed to meet EN55011/EN55022-B, FCC-B, VCCI-B					
	Immunity		Designed to meet IEC61000-4-2(Level 2,3), -3(Level 3), -4(Level 3), -5(Level 3,4), -6(Level 3), -8(Level 4), -11					
Mechanical	Weight (typ)	g	500					
	Size (W x H x D)	mm	37 x 82 x 160 (Refer to outline drawing)					

(*1) Output voltage might be unstable when start up at -40 to -10°C and no load. In that case, apply minimum output current.

(*2) At 100/200VAC, Ta=25°C and maximum output power.

(*3) For cases where conformance to various safety specs (UL, CSA, EN) are required, to be described as 100 - 240VAC (50/60Hz).

(*4) Not applicable for the in-rush current to noise filter for less than 0.2ms.

(*5) Measure with JEITA RC-9131A probe, bandwidth of scope : 100MHz.

(*6) 85 - 265VAC, constant load.

(*7) No load-Full load, constant input voltage.

(*8) Constant current limit and hiccup with automatic recovery.
Not operate at over load or dead short condition for more than 30 seconds.

(*9) OVP circuit will shutdown output, manual reset (re power on).

(*10) At 100/200VAC, nominal output voltage and maximum output current.

(*11) Measured by the each measuring method of UL, CSA, EN and DENAN (at 60Hz).

(*12) Ratings - Derating at standard mounting.
- Load (%) is percent of maximum output power or maximum output current, whichever is greater.
- As for other mountings, refer to derating curve.
- For conditions of start up at -40°C to -10°C, refer to derating curve.

(*13) Category 4 exposure levels : Track transportation over U.S. highways, composite two-wheeled trailer.

(*14) As for DENAN, designed to meet at 100VAC.

● Recommended EMC Filter

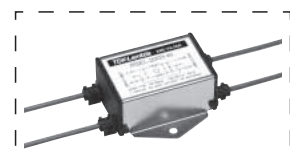

RSEL-2003W

Please refer to "TDK-Lambda EMC Filters" catalog.

Outline Drawing

[HWS150/HD]

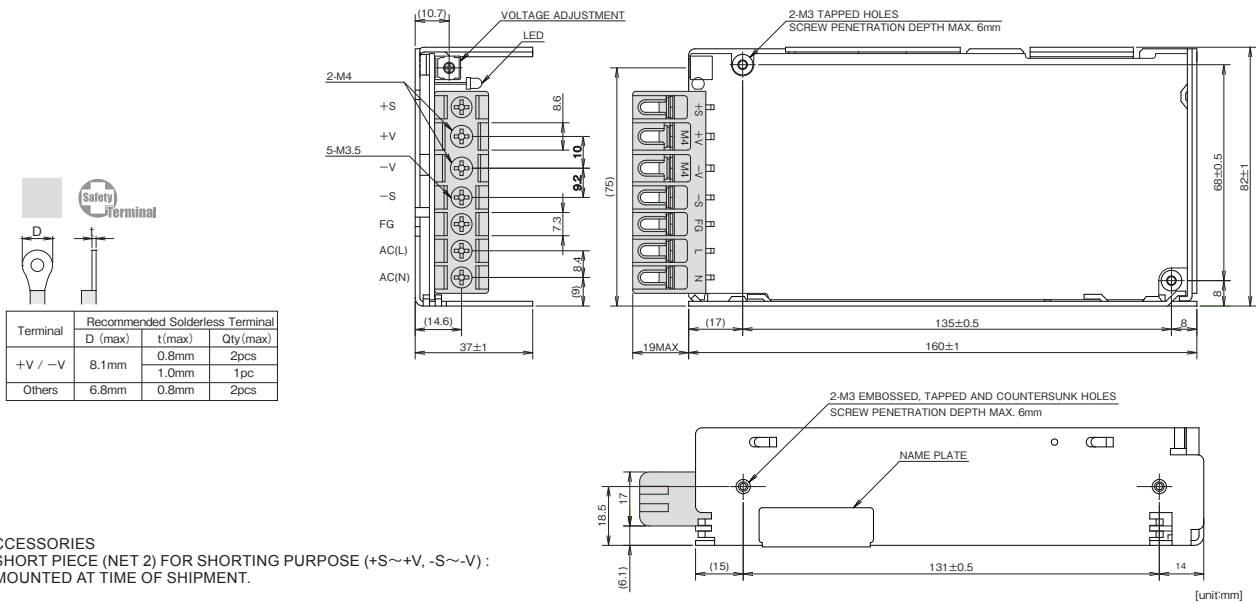

Output Derating

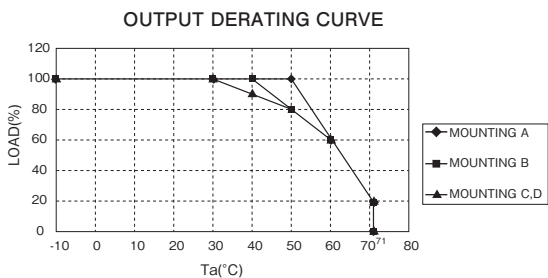

***COOLING : CONVECTION COOLING**

Ta(°C)	LOAD(%)		
	MOUNTING A	MOUNTING B	MOUNTING C, D
-10 to +30	100	100	100
40	100	100	90
50	100	80	80
60	60	60	60
71	20	20	20

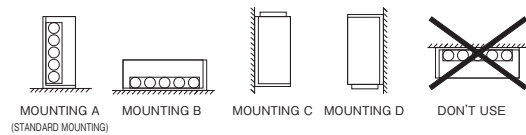

Start-up condition at low temperature

●DERATING TO START UP AT Ta : -30 to -10°C

Input Voltage (VAC)	LOAD(%)	
	Normal start up.	Stable output after 1 min from start up.
85	80	100
170	100	100

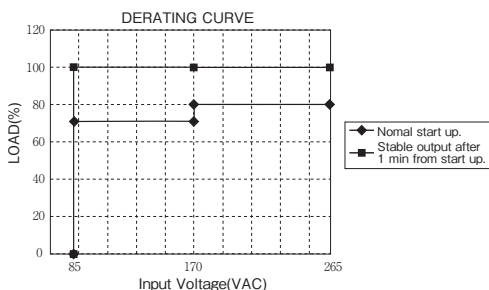

- =NOTES=
 *At Ta : -30 to -10°C.
 *Output voltage : Nominal output voltage.
 *Input voltage : Not gradual start up.
 *Do not use the load that is constant current mode.
 *Avoid forced air cooling. It is assumed that inside of power supply is heated by self-heating within 1 minutes.
 *No dewdrop.
 *Output voltage might be unstable at no load. In that case, apply minimum output current.
 *Pay attention to above items before using the unit. Incorrect usage could lead to unstable output voltage.

●DERATING TO START UP AT Ta : -40 to -10°C

Input Voltage (VAC)	LOAD(%)	
	Normal start up.	Stable output after 3 min from start up.
90	-	20
170	10	40

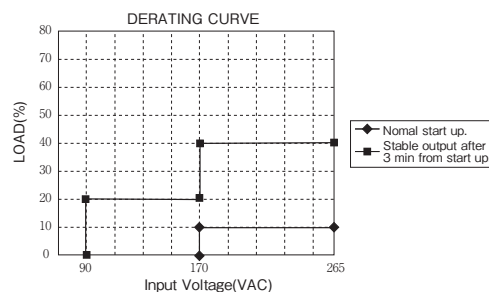

- =NOTES=
 *At Ta : -40 to -10°C.
 *Output voltage : Nominal output voltage.
 *Input voltage : Not operate at 85 - 90VAC, and not gradual start up.
 *Do not use the load that is constant current mode.
 *Avoid forced air cooling. It is assumed that inside of power supply is heated by self-heating within 3 minutes.
 *No dewdrop.
 *Output voltage might be unstable at no load. In that case, apply minimum output current.
 *Pay attention to above items before using the unit. Incorrect usage could lead to unstable output voltage.

HWS300/HD Specifications (Read instruction manual carefully, before using the power supply unit.)

ITEMS/UNITS		MODEL	HWS300-3/HD	HWS300-5/HD	HWS300-12/HD	HWS300-15/HD	HWS300-24/HD	HWS300-48/HD	
Input	Voltage Range (*3)	V	AC85 - 265 or DC120 - 330						
	Frequency (*3)	Hz	47 - 63						
	Power Factor (100/200VAC)(typ) (*2)		0.99 / 0.95						
	Efficiency (100/200VAC)(typ) (*2)	%	74 / 77	79 / 82	80 / 83		82 / 85		
	Current (100/200VAC)(typ) (*2)	A	2.7 / 1.4	3.8 / 1.9	4.1 / 2.1				
	Inrush Current (100/200VAC)(typ) (*4)	A	20 / 40						
	Leakage Current (*11)	mA	Less than 0.75. (0.2 (typ) at 100VAC / 0.44 (typ) at 230VAC)						
Output	Nominal Voltage	VDC	3.3	5	12	15	24	48	
	Maximum Current (*1)	A	60		27	22	14 (16.5)		
	Maximum Power	W	198	300	324	330	336		
	Maximum Line Regulation (*6)	mV	20		48	60	96	192	
	Maximum Load Regulation (*7)	mV	30		72	90	144	288	
	Temperature Coefficient		Less than 0.02% / °C						
	Maximum Ripple & Noise (0≤Ta≤70°C) (*5)	mVp-p	120		150		350		
	Maximum Ripple & Noise (-10≤Ta< 0°C) (*5)	mVp-p	180		200		400		
	Hold-up Time (typ) (*10)	ms	20						
	Voltage Adjustable Range	VDC	2.64-3.96	4.0-6.0	9.6-14.4	12.0-18.0	19.2-28.8	38.4-52.8	
Function	Over Current Protection (*8)	A	>63	>63	>28.4	>23.1	>16.7	>7.4	
	Over Voltage Protection (*9)	VDC	4.13-4.95	6.25-7.25	15.0-17.4	18.8-21.8	30.0-34.8	55.2-64.8	
	Remote Sensing		Possible						
	Remote ON/OFF Control		Possible						
	Parallel Operation		Possible						
	Series Operation		Possible						
	Monitoring Signal		PF (Open collector output)						
	Line DIP		Designed to meet SEMI-F47 (200VAC Line only)						
	Environment	Operating Temperature (*12)(*13)	°C	-10 to +71 (-10 to +50: 100%, +71: 50%) Guarantee Start up at -40 to -10					
		Storage Temperature	°C	-40 to +85					
Operating Humidity		%RH	10 - 90 (No dewdrop)						
Storage Humidity		%RH	10 - 95 (No dewdrop)						
Vibration (*14)			At no operating, 10 - 55Hz (sweep for 1min) 19.6m/s² constant, X, Y, Z 1hour each. Designed to meet MIL-STD-810F 514.5 Category 4,10						
Shock (In package)			Less than 196.1m/s² Designed to meet MIL-STD-810F 516.5 Procedure I, VI						
Cooling			Forced air by blower fan						
Isolation	Withstand Voltage		Input - FG : 2.5kVAC (20mA), Input - Output : 3kVAC (20mA) Output - FG: 500VAC (100mA), Output-CNT: 100VAC(100mA) for 1min						
	Isolation Resistance		More than 100MΩ Output - FG : 500VDC More than 10MΩ Output -CNT : 100VDC at 25°C and 70%RH						
Standards	Safety Standards (*15)		Approved by UL60950-1, CSA C22.2 No.60950-1, EN60950-1, EN50178 Designed to meet DENAN						
	PFHC		Designed to meet IEC61000-3-2						
	EMI		Designed to meet EN55011/EN55022-B, FCC-B, VCCI-B						
Mechanical	Immunity		Designed to meet IEC61000-4-2(Level 2,3), -3(Level 3), -4(Level 3), -5(Level 3,4), -6(Level 3), -8(Level 4), -11						
	Weight (typ)	g	1000						
	Size (W x H x D)	mm	61 x 82 x 165 (Refer to outline drawing)						

- (*1) () : Peak output current at 200VAC. Operating time at peak output is less than 10sec, duty is less than 35%.
- (*2) At 100/200VAC, Ta=25°C and maximum output power.
- (*3) For cases where conformance to various safety specs (UL, CSA, EN) are required, to be described as 100 - 240VAC (50/60Hz).
- (*4) Not applicable for the in-rush current to noise filter for less than 0.2ms.
- (*5) Measure with JEITA RC-9131A probe, bandwidth of scope :100MHz.
- (*6) 85 - 265VAC, constant load.
- (*7) No load-Full load, constant input voltage.
- (*8) 3.3, 5V model: Constant current limit and hiccup with automatic recovery.
12 - 48V model: Constant current limit with automatic recovery.
Avoid to operate at over load or short circuit condition for more than 30 seconds.
- (*9) OVP circuit will shut the output down, manual reset (CNT reset or re power on).
- (*10) At 100/200VAC, nominal output voltage and maximum output current.
- (*11) Measured by the each measuring method of UL, CSA, EN and DENAN (at 60Hz), Ta=25°C.
- (*12) Ratings - Derating at standard mounting. Refer to output derating curve.
- Load (%) is percent of maximum output power or maximum output current, whichever is greater.
- (*13) For -40°C to -10°C need 3minutes to stabilize the output voltage.
- (*14) Category 4 exposure levels : Truck transportation over U.S. highways, composite two-wheeled trailer.
- (*15) As for DENAN, designed to meet at 100VAC.

● Recommended EMC Filter

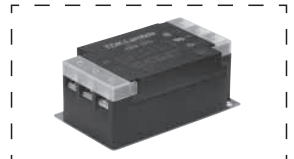

RSEN-2006
Please refer to "TDK-Lambda EMC Filters" catalog.

HWS

HWS HD

HWS ME

HWS-P

Instruction Manual

Outline Drawing

[HWS300/HD]

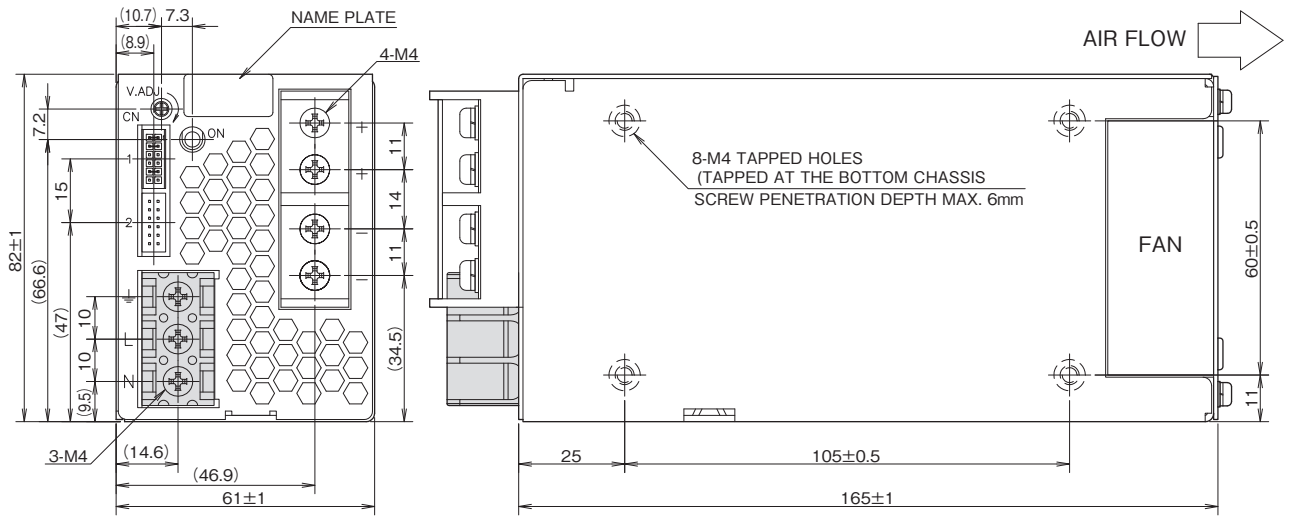

== NOTES ==

- A: MODEL NAME, NOMINAL OUTPUT VOLTAGE AND MAXIMUM OUTPUT CURRENT ARE SHOWN IN THE NAME PLATE IN ACCORDANCE WITH THE SPECIFICATIONS.
- B: M4 TAPPED HOLES (8) FOR CUSTOMER CHASSIS MOUNTING.(SCREW PENETRATION DEPTH 6mm MAX.)

== ACCESSORIES ==

- * COVER FOR BARRIER TERMINAL STRIP -----1 (ATTACHED ON TERMINAL AT SHIPMENT)
- * SHORT PIECE -----1 SHORTING +Vm +S, -Vm -S, CNT TOG (ATTACHED ON CN1 AT SHIPMENT)

== SIGNAL CONNECTOR USED ==

PART DESCRIPTION	PART NAME
PIN HEADER	S12B-PHDS5

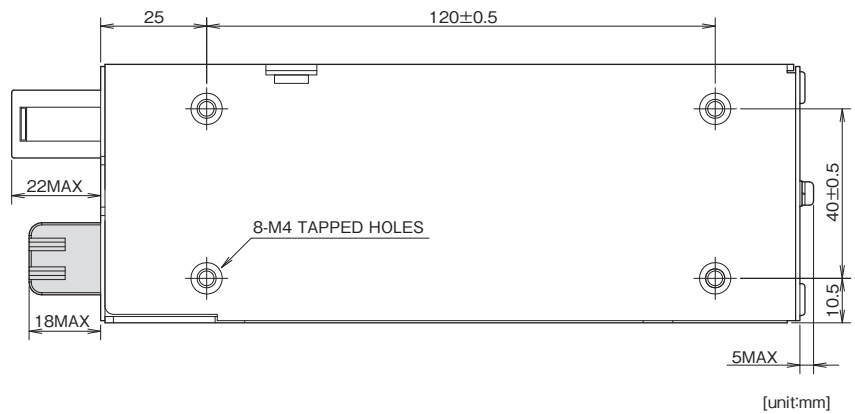

== MATCHING HOUSINGS , PINS & TOOL ==

PART DESCRIPTION	PART NAME	MANUFACT
SOCKET HOUSING	PHDR-12VS	JST
TERMINAL PINS	SPHD-002T-P0.5(AWG28-24) SPHD-001T-P0.5(AWG26-22)	JST
HAND CRIMPING TOOL	YRS-620(SPHD-002T-P0.5) YC-610R(SPHD-001T-P0.5)	JST

Output Derating

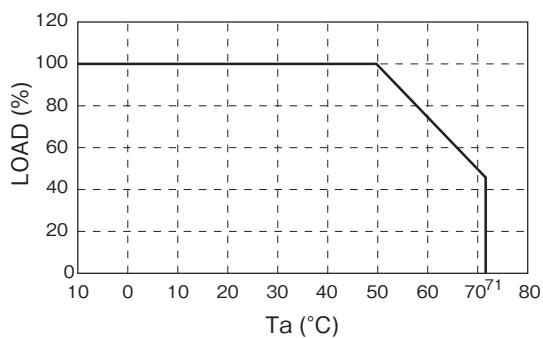

Ta(°C)	LOAD(%)	
	MOUNTING A	MOUNTING B
-10 to +50	100	
71	50	

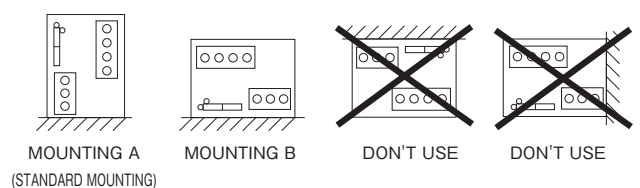

HWS600/HD Specifications (Read instruction manual carefully, before using the power supply unit.)

ITEMS/UNITS		MODEL	HWS600-3/HD	HWS600-5/HD	HWS600-12/HD	HWS600-15/HD	HWS600-24/HD	HWS600-48/HD
Input	Voltage Range (*3)	V	AC85 - 265 or DC120 - 330					
	Frequency (*3)	Hz	47 - 63					
	Power Factor (100/200VAC)(typ) (*2)		0.99 / 0.95					
	Efficiency (100/200VAC)(typ) (*2)	%	75 / 78	80 / 83		81 / 84	82 / 85	83 / 86
	Current (100/200VAC)(typ) (*2)	A	5.4 / 2.6	7.5 / 3.6		8.1 / 3.9		
	Inrush Current (100/200VAC)(typ) (*4)	A	20 / 40					
	Leakage Current (*11)	mA	Less than 0.75. (0.2 (typ) at 100VAC / 0.44 (typ) at 230VAC)					
Output	Nominal Voltage	VDC	3.3	5	12	15	24	48
	Maximum Current (*1)	A	120		53	43	27 (31)	13
	Maximum Power	W	396	600	636	645	648	624
	Maximum Line Regulation (*6)	mV	20		48	60	96	192
	Maximum Load Regulation (*7)	mV	30		72	90	144	288
	Temperature Coefficient		Less than 0.02% / °C					
	Maximum Ripple & Noise (0<Ta<70°C) (*5)	mVp-p	120		150		350	
	Maximum Ripple & Noise (-10≤Ta< 0°C) (*5)	mVp-p	180		200		400	
	Hold-up Time (typ) (*10)	ms	20					
	Voltage Adjustable Range	VDC	2.64-3.96	4.0-6.0	9.6-14.4	12.0-18.0	19.2-28.8	38.4-52.8
Function	Over Current Protection (*8)	A	>126		>55.7	>45.2	>31.4	>13.7
	Over Voltage Protection (*9)	VDC	4.13-4.95	6.25-7.25	15.0-17.4	18.8-21.8	30.0-34.8	55.2-64.8
	Remote Sensing		Possible					
	Remote ON/OFF Control		Possible					
	Parallel Operation		Possible					
	Series Operation		Possible					
	Monitoring Signal		PF (Open Collector Output)					
Line DIP		Designed to meet SEMI-F47 (200VAC Line only)						
Environment	Operating Temperature (*12)(*13)	°C	-10 to +71 (-10 to +50: 100%, +71: 50%) Guarantee start up at -40 to -10					
	Storage Temperature	°C	-40 to +85					
	Operating Humidity	%RH	10 - 90%RH (No dewdrop)					
	Storage Humidity	%RH	10 - 95%RH (No dewdrop)					
	Vibration (*14)		At no operating, 10 - 55Hz (sweep for 1min) 19.6m/s ² constant, X, Y, Z 1hour each. Designed to meet MIL-STD-810F 514.5 Category 4, 10					
	Shock (In package)		Less than 196.1m/s ² Designed to meet MIL-STD-810F 516.5 Procedure I, VI					
Isolation	Withstand Voltage		Input - FG : 2.5kVAC (20mA), Input - Output : 3kVAC (20mA) Output - FG : 500VAC (100mA), Output - CNT : 100VAC(100mA) for 1min					
	Isolation Resistance		More than 100MΩ Output - FG : 500VDC More than 10MΩ Output - CNT : 100VDC at 25°C and 70%RH					
Standards	Safety Standards (*15)		Approved by UL60950-1, CSA C22.2 No 60950-1, EN60950-1, EN50178 Designed to meet DENAN					
	PFHC		Designed to meet IEC61000-3-2					
	EMI		Designed to meet EN55011/EN55022-B, FCC-B, VCCI-B					
	Immunity		Designed to meet IEC61000-4-2(Level 2,3), -3(Level 3), -4(Level 3), -5(Level 3,4), -6(Level 3), -8(Level 4), -11					
Mechanical	Weight (typ)	g	1600					
	Size (W x H x D)	mm	100 x 82 x 165 (Refer to outline drawing)					

(*1) () : Peak output current at 200VAC. Operating time at peak output is less than 10sec, duty is less than 35%.

(*2) At 100/200VAC, Ta=25°C and maximum output power.

(*3) For cases where conformance to various safety specs (UL, CSA, EN) are required, to be described as 100 - 240VAC (50/60Hz).

(*4) Not applicable for the in-rush current to noise filter for less than 0.2ms. Inrush Current is 30A (typ) when PFHC start-up.

(*5) Measure with JEITA RC-9131A probe, bandwidth of scope : 100MHz.

(*6) 85 - 265VAC, constant load.

(*7) No load - Full load, constant input voltage.

(*8) 3V and 5V model: Constant current limit and hiccup with automatic recovery.
12 - 48V model: Constant current limit with automatic recovery.
Avoid to operate at over load or short circuit condition for more than 30 seconds.

(*9) OVP circuit will shut the output down, manual reset (CNT reset or Re-power on).

(*10) At 100/200VAC, nominal output voltage and maximum output current.

(*11) Measured by the each measuring method of UL, CSA, EN and DENAN (at 60Hz), Ta=25°C.

(*12) Ratings - Derating at standard mounting. Refer to output derating curve.
- Load (%) is percent of maximum output power or maximum output current, whichever is greater.

(*13) For -40°C to -10°C need 3 minutes to stabilize the output voltage.

(*14) Category 4 exposure levels : Truck transportation over U.S. highways, composite two-wheeled trailer.

(*15) As for DENAN, designed to meet at 100VAC.

● Recommended EMC Filter



RSEN-2016

Please refer to "TDK-Lambda EMC Filters" catalog.

Outline Drawing

[HWS600/HD]

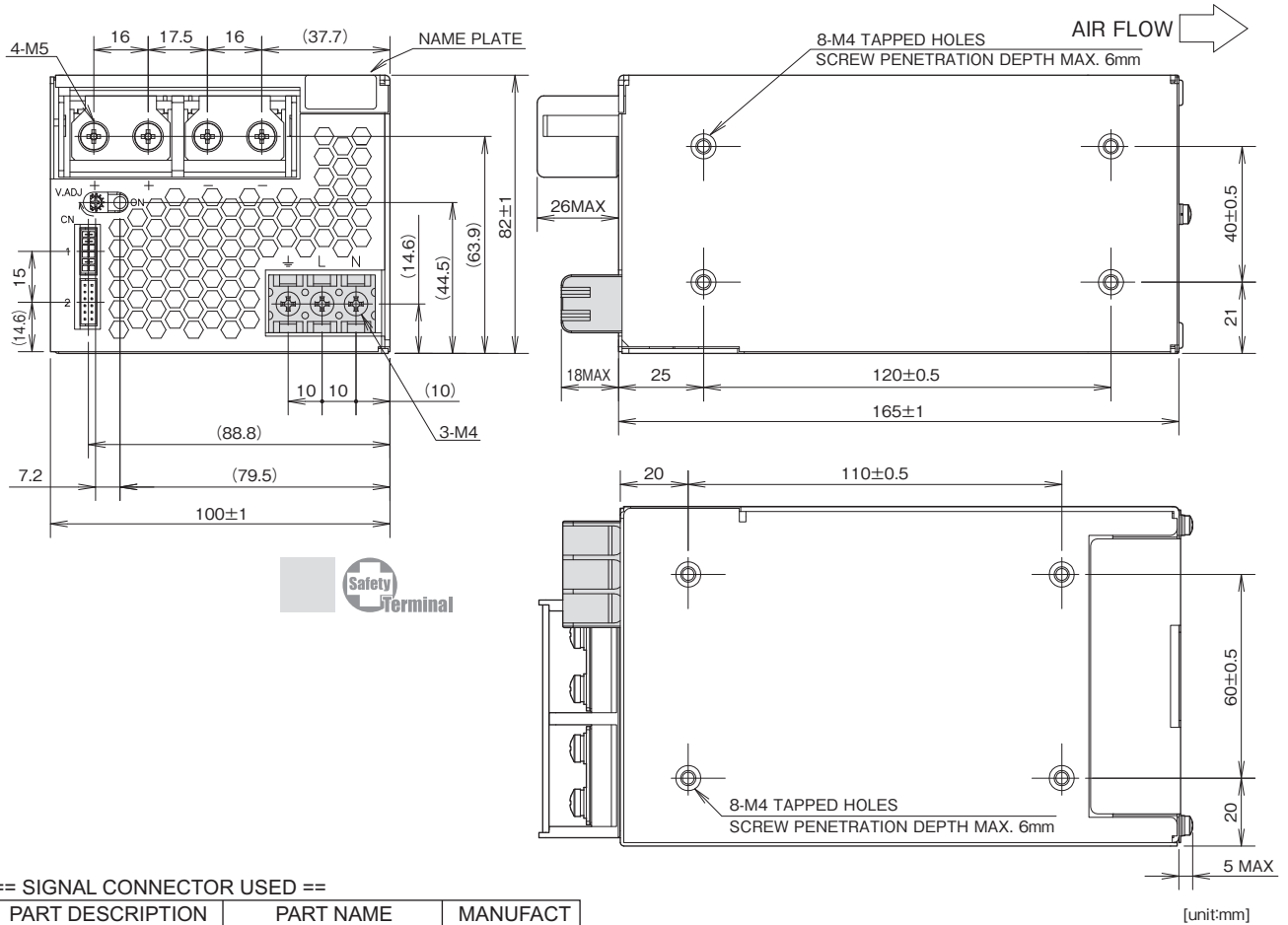

== SIGNAL CONNECTOR USED ==

PART DESCRIPTION	PART NAME	MANUFACT
PIN HEADER	S12B-PHDSS	JST

== MATCHING HOUSINGS, PINS & TOOL ==

PART DESCRIPTION	PART NAME	MANUFACT
SOCKET HOUSING	PHDR-12VS	JST
TERMINAL PINS	SPHD-002T-P0.5(AWG28~24) SPHD-001T-P0.5(AWG26~22)	JST
HAND CRIMPING TOOL	YRS-620(SPHD-002T-P0.5) YC-610R(SPHD-001T-P0.5)	JST

== ACCESSORIES ==

- * COVER FOR BARRIER TERMINAL STRIP -----1 (ATTACHED ON TERMINAL AT SHIPMENT)
- * SHORT PIECE -----1 SHORTING +Vm - +S, -Vm - -S, CNT TOG (ATTACHED ON CN1 AT SHIPMENT)

[unit:mm]

Output Derating

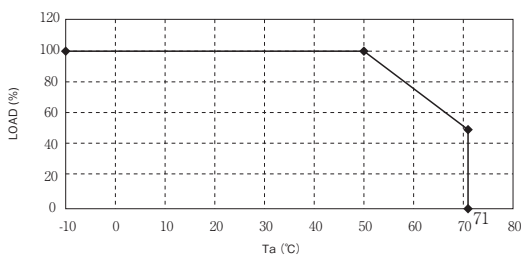

Ta (°C)	LOAD (%)	
	MOUNTING A	MOUNTING B
-10 to +50	100	100
71	50	50

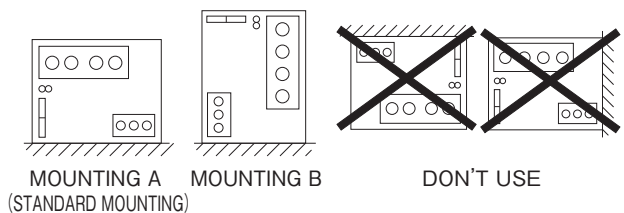

HWS1000/HD Specifications (Read instruction manual carefully, before using the power supply unit.)

ITEMS/UNITS		MODEL	HWS1000 -3/HD	HWS1000 -5/HD	HWS1000 -6/HD	HWS1000 -7/HD	HWS1000 -12/HD	HWS1000 -15/HD	HWS1000 -24/HD	HWS1000 -36/HD	HWS1000 -48/HD	HWS1000 -60/HD	
Input	Voltage Range (*2)	V	AC85 - 265 or DC120 - 330										
	Frequency (*2)	Hz	47 - 63										
	Power Factor (100/200VAC)(typ) (*1)		0.98/0.95										
	Efficiency (100/200VAC)(typ) (*1)	%	71/73	76/78	79/81	80/82	82/85	83/85	85/87	85/88	86/88	85/88	
	Current (100/200VAC)(typ) (*1)	A	9.6/5.0		13.5/7.0								
	Inrush Current (100/200VAC)(typ) (*3)	A	20/40										
	Leakage Current (100/240VAC)(*10)	mA	1.2 max										
Output	Nominal Voltage	VDC	3.3	5	6	7.5	12	15	24	36	48	60	
	Maximum Current	A	200		167	134	88	70	46	30.7	23	18.4	
	Maximum Peak Current (*13)	A	-		160	100	80	58.5	39	29.2	23.4		
	Maximum Power	W	660	1000	1002	1005	1056	1050	1104				
	Maximum Peak Power (*13)	W	-		1200			1404					
	Maximum Line Regulation (*5)	mV	20		36		48	60	96	144	192	240	
	Maximum Load Regulation (*6)	mV	40		60		100	120	150		300	360	
	Temperature Coefficient		Less than 0.02% / °C										
	Maximum	0 to +71°C	mVp-p		120		150			200		400	
	Ripple & Noise (*4)	-10 to 0°C	mVp-p		160		180			240	500	600	
	Hold-up Time (typ) (*9)	ms	20										
	Voltage Adjustable Range	VDC	2.64-3.96	4.0-6.0	4.8-7.2	6.0-9.0	9.6-14.4	12.0-18.0	19.2-28.8	28.8-43.2	38.4-52.8	48.0-66.0	
	Function	Over Current Protection (*7)	A	>210.0		>175.3	>168.0	>105.0	>84.0	>61.4	>40.9	>30.6	>24.5
Over Voltage Protection (*8)		VDC	4.12-4.62	6.25-7.0	7.5-8.4	9.37-10.5	15.0-17.4	18.7-21.8	30.0-34.8	45.0-49.7	55.2-60.0	69.0-75.0	
Remote Sensing			Possible										
Remote ON/OFF Control			Possible										
Parallel Operation			Possible										
Series Operation			Possible										
Monitoring Signal			PF(Open collector output)										
Line DIP			Built to meet SEMI-F47 (200VAC Line only)										
Other Function			PCB Coating on solder side and component side.										
Environment		Operating Temperature (*11)	°C	-10 to + 71, Guarantee Start up -40 to -10									
		-10 to +40°C	%										
		+50°C	83.9		100								
		+71°C	50										
	Storage Temperature	°C	-40 to +85										
	Operating Humidity	%RH	10 - 90 (No Condensing)										
	Storage Humidity	%RH	10 - 95 (No Condensing)										
Vibration (*14)(*15)		At no operating, 10 - 55Hz (Sweep for 1min.) 19.6m/s ² Constant, X,Y,Z 1hour each. Designed to meet MIL-STD-810F 514.5 Category 4 figure 514.5C-1, category 10											
Shock (In package) (*15)		Less than 196.1m/s ² Designed to meet MIL-STD-810F 516.5 Procedure I											
Cooling		Forced Air By Blower Fan											
Isolation	Withstand Voltage		Input - FG : 2kVAC (20mA), Input - Output : 3kVAC (20mA) Output - FG : 500VAC (300mA), (60V model 651VAC(390mA)), Output - CNT:100VAC (100mA) for 1min.										
	Isolation Resistance		More than 100MΩ Output - FG : 500VDC More than 10MΩ Output - CNT : 100VDC at 25°C and 70%RH										
Standards	Safety Standards (*12)		Approved by UL60950-1, CSA C22.2 No.60950-1, EN60950-1, EN50178. Built to meet DENAN.										
	PFHC		Built to meet IEC6100-3-2										
	EMI		Built to meet EN55011/EN55022-B, FCC-ClassB, VCCI-ClassB, CISPR-ClassB.										
Immunity		Built to meet IEC61000-4-2(Level 2,3), -3(Level 3), -4(Level 3), -5(Level 3,4), -6(Level 3), -8(Level 4), -11											
Mechanical	Weight (max)	g	3200										
	Size (W×H×D)	mm	126.5 x 82 x 240 (Refer to outline drawing)										

- (*1) At Ta=25°C and maximum output power.
- (*2) For cases where conformance to various safety specs (UL, CSA,EN) are required, input voltage range will be 100 - 240VAC(50/60Hz).
- (*3) First in-rush current. Not applicable to the first 0.2ms in-rush current flowing into the power supply noise filter.
- (*4) Measure with JEITA RC-9131A probe, Bandwidth of scope :100MHz. (at 100uF electric capacitor and 0.47uF film capacitor on the test fixture board.)
- (*5) 85 - 265VAC , constant load.
- (*6) No load-Full load, constant input voltage.
- (*7) Constant current limit with automatic recovery. Over current condition for more than 5 seconds will cause the output to shutdown. Output current exceeding maximum rated output current for more than 10 seconds continuously will result to output shutdown.
- (*8) OVP circuit will shut down output, manual reset (Power cycle) or ON/OFF CNT signal reset.
- (*9) At 100/200VAC, nominal output voltage and maximum output current.
- (*10) Measured by the each measuring method of UL, CSA, EN and DENAN(at 60Hz), Ta=25°C.
- (*11) Ratings - Derating at standard mounting.
 - Load (%) is percent of maximum output power or maximum output current, whichever is greater.
 - As for other mountings, refer to derating curve.
 - For conditions of start up at -40°C to 10°C, refer to derating curve.
- (*12) As for DENAN,built to meet at 100VAC.
- (*13) Peak output current is less than 10 seconds, and duty 35% max.(200VAC Line only)
- (*14) Category 4 exposure levels : Truck transportation over U.S. highways, Composite two-wheeled trailer.
- (*15) It is compulsory to fix BRACKET onto product for MIL-STD-810F 516.5 Procedure I and MIL-STD-810F 514.5 category 10 compliance. Refer to mounting method.

● Recommended EMC Filter

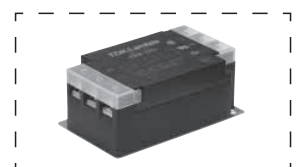

RSEN-2016
Please refer to "TDK-Lambda EMC Filters" catalog.

Please refer to page 50 for MIL-STD Mounting

Outline Drawing

[HWS1000/HD]

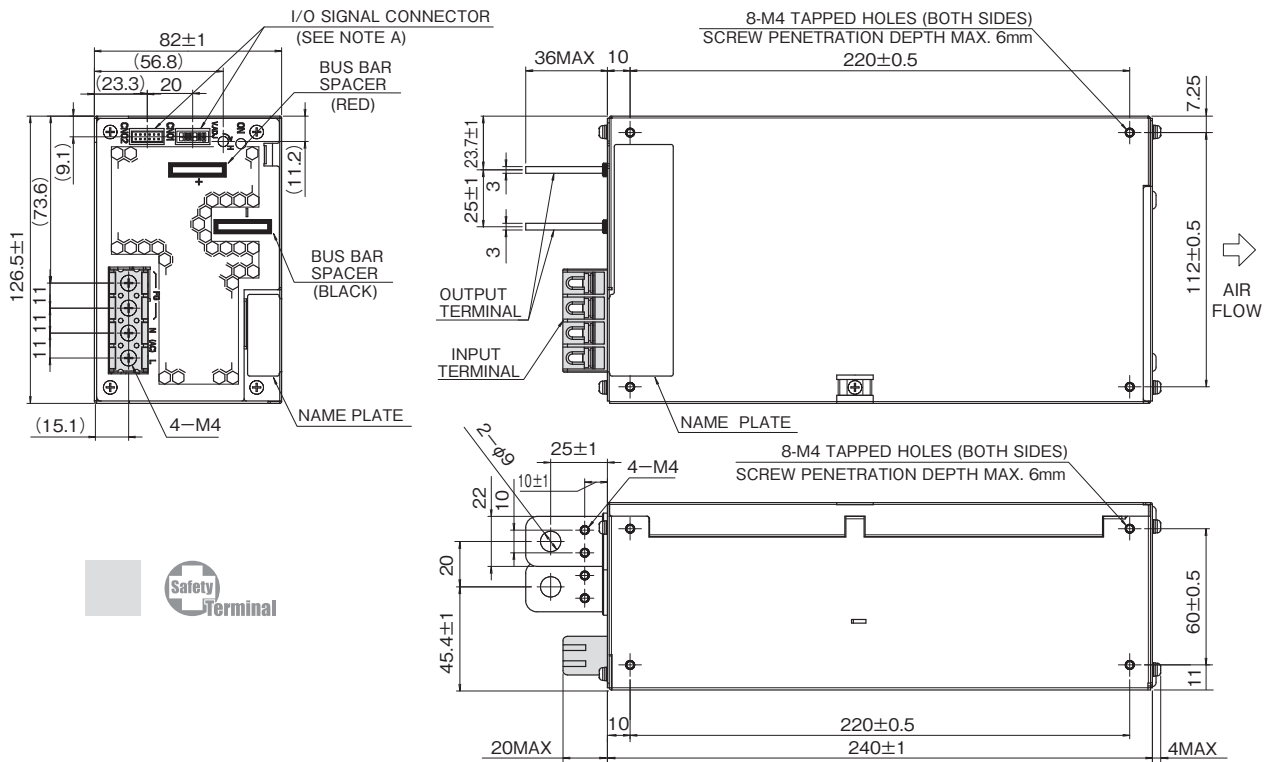

[unit: mm]
[Chassis material:SPCC-SD]

NOTES

- A: I/O SIGNAL CONNECTOR
- | | | |
|--------------------|----------------------------|----------|
| CONNECTOR | : S12B-PHSS(LF)(SN) | (JST) |
| MATCHING HOUSING | : PHDR-12VS | (JST) |
| MATCHING CONTACT | : SPHD-002T-P0.5(AWG28~24) | (JST) OR |
| | : SPHD-001T-P0.5(AWG26~22) | (JST) OR |
| | : BPHD-001T-P0.5(AWG26~22) | (JST) |
| HAND CRIMPING TOOL | : YRS-620(SPHD-002T-P0.5) | (JST) |
| | : YC-610R(SPHD-001T-P0.5) | (JST) |
| | : YC-610R(BPHD-001T-P0.5) | (JST) |

ACCESSORIES

- * ATTACHED CONNECTOR (3~7V)
SHORTING +S~+V, -S~-V, PV~REF & CNT~TOG
ATTACHED ON CN01 AT SHIPMENT
- * ATTACHED CONNECTOR (12_60V)
SHORTING +S~+V, -S~-V, PV~REF & CNT~TOG
ATTACHED ON CN01 AT SHIPMENT
- * A separate connector not included is required in order to utilize the power supply function.

Output Derating

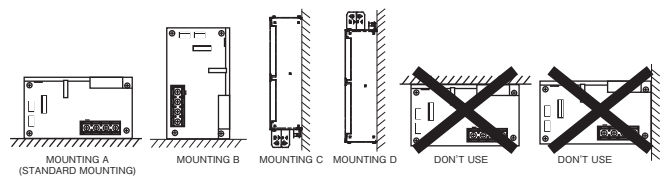
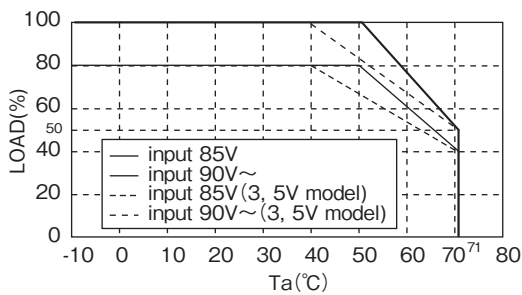

*It cannot be used even the product is flipped vertically.

Start-up condition at low temperature

●DERATING TO START UP AT Ta : -40 to -10°C

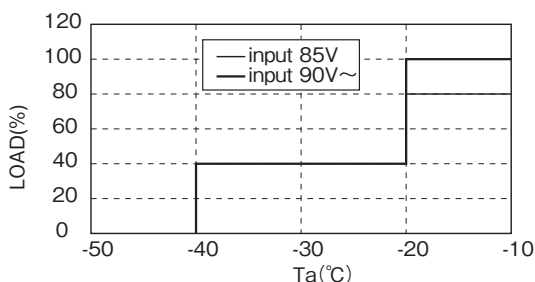

=NOTES=

- 1) Input voltage: Not gradual start up.
- 2) No Condensing.

HWS1500/HD Specifications (Read instruction manual carefully, before using the power supply unit.)

ITEMS/UNITS		MODEL	HWS1500 -3/HD	HWS1500 -5/HD	HWS1500 -6/HD	HWS1500 -7/HD	HWS1500 -12/HD	HWS1500 -15/HD	HWS1500 -24/HD	HWS1500 -36/HD	HWS1500 -48/HD	HWS1500 -60/HD								
Input	Voltage Range (*2)	V	AC85 - 265																	
	Frequency (*2)	Hz	47 - 63																	
	Power Factor (100/230VAC)(typ) (*1)		0.98 / 0.94																	
	Efficiency (100/200VAC)(typ) (*1)	%	72 / 75	77 / 81	79 / 82	81 / 83	82 / 85	83 / 87	84 / 88		86 / 90									
	Current (100/200VAC)(typ) (*1)	A	15.0 / 8.0		19.5 / 10.0		19.0 / 10.0													
	Inrush Current (100/200VAC)(typ) (*3)	A	20 / 40																	
	Leakage Current (100/240VAC) (*10)	mA	1.5 max																	
Output	Nominal Voltage	V	3.3	5	6	7.5	12	15	24	36	48	60								
	Maximum Current (100/200VAC)	A	300 / 300		250 / 250		200 / 200		125 / 125		100 / 100		65 / 70	42 / 46.5	32 / 32	25.6 / 28				
	Maximum Peak Current (*13)	A	—		300		240		—		105		70		—		42			
	Maximum Power (100VAC/200VAC)	W	990/990		1500/1500				1560/1680		1512/1674		1536/1536		1536/1680					
	Maximum Peak Power (*13)	W	—		1800				—		2520				—		2520			
	Maximum Line Regulation (*5)	mV	36				40				48		60		96		144		192	240
	Maximum Load Regulation (*6)	mV	60				72				90		144		150		288		360	
	Temperature Coefficient		Less than 0.02%/°C																	
	Ripple & Noise (*4)	+25 to +71°C	mVp-p	150				150				200		400						
			0°C	200				150				200		400						
			-10°C	220				200				240		400		600				
	Hold-up Time (typ) (*9)	ms	20				16				20									
	Voltage Adjustable Range	VDC	2.64 - 3.96	4.0 - 6.0	4.8 - 7.2	6.0 - 9.0	9.6 - 14.4	12.0 - 18.0	19.2 - 28.8	28.8 - 43.2	38.4 - 52.8	48.0 - 66.0								
Over Current Protection (*7)	A	> 315.0		> 262.5		> 210.0		> 131.2		> 105.0		> 68.2	> 44.1	> 33.6	> 26.8					
Over Voltage Protection (*8)	VDC	4.12 - 4.62	6.25 - 7.0	7.5 - 8.4	9.37 - 10.5	15.0 - 17.4	18.7 - 21.8	30.0 - 34.8	45.0 - 49.7	55.2 - 64.8	69.0 - 75.0									
Remote Sensing		Possible																		
Remote ON/OFF Control		Possible																		
Parallel Operation		Possible																		
Series Operation		Possible																		
Monitoring Signal		PF (Open collector output)																		
Line DIP		Designed to meet SEMI-F47 (200VAC Line only)																		
Other Function		PCB Coating on solder side and component side.																		
Environment	Operating Temperature (*11)	°C	-10 to +71, Guarantee start up at -40 to -10																	
		at Input Voltage 100VAC/200VAC	-10 to +40°C	W	990				1500				1560 / 1680	1512 / 1674	1536	1536 / 1680				
			+50°C	W	825	1250	1500				1560 / 1680	1512 / 1674	1536	1536 / 1680						
			+60°C	W	660	1000	1125				1170 / 1260	1134 / 1255	1152	1152 / 1260						
			+71°C	W	495	750				780 / 840	756 / 837	768	768 / 840							
	Storage Temperature	°C	-40 to +85																	
Operating Humidity	%RH	10 - 90 (No Condensing)																		
Storage Humidity	%RH	10 - 95 (No Condensing)																		
Vibration (*14)(*15)		At no operating, 10 - 55Hz (sweep for 1min.) 19.6m/s ² constant, X,Y,Z 1hour each. Designed to meet MIL-STD-810F 514.5 Category 4 figure 514.5C-1 and Category 10																		
Shock (In package) (*15)		Less than 196.1m/s ² Designed to meet MIL-STD-810F 516.5 Procedure I																		
Cooling		Forced air by blower fan																		
Isolation	Withstand Voltage		Input - FG : 2kVAC (20mA), Input - Output : 3kVAC (20mA), Output - CNT : 100VAC (100mA) Output - FG : 500VAC (300mA), (60V model 651VAC (390mA)) for 1min.																	
	Isolation Resistance		More than 100MΩ Output - FG : 500VDC More than 10MΩ Output - CNT : 100VDC at 25°C and 70%RH																	
Standards	Safety Standards (*12)		Approved by UL60950-1, CSA C22.2 No.,60950-1, EN60950-1, EN50178. Designed to meet DENAN.																	
	PFHC		Designed to meet IEC61000-3-2																	
	EMI		Designed to meet EN55011/EN55022-A, FCC-ClassA, VCCI-ClassA.																	
Mechanical	Immunity		Designed to meet IEC61000-4-2(Level 2,3), -3(Level 3), -4(Level 3), -5(Level 3,4), -6(Level 3), -8(Level 4), -11																	
	Weight (typ)	g	4000				3800													
Size (W x H x D)	mm	126.5 x 82 x 280 (Refer to outline drawing)																		

(*1) At Ta=25°C and maximum output power.

(*2) For cases where conformance to various safety specs (UL, CSA, EN) are required, input voltage range will be 100 - 240VAC (50/60Hz).

(*3) First in-rush current. Not applicable to the first 0.2ms in-rush current flowing into the power supply noise filter.

(*4) Measure with JEITA RC-9131A probe, bandwidth of scope :100MHz. (at 100uF electric capacitor and 0.47uF film capacitor on the test fixture board.)
Ripple noise spec for ambient temperature between -10 to 25 is a linearity value with respect to the -10 degrees C and 25 degrees C specs.

(*5) 85 - 265VAC , constant load.

(*6) No load-full load, constant input voltage.

(*7) Constant current limit with automatic recovery. Over current condition for more than 5 seconds will cause the output to shutdown. Output current exceeding maximum rated output current for more than 10 seconds continuously will result to output shutdown.

(*8) OVP circuit will shut down output, manual reset (power cycle) or ON/OFF CNT signal reset.

(*9) At 100/200VAC, nominal output voltage and maximum output current.

(*10) Measured by the each measuring method of UL, CSA, EN and DENAN (at 60Hz), Ta=25°C.

(*11) Ratings - Derating at standard mounting.

- Load (%) is percent of maximum output power or maximum output current, whichever is greater.

- As for other mountings, refer to derating curve.

- For conditions of start up at -40°C to -10°C, refer to derating curve.

(*12) As for DENAN, designed to meet at 100VAC.

(*13) Peak output current is less than 10 seconds, and duty 35% max.(200VAC Line only)

(*14) Category 4 exposure levels : Track transportation over U.S. highways.

(*15) It is compulsory to fix BRACKET onto product for MIL-STD-810F 516.5 Procedure I and MIL-STD-810F 514.5 category 10 compliance.
Refer to mounting method.

Recommended EMC Filter



RSEN-2030

Please refer to "TDK-Lambda EMC Filters" catalog.

Outline Drawing

[HWS1500/HD]

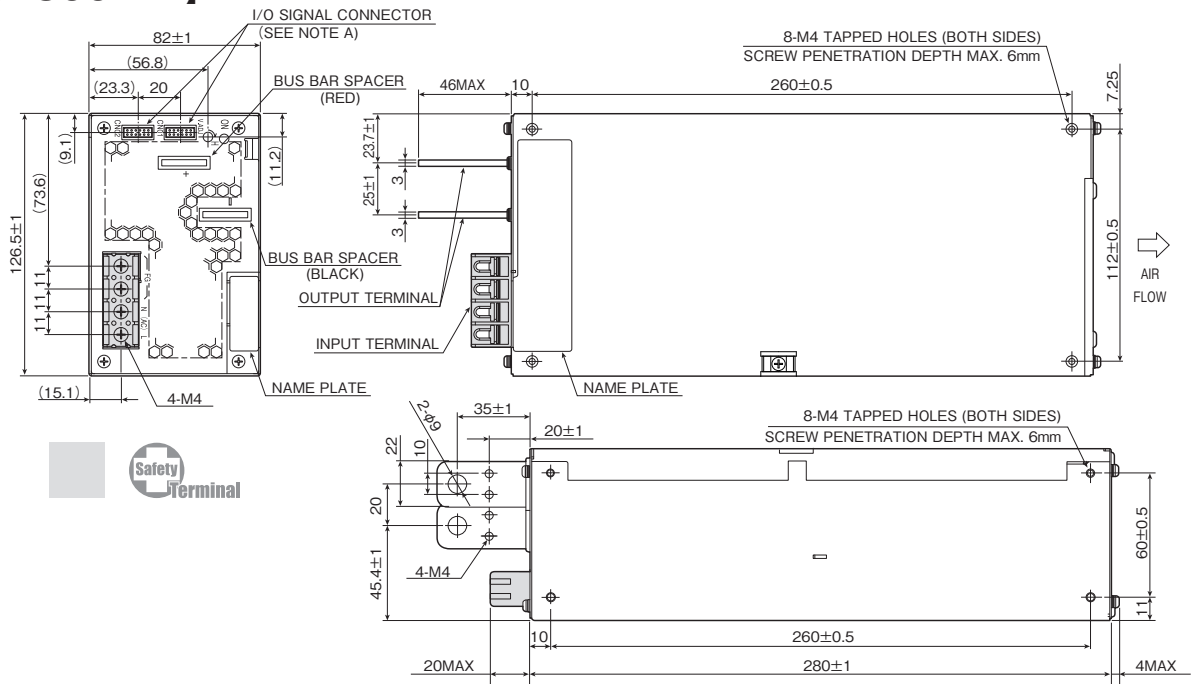

NOTES

- A: I/O SIGNAL CONNECTOR
 CONNECTOR : S12B-PHDSS(LF)(SN) (JST)
 MATCHING HOUSING : PHDR-12VS (JST)
 MATCHING CONTACT : SPHD-002T-P0.5(AWG28~24) (JST) OR
 SPHD-001T-P0.5(AWG26~22) (JST) OR
 BPHD-001T-P0.5(AWG26~22) (JST)
 HAND CRIMPING TOOL : YRS-620(SPHD-002T-P0.5) (JST)
 YC-610R(SPHD-001T-P0.5) (JST)
 YC-610(BPHD-001T-P0.5) (JST)

ACCESSORIES

- * ATTACHED CONNECTOR (3~7V)
 SHORTING +S~(+), -S~(-), PV~REF & CNT~TOG
 ATTACHED ON CN01 AT SHIPMENT
- * ATTACHED CONNECTOR (12~60V)
 SHORTING +S~+V, -S~V, PV~REF & CNT~TOG
 ATTACHED ON CN01 AT SHIPMENT
- * A separate connector not included is required in order to utilize the power supply function.

[unit: mm]
 [Chassis material:SPCC-SD]

Output Derating

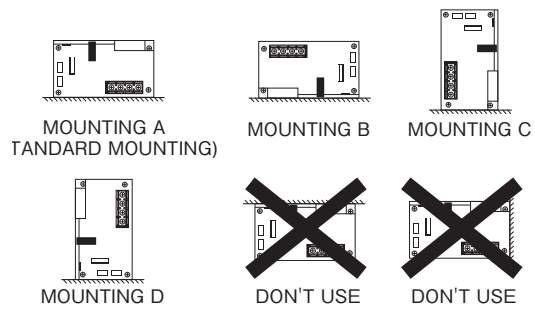
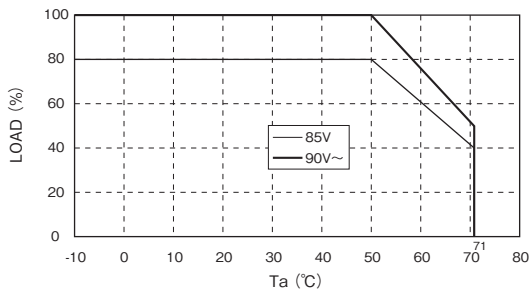

*It cannot be used even the product is flipped vertically.

Start-up condition at low temperature

●DERATING TO START UP AT Ta : -40 to -10°C

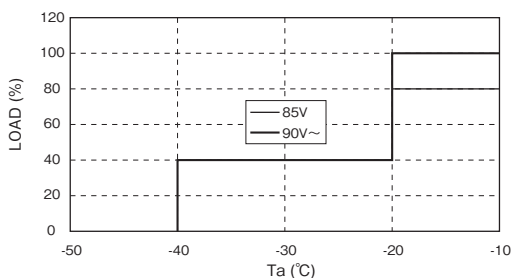

=NOTES=

- 1) Input voltage: Not gradual start up.
- 2) No condensing.
- 3) Output voltage becomes more stable by performing the following.
 - a) Electrolytic capacitor is added to an output.
 - +3.3V, +5V, +6V : LXZ 10V 5600uF (NIPPON CHEMI-CON) x 3 parallel
 - +7.5V : LXZ 16V 3900uF (NIPPON CHEMI-CON) x 3 parallel
 - +12V : LXZ 25V 2700uF (NIPPON CHEMI-CON) x3 parallel
 - +15V : LXZ 25V 2700uF (NIPPON CHEMI-CON) x3 parallel
 - +24V : LXZ 35V 1800uF (NIPPON CHEMI-CON) x3 parallel
 - +36V : LXZ 50V 1000uF (NIPPON CHEMI-CON) x3 parallel
 - +48V : LXZ 63V 820uF (NIPPON CHEMI-CON) x3 parallel
 - +60V : LXV 100V 270uF (NIPPON CHEMI-CON) x 3 parallel
 - b) Remote sensing function is used.
 Connect "+S" terminal to "+" terminal of the electrolytic capacitor and "-S" terminal to "-" terminal of the electrolytic capacitor with sensing wires.
- 4) Pay attention to above items before using the unit. Incorrect usage could lead to unstable output voltage.

HWS1800T/HD Specifications(Read instruction manual carefully, before using the power supply unit.)

ITEMS/UNITS	MODEL	HWS1800T													
		-3/HD	-5/HD	-6/HD	-7/HD	-12/HD	-15/HD	-24/HD	-36/HD	-48/HD	-60/HD				
Input	Voltage Range (*2)	3φ AC170 - 265													
	Frequency (*2)	47-63													
	Power Factor (200VAC)(typ) (*1)	0.94													
	Efficiency (200VAC)(typ) (*1)	75	81	82	84				88		90				
	Current (200VAC)(typ) (*1)	4.5			6.0				7.0						
	Inrush Current (200VAC)(typ) (*3)	40													
	Leakage Current(240VAC) (*10)	2.6 max													
Output	Nominal Voltage	3.3	5	6	7.5	12	15	24	36	48	60				
	Maximum Current	300		250	200	125	100	75	50	37.5	30				
	Maximum Peak Current (*12)	-		300	240	150	120	105	70	52.5	42				
	Maximum Power	990	1500				1800								
	Maximum Peak Power (*12)	-		1800				2520							
	Maximum Line Regulation (*5)	36			40	48	60	96	144	192	240				
	Maximum Load Regulation (*6)	60			72	90	144	216	288	360					
	Temperature Coefficient	Less than 0.02%/°C													
	Ripple & Noise (*4)	+25 to +71°C	150			200			250		300		400		
		0°C	200										250	300	400
		-10°C	220			250			300		400		600		
	Hold-up Time (typ) (*9)	20													
	Voltage Adjustable Range	2.64-3.96	4.0-6.0	4.8-7.2	6.0-9.0	9.6-14.4	12.0-18.0	19.2-28.8	28.8-43.2	38.4-52.8	48.0-66.0				
Over Current Protection (*7)	>315.0		>303.0	>242.4	>151.5	>121.2	>106.0	>70.7	>53.0	>42.4					
Over Voltage Protection (*8)	4.12-4.62	6.25-7.0	7.5-8.4	9.37-10.5	15.0-17.4	18.7-21.8	30.0-34.8	45.0-49.7	55.2-60.0	69.0-75.0					
Remote Sensing	Possible														
Remote ON/OFF Control	Possible														
Parallel Operation	Possible														
Series Operation	Possible														
Monitoring Signal	PF(Open collector output)														
Line DIP	Built to meet SEMI-F47														
Other Function	PCB Coating on solder side and component side.														
Environment	Operating Temperature (*11)	-10 to +71, Guarantee Start up -40 to -10													
	-10 to +40°C	W	990	1500				1800							
		W	825	1250	1500			1680							
		W	660	1000	1125			1300							
		W	495	750			900								
	Storage Temperature	-40 to +85													
	Operating Humidity	10 - 90 (No Condensing)													
Storage Humidity	10 - 95 (No Condensing)														
Vibration (*13)(*14)	At no operating, 10 - 55Hz (Sweep for 1min.) 19.6m/s ² Constant, X,Y,Z 1hour each. Designed to meet MIL-STD-810F 514.5 Category 4 figure 514.5C-1, Category 10														
Shock (In package) (*14)	Less than 196.1m/s ² Designed to meet MIL-STD-810F 516.5 Procedure I														
Cooling	Forced Air By Blower Fan														
Isolation	Withstand Voltage	Input - FG : 2kVAC (20mA), Input - Output : 3kVAC (20mA) Output-FG : 500VAC (300mA), (60V model 651VAC(390mA)), Output-CNT:100VAC (100mA) for 1min.													
	Isolation Resistance	More than 100MΩ Output - FG : 500VDC More than 10MΩ Output - CNT : 100VDC at 25°C and 70%RH													
Standards	Safety Standards	Approved by UL60950-1, CSA C22.2 No.60950-1, EN60950-1													
	EMI	Built to meet EN55011/EN55022-A, FCC-ClassA, VCCI-ClassA													
Mechanical	Immunity	Built to meet IEC61000-4-2(Level 2,3), -3(Level 3), -4(Level 3), -5(Level 3,4), -6(Level 3), -8(Level 4), -11													
	Weight (typ)	4000						3800							
Size (W×H×D)	mm 126.5 x 82 x 280 (Refer to Outline Drawing)														

- (*1) At Ta=25°C and maximum output power.
- (*2) For cases where conformance to various safety specs (UL, CSA, EN) are required, input voltage range will be 200 - 240VAC(50/60Hz).
- (*3) First in-rush current. Not applicable to the first 0.2ms in-rush current flowing into the power supply noise filter.
- (*4) Measure with JEITA RC-9131A probe, Bandwidth of scope :100MHz. (at 100uF electric capacitor and 0.47uF film capacitor on the test fixture board.)
Ripple noise spec for ambient temperature between -10 to 25 is a linearity value with respect to the -10 degrees C and 25 degrees C specs.
- (*5) 170 - 265VAC, constant load.
- (*6) No load-Full load, constant input voltage.
- (*7) Constant current limit with automatic recovery. Over current condition for more than 5 seconds will cause the output to shutdown. Output current exceeding maximum rated output current for more than 10 seconds continuously will result to output shutdown.
- (*8) OVP circuit will shut down output, manual reset (Power cycle) or ON/OFF CNT signal reset.
- (*9) At 200VAC(50/60Hz), nominal output voltage and maximum output current.
- (*10) Measured by the each measuring method of UL, CSA and EN (at 60Hz), Ta=25°C.
- (*11) Ratings - Derating at standard mounting.
- As for other mountings, refer to derating curve.
- For conditions of start up at -40°C~-10°C, refer to derating curve.
- (*12) Peak output current is less than 10 seconds, and duty 35% max.
- (*13) Category 4 exposure levels : Truck transportation over U.S. highways.
- (*14) It is compulsory to fix BRACKET onto product for MIL-STD-810F 516.5 Procedure I and MIL-STD-810F 514.5 category 10 compliance.

● Recommended EMC Filter



RSEN-2030
Please refer to "TDK-Lambda EMC Filters" catalog.

Please refer to page 50 for MIL-STD Mounting

Outline Drawing

[HWS1800T/HD]

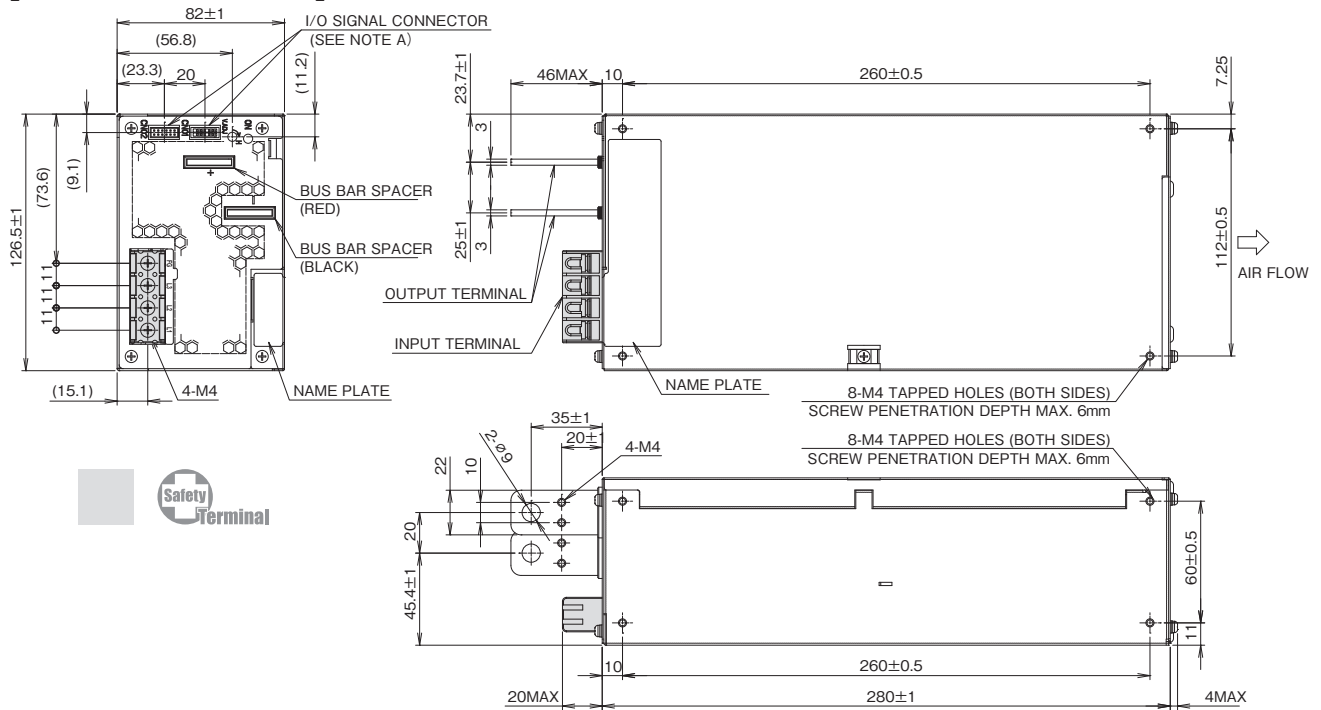

NOTES

- A: I/O SIGNAL CONNECTOR
 CONNECTOR : S12B-PHDSS(LF)(SN) (JST)
 MATCHING HOUSING : PHDR-12VS (JST)
 MATCHING CONTACT : SPHD-002T-P0.5(AWG28~24) (JST) OR
 SPHD-001T-P0.5(AWG26~22) (JST) OR
 BPHD-001T-P0.5(AWG26~22) (JST)
 HAND CRIMPING TOOL : YRS-620(SPHD-002T-P0.5) (JST)
 YC-610R(SPHD-001T-P0.5) (JST)
 YC-610R(BPHD-001T-P0.5) (JST)

ACCESSORIES

- * ATTACHED CONNECTOR (3~7V)
 SHORTING +S~(+), -S~(-), PV~REF & CNT~TOG
 ATTACHED ON CN01 AT SHIPMENT
- * ATTACHED CONNECTOR (12_60V)
 SHORTING +S~+V, -S~V, PV~REF & CNT~TOG
 ATTACHED ON CN01 AT SHIPMENT
- * A separate connector not included is required in order to utilize the power supply function.

[unit: mm]
 [Chassis material:SPCC-SD]

Output Derating

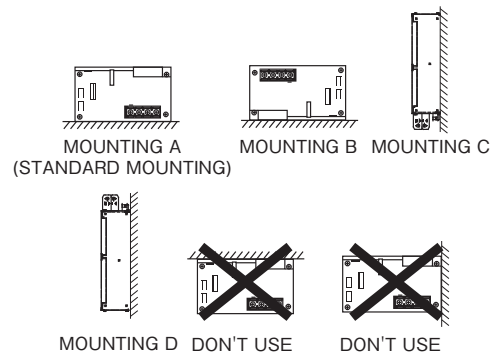
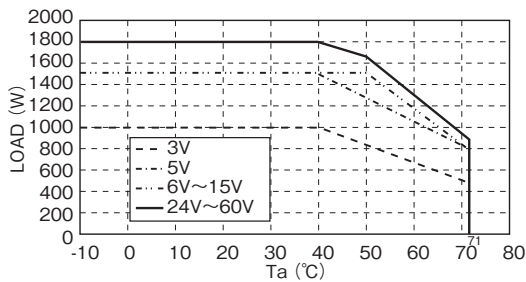

*It cannot be used even the product is flipped vertically.

Start-up condition at low temperature

●DERATING TO START UP AT Ta : -40 to -10°C

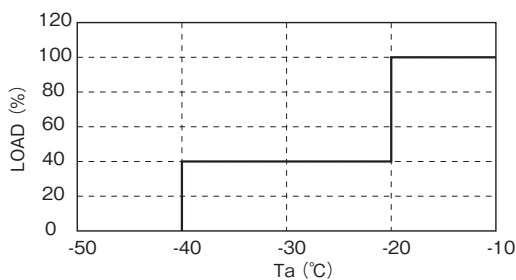

=NOTES=

- 1) Input voltage: Not gradual start up.
- 2) No Condensing.
- 3) Output voltage becomes more stable by performing the following.
 - a) Electrolytic capacitor is added to an output.
 - +3.3V,+5V,+6V : LXZ 10V 5600uF (NIPPON CHEMI-CON) x 3 parallel
 - +7.5V : LXZ 16V 3900uF (NIPPON CHEMI-CON) x 3 parallel
 - +12V : LXZ 25V 2700uF (NIPPON CHEMI-CON) x 3 parallel
 - +15V : LXZ 25V 2700uF (NIPPON CHEMI-CON) x 3 parallel
 - +24V : LXZ 35V 1800uF (NIPPON CHEMI-CON) x 3 parallel
 - +36V : LXZ 50V 1000uF (NIPPON CHEMI-CON) x 3 parallel
 - +48V : LXZ 63V 820uF (NIPPON CHEMI-CON) x 3 parallel
 - +60V : LXV 100V 270uF (NIPPON CHEMI-CON) x 3 parallel
 - b) Remote sensing function is used.
 Connect "+S" terminal to "+" terminal of the electrolytic capacitor and "-S" terminal to "-" terminal of the electrolytic capacitor with sensing wires.
- 4) Pay attention to above items before using the unit. Incorrect usage could lead to unstable output voltage.

POWER SUPPLY MOUNTING FOR MIL-STD

HWS

When MIL vibration(MIL-STD-810F 514.5 Category 4 figure 514.5C-1, Category 10) & MIL shock(MIL-STD-810F 516.5 Procedure I) specification is necessary, mount the power supply using the specification or equivalent. Please prepare the bracket of the specification reference.

Screw must not penetrate into power supply by more than 6mm.

HWS HD

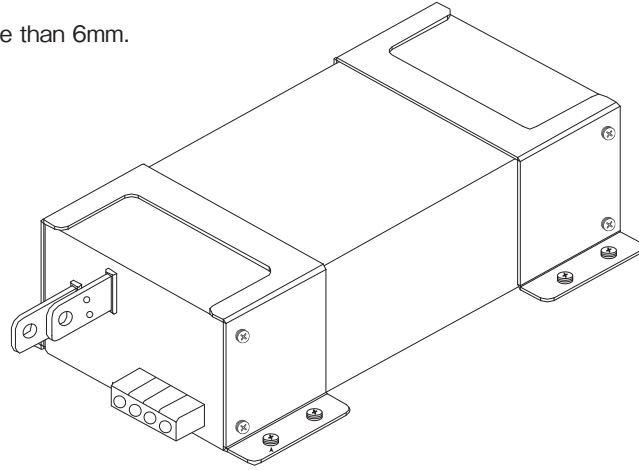

Specification Reference

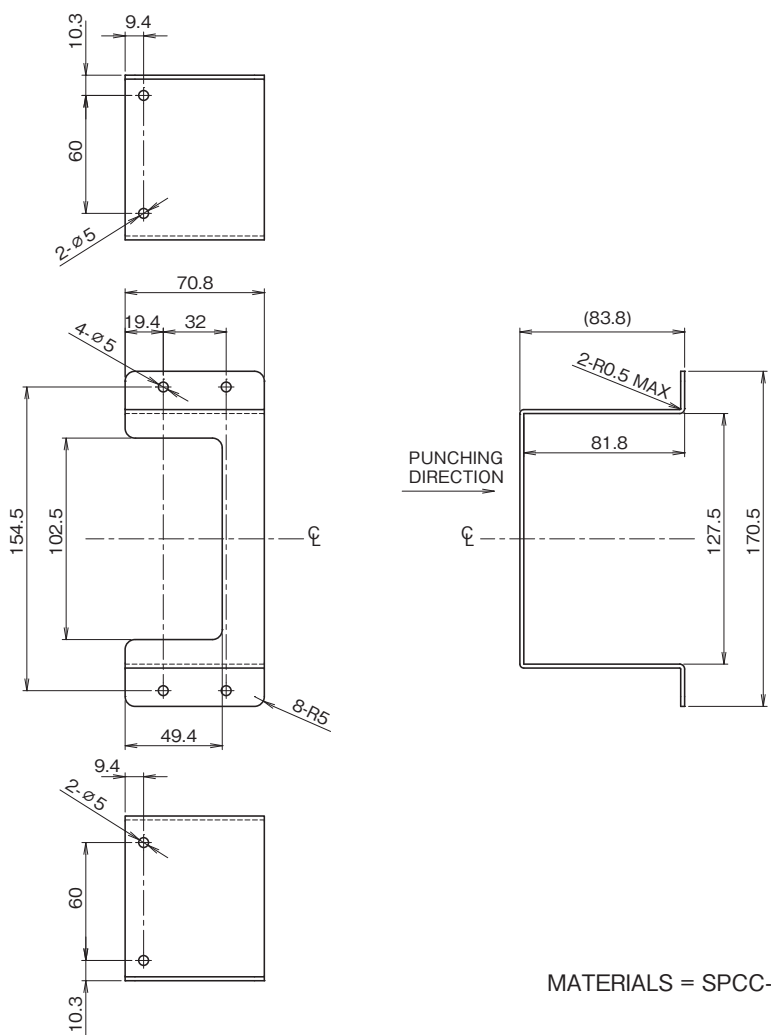
Model	Outline / Mounting method (mm)
HWS1000/HD HWS1500/HD HWS1800T/HD	 <p>MATERIALS = SPCC-SD (t=2.0)</p>

HWS ME

HWS-P

Instruction Manual

HWS/ME

Single Output 30W-1500W

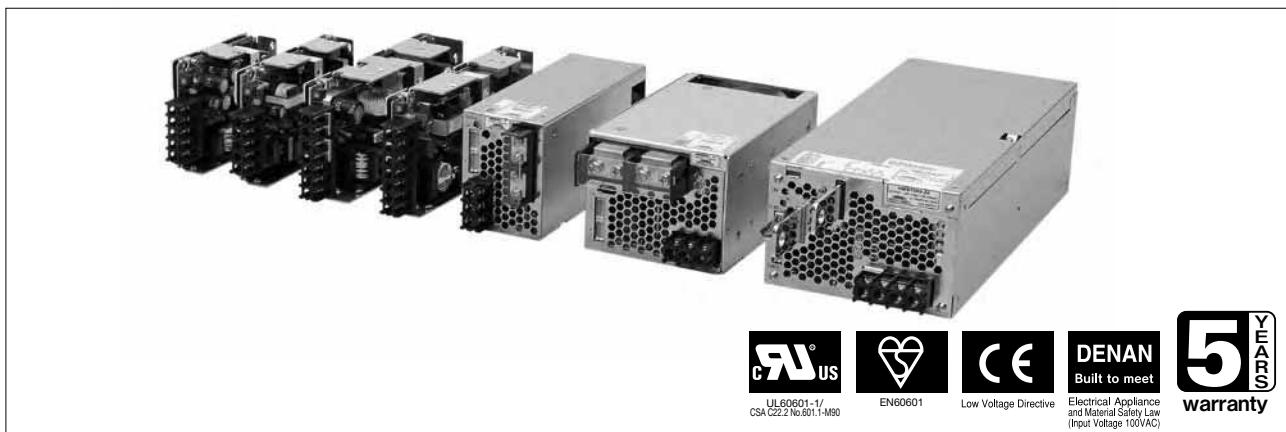

■ Features

- AC-DC switching power supply for medical equipment.
 - Approval UL60601-1 (see note)
 - Approval EN60601-1 (see note)
 - Approval CSA C22.2 No.601.1-M90 (see note)
- Environmentally-friendly: Conforming to RoHS directives. High-efficiency technology reduces power loss by heat generation. Fan stopping in power-off by external control reduces acoustic noise and saves energy.
- Easy to use: All models in the same height of 82mm. Mountable in 2U-height racks without dead space.
- Safety and reliability: “Safety terminal” covering current flowing part secures safety for users. “No screw-dropping” design prevents from losing screws during maintenance operation.
- HWS1500-48/ME realizes as high efficiency as 90%. Synchronous rectifier circuit improved efficiency of low voltage models by over 10% (HWS150-5/ME).

■ Model naming method

[HWS30-150]
HWS 50 – 5 / ME
Series name Output power

ME: Without cover, approved by safety standards for medical equipment

Nominal output voltage
 ex. 3: 3.3V, 5: 5V, 48: 48V

[HWS300-1500]
HWS 300 – 5 / ME
Series name Output power

ME: With cover and forced air cooling by built-in fan, approved safety standards for medical equipment

Nominal output voltage
 ex. 3: 3.3V, 5: 5V, 48: 48V

■ Applications



MED

■ Product Line up

Output Voltage	30W		50W		100W		150W	
	Output Current	Model	Output Current	Model	Output Current	Model	Output Current	Model
5V	6A	HWS30-5/ME	10A	HWS50-5/ME	20A	HWS100-5/ME	30A	HWS150-5/ME
12V	2.5A	HWS30-12/ME	4.3A	HWS50-12/ME	8.5A	HWS100-12/ME	13A	HWS150-12/ME
15V	2A	HWS30-15/ME	3.5A	HWS50-15/ME	7A	HWS100-15/ME	10A	HWS150-15/ME
24V	1.3A	HWS30-24/ME	2.2A	HWS50-24/ME	4.5A	HWS100-24/ME	6.5A	HWS150-24/ME
48V	0.65A	HWS30-48/ME	1.1A	HWS50-48/ME	2.1A	HWS100-48/ME	3.3A	HWS150-48/ME

Output Voltage	300W		600W		1000W		1500W	
	Output Current	Model	Output Current (Peak)	Model	Output Current (Peak)	Model	Output Current(*) (Peak)	Model
5V	—	—	120A	HWS600-5/ME	—	—	—	—
12V	27A	HWS300-12/ME	53A	HWS600-12/ME	—	—	—	—
15V	22A	HWS300-15/ME	43A	HWS600-15/ME	—	—	—	—
24V	14A (16.5A)	HWS300-24/ME	27A (31A)	HWS600-24/ME	46A (58.5A)	HWS1000-24/ME	65A/70A (105A)	HWS1500-24/ME
36V	—	—	—	—	30.7A/ (39A)	HWS1000-36/ME	42A/46.5A (70A)	HWS1500-36/ME
48V	7A	HWS300-48/ME	13A	HWS600-48/ME	23A/ (29.2A)	HWS1000-48/ME	32A/32A	HWS1500-48/ME

(Note) The following conditions are required.

● Please use the insulating material for the equipment chassis when the power supply is used in the equipment near patients.

● Approved with the basic insulation, an additional insulation circuit is required outside of the power supply.

(*) (100Vin/200Vin)

HWS30/ME Specifications (Read instruction manual carefully, before using the power supply unit.)

ITEMS/UNITS		MODEL	HWS30-5/ME	HWS30-12/ME	HWS30-15/ME	HWS30-24/ME	HWS30-48/ME
Input	Voltage Range	(*2) V	AC85 - 265 or DC120 - 370				
	Frequency	(*2) Hz	47 - 63				
	Efficiency (100/200VAC)(typ)	(*1) %	77 / 80	81 / 83		83 / 86	82 / 83
	Current (100/200VAC)(typ)	(*1) A	0.8 / 0.4				
	Inrush Current (100/200VAC)(typ)	(*3) A	14 / 28 at Ta=25°C, cold start				
	Leakage Current	(*10) mA	Less than 0.5. (0.2 (typ) at 100VAC / 0.4 (typ) at 230VAC)				
Output	Nominal Voltage	VDC	5	12	15	24	48
	Maximum Current	A	6	2.5	2	1.3	0.65
	Maximum Power	W	30				
	Maximum Line Regulation	(*5) mV	20	48	60	96	192
	Maximum Load Regulation	(*6) mV	40	96	120	192	384
	Temperature Coefficient		Less than 0.02% / °C				
	Maximum Ripple & Noise (0≤Ta≤70°C) (*4)	mVp-p	120	150		200	
	Maximum Ripple & Noise (-10≤Ta< 0°C) (*4)	mVp-p	160	180		240	
	Hold-up Time (typ)	(*9) ms	20				
	Voltage Adjustable Range	VDC	4.0 - 6.0	9.6 - 14.4	12.0 - 18.0	19.2 - 28.8	38.4 - 52.8
Function	Over Current Protection	(*7) A	>6.3	>2.62	>2.1	>1.36	>0.68
	Over Voltage Protection	(*8) VDC	6.25 - 7.25	15.0 - 17.4	18.8 - 21.8	30.0 - 34.8	55.2 - 64.8
	Remote Sensing		-				
	Parallel Operation		-				
	Series Operation		Possible				
	Line DIP		Designed to meet SEMI-F47 (200VAC Line only)				
Environment	Operating Temperature	(*11) °C	-10 to +70 (-10 to +50: 100%, +60: 60%, +70: 20%)				
	Storage Temperature	°C	-30 to +85				
	Operating Humidity	%RH	30 - 90 (No dewdrop)				
	Storage Humidity	%RH	10 - 95 (No dewdrop)				
	Vibration		At no operating, 10 - 55Hz (sweep for 1min) 19.6m/s² constant, X, Y, Z 1hour each.				
	Shock (In package)		Less than 196.1m/s²				
	Cooling		Convection cooling				
Isolation	Withstand Voltage		Input - FG : 2kVAC (20mA), Input - Output : 3kVAC (20mA) Output - FG : 500VAC (100mA) for 1min				
	Isolation Resistance		More than 100MΩ at 25°C and 70%RH Output - FG : 500VDC				
Standards	Safety Standards	(*12)	Approved by UL60601-1, EN60601-1, CSA-C22.2 No.601.1-M90				
	PFHC		Designed to meet IEC61000-3-2				
	Voltage Fluctuations / Flicker Emissions		Designed to meet IEC61000-3-3				
	EMI		Designed to meet EN55011/EN55022-B, FCC-B, VCCI-B				
Mechanical	Immunity		Designed to meet IEC61000-4-2(Level 3), -3(Level 3), -4(Level 3), -5(Level 3,4), -6(Level 3), -8(Level 4), -11				
	Weight (typ)	g	220				
	Size (W x H x D)	mm	26.5 x 82 x 95 (Refer to outline drawing)				

(*1) At 100/200VAC, Ta=25°C and maximum output power.

(*2) For cases where conformance to various safety specs (UL, EN, CSA) are required, to be described as 100 - 230VAC (50/60Hz).

(*3) Not applicable for the in-rush current to noise filter for less than 0.2ms.

(*4) Measure with JEITA RC-9131A probe, bandwidth of scope: 100MHz.
For start up at low ambient temperature and low input voltage, output ripple noise might not meet specification. However, there is no overshoot at start up and output ripple noise specification can be met after one second.

(*5) 85 - 265VAC, constant load.

(*6) No load-full load, constant input voltage.

(*7) Foldback current limit with automatic recovery. Not operate at over load or dead short condition for more than 30 seconds.

(*8) OVP circuit will shutdown output, manual reset (re power on).

(*9) At 100/200VAC, nominal output voltage and maximum output current.

(*10) Measured by the each measuring method of UL, EN and CSA (at 60Hz). When using it as a patient care equipment, all outer surfaces of the equipment shall be constructed of nonconductive material. See clause 19.5DV.2 of UL60601-1.

(*11) Ratings - Derating at standard mounting.
- Load (%) is percent of maximum output power or maximum output current, whichever is greater.
- As for other mountings, refer to derating curve.

(*12) As for UL60601-1, EN60601-1 and CSA-C22.2 No.601.1-M90, basic insulation.

● Recommended EMC Filter

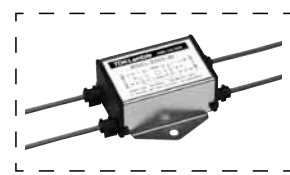

RSEL-2001 WL

Please refer to "TDK-Lambda EMC Filters" catalog.

Outline Drawing

[HWS30/ME]

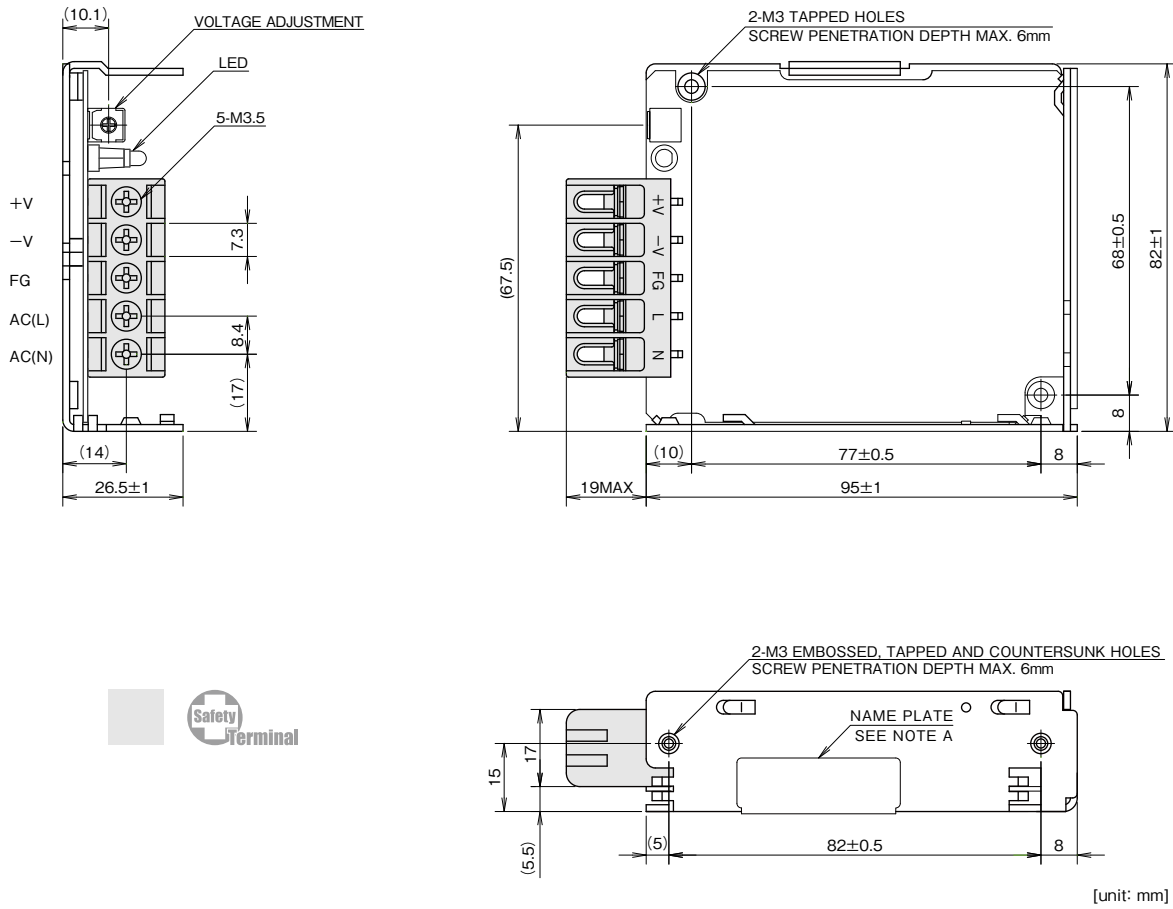

HWS

HWS HD

HWS ME

Output Derating

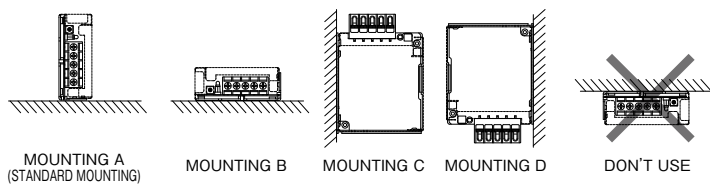
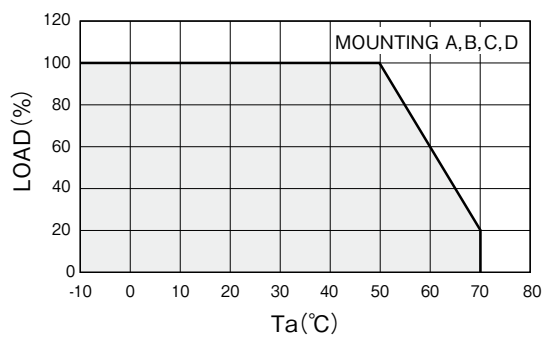

HWS-P

Instruction Manual

HWS50/ME Specifications(Read instruction manual carefully, before using the power supply unit.)

ITEMS/UNITS		MODEL	HWS50-5/ME	HWS50-12/ME	HWS50-15/ME	HWS50-24/ME	HWS50-48/ME
Input	Voltage Range (*2)	V	AC85 - 265 or DC120 - 370				
	Frequency (*2)	Hz	47 - 63				
	Power Factor (100/200VAC)(typ) (*1)		0.99 / 0.95				
	Efficiency (100/200VAC)(typ) (*1)	%	82 / 84	81 / 83		82 / 84	83 / 85
	Current (100/200VAC)(typ) (*1)	A	0.7 / 0.35				
	Inrush Current (100/200VAC)(typ) (*3)	A	14/28at, Ta=25°C, cold start				
	Leakage Current (*10)	mA	Less than 0.5. (0.2 (typ) at 100VAC / 0.4 (typ) at 230VAC)				
Output	Nominal Voltage	VDC	5	12	15	24	48
	Maximum Current	A	10	4.3	3.5	2.2	1.1
	Maximum Power	W	50	51.6	52.5	52.8	
	Maximum Line Regulation (*5)	mV	20	48	60	96	192
	Maximum Load Regulation (*6)	mV	40	96	120	192	384
	Temperature Coefficient		Less than 0.02% / °C				
	Maximum Ripple & Noise (0≤Ta≤70°C) (*4)	mVp-p	120	150		200	
	Maximum Ripple & Noise (-10≤Ta< 0°C) (*4)	mVp-p	160	180		240	
	Hold-up Time (typ) (*9)	ms	20				
	Voltage Adjustable Range	VDC	4.0 - 6.0	9.6 - 14.4	12.0 - 18.0	19.2 - 28.8	38.4 - 52.8
	Function	Over Current Protection (*7)	A	>10.5	>4.51	>3.67	>2.31
Over Voltage Protection (*8)		VDC	6.25 - 7.25	15.0 - 17.4	18.8 - 21.8	30.0 - 34.8	55.2 - 64.8
Remote Sensing			-				
Parallel Operation			-				
Series Operation			Possible				
Line DIP			Designed to meet SEMI-F47 (200VAC Line only)				
Environment		Operating Temperature (*11)	°C	-10 to +70 (-10 to +50: 100%, +60: 60%, +70: 20%)			
	Storage Temperature	°C	-30 to +85				
	Operating Humidity	%RH	30 - 90 (No dewdrop)				
	Storage Humidity	%RH	10 - 95 (No dewdrop)				
	Vibration		At no operating, 10 - 55Hz (sweep for 1min) 19.6m/s ² constant, X, Y, Z 1hour each.				
	Shock (In package)		Less than 196.1m/s ²				
	Cooling		Convection cooling				
Isolation	Withstand Voltage		Input - FG : 2kVAC (20mA), Input - Output : 3kVAC (20mA) Output - FG : 500VAC (100mA) for 1min				
	Isolation Resistance		More than 100MΩ at 25°C and 70%RH Output - FG : 500VDC				
Standards	Safety Standards (*12)		Approved by UL60601-1, EN60601-1, CSA-C22.2 No.601.1-M90				
	PFHC		Designed to meet IEC61000-3-2				
	Voltage Fluctuations / Flicker Emissions		Designed to meet IEC61000-3-3				
	EMI		Designed to meet EN55011/EN55022-B, FCC-B, VCCI-B				
Mechanical	Immunity		Designed to meet IEC61000-4-2(Level 3), -3(Level 3), -4(Level 3), -5(Level 3,4), -6(Level 3), -8(Level 4), -11				
	Weight (typ)	g	280				
	Size (W x H x D)	mm	26.5 x 82 x 120 (Refer to outline drawing)				

(*1) At 100/200VAC, Ta=25°C and maximum output power.

(*2) For cases where conformance to various safety specs (UL, EN, CSA) are required, to be described as 100 - 230VAC (50/60Hz).

(*3) Not applicable for the in-rush current to noise filter for less than 0.2ms.

(*4) Measure with JEITA RC-9131A probe, bandwidth of scope: 100MHz.

(*5) 85 - 265VAC, constant load.

(*6) No load-full load, constant input voltage.

(*7) Constant current limit and Hiccup with automatic recovery.
Not operate at over load or dead short condition for more than 30 seconds.

(*8) OVP circuit will shutdown output, manual reset (re power on).

(*9) At 100/200VAC, nominal output voltage and maximum output current.

(*10) Measured by the each measuring method of UL, EN and CSA (at 60Hz).
When using it as a patient care equipment, all outer surfaces of the equipment shall be constructed of nonconductive material. See clause 19.5DV.2 of UL60601-1.

(*11) Ratings - Derating at standard mounting.
- Load (%) is percent of maximum output power or maximum output current, whichever is greater.
- As for other mountings, refer to derating curve.

(*12) As for UL60601-1, EN60601-1 and CSA-C22.2 No.601.1-M90, basic insulation.

● Recommended EMC Filter

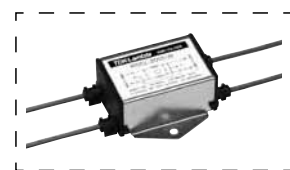

RSEL-2001 WL
Please refer to "TDK-Lambda EMC Filters" catalog.

Outline Drawing

[HWS50/ME]

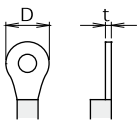
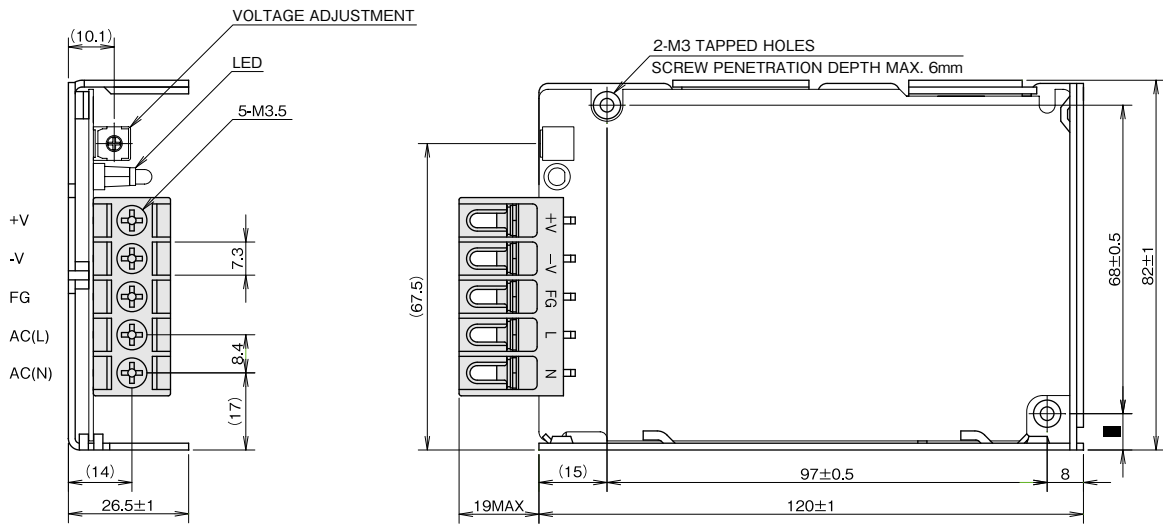

Recommended Solderless Terminal		
D (max)	t (max)	Qty (max)
6.8mm	0.8mm	2 pcs

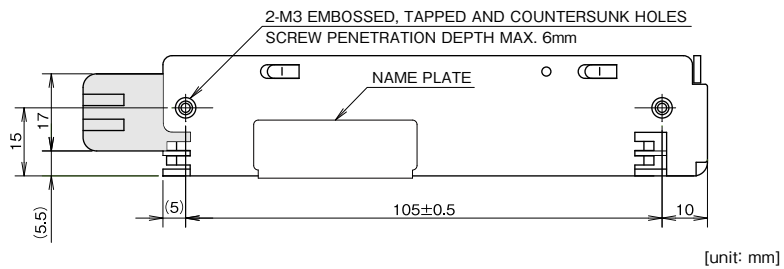

[unit: mm]

Output Derating

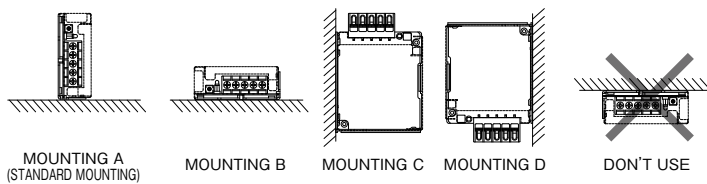
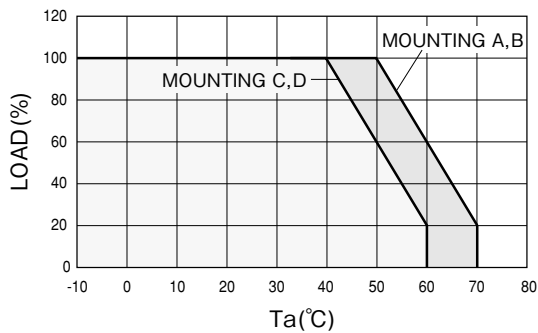

HWS100/ME Specifications (Read instruction manual carefully, before using the power supply unit.)

ITEMS/UNITS		MODEL	HWS100-5/ME	HWS100-12/ME	HWS100-15/ME	HWS100-24/ME	HWS100-48/ME
Input	Voltage Range (*2)	V	AC85 - 265 or DC120 - 370				
	Frequency (*2)	Hz	47 - 63				
	Power Factor (100/200VAC)(typ) (*1)		0.99 / 0.95				
	Efficiency (100/200VAC)(typ) (*1)	%	83 / 86		84 / 87		
	Current (100/200VAC)(typ) (*1)	A	1.3 / 0.65				
	Inrush Current (100/200VAC)(typ) (*3)	A	14/28 at, Ta=25°C, cold start				
	Leakage Current (*10)	mA	Less than 0.5. (0.2 (typ) at 100VAC / 0.4 (typ) at 230VAC)				
Output	Nominal Voltage	VDC	5	12	15	24	48
	Maximum Current	A	20	8.5	7	4.5	2.1
	Maximum Power	W	100	102	105	108	100.8
	Maximum Line Regulation (*5)	mV	20	48	60	96	192
	Maximum Load Regulation (*6)	mV	40	96	120	192	384
	Temperature Coefficient		Less than 0.02% / °C				
	Maximum Ripple & Noise (0≤Ta≤70°C) (*4)	mVp-p	120	150			200
	Maximum Ripple & Noise (-10≤Ta< 0°C) (*4)	mVp-p	160	180			240
	Hold-up Time (typ) (*9)	ms	20				
	Voltage Adjustable Range	VDC	4.0 - 6.0	9.6 - 14.4	12.0 - 18.0	19.2 - 28.8	38.4 - 52.8
Function	Over Current Protection (*7)	A	>21.0	>8.92	>7.35	>4.72	>2.20
	Over Voltage Protection (*8)	VDC	6.25 - 7.25	15.0 - 17.4	18.8 - 21.8	30.0 - 34.8	55.2 - 64.8
	Remote Sensing		Possible				
	Parallel Operation		-				
	Series Operation		Possible				
	Line DIP		Designed to meet SEMI-F47 (200VAC Line only)				
	Operating Temperature (*11)	°C	-10 to +70 (-10 to +50: 100%, +60: 60%, +70: 20%)				
Environment	Storage Temperature	°C	-30 to +85				
	Operating Humidity	%RH	30 - 90 (No dewdrop)				
	Storage Humidity	%RH	10 - 95 (No dewdrop)				
	Vibration		At no operating, 10 - 55Hz (sweep for 1min) 19.6m/s ² constant, X, Y, Z 1hour each.				
	Shock (In package)		Less than 196.1m/s ²				
	Cooling		Convection cooling				
	Isolation	Withstand Voltage		Input - FG : 2kVAC (20mA), Input - Output : 3kVAC (20mA) Output - FG : 500VAC (100mA) for 1min			
Isolation Resistance			More than 100MΩ at 25°C and 70%RH Output - FG : 500VDC				
Standards	Safety Standards (*12)		Approved by UL60601-1, EN60601-1, CSA-C22.2 No.601.1-M90				
	PFHC		Designed to meet IEC61000-3-2				
	Voltage Fluctuations / Flicker Emissions		Designed to meet IEC61000-3-3				
	EMI		Designed to meet EN55011/EN55022-B, FCC-B, VCCI-B				
Mechanical	Immunity		Designed to meet IEC61000-4-2(Level 3), -3(Level 3), -4(Level 3), -5(Level 3,4), -6(Level 3), -8(Level 4), -11				
	Weight (typ)	g	450				
	Size (W x H x D)	mm	28 x 82 x 160 (Refer to outline drawing)				

(*1) At 100/200VAC, Ta=25°C and maximum output power.

(*2) For cases where conformance to various safety specs (UL, EN, CSA) are required, to be described as 100 - 230VAC (50/60Hz).

(*3) Not applicable for the in-rush current to noise filter for less than 0.2ms.

(*4) Measure with JEITA RC-9131A probe, bandwidth of scope: 100MHz.

(*5) 85 - 265VAC, constant load.

(*6) No load-full load, constant input voltage.

(*7) Constant current limit and Hiccup with automatic recovery.
Not operate at over load or dead short condition for more than 30 seconds.

(*8) OVP circuit will shutdown output, manual reset (re power on).

(*9) At 100/200VAC, nominal output voltage and maximum output current.

(*10) Measured by the each measuring method of UL, EN and CSA (at 60Hz).
When using it as a patient care equipment, all outer surfaces of the equipment shall be constructed of nonconductive material. See clause 19.5DV.2 of UL60601-1.

(*11) Ratings - Derating at standard mounting.
- Load (%) is percent of maximum output power or maximum output current, whichever is greater.
- As for other mountings, refer to derating curve.

(*12) As for UL60601-1, EN60601-1 and CSA-C22.2 No.601.1-M90, basic insulation.

● Recommended EMC Filter

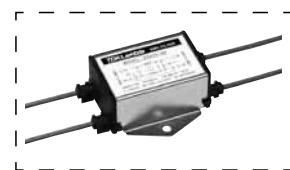

RSEL-2002WL

Please refer to "TDK-Lambda EMC Filters" catalog.

Outline Drawing

[HWS100/ME]

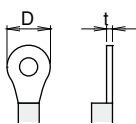
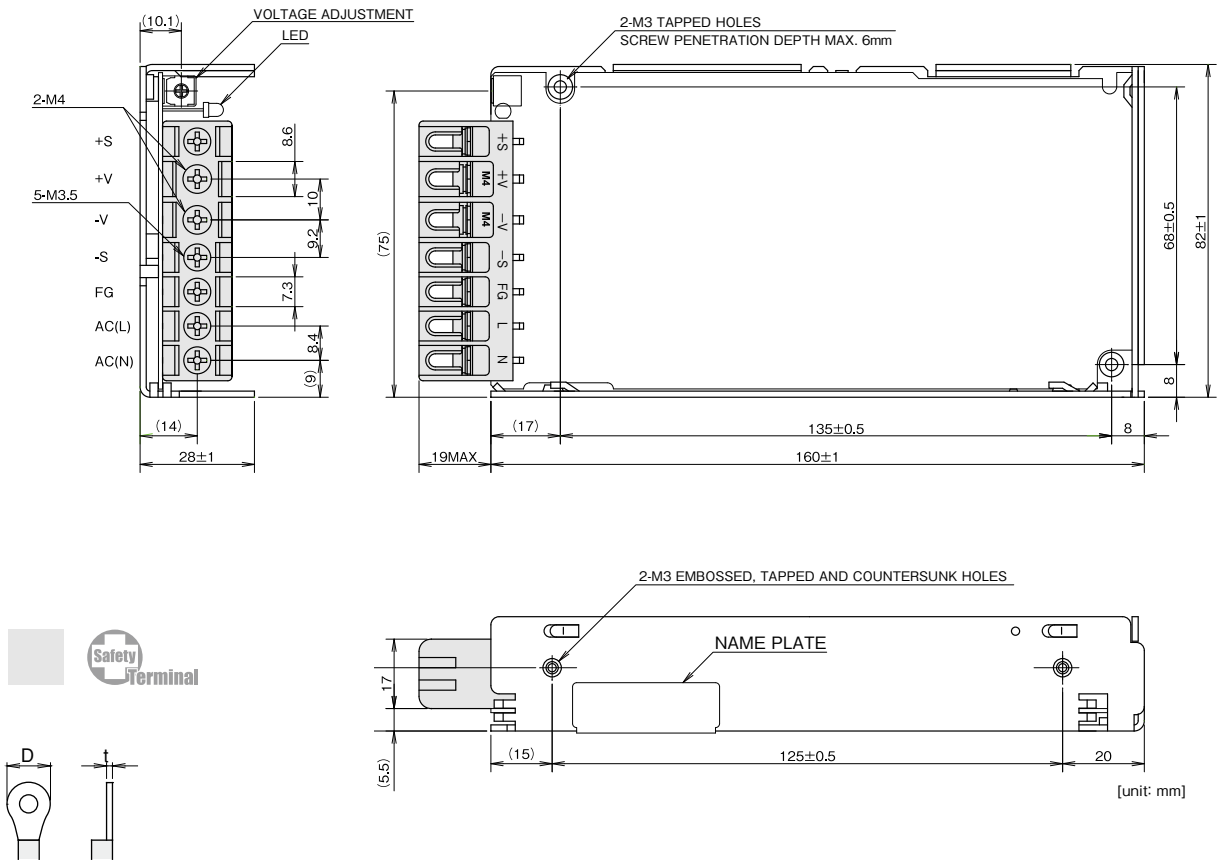

Terminal	Recommended Solderless Terminal		
	D (max)	t (max)	Qty (max)
+V / -V	8.1mm	0.8mm	2 pcs
		1.0mm	1 pc
Others	6.8mm	0.8mm	2 pcs

ACCESSORIES
 * SHORT PIECE (NET 2) FOR SHORTING PURPOSE (+S to +V, -S to -V) : MOUNTED AT TIME OF SHIPMENT.

Output Derating

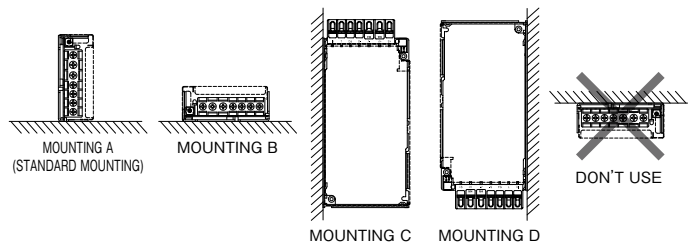
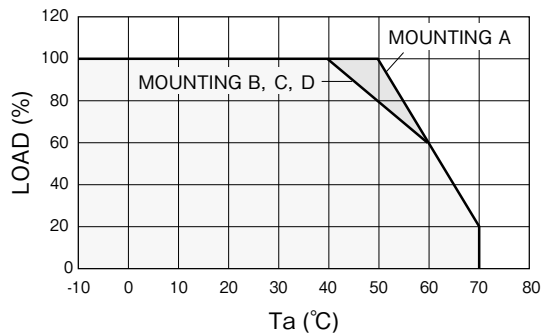

HWS150/ME Specifications (Read instruction manual carefully, before using the power supply unit.)

ITEMS/UNITS		MODEL	HWS150-5/ME	HWS150-12/ME	HWS150-15/ME	HWS150-24/ME	HWS150-48/ME
Input	Voltage Range	(*2) V	AC85 - 265 or DC120 - 370				
	Frequency	(*2) Hz	47 - 63				
	Power Factor (100/200VAC)(typ)	(*1)	0.99 / 0.95				
	Efficiency (100/200VAC)(typ)	(*1) %	83 / 86		85 / 88		
	Current (100/200VAC)(typ)	(*1) A	1.9 / 0.95				
	Inrush Current (100/200VAC)(typ)	(*3) A	14 / 28 at Ta=25°C, cold start				
	Leakage Current	(*10) mA	Less than 0.5. (0.2 (typ) at 100VAC / 0.4 (typ) at 230VAC)				
Output	Nominal Voltage	VDC	5	12	15	24	48
	Maximum Current	A	30	13	10	6.5	3.3
	Maximum Power	W	150	156	150	156	158.4
	Maximum Line Regulation	(*5) mV	20	48	60	96	192
	Maximum Load Regulation	(*6) mV	40	96	120	192	384
	Temperature Coefficient (%)		Less than 0.02% / °C				
	Maximum Ripple & Noise (0≤Ta≤70°C)(*4)	mVp-p	120	150			200
	Maximum Ripple & Noise (-10≤Ta<0°C)(*4)	mVp-p	160	180			240
	Hold-up Time (typ)	(*9) ms	20				
	Voltage Adjustable Range	VDC	4.0 - 6.0	9.6 - 14.4	12.0 - 18.0	19.2 - 28.8	38.4 - 52.8
Function	Over Current Protection	(*7) A	>31.5	>13.6	>10.5	>6.82	>3.46
	Over Voltage Protection	(*8) VDC	6.25 - 7.25	15.0 - 17.4	18.8 - 21.8	30.0 - 34.8	55.2 - 64.8
	Remote Sensing		Possible				
	Parallel Operation		-				
	Series Operation		Possible				
	Line DIP		Designed to meet SEMI-F47 (200VAC Line only)				
Environment	Operating Temperature	(*11) °C	-10 to +70 (-10 to +50: 100%, +60: 60%, +70: 20%)				
	Storage Temperature	°C	-30 to +85				
	Operating Humidity	%RH	30 - 90 (No dewdrop)				
	Storage Humidity	%RH	10 - 95 (No dewdrop)				
	Vibration		At no operating, 10 - 55Hz (sweep for 1min) 19.6m/s ² constant, X, Y, Z 1hour each.				
	Shock (In package)		Less than 196.1m/s ²				
	Cooling		Convection cooling				
Isolation	Withstand Voltage		Input - FG : 2kVAC (20mA), Input - Output : 3kVAC (20mA) Output - FG : 500VAC (100mA) for 1min				
	Isolation Resistance		More than 100MΩ at 25°C and 70%RH Output - FG : 500VDC				
Standards	Safety Standards	(*12)	Approved by UL60601-1, EN60601-1, CSA-C22.2 No.601.1-M90				
	PFHC		Designed to meet IEC61000-3-2				
	Voltage Fluctuations / Flicker Emissions		Designed to meet IEC61000-3-3				
	EMI		Designed to meet EN55011/EN55022-B, FCC-B, VCCI-B				
Mechanical	Immunity		Designed to meet IEC61000-4-2(Level 3), -3(Level 3), -4(Level 3), -5(Level 3,4), -6(Level 3), -8(Level 4), -11				
	Weight (typ)	g	500				
	Size (W x H x D)	mm	37 x 82 x 160 (Refer to outline drawing)				

(*1) At 100/200VAC, Ta=25°C and maximum output power.

(*2) For cases where conformance to various safety specs (UL, EN, CSA) are required, to be described as 100 - 230VAC (50/60Hz).

(*3) Not applicable for the in-rush current to noise filter for less than 0.2ms.

(*4) Measure with JEITA RC-9131A probe, bandwidth of scope: 100MHz.

(*5) 85 - 265VAC, constant load.

(*6) No load-full load, constant input voltage.

(*7) Constant current limit and Hiccup with automatic recovery.
Not operate at over load or dead short condition for more than 30 seconds.

(*8) OVP circuit will shutdown output, manual reset (re power on).

(*9) At 100/200VAC, nominal output voltage and maximum output current.

(*10) Measured by the each measuring method of UL, EN and CSA (at 60Hz).
When using it as a patient care equipment, all outer surfaces of the equipment shall be constructed of nonconductive material. See clause 19.5DV.2 of UL60601-1.

(*11) Ratings - Derating at standard mounting.
- Load (%) is percent of maximum output power or maximum output current, whichever is greater.
- As for other mountings, refer to derating curve.

(*12) As for UL60601-1, EN60601-1 and CSA-C22.2 No.601.1-M90, basic insulation.

● Recommended EMC Filter

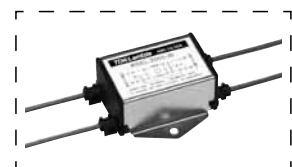

RSEL-2003WL

Please refer to "TDK-Lambda EMC Filters" catalog.

Outline Drawing

[HWS150/ME]

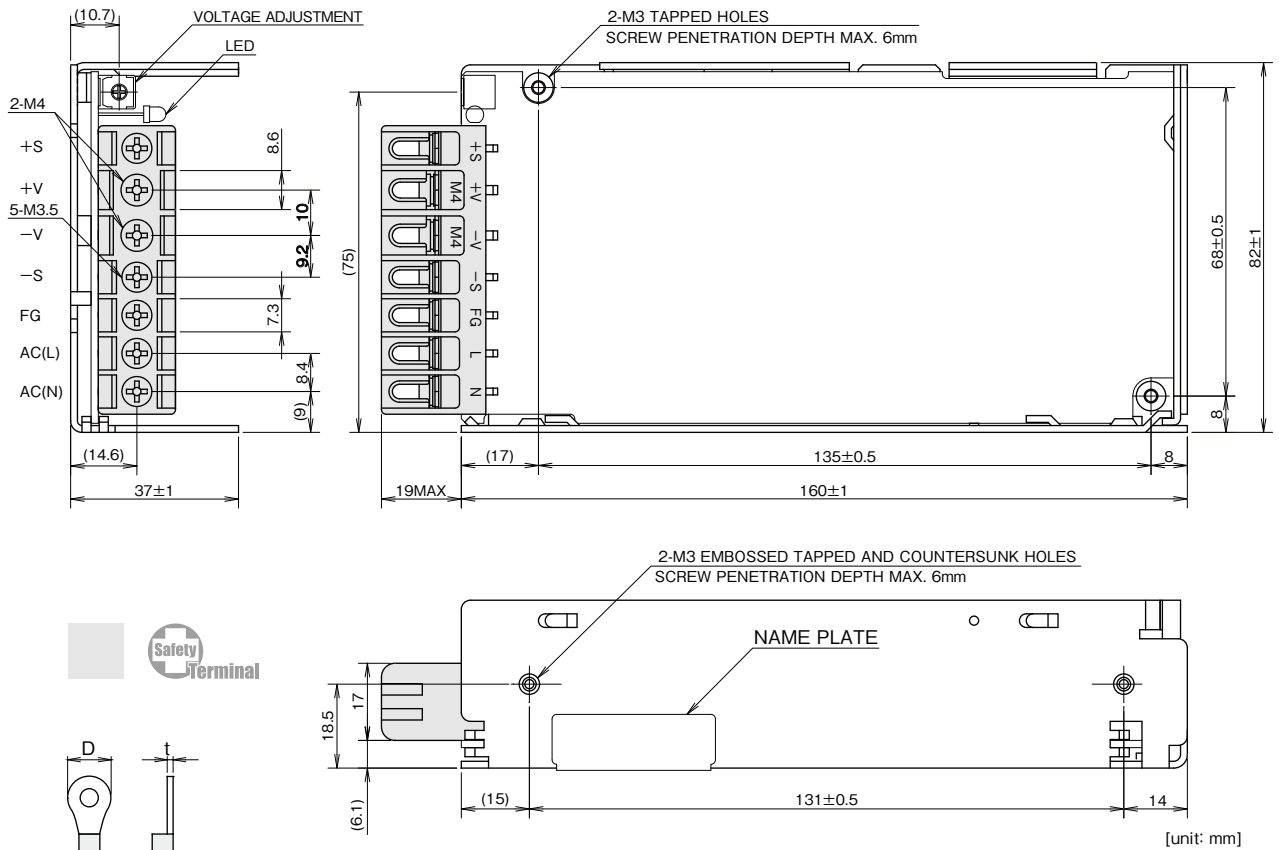

Terminal	Recommended Solderless Terminal		
	D (max)	t(max)	Qty (max)
+V / -V	8.1mm	0.8mm	2 pcs
		1.0mm	1 pc
Others	6.8mm	0.8mm	2 pcs

ACCESSORIES
 * SHORT PIECE (NET 2) FOR SHORTING PURPOSE (+S to +V, -S to -V) : MOUNTED AT TIME OF SHIPMENT.

Output Derating

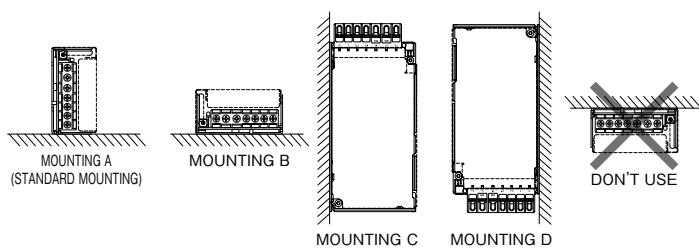
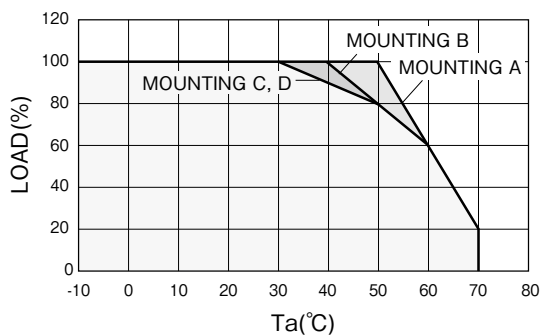

HWS300/ME Specifications(Read instruction manual carefully, before using the power supply unit.)

ITEMS/UNITS		MODEL	HWS300-12/ME	HWS300-15/ME	HWS300-24/ME	HWS300-48/ME
Input	Voltage Range (*3)	V	AC85 - 265 or DC120 - 330			
	Frequency (*3)	Hz	47 - 63			
	Power Factor (100/200VAC)(typ) (*2)		0.99 / 0.95			
	Efficiency (100/200VAC)(typ) (*2)	%	80 / 83		82 / 85	
	Current (100/200VAC)(typ) (*2)	A	4.1 / 2.1			
	Inrush Current (100/200VAC)(typ) (*4)	A	20 / 40			
	Leakage Current (*11)	mA	Less than 0.5. (0.15 (typ) at 100VAC / 0.39 (typ) at 230VAC)			
Output	Nominal Voltage	VDC	12	15	24	48
	Maximum Current (*1)	A	27	22	14 (16.5)	7
	Maximum Power	W	324	330	336	
	Maximum Line Regulation (*6)	mV	48	60	96	192
	Maximum Load Regulation (*7)	mV	72	90	144	288
	Temperature Coefficient		Less than 0.02% / °C			
	Maximum Ripple & Noise (0≤Ta≤70°C) (*5)	mVp-p	150		350	
	Maximum Ripple & Noise (-10≤Ta≤0°C) (*5)	mVp-p	200		400	
	Hold-up Time (typ) (*10)	ms	20			
	Voltage Adjustable Range	VDC	9.6 - 14.4	12.0 - 18.0	19.2 - 28.8	38.4 - 52.8
	Function	Over Current Protection (*8)	A	>28.4	>23.1	>16.7
Over Voltage Protection (*9)		VDC	15.0 - 17.4	18.8 - 21.8	30.0 - 34.8	55.2 - 64.8
Remote Sensing			Possible			
Remote ON/OFF Control			Possible			
Parallel Operation			Possible			
Series Operation			Possible			
Monitoring Signal			PF (Open collector output)			
Line DIP			Designed to meet SEMI-F47 (200VAC Line only)			
Operating Temperature (*12)		°C	-10 to +70 (-10 to +50: 100%, +70: 50%)			
Storage Temperature		°C	-30 to +85			
Environment	Operating Humidity	%RH	10 to 90 (No dewdrop)			
	Storage Humidity	%RH	10 to 95 (No dewdrop)			
	Vibration		At no operating, 10 - 55Hz (sweep for 1min) 19.6m/s ² constant, X, Y, Z 1hour each.			
	Shock (In package)		Less than 196.1m/s ²			
	Cooling		Forced air by blower fan			
	Isolation	Withstand Voltage		Input - FG : 2.5kVAC (20mA), Input - Output : 3kVAC (20mA) Output - FG: 500VAC (100mA), Output-CNT: 100VAC(100mA) for 1min		
Isolation Resistance			More than 100MΩ Output - FG : 500VDC More than 10MΩ Output -CNT : 100VDC at 25°C and 70%RH			
Standards	Safety Standards (*13)		Approved by UL60601-1, EN60601-1, CSA-C22.2 No601.1-M90			
	PFHC		Designed to meet IEC61000-3-2			
	Voltage Fluctuations / Flicker Emissions		Designed to meet IEC61000-3-3			
	EMI		Designed to meet EN55011/EN55022-B, FCC-B, VCCI-B			
	Immunity		Designed to meet IEC61000-4-2(Level 3), -3(Level 3), -4(Level 3), -5(Level 3,4), -6(Level 3), -8(Level 4), -11			
Mechanical	Weight (typ)	g	1000			
	Size (W x H x D)	mm	61 x 82 x 165 (Refer to outline drawing)			

(*1) ():Peak output current at 200VAC. Operating time at peak output is less than 10 sec, duty is less than 35%.

(*2) At 100/200VAC, Ta=25°C and maximum output power.

(*3) For cases where conformance to various safety specs (UL, EN, CSA) are required, to be described as 100 - 240VAC (50/60Hz).

(*4) Not applicable for the inrush current to noise filter for less than 0.2ms.

(*5) Measure with JEITA RC-9131A probe, bandwidth of scope: 100MHz.

(*6) 85 - 265VAC, constant load.

(*7) No load-full load, constant input voltage.

(*8) Constant current limit with automatic recovery.

Avoid to operate at over load or short circuit condition for more than 30 seconds.

(*9) OVP circuit will shut the output down, manual reset (CNT reset or re power on).

(*10) At 100/200VAC, nominal output voltage and maximum output current.

(*11) Measured by the each measuring method of UL, EN, and CSA (at 60Hz), Ta=25°C.

When using it as a patient care equipment, all outer surfaces of the equipment shall be constructed of nonconductive material. See clause 19.5DV.2 of UL60601-1.

(*12) Ratings - Derating at standard mounting. Refer to output derating curve.

- Load (%) is percent of maximum output power or maximum output current, whichever is greater.

(*13) As for UL60601-1, EN60601-1 and CSA-C22.2No601.1-M90, basic insulation.

● Recommended EMC Filter



RSEN-2006L

Please refer to "TDK-Lambda EMC Filters" catalog.

Outline Drawing

[HWS300/ME]

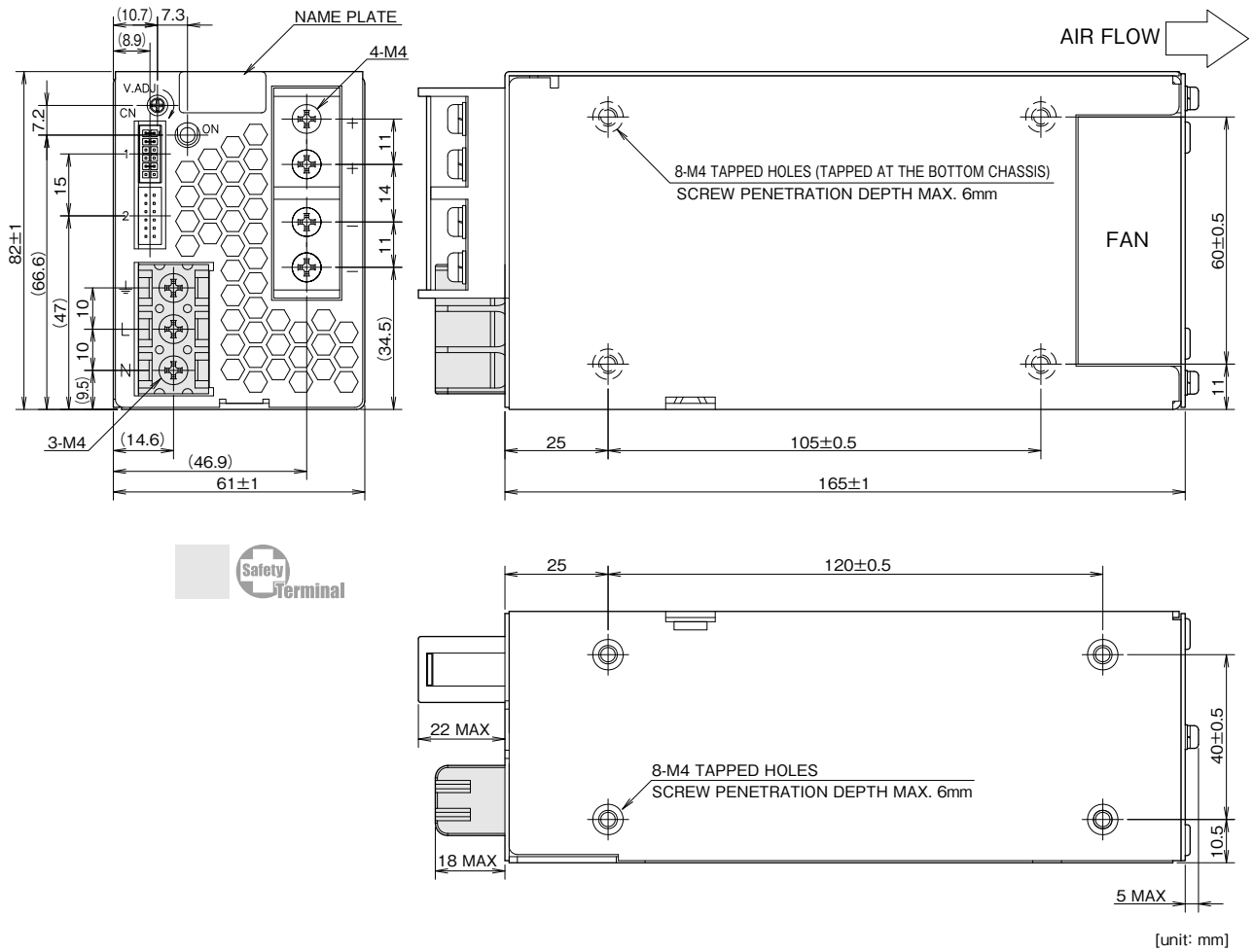

== SIGNAL CONNECTOR USED ==

PART DESCRIPTION	PART NAME	MANUFACT
PIN HEADER	S12B-PHDSS	JST

== MATCHING HOUSINGS, PINS & TOOL ==

PART DESCRIPTION	PART NAME	MANUFACT
SOCKET HOUSING	PHDR-12VS	JST
TERMINAL PINS	SPHD-002T-P0.5(AWG28~24) SPHD-001T-P0.5(AWG26~22)	JST
HAND CRIMPING TOOL	YRS-620(SPHD-002T-P0.5) YC-610R(SPHD-001T-P0.5)	JST

== ACCESSORIES ==

- *COVER FOR BARRIER TERMINAL STRIP -----1 (ATTACHED ON TERMINAL AT SHIPMENT)
- *SHORT PIECE -----1 (SHORTING +Vm—+S, -Vm—-S, CNT—TOG (ATTACHED ON CN1 AT SHIPMENT))

Output Derating

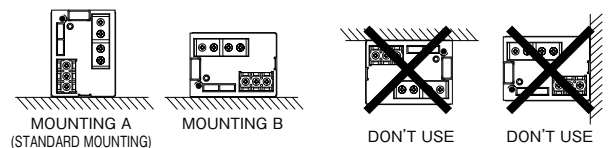
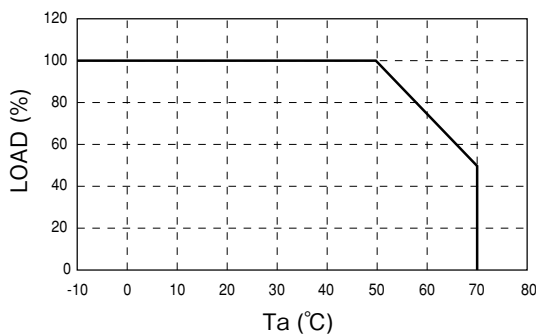

HWS600/ME Specifications (Read instruction manual carefully, before using the power supply unit.)

ITEMS/UNITS		MODEL	HWS600-5/ME	HWS600-12/ME	HWS600-15/ME	HWS600-24/ME	HWS600-48/ME
Input	Voltage Range (*3)	V	AC85 - 265 or DC120 - 330				
	Frequency (*3)	Hz	47 - 63				
	Power Factor (100/200VAC)(typ) (*2)		0.99 / 0.95				
	Efficiency (100/200VAC)(typ) (*2)	%	80/83		81/84	82/85	83/86
	Current (100/200VAC)(typ) (*2)	A	7.5/3.6	8.1 / 3.9			
	Inrush Current (100/200VAC)(typ)	A	20 / 40				
Leakage Current (*11)	mA	Less than 0.5. (0.12 (typ) at 100VAC / 0.34 (typ) at 230VAC)					
Output	Nominal Voltage	VDC	5	12	15	24	48
	Maximum Current (*1)	A	120	53	43	27 (31)	13
	Maximum Power	W	600	636	645	648	624
	Maximum Line Regulation (*6)	mV	20	48	60	96	192
	Maximum Load Regulation (*7)	mV	30	72	90	144	288
	Temperature Coefficient (%)		Less than 0.02% / ° C				
	Maximum Ripple & Noise (0≤Ta≤70° C) (*5)	mVp-p	120	150			350
	Maximum Ripple & Noise (-10≤Ta< 0° C) (*5)	mVp-p	180	200			400
	Hold-up Time (typ) (*10)	ms	20				
Function	Voltage Adjustable Range	VDC	4.0 - 6.0	9.6 - 14.4	12.0 - 18.0	19.2 - 28.8	38.4 - 52.8
	Over Current Protection (*8)	A	>126	>55.7	>45.2	>31.4	>13.7
	Over Voltage Protection (*9)	VDC	6.25 - 7.25	15.0 - 17.4	18.8 - 21.8	30.0 - 34.8	55.2 - 64.8
	Remote Sensing		Possible				
	Remote ON/OFF Control		Possible				
	Parallel Operation		Possible				
	Series Operation		Possible				
	Monitoring Signal		PF (Open collector output)				
	Line DIP		Designed to meet SEMI-F47 (200VAC Line only)				
	Environment	Operating Temperature (*12)	°C	-10 to +70 (-10 +50: 100%, +70: 50%)			
Storage Temperature		°C	-30 to +85				
Operating Humidity		%RH	10 - 90 (No dewdrop)				
Storage Humidity		%RH	10 - 95 (No dewdrop)				
Vibration			At no operating, 10 - 55Hz (sweep for 1min) 19.6m/s ² constant, X,Y,Z 1hour each.				
Shock (In package)			Less than 196.1m/s ²				
Cooling			Forced air by blower fan				
Isolation	Withstand Voltage		Input - FG : 2.5kVAC (20mA), Input - Output : 3kVAC (20mA) Output - FG : 500VAC (100mA), Output - CNT : 100VAC (100mA) for 1min				
	Isolation Resistance		More than 100MΩ Output - FG : 500VDC More than 10MΩ Output - CNT : 100VDC at 25° C and 70%RH				
Standards	Safety Standards (*13)		Approved by UL60601-1, EN60601-1, CSA-C22.2 No601.1-M90				
	PFHC		Designed to meet IEC61000-3-2				
	Voltage Fluctuations / Flicker Emissions		Designed to meet IEC61000-3-3				
	EMI		Designed to meet EN55011/EN55022-A, FCC-A, VCCI-A				
Mechanical	Immunity		Designed to meet IEC61000-4-2(Level 3), -3(Level 3), -4(Level 3), -5(Level 3,4), -6(Level 3), -8(Level 4), -11				
	Weight (typ)	g	1600				
	Size (W x H x D)	mm	100 x 82 x 165 (Refer to outline drawing)				

(*1) () : Peak output current at 200VAC. Operating time at peak output is less than 10 sec, duty is less than 35%.

(*2) At 100/200VAC, Ta=25° C and maximum output power.

(*3) For cases where conformance to various safety specs (UL, CSA, EN) are required, to be described as 100 - 240VAC (50/60Hz).

(*4) Not applicable for the inrush current to noise filter for less than 0.2ms.
Inrush current is 30A (typ) when PFHC start-up.

(*5) Measure with JEITA RC-9131A probe, bandwidth of scope: 100MHz.

(*6) 85 - 265VAC, constant load.

(*7) No load - full load, constant input voltage.

(*8) Constant current limit with automatic recovery.
Avoid to operate at over load or short circuit condition for more than 30 seconds.

(*9) OVP circuit will shut the output down, manual reset (CNT reset or re-power on).

(*10) At 100/200VAC, nominal output voltage and maximum output current.

(*11) Measured by the each measuring method of UL, EN, and CSA (at 60Hz), Ta=25° C.
When using it as a patient care equipment, all outer surfaces of the equipment shall be constructed of nonconductive material. See clause 19.5DV.2 of UL60601-1.

(*12) Ratings - Derating at standard mounting. Refer to output derating curve.
- Load (%) is percent of maximum output power or maximum output current, whichever is greater.

(*13) As for UL60601-1, EN60601-1 and CSA-C22.2 No601.1-M90, basic insulation.

Recommended EMC Filter



RSEN-2006L

Please refer to "TDK-Lambda EMC Filters" catalog.

HWS

HWS HD

HWS ME

HWS-P

Instruction Manual

Outline Drawing

[HWS600/ME]

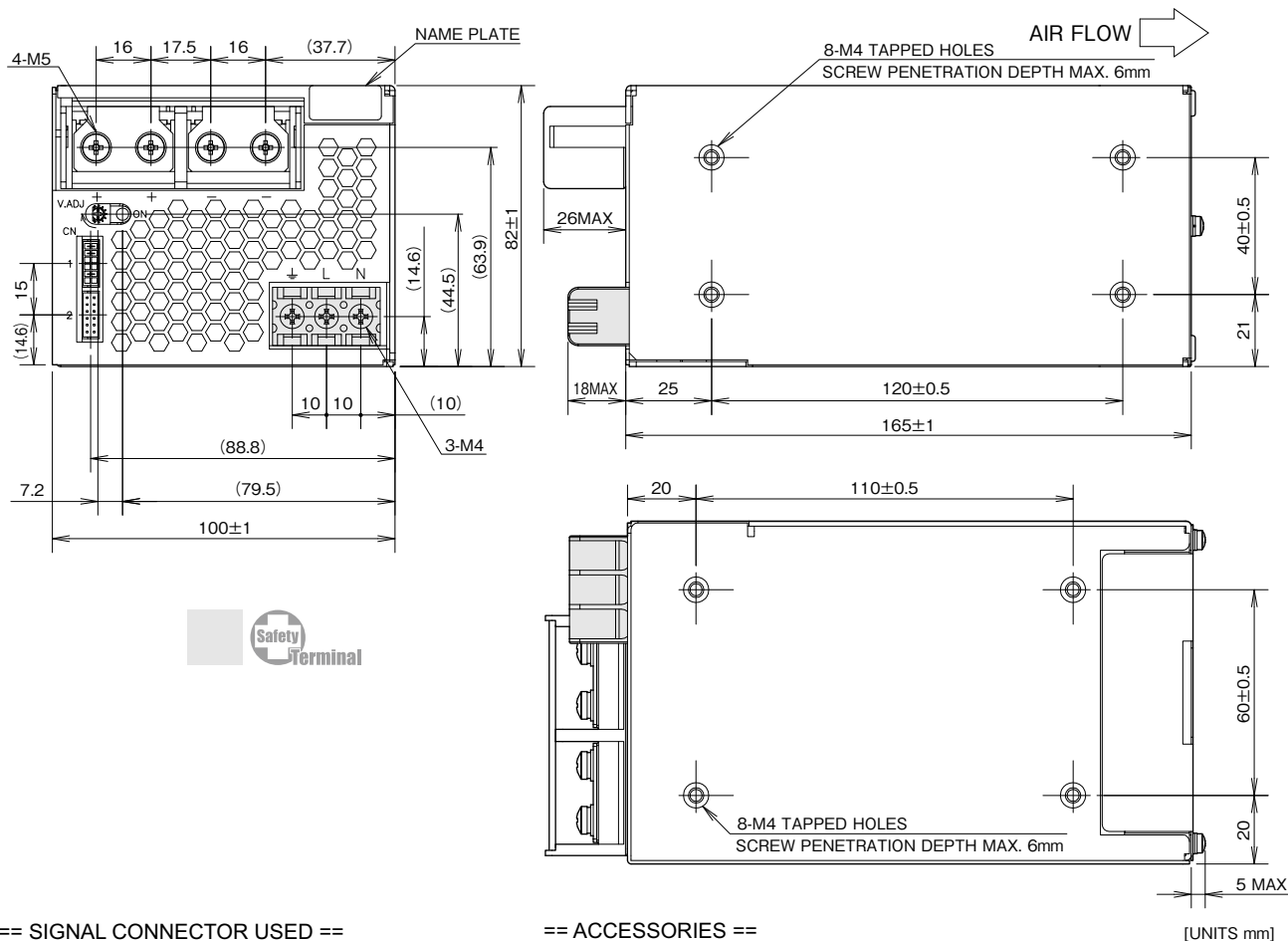

== SIGNAL CONNECTOR USED ==

PART DESCRIPTION	PART NAME	MANUFACT
PIN HEADER	S12B-PHDSS	JST

== MATCHING HOUSINGS, PINS & TOOL ==

PART DESCRIPTION	PART NAME	MANUFACT
SOCKET HOUSING	PHDR-12VS	JST
TERMINAL PINS	SPHD-002T-P0.5(AWG28~24) SPHD-001T-P0.5(AWG26~22)	JST
HAND CRIMPING TOOL	YRS-620(SPHD-002T-P0.5) YC-610R(SPHD-001T-P0.5)	JST

== ACCESSORIES ==

- *COVER FOR BARRIER TERMINAL STRIP -----1
(ATTACHED ON TERMINAL AT SHIPMENT)
- *SHORT PIECE -----1
SHORTING +Vm—+S, -Vm—-S, CNT—TOG
(ATTACHED ON CN1 AT SHIPMENT)

[UNITS mm]

Output Derating

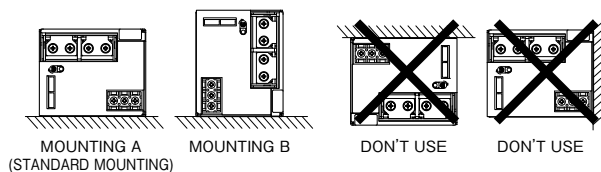
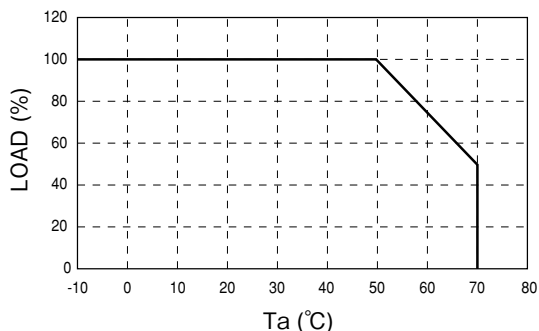

HWS1000/ME Specifications (Read instruction manual carefully, before using the power supply unit.)

ITEMS/UNITS		MODEL	HWS1000-24/ME	HWS1000-36/ME	HWS1000-48/ME	
Input	Voltage Range (*2)	V	AC85 - 265 or DC120 - 330			
	Frequency (*2)	Hz	47 - 63			
	Power Factor (100/200VAC)(typ) (*1)		0.98/0.95			
	Efficiency (100/200VAC)(typ) (*1)	%	85/87	85/88	86/88	
	Current (100/200VAC)(typ) (*1)	A	13.5/7.0			
	Inrush Current (100/200VAC)(typ) (*3)	A	20/40			
Leakage Current (*10)	mA	Less than 0.5 (0.2(Typ) at 100VAC / 0.4(typ) at 230VAC)				
Output	Nominal Voltage	VDC	24	36	48	
	Maximum Current	A	46	30.7	23	
	Maximum Peak Current (*13)	A	58.5	39	29.2	
	Maximum Power	W	1104			
	Maximum Peak Power (*13)	W	1404			
	Maximum Line Regulation (*5)	mV	96	144	192	
	Maximum Load Regulation (*6)	mV	150			
	Temperature Coefficient		Less than 0.02%/°C			
	Maximum	0 to +71°C	mVp-p	150	200	
	Ripple & Noise (*4)	-10 to 0°C	mVp-p	180	240	500
	Hold-up Time (typ) (*9)	ms	20			
Voltage Adjustable Range	VDC	19.2-28.8	28.8-43.2	38.4-52.8		
Function	Over Current Protection (*7)	A	>61.4	>40.9	>30.6	
	Over Voltage Protection (*8)	VDC	30.0-34.8	45.0-49.7	55.2-60.0	
	Remote Sensing		Possible			
	Remote ON/OFF Control		Possible			
	Parallel Operation		Possible			
	Series Operation		Possible			
	Monitoring Signal		PF(Open collector output)			
	Line DIP		Built to meet SEMI-F47 (200VAC Line only)			
Environment	Operating Temperature (*11)	°C	-10 to +71, Start up -20 to +71			
		-10 to +40°C	%	100		
		+50°C	%	100		
		+71°C	%	50		
	Storage Temperature	°C	-30 to +85			
	Operating Humidity	%RH	10 - 90 (No Condensing)			
	Storage Humidity	%RH	10 - 95 (No Condensing)			
	Vibration		At no operating, 10 - 55Hz (Sweep for 1min.) 19.6m/s ² Constant, X,Y,Z 1hour each.			
Shock (In package)		Less than 196.1m/s ²				
Cooling		Forced Air By Blower Fan				
Isolation	Withstand Voltage		Input - FG : 2kVAC (20mA), Input - Output : 3kVAC (20mA) Output-FG : 500VAC (300mA), Output-CNT:100VAC (100mA) for 1min.			
	Isolation Resistance		More than 100MΩ Output - FG : 500VDC More than 10MΩ Output - CNT : 100VDC at 25°C and 70%RH			
Standards	Safety Standards (*12)		Approved by UL60601-1, EN60601-1,CSA C22.2 No.601.1-M90(C-UL)			
	PFHC		Built to meet IEC61000-3-2			
	Voltage Fluctuations/Flicker Emissions		Built to meet IEC61000-3-3			
	EMI		Built to meet EN55011/EN55022-A, FCC-ClassA, VCCI-ClassA, CISPR-ClassA.			
Mechanical	Immunity		Built to meet IEC61000-4-2(Level 2,3), -3(Level 3), -4(Level 3), -5(Level 3,4), -6(Level 3), -8(Level 4), -11			
	Weight (max)	g	3200			
	Size (W×H×D)	mm	126.5 x 82 x 240 (Refer to Outline Drawing)			

(*1) At Ta=25°C and maximum output power.

(*2) For cases where conformance to various safety specs (UL, CSA, EN) are required, input voltage range will be 100 - 240VAC(50/60Hz).

(*3) First in-rush current. Not applicable to the first 0.2ms in-rush current flowing into the power supply noise filter.

(*4) Measure with JEITA RC-9131A probe, Bandwidth of scope :100MHz. (at 100uF electric capacitor and 0.47uF film capacitor on the test fixture board.)

(*5) 85 - 265VAC , constant load.

(*6) No load-Full load, constant input voltage.

(*7) Constant current limit with automatic recovery. Over current condition for more than 5 seconds will cause the output to shutdown.
Output current exceeding maximum rated output current for more than 10 seconds continuously will result to output shutdown.

(*8) OVP circuit will shut down output, manual reset (Power cycle) or ON/OFF CNT signal reset.

(*9) At 100/200VAC, nominal output voltage and maximum output current.

(*10) Measured by the each measuring method of UL, CSA, EN and DENAN (at 60Hz), Ta=25°C.
When using it as a patient care equipment, all outer surfaces of the equipment shall be constructed of nonconductive material. See clause 19.5DV.2 of UL60601-1.

(*11) Ratings - Derating at standard mounting.
- Load (%) is percent of maximum output power or maximum output current, whichever is greater.
- As for other mountings, refer to derating curve.

(*12) As for UL60601-1, EN60601-1 and CSA-C22.2 No.601.1-M90(C-UL) basic insulation.

(*13) Peak output current is less than 10 seconds, and duty 35% max. (200VAC Line only)

Recommended EMC Filter



RSEN-2006L
Please refer to "TDK-Lambda EMC Filters" catalog.

Outline Drawing

[HWS1000/ME]

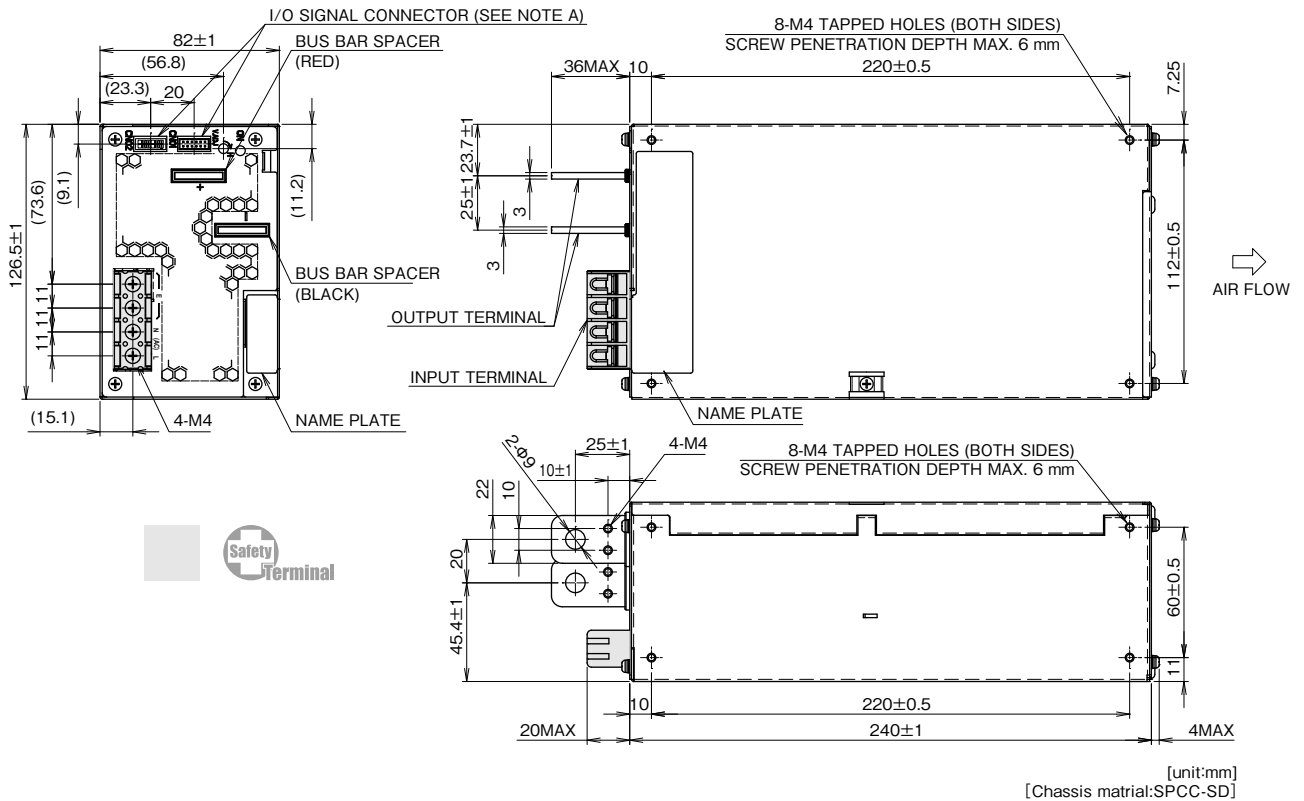

NOTES

- A : I/O SIGNAL CONNECTOR
- | | | |
|--------------------|------------------------------|----------|
| CONNECTOR | : S12B-PHDSS(LF)(SN) | (JST) |
| MATCHING HOUSING | : PHDR-12VS | (JST) |
| MATCHING CONTACT | : SPHD-002T-P0.5(AWG28 ~ 24) | (JST) OR |
| | SPHD-001T-P0.5(AWG26 ~ 22) | (JST) OR |
| | BPHD-001T-P0.5(AWG26 ~ 22) | (JST) |
| HAND CRIMPING TOOL | : YRS-620(SPHD-002T-P0.5) | (JST) |
| | YC-610R(SPHD-001T-P0.5) | (JST) |
| | YC-610R(BPHD-001T-P0.5) | (JST) |

ACCESSORIES

- * ATTACHED CONNECTOR
SHORTING +S ~ +V, -S ~ -V, PV ~ REF & CNT ~ TDG
ATTACHED ON CN02 AT SHIPMENT
- * A separate connector not included is required in order to utilize the power supply function.

Output Derating

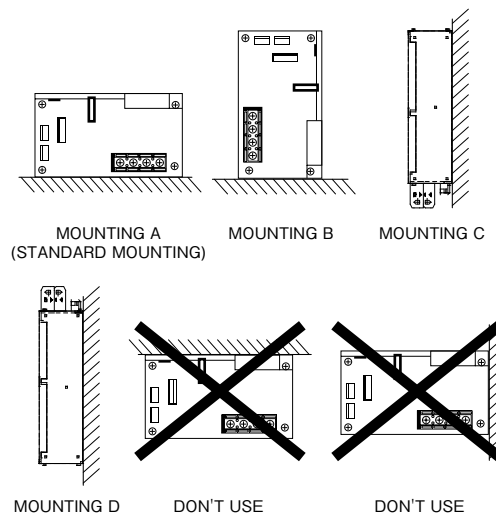
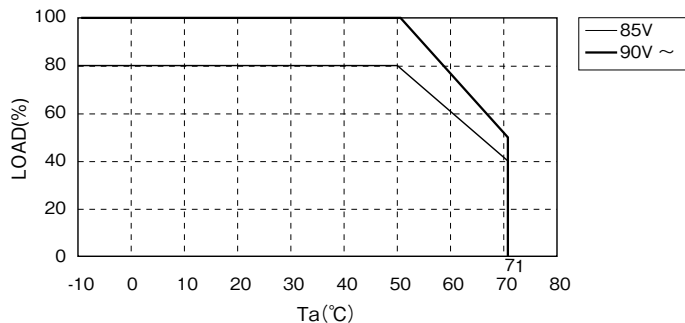

*It cannot be used even the product is flipped vertically.

HWS1500/ME Specifications (Read instruction manual carefully, before using the power supply unit.)

ITEMS/UNITS		MODEL	HWS1500-24/ME	HWS1500-36/ME	HWS1500-48/ME	
Input	Voltage Range (*2)	V	AC85 - 265			
	Frequency (*2)	Hz	47 - 63			
	Power Factor (100/230VAC)(typ)(*1)		0.98 / 0.94			
	Efficiency (100/200VAC)(typ) (*1)	%	84 / 88		86 / 90	
	Current (100/200VAC)(typ) (*1)	A	19.0 / 10.0			
	Inrush Current (100/200VAC)(typ)(*3)	A	20 / 40			
	Leakage Current (*10)	mA	Less than 0.5. (0.2 (typ) at 100VAC / 0.4 (typ) at 230VAC)			
Output	Nominal Voltage	VDC	24	36	48	
	Maximum Current (100/200VAC)	A	65 / 70	42 / 46.5	32 / 32	
	Maximum Peak Current (*13)	A	105	70	-	
	Maximum Power (100/200VAC)	W	1560 / 1680	1512 / 1674	1536 / 1536	
	Maximum Peak Power (*13)	W	2520		-	
	Maximum Line Regulation (*5)	mV	96	144	192	
	Maximum Load Regulation (*6)	mV	144	150	288	
	Temperature Coefficient		Less than 0.02%/°C			
	Maximum	0 to +70°C	200			
	Ripple & Noise (*4)	-10 to 0°C	240		400	
	Hold-up Time (typ)	(*9)	20			
	Voltage Adjustable Range	VDC	19.2 - 28.8	28.8 - 43.2	38.4 - 52.8	
	Function	Over Current Protection (*7)	A	>110.2	>73.5	>33.6
Over Voltage Protection (*8)		VDC	30.0 - 34.8	45.0-49.7	55.2 - 64.8	
Remote Sensing			Possible			
Remote ON/OFF Control			Possible			
Parallel Operation			Possible			
Series Operation			Possible			
Monitoring Signal			PF (Open collector output)			
Line DIP			Built to meet SEMI-F47 (200VAC Line only)			
Operating Temperature (*11)		°C	-10 to +70 (-10 to +50: 100%, +60: 75%, +70: 50%), start up -20 to 70			
Storage Temperature		°C	-30 to +85			
Environment	Operating Humidity	%RH	10 - 90 (No Condensing)			
	Storage Humidity	%RH	10 - 95 (No Condensing)			
	Vibration		At no operating, 10 - 55Hz (sweep for 1min.) 19.6m/s ² constant, X, Y, Z 1hour each.			
	Shock (In package)		Less than 196.1m/s ²			
	Cooling		Forced air by blower fan			
	Isolation	Withstand Voltage		Input - FG : 2kVAC (20mA), Input - Output : 3kVAC (20mA) Output-FG : 500VAC (300mA), Output-CNT:100VAC (100mA) for 1min.		
		Isolation Resistance		More than 100MΩ Output - FG : 500VDC More than 10MΩ Output - CNT : 100VDC at 25°C and 70%RH		
Standards	Safety Standards (*12)		Approved by UL60601-1, EN60601-1, CSA C22.2 No.601.1-M90 (C-UL)			
	PFHC		Built to meet IEC61000-3-2			
	Voltage Fluctuations / Flicker Emissions		Built to meet IEC61000-3-3			
	EMI		Approved by EN55011 / EN55022-A, FCC-Class A, VCCI-Class A			
Mechanical	Immunity		Built to meet IEC61000-4-2(Level 2,3), -3(Level 3), -4(Level 3), -5(Level 3,4), -6(Level 3), -8(Level 4), -11			
	Weight (typ)	g	3800			
	Size (W x H x D)	mm	126.5 x 82 x 280 (Refer to outline drawing)			

- (*1) At Ta=25°C and maximum output power.
- (*2) For cases where conformance to various safety specs (UL, CSA, EN) are required, input voltage range will be 100 - 240VAC (50/60Hz).
- (*3) First in-rush current. Not applicable to the first 0.2ms in-rush current flowing into the power supply noise filter.
- (*4) Measure with JEITA RC-9131A probe, Bandwidth of scope :100MHz. (at 100uF electric capacitor and 0.47uF film capacitor on the test fixture board.)
- (*5) 85 - 265VAC, constant load.
- (*6) No load-Full load, constant input voltage.
- (*7) Constant current limit with automatic recovery. Over current condition for more than 5 seconds will cause the output to shutdown.
Output current exceeding maximum rated output current for more than 10 seconds continuously will result to output shutdown.
- (*8) OVP circuit will shut down output, manual reset (Power cycle) or ON/OFF CNT signal reset.
- (*9) At 100/200VAC, nominal output voltage and maximum output current.
- (*10) Measured by the each measuring method of UL, EN and CSA (at 60Hz).
When using it as a patient care equipment, all outer surfaces of the equipment shall be constructed of nonconductive material. See clause 19.5DV.2 of UL60601-1.
- (*11) Ratings - Derating at standard mounting.
- Load (%) is percent of maximum output power or maximum output current, whichever is greater.
- As for other mountings, refer to derating curve.
- (*12) As for UL60601-1, EN60601-1 and CSA-C22.2 No.601.1-M90 (C-UL) basic insulation.
- (*13) Peak output current is less than 10 seconds, and duty 35% max. (200VAC Line only)

● Recommended EMC Filter



RSEN-2030L

Please refer to "TDK-Lambda EMC Filters" catalog.

HWS

HWS HD

HWS ME

HWS-P

Instruction Manual

Outline Drawing

[HWS1500/ME]

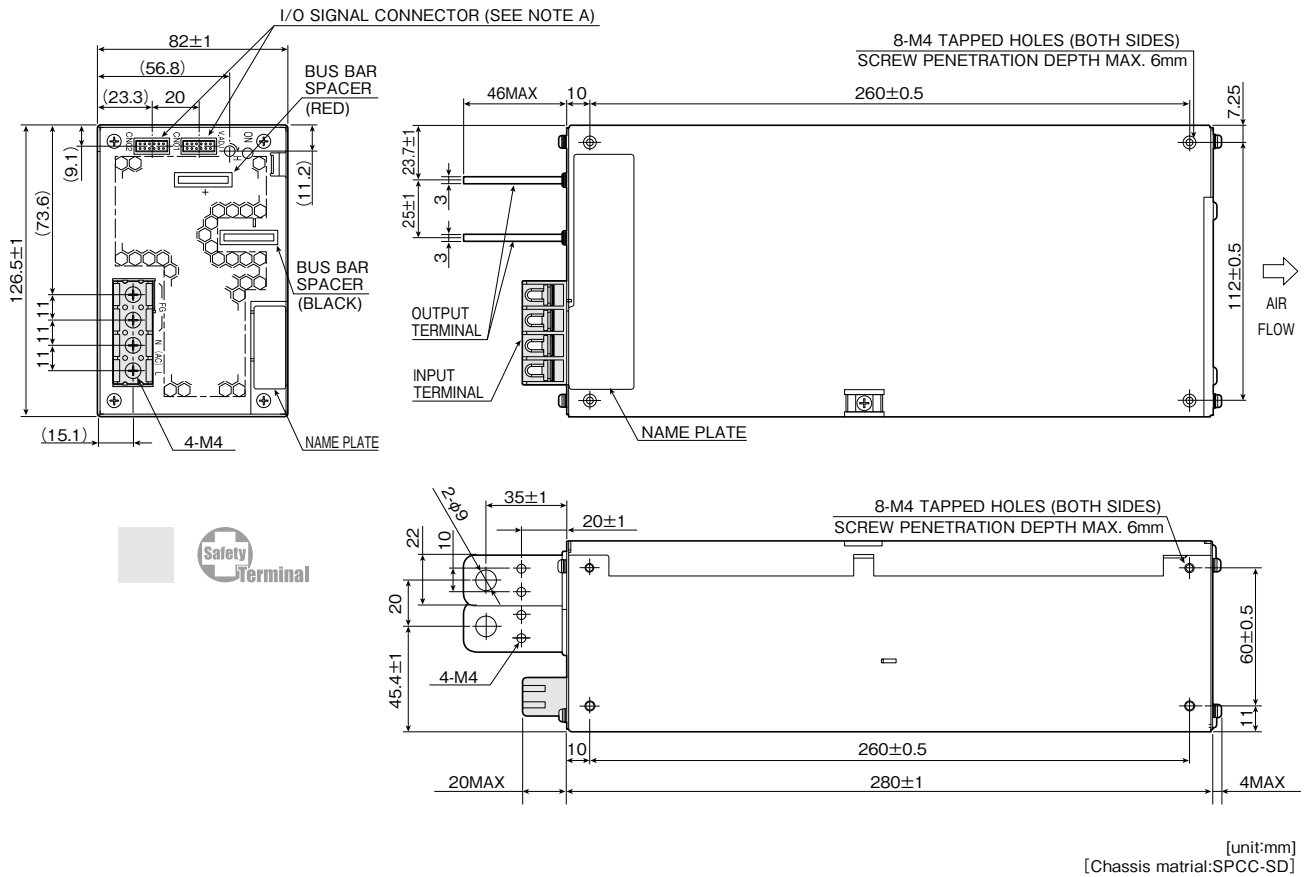

NOTES

A : I/O SIGNAL CONNECTOR

- CONNECTOR : S12B-PHDSS(LF)(SN) (JST)
- MATCHING HOUSING : PHDR-12VS (JST)
- MATCHING CONTACT : SPHD-002T-P0.5(AWG28 ~ 24) (JST) OR
 SPHD-001T-P0.5(AWG26 ~ 22) (JST) OR
 BPHD-001T-P0.5(AWG26 ~ 22) (JST)
- HAND CRIMPING TOOL : YRS-620(SPHD-002T-P0.5) (JST)
 YC-610R(SPHD-001T-P0.5) (JST)
 YC-610R(BPHD-001T-P0.5) (JST)

ACCESSORIES

- * ATTACHED CONNECTOR
 SHORTING +S ~ +V, -S ~ -V, PV ~ REF & CNT ~ TDG
 ATTACHED ON CN01 AT SHIPMENT
- * A separate connector not included is required in order to utilize the power supply function.

Output Derating

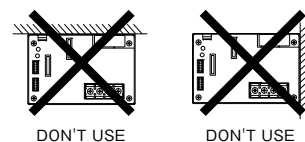
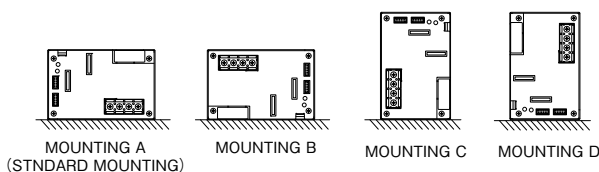
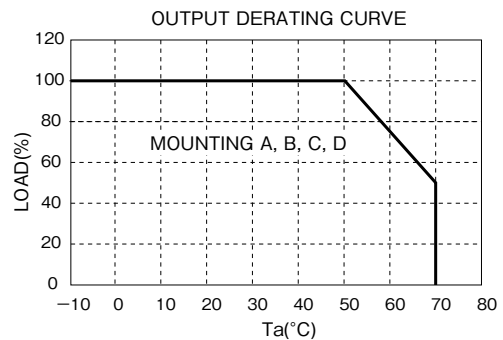
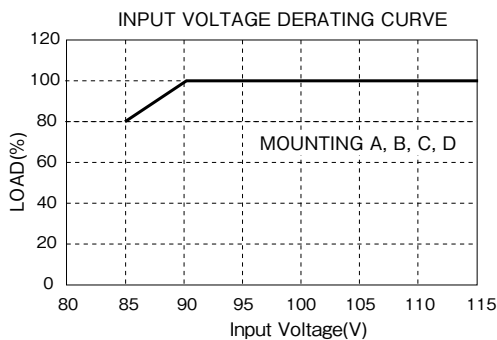

*It cannot be used even the product is flipped vertically.

TDK·Lambda

HWS-P

Single Output 300W ~ 600W



■ Features

- Single output pulse power type in wide range input power supply.
- Up to 3 times peak current.
- Full Load (100%) Capability at 50°C operating temperature

■ Model naming method

HWS 300P – 24

Series name

Nominal output voltage

ex. 24: 24V, 36: 36V, 48: 48V

Output Power

ex. 300P: 300W, 600P: 600W

■ Applications



■ Conformity to RoHS Directive

This means that, in conformity with EU Directive 2002/95/EC, lead, cadmium, mercury, hexavalent chromium, and specific bromine-based flame retardants, PBB and PBDE, have not been used, except for exempted applications.

■ Product Line up

Output Voltage	HWS300P				HWS600P			
	Ave. Output Current	Peak Output Current		Ave. Output Current	Peak Output Current			
		100V in	200V in		100V in	200V in		
24V	12.5A	21.0A	42.0A	25.0A	40.5A	83.0A		
36V	8.4A	14.0A	28.0A	16.7A	27.0A	55.5A		
48V	6.3A	10.5A	21.0A	12.5A	20.0A	41.5A		

(*) (100Vin/200Vin)

HWS300P Specifications

ITEMS/UNITS		MODEL	HWS300P-24	HWS300P-36	HWS300P-48
Input	Voltage Range (*3)	V	85 - 265VAC or 120 - 330VDC		
	Frequency	Hz	47 - 63		
	Power Factor (100/200VAC)(Typ) (*2)		0.99/0.93		
	Efficiency (100VAC)(Typ) (*2)	%	84		
	Efficiency (200VAC)(Typ) (*2)	%	87		
	Current (100/200VAC)(Typ) (*2)	A	3.6/1.9		
	Inrush Current (100/200VAC)(Typ) (*4)	A	20 / 40		
Leakage Current (*11)	mA	Less than 0.75mA. (0.2(Typ) at 100VAC / 0.44(Typ) at 230VAC)			
Output	Nominal Voltage	VDC	24	36	48
	Average Current	A	12.5	8.4	6.3
	Maximum Peak Current (100VAC/200VAC) (*1)	A	21/42	14/28	10.5/21
	Average Power	W	300	302.4	
	Maximum Peak Power (100VAC) (*1)	W	504		
	Maximum Peak Power (200VAC) (*1)	W	1008		
	Maximum Line Regulation (*6)	mV	96	144	192
	Maximum Load Regulation (*7)	mV	144	216	288
	Temperature Coefficient		Less than 0.02% / °C		
	Maximum Ripple & Noise (0≤Ta≤70° C) (*5)	mVp-p	150	200	350
	Maximum Ripple & Noise (-10≤Ta<0° C) (*5)	mVp-p	200	250	400
	Hold-up Time (Typ) (*10)	ms	20ms		
	Voltage Adjustable Range	VDC	19.2 - 26.4	28.8 - 39.6	38.4 - 52.8
	Function	Over Current Protection (100VAC) (*8)	A	>21.4	>14.3
Over Current Protection (200VAC) (*8)		A	>42.8	>28.6	>21.4
Over Voltage Protection (*9)		VDC	27.6 - 32.4	41.4 - 48.6	55.2 - 64.8
Remote Sensing			-		
Remote ON/OFF Control			Possible		
Parallel Operation			-		
Series Operation			Possible		
Monitoring Signal			PF(Open Collector Output)		
Line DIP			Designed to meet SEMI-F47 (200VAC Line only)		
Environment		Operating Temperature (*12)	°C	-10 - +70(-10 - +50:100%,+70:50%)	
	Storage Temperature	°C	-30 - +85		
	Operating Humidity	%RH	10 - 90 (No dewdrop)		
	Storage Humidity	%RH	10 - 95 (No dewdrop)		
	Vibration		At no operating, 10 - 55Hz (Sweep for 1min) 19.6m/s ² Constant, X,Y,Z 1hour each		
	Shock (In package)		Less than 196.1m/s ²		
	Cooling		Forced Air By Blower Fan		
Isolation	Withstand Voltage		Input - FG : 2.5kVAC (20mA), Input - Output : 3kVAC (20mA) Output - FG: 500VAC (100mA), Output-CNT: 100VAC(100mA) for 1min		
	Isolation Resistance		More than 100MΩ Output - FG : 500VDC More than 10MΩ Output - CNT : 100VDC at 25° C and 70%RH		
Standards	Safety Standards (*13)		Approved by UL60950-1, CSA60950-1, EN60950-1, EN50178 Designed to meet DENAN		
	PFHC		Designed to meet IEC61000-3-2		
	EMI (*14)		Designed to meet EN55011/EN55022-B, FCC-B, VCCI-B		
	Immunity		Designed to meet IEC61000-4-2(Level 2,3), -3(Level 3), -4(Level 3), -5(Level 3,4), -6(Level 3), -8(Level 4), -11		
Mechanical	Weight (Typ)	g	1000		
	Size (W×H×D)	mm	61 x 82 x 165 (Refer to Outline Drawing)		

*Read instruction manual carefully, before using the power supply unit.

=NOTES=

(*1) Operating time at peak output is less than 5sec, duty is less than 35%. For details, refer to peak output condition.
When the peak output more than 5 sec is continued, the output is shut down, manual reset (CNT reset or Re power on).

(*2) At 100/200VAC, Ta=25°C and average output power.

(*3) For cases where conformance to various safety specs (UL, CSA, EN) are required, to be described as 100 - 240VAC(50/60Hz).

(*4) First inrush current. Not applicable for the inrush current to Noise Filter for less than 0.2ms.

(*5) Measure with JEITA RC-9131A probe, Bandwidth of scope :100MHz. At average output power.

(*6) 85 - 265VAC , constant load.

(*7) No load-Average load, constant input voltage.

(*8) OCP circuit will shut the output down, manual reset (CNT reset or Re power on).

(*9) OVP circuit will shut the output down, manual reset (CNT reset or Re power on).

(*10) At 100/200VAC , nominal output voltage and average output current.

(*11) Measured by the each measuring method of UL,CSA,EN and DENAN(at 60Hz), Ta=25°C.

(*12) Ratings - Derating at standard mounting. Refer to output derating curve.

- Load (%) is percent of average output power or average output current, whichever is greater.

(*13) As for DENAN, designed to meet at 100VAC.

(*14) At Ta=25° C and average output power.

Outline Drawing

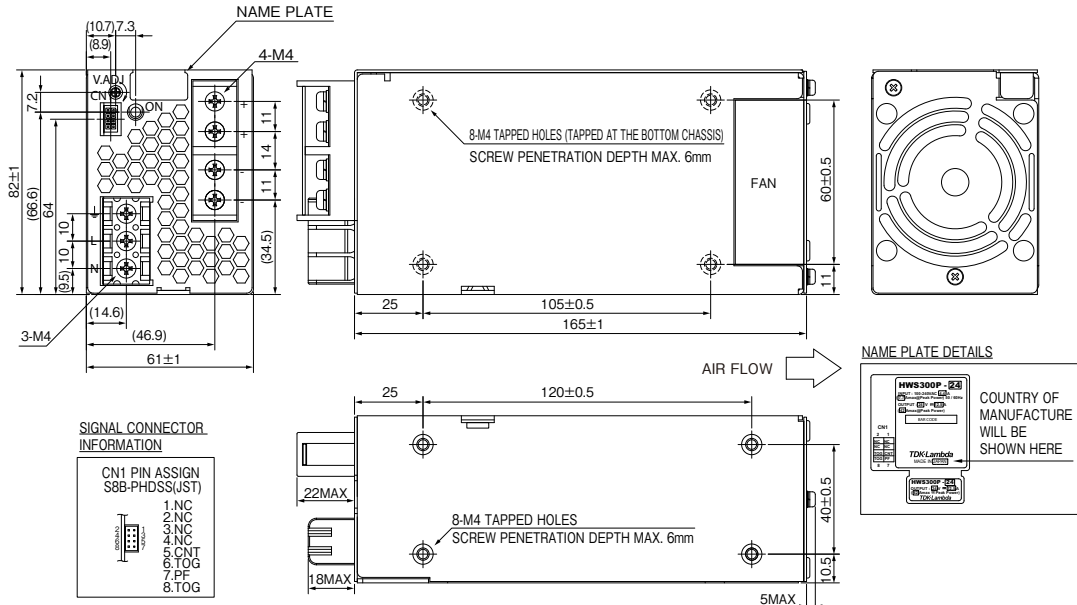

SIGNAL CONNECTOR USED

PART DESCRIPTION	PART NAME	MANUFACT
PIN HEADER	S8B-PHDSS	J.S.T.

MATCHING HOUSINGS , PINS & TOOL

PART DESCRIPTION	PART NAME	MANUFACT
SOCKET HOUSING	PHDR-08VS	J.S.T.
TERMINAL PINS	SPHD-002T-P0.5(AWG28~24) SPHD-001T-P0.5(AWG26~22)	J.S.T.
HAND CRIMPING TOOL	YRS-620(SPHD-002T-P0.5) YC-610R(SPHD-001T-P0.5)	J.S.T.

Output Derating

Ta (°C)	LOAD(%)	
	MOUNTING A	MOUNTING B
-10~+50	100	
70	50	

- (*1) Load(%) is percent of average output power or average output current.
For example, load 100% refers to following condition when output is 24V model.
24[V], 12.5[A]
- (*2) Peak output current does not need derating.

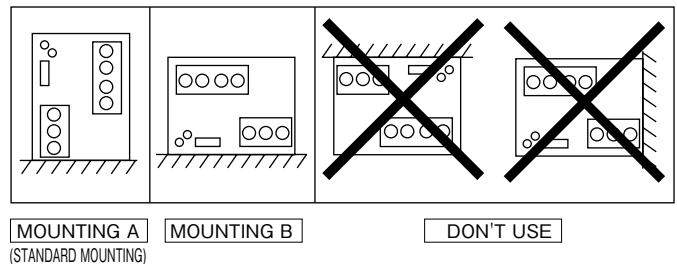
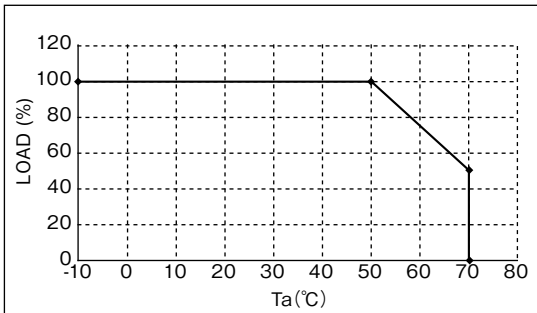

Peak Output Condition

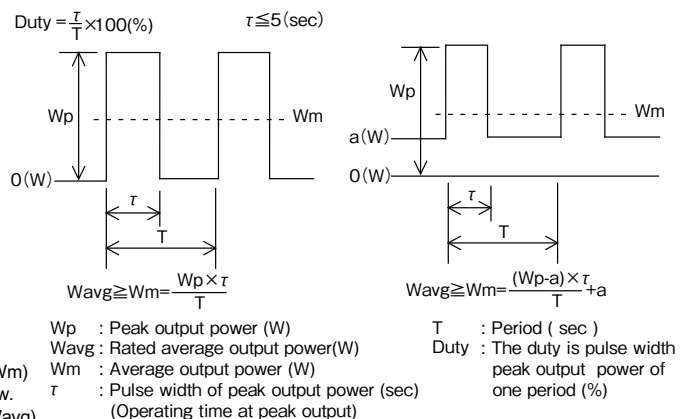
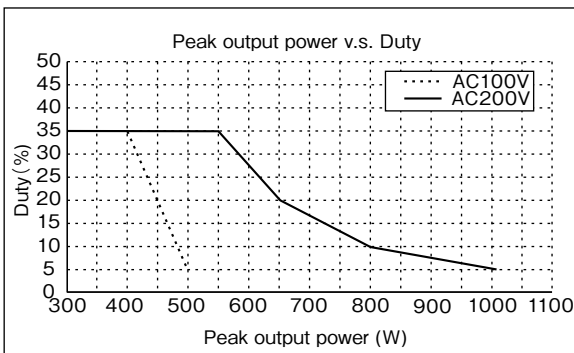

• All specifications are subject to change without notice.

HWS
HWS HD
HWS ME
HWS-P
Instruction Manual

HWS600P Specifications

ITEMS/UNITS		MODEL	HWS600P-24	HWS600P-36	HWS600P-48
Input	Voltage Range (*3)	V	85 - 265VAC or 120 - 330VDC		
	Frequency	Hz	47 - 63		
	Power Factor (100/200VAC)(Typ) (*2)		0.99/0.94		
	Efficiency (100VAC)(Typ) (*2)	%	84		
	Efficiency (200VAC)(Typ) (*2)	%	87		
	Current (100/200VAC)(Typ) (*2)	A	7.2/3.7		
	Inrush Current (100/200VAC)(Typ) (*4)	A	20 / 40		
Leakage Current (*11)	mA	Less than 0.75 (0.2(Typ) at 100VAC / 0.44(Typ) at 230VAC)			
Output	Nominal Voltage	VDC	24	36	48
	Average Current	A	25	16.7	12.5
	Maximum Peak Current (100VAC/200VAC) (*1)	A	40.5/83	27/55.5	20/41.5
	Average Power	W	600	601.2	600
	Maximum Peak Power (100VAC) (*1)	W	972		
	Maximum Peak Power (200VAC) (*1)	W	1992	1998	1992
	Maximum Line Regulation (*6)	mV	96	144	192
	Maximum Load Regulation (*7)	mV	144	216	288
	Temperature Coefficient		Less than 0.02% / ° C		
	Maximum Ripple & Noise (0≤Ta≤70° C) (*5)	mVp-p	150	200	350
	Maximum Ripple & Noise (-10≤Ta<0° C) (*5)	mVp-p	200	250	400
	Hold-up Time (Typ) (*10)	ms	20ms		
	Voltage Adjustable Range	VDC	19.2 - 26.4	28.8 - 39.6	38.4 - 52.8
	Function	Over Current Protection (100VAC) (*8)	A	>41.3	>27.5
Over Current Protection (200VAC) (*8)		A	>84.6	>56.6	>42.3
Over Voltage Protection (*9)		VDC	27.6 - 32.4	41.4 - 48.6	55.2 - 64.8
Remote Sensing			-		
Remote ON/OFF Control			Possible		
Parallel Operation			Possible (2 units Max)		
Series Operation			Possible		
Monitoring Signal			PF(Open Collector Output)		
Line DIP			Designed to meet SEMI-F47 (200VAC Line only)		
Environment		Operating Temperature (*12)	°C	-10 - +70 (-10 - +50:100%,+70:50%)	
	Storage Temperature	°C	-30 - +85		
	Operating Humidity	%RH	10 - 90 (No dewdrop)		
	Storage Humidity	%RH	10 - 95 (No dewdrop)		
	Vibration		At no operating, 10 - 55Hz (Sweep for 1min) 19.6m/s ² Constant, X,Y,Z 1hour each		
	Shock (In package)		Less than 196.1m/s ²		
	Cooling		Forced Air By Blower Fan		
Isolation	Withstand Voltage		Input - FG : 2.5kVAC (20mA), Input - Output : 3kVAC (20mA) Output - FG: 500VAC (100mA), Output-CNT: 100VAC(100mA) for 1min		
	Isolation Resistance		More than 100MΩ Output - FG : 500VDC More than 10MΩ Output -CNT : 100VDC at 25° C and 70%RH		
Standards	Safety Standards (*13)		Approved by UL60950-1, CSA60950-1, EN60950-1, EN50178 Designed to meet DENAN		
	PFHC		Designed to meet IEC61000-3-2		
	EMI (*14)		Designed to meet EN55011/EN55022-B, FCC-B, VCCI-B		
Mechanical	Immunity		Designed to meet IEC61000-4-2(Level 2,3), -3(Level 3), -4(Level 3), -5(Level 3,4), -6(Level 3,4), -8(Level 4), -11		
	Weight (Typ)	g	1600		
	Size (W×H×D)	mm	100 x 82 x 165 (Refer to Outline Drawing)		

*Read instruction manual carefully, before using the power supply unit.

=NOTES=

- (*1) Operating time at peak output is less than 5sec, duty is less than 35%. For details, refer to peak output condition.
When the peak output more than 5 sec is continued, the output is shut down, manual reset (CNT reset or Re power on).
- (*2) At 100/200VAC, Ta=25°C and average output power.
- (*3) For cases where conformance to various safety specs (UL, CSA, EN) are required, to be described as 100 - 240VAC(50/60Hz).
- (*4) First inrush current. Not applicable for the inrush current to Noise Filter for less than 0.2ms.
- (*5) Measure with JEITA RC-9131A probe, Bandwidth of scope :100MHz. At average output power.
- (*6) 85 - 265VAC , constant load.
- (*7) No load-Average load, constant input voltage.
- (*8) OCP circuit will shut the output down, manual reset (CNT reset or Re power on).
- (*9) OVP circuit will shut the output down, manual reset (CNT reset or Re power on).
- (*10) At 100/200VAC , nominal output voltage and average output current.
- (*11) Measured by the each measuring method of UL,CSA,EN and DENAN(at 60Hz), Ta=25°C.
- (*12) Ratings - Derating at standard mounting. Refer to output derating curve.
- Load (%) is percent of average output power or average output current, whichever is greater.
- (*13) As for DENAN, designed to meet at 100VAC.
- (*14) At Ta=25°C and average output power.

Outline Drawing

SIGNAL CONNECTOR INFORMATION

CN1 PIN ASSIGN
S8B-PHDS(SJT)

- 1.COM
- 2.PC
- 3.NC
- 4.NC
- 5.CNT
- 6.TOG
- 7.PF
- 8.TOG

NAME PLATE

AIR FLOW →

8-M4 TAPPED HOLES
SCREW PENETRATION DEPTH MAX. 6mm

8-M4 TAPPED HOLES
SCREW PENETRATION DEPTH MAX. 6mm

SIGNAL CONNECTOR USED

PART DESCRIPTION	PART NAME	MANUFACT
PIN HEADER	S8B-PHDS	J.S.T.

MATCHING HOUSINGS, PINS & TOOL

PART DESCRIPTION	PART NAME	MANUFACT
SOCKET HOUSING	PHDR-08VS	J.S.T.
TERMINAL PINS	SPHD-002T-P0.5(AWG28~24) SPHD-001T-P0.5(AWG26~22)	J.S.T.
HAND CRIMPING TOOL	YRS-620(SPHD-002T-P0.5) YC-610R(SPHD-001T-P0.5)	J.S.T.

Output Derating

Ta (°C)	LOAD(%)	
	MOUNTING A	MOUNTING B
-10~+50	100	
70	50	

(*1) Load(%) is percent of average output power or average output current.
For example, load 100% refers to following condition when output is 24V model.
24[V], 12.5[A]

(*2) Peak output current does not need derating.

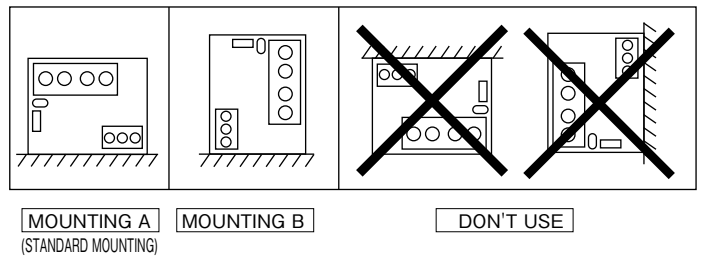
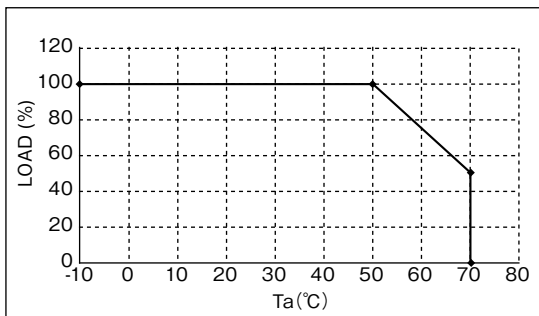

Peak Output Condition

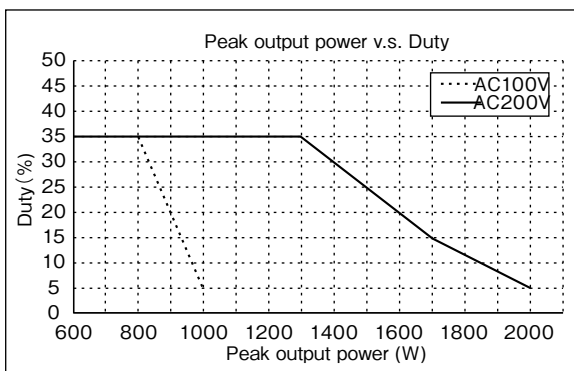

Duty = $\frac{\tau}{T} \times 100(\%)$ $\tau \leq 5(\text{sec})$

$$W_{avg} \geq W_m = \frac{W_p \times \tau}{T}$$

$$W_{avg} \geq W_m = \frac{(W_p - a) \times \tau}{T} + a$$

Wp : Peak output power (W) T : Period (sec)
 Wavg : Rated average output power(W) Duty : The duty is pulse width
 Wm : Average output power (W) peak output power of
 tau : Pulse width of peak output power (sec) one period (%)
 (Operating time at peak output)

Use this product so that relationship among Duty, average output power (Wm) and peak output power (Wp) satisfy conditions defined by expression below.
This product must be used less than average output power of specification (Wavg).
Also operating duration at peak output power should be less than 5 sec.

• All specifications are subject to change without notice.

HWS HWS HD HWS ME HWS-P Instruction Manual

Block Diagram

[HWS15, HWS30]

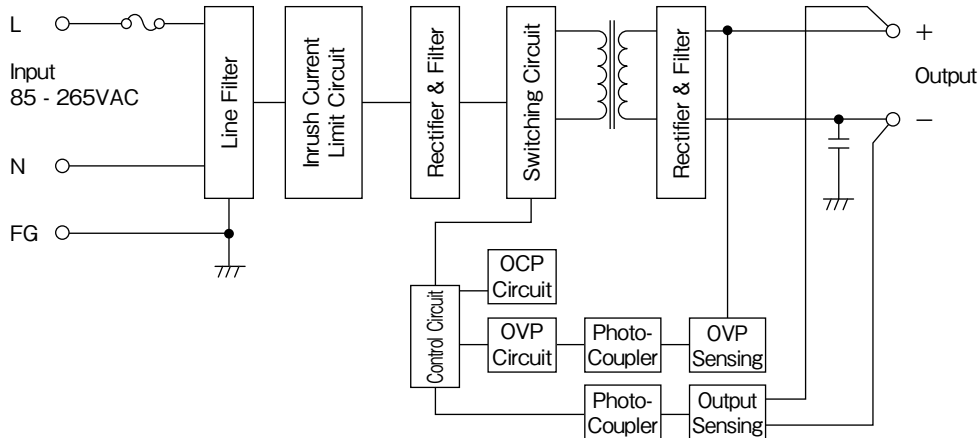

● Circuit topology, switching frequency
Flyback topology 70kHz (fixed)

● Fuse rating
HWS15 : 2A, HWS30 : 3.15A

[HWS50]

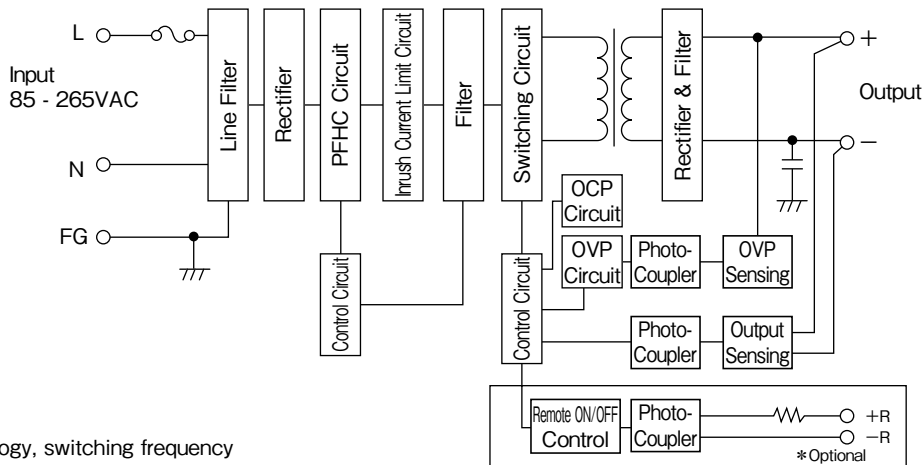

● Circuit topology, switching frequency
Single-ended forward topology 130kHz (fixed)
PFHC circuit : active filter 90kHz (fixed)

● Fuse rating : 2A

[HWS80, HWS100, HWS150]

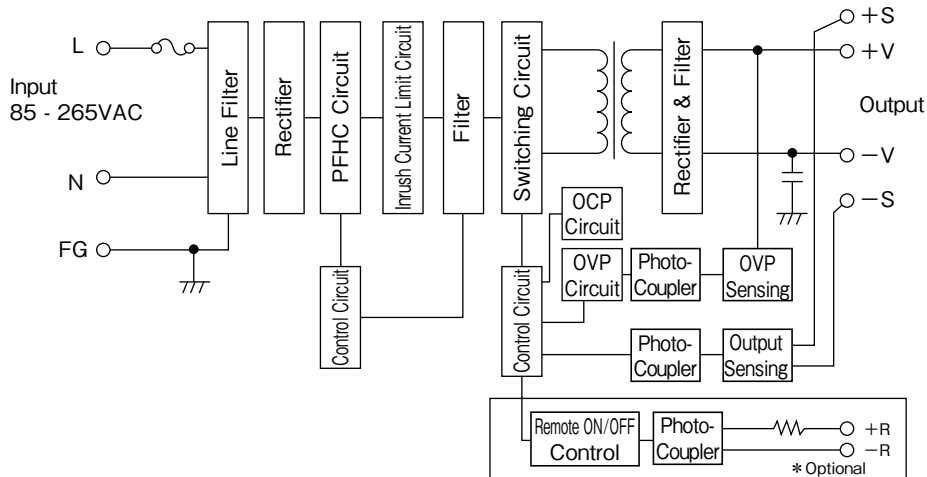

● Circuit topology, switching frequency
Cascade forward topology 120kHz (fixed)
PFHC circuit : active filter 80kHz (fixed)

● Fuse rating :
HWS80, HWS100 : 3.15A, HWS150 : 5A

Block Diagram

[HWS300, HWS600]

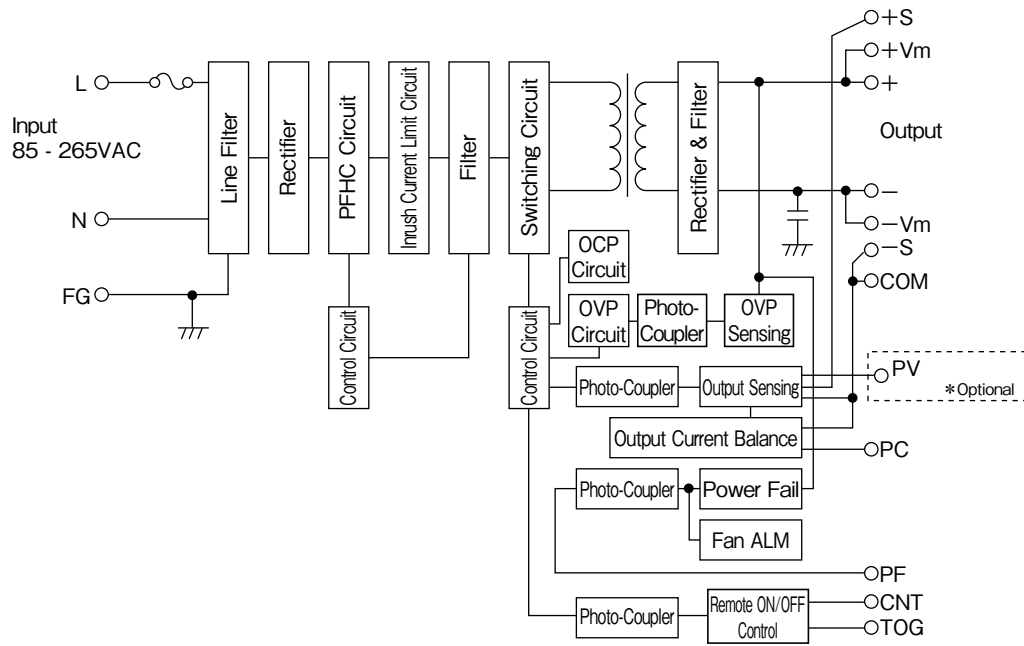

- Circuit topology, switching frequency
 Cascade forward topology 190kHz (fixed)
 PFHC circuit : active filter
 HWS300 : 80kHz (fixed), HWS600 : 90kHz (fixed)

- Fuse rating :
 HWS300 : 10A, HWS600 : 15A

[HWS1000]

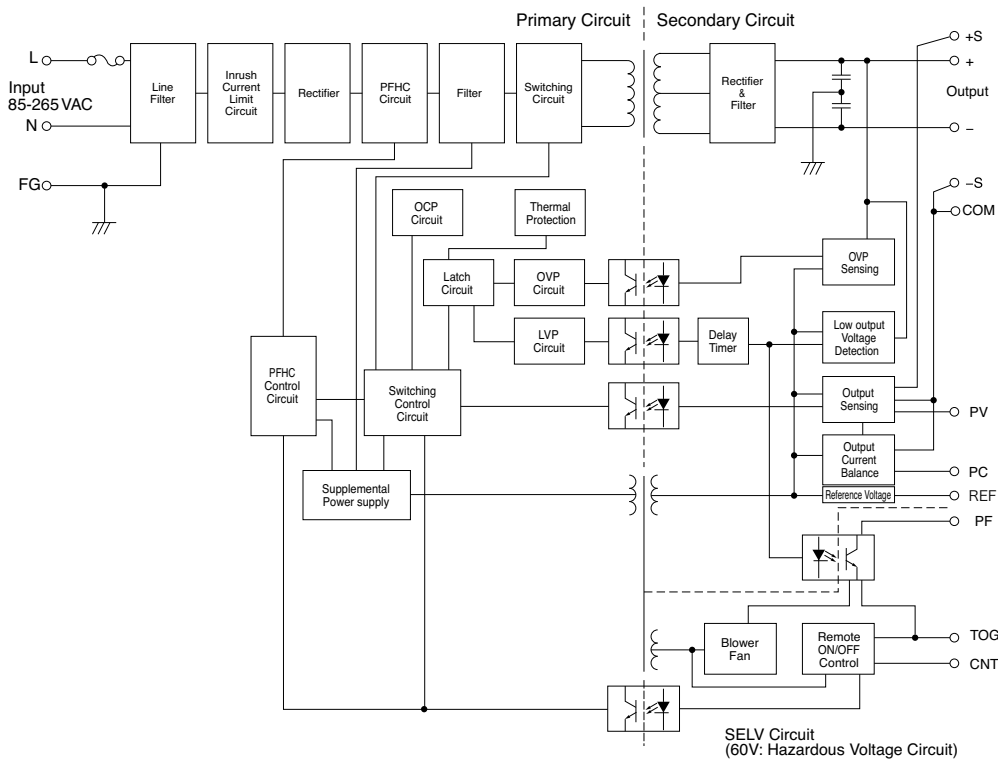

- SWITCHING CIRCUIT
 HALF-BRIDGE CONVERTER 46kHz (fixed)
- PFHC CIRCUIT ACTIVE FILTER 63kHz (fixed)
- FUSE RATING 20A
- FG FUNCTION GROUND

Block Diagram

[HWS1500]

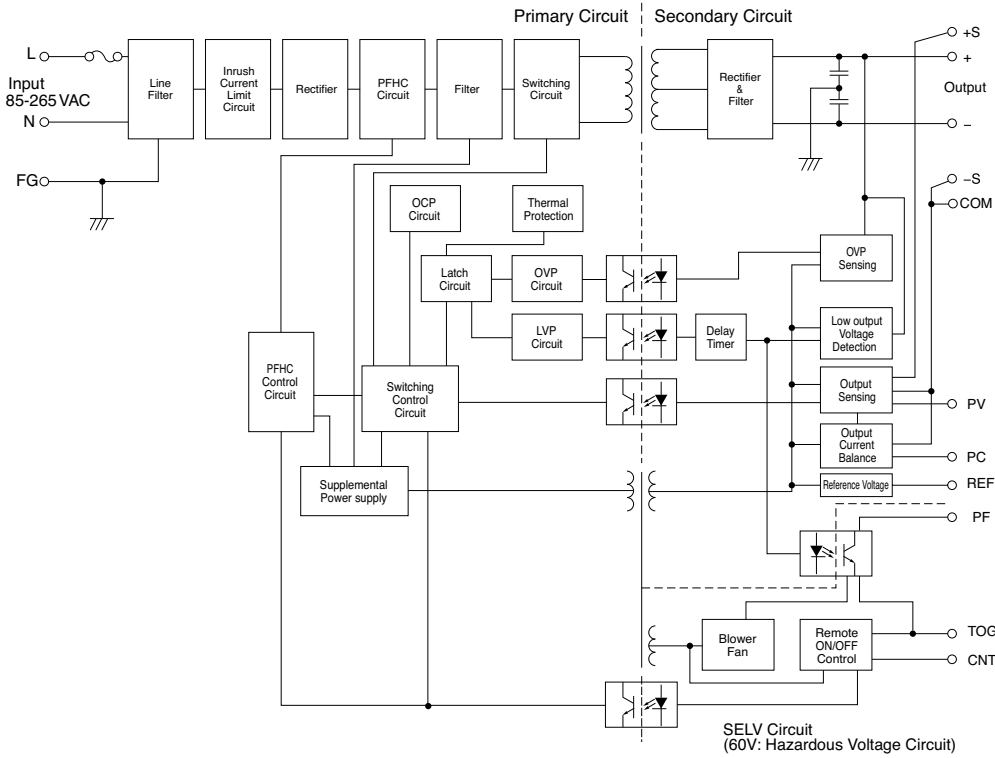

- Switching circuit
Half - bridge converter : 3 - 5V 45kHz (fixed), 6 - 7V 55kHz (fixed), 12 - 60V 70kHz (fixed)
- PFHC circuit : Active filter 65kHz (fixed)
- Fuse rating : 30A
- FG : Function ground

[HWS1800T]

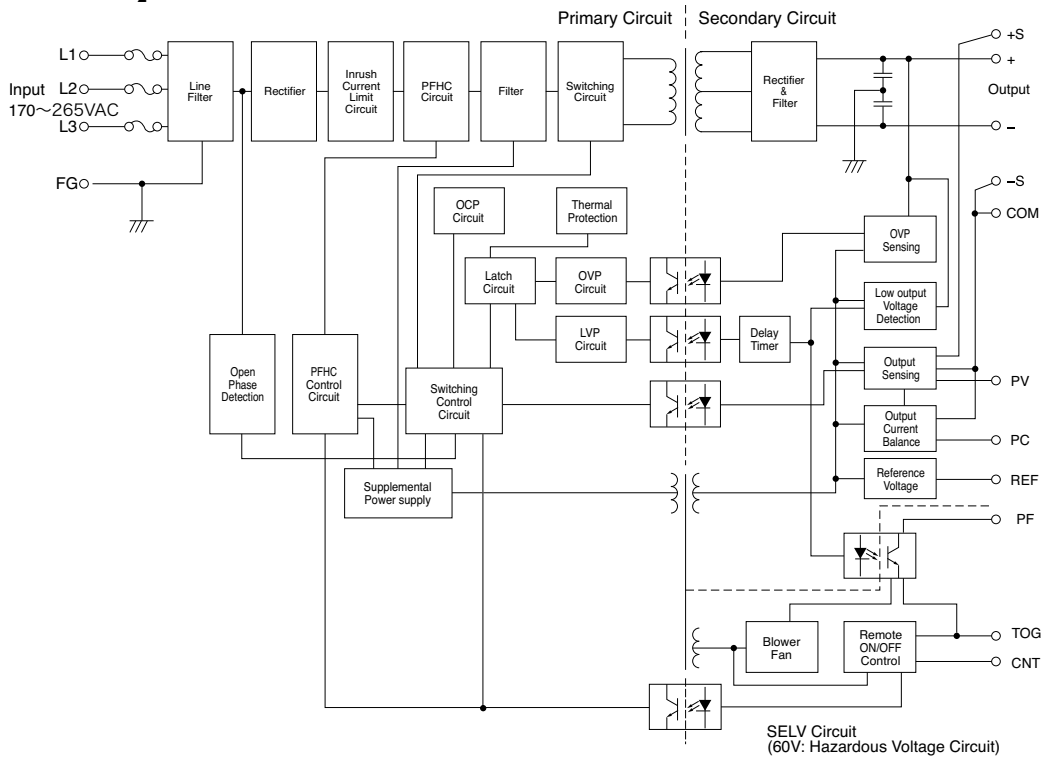

- Switching circuit
Half - bridge converter : 3 - 5V 45kHz (fixed), 6 - 7V 55kHz (fixed), 12 - 60V 70kHz (fixed)
- PFHC circuit : Active filter 65kHz (fixed)
- Fuse rating : 20A
- FG : FUNCTION GROUND

HWS

HWS HD

HWS ME

HWS-P

Instruction Manual

Sequence Time Chart

[HWS300, HWS600]

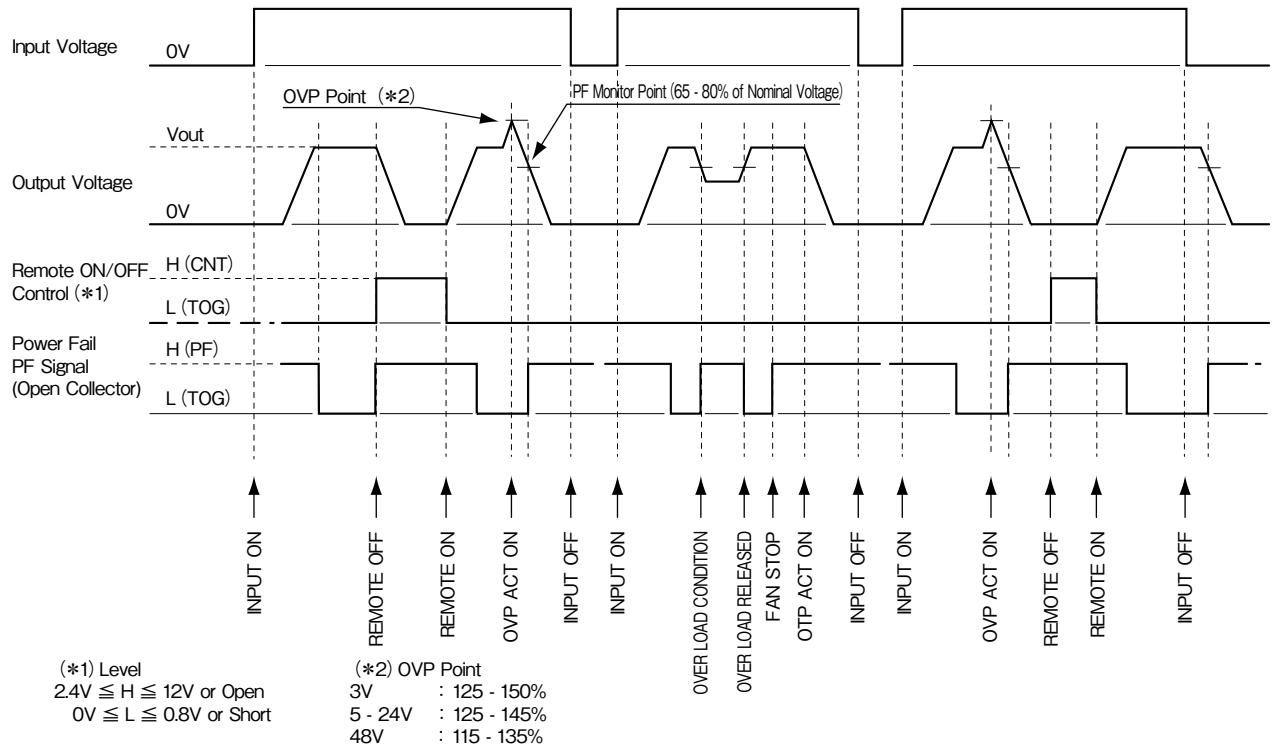

[HWS1000]

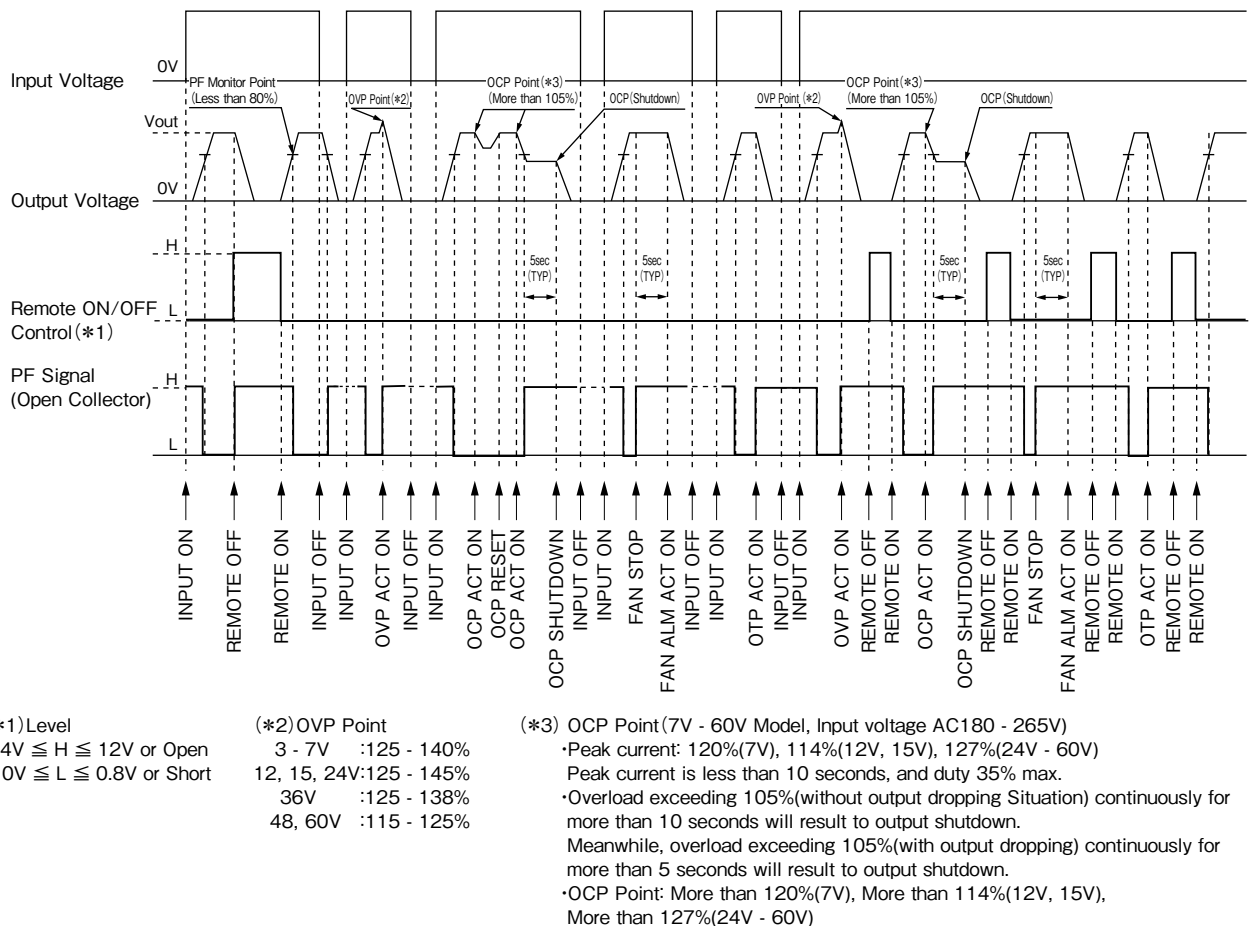

Sequence Time Chart

[HWS1500]

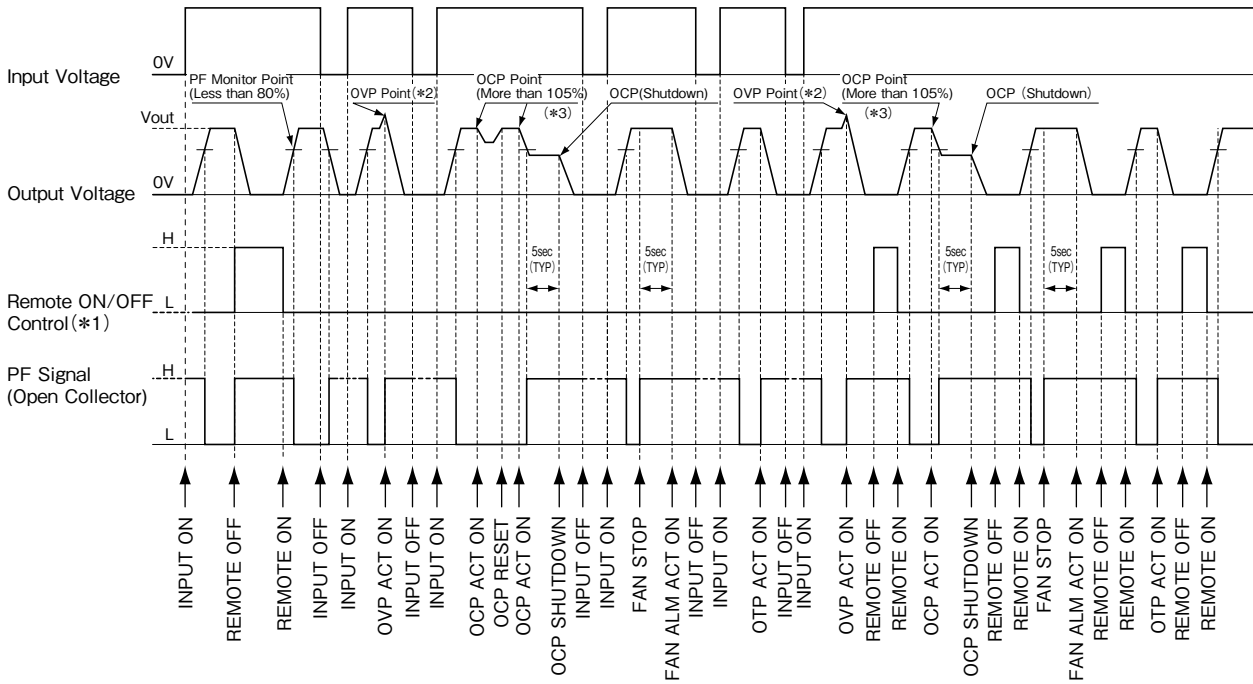

(*1) Level
 2.4V ≤ H ≤ 12V or Open
 0V ≤ L ≤ 0.8V or Short

(*2) OVP Point
 3 - 7V : 125 - 140%
 12, 15, 24V : 125 - 145%
 36V : 125 - 138%
 48V : 115 - 135%
 60V : 115 - 125%

(*3) OCP Point (6V 7V, 24V, 36V, 60V Model, Input voltage AC180 - 265V)
 •Peak current: 120%(6V 7V), 150%(24V, 36V, 60V)
 Peak current is less than 10 seconds, and duty 35% max.
 •Overload exceeding 105%(without output dropping situation) continuously for more than 10 seconds will result to output shutdown.
 •Meanwhile, overload exceeding 105%(with output dropping) continuously for more than 5 seconds will result to output shutdown.
 •OCP Point: More than 120%(6V 7V), More than 150%(24V, 36V, 60V)

[HWS1800T]

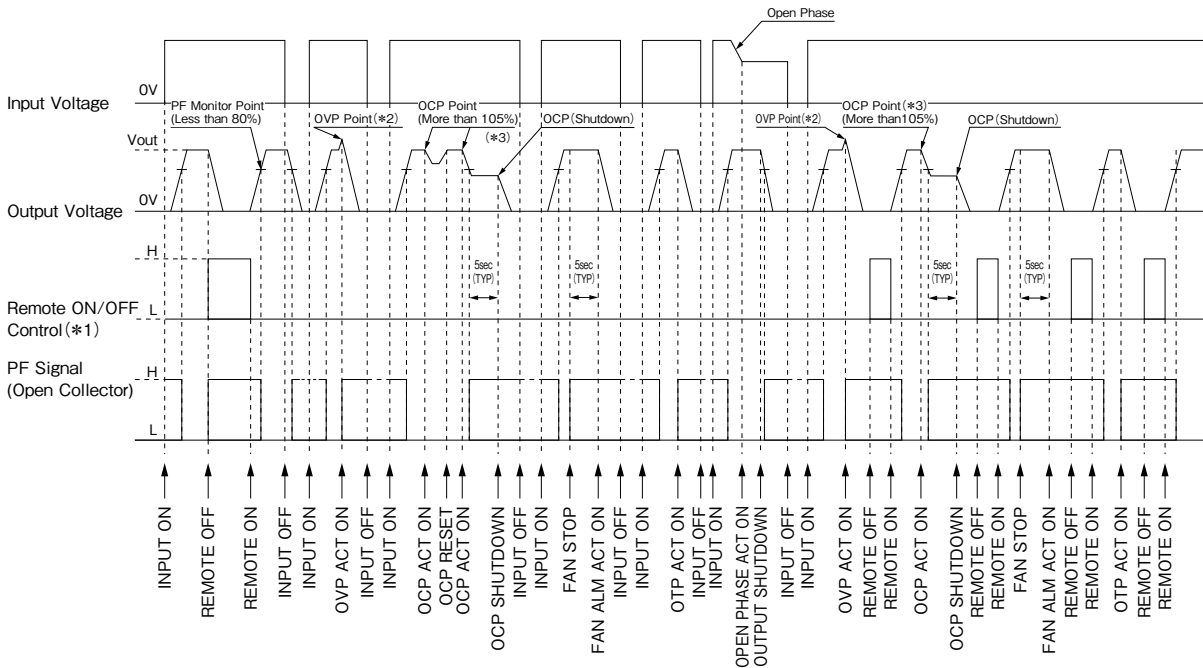

(*1) Level
 2.4V ≤ H ≤ 12V or Open
 0V ≤ L ≤ 0.8V or Short

(*2) OVP Point
 3 - 7V : 125 - 140%
 12, 15, 24V : 125 - 145%
 36V : 125 - 138%
 48, 60V : 115 - 125%

(*3) OCP Point
 •Peak current: 120%(6V - 15V), 140%(24V - 60V)
 Peak current is less than 10 seconds, and duty 35% max.
 •Overload exceeding 105%(without output dropping situation) continuously for more than 10 seconds will result to output shutdown.
 Meanwhile, overload exceeding 105%(with output dropping) continuously for more than 5 seconds will result to output shutdown.
 •OCP Point: More than 120%(6V - 15V), More than 140%(24V - 60V)

HWS 15 -150 Series Instruction Manual

BEFORE USING THE POWER SUPPLY UNIT

Pay attention to all warnings and cautions before using the unit. Incorrect usage could lead to an electric shock, damage to the unit or a fire hazard.

⚠ WARNING and CAUTION

- Do not modify.
- Do not touch the internal components, they may have high voltage or high temperature. You may get electric shock or burned.
- When the unit is operating, keep your hands and face away from it, you may get injured by an accident.
- This power supply is primarily designed and manufactured to be used and enclosed in other equipment. Stick the WARNING label for users on the system equipment and describe the notice in the instruction manual.
- Never operate the unit under over current or shorted conditions for long time, which could result in damage or insulation failure. There is no possibility for fire or burning.
- Confirm connections to input/output terminals are correct as indicated in the instruction manual.
- Do not use the product in the environment with strong electromagnetic field, corrosive gas and conductive substance.

Note : CE MARKING

CE Marking, when applied to a product covered by this handbook, indicates compliance with the low voltage directive (73/23/EEC) as modified by the CE Marking Directive (93/68/EEC) which complies with EN60950

Notes for HWS30-150/ME IEC/EN/UL60601-1

⚠ Notes

- The product should be completely enclosed in the application according to the specifications, and contact to the I/O part with the patient be limited. Be careful when designing the out-line. Please refer to section 16, IEC/EN/UL60601-1.
- This product is not suitable for the use of the combustible narcotic that oxygen or the nitrous oxide mixed.
- It is necessary to fuse it in two poles of the main power supply in the overall equipment into which this product is built excluding the permanent installation type equipment defined by IEC/EN/UL60601-1 section 57.6. The fuse is installed in the monopole of the input of this product (live line).
- Between I/O of this product is evaluated as the basic insulation by IEC/EN/UL60601-1. Please add further insulation for safe contact to the output part.
- Please refer to local regulations for the disposal of the product that passes the life.
- The leakage current of this product in normal condition is 500uA or less. (At input voltage 230VAC.) The unit is suitable for medical equipment as provided by IEC/EN/UL60601-1. In the application according to the UL60601 requirement, it is assumed that surfaces of all equipment is assembled with the insulating materials.
- This product is not evaluated by IEC/EN/UL60601-1-2(EMC). However, EMC test data is available at TDK-Lambda.

1. Terminal Explanation

1 HWS15, HWS30, HWS50

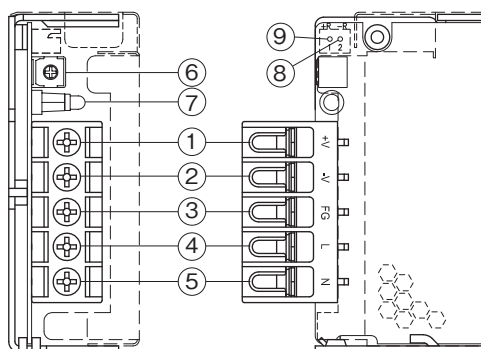

- ① + V : + Output terminal
(Standard type: 10A max./terminal)
- ② - V : - Output terminal
(Standard type: 10A max./terminal)
- ③ FG: Frame Ground
- ④ L : Input terminal Live line (Fuse in line)
- ⑤ N : Input terminal Neutral line
- ⑥ Output voltage adjustment trimmer
- ⑦ Output monitoring indicator (Green LED)

HWS50/R * (Option)

- ⑧ - R : Remote ON/OFF control (HWS50: Option)
- ⑨ + R : Remote ON/OFF control (HWS50: Option)

Connector (JST) for Remote ON/OFF control

Connector	Housing	Terminal Pin
B2B-XH-AM (LF)	XHP-2	BXH-001T-P0.6 or SXH-001T-P0.6

2 HWS80, HWS100, HWS150

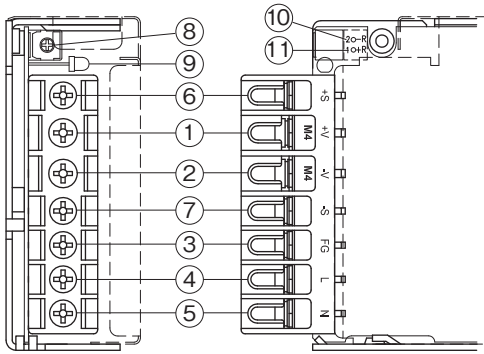

- ① + V: +Output terminal
(30A max./terminal, M4 screw)
- ② - V: -Output terminal
(30A max./terminal, M4 screw)
- ③ FG: Frame Ground
- ④ L: Input terminal Live line (Fuse in line)
- ⑤ N: Input terminal Neutral line
- ⑥ + S: +Remote sensing terminal
- ⑦ - S: -Remote sensing terminal
- ⑧ Output voltage adjustment trimmer
- ⑨ Output monitoring indicator (Green LED)

HWS80/R*, HWS100/R*, HWS150/R* (Option)

- ⑩ - R: Remote ON/OFF control (Option)
- ⑪ + R: Remote ON/OFF control (Option)

* Connector (JST) for Remote ON/OFF control

Connector	Housing	Terminal Pin
B2B-XH-AM (LF)	XHP-2	BXH-001T-P0.6 or SXH-001T-P0.6

2. Terminal connecting method

- Input must be off when making connection.
- Connect FG terminal to ground terminal of the equipment.
- The output load line and input line shall be separated and twisted to improve noise sensitivity.
- Remote sensing lines shall be twisted or use shielded wire.
- Remote ON/OFF control lines shall be twisted or use shielded wire.
- Use the output connector specified in outline drawing. Also, use recommended crimping tool.

HWS15, HWS30, HWS50

HWS80, HWS100, HWS150

Basic connection (Local sensing)

Connect "+S" terminal to "+V" terminal, and "-S" terminal to "-V" terminal with the attached short pieces.

Remote sensing connection

Connect "+S" terminal to "+V" terminal of load, and "-S" terminal to "-V" output terminal of load with wires. When remote sensing terminals are opened, output is shut down.

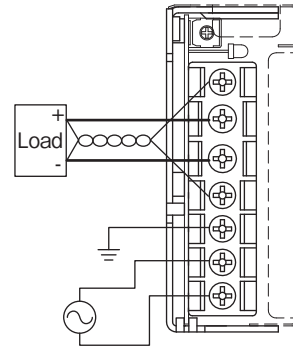
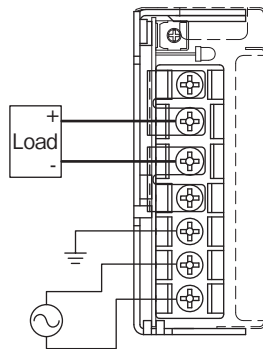
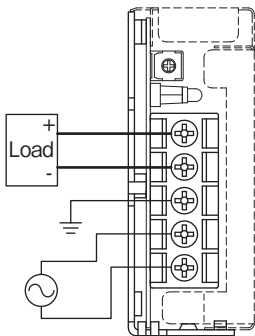

3. Explanation of Functions and Precautions

1 Input Voltage Range

Input voltage range is single phase 85-265VAC (47-63Hz) or 120-370VDC. Input voltage which is out of specification may cause unit damage. For cases where conformance to various safety specs (UL, CSA, EN) are required, to be described as 100-240VAC (50/60Hz).

within +/- 20% (3.3V: +20% /-10% , 48V: +10%/-20%) of nominal output voltage. To turn the trimmer clockwise, the output voltage will be increased. Note over voltage protection (OVP) function may trigger if the output voltage is increased excessively.

2 Output Voltage Range

V.ADJ trimmer on the front panel side can adjust the output voltage within the range. Output voltage range is

3 Inrush Current

This series uses Power Thermistor to protect the circuit from Inrush Current. Please carefully select input switch and fuse in cases of the high temperature and the power re-input.

4 Over Voltage Protection (OVP)

The OVP function (inverter shut down method, manual reset type) is provided. When OVP triggers, the output will be shut down. The input shall be removed for a few minutes, and then re-input for recovery of the output. OVP setting shall be fixed and not to be adjusted externally. Never apply more than rated output voltage to output terminal, which may lead damage. In the case of inductive load, use decoupling diode at output line.

5 Over Current Protection (OCP)

Constant current limiting and Hiccup (except HWS15, HWS30, which characterized fold back), automatic recovery. OCP function operates when the output current exceeds 105% of maximum output current on specification. The output will automatically recovered when the overload condition is canceled. Never operate the unit under over current or shorted conditions for more than 30 seconds, which could result in damage.

6 Remote Sensing (+S, -S terminal) (For HWS80, HWS100, HWS150)

This function compensates voltage drop of wiring from output terminals to load terminals. Connect "+S" terminal to "+V" terminal of load and "-S" terminal to "-V" terminal of load with sensing wires. The total line voltage drop (+ side line and - side line) shall be less than 0.3V. In case that sensing line is too long, it is necessary to put an electrolytic capacitor in following 3 places;

- 1) Across the load terminal,
- 2) Between "+S" terminal and "+V" terminal,
- 3) Between "-S" terminal and "-V" terminal.

If remote sensing terminals are opened, the output will rise and OVP may be triggered.

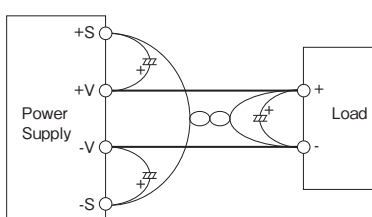

7 Output Ripple & Noise

The standard specification for maximum ripple value is measured according to measurement circuit specified by JEITA RC-9131A. When load lines are longer, ripple will become larger. In this case, electrolytic capacitor, film capacitor, etc. might be necessary to use across the load terminal. The output ripple cannot be measure accurately if the probe ground lead of oscilloscope is too long.

For start up at low ambient temperature and low voltage, output ripple noise of HWS15, HWS30 might not meet specification. However, there is no overshoot at start up and output ripple noise specification can be met after one second.

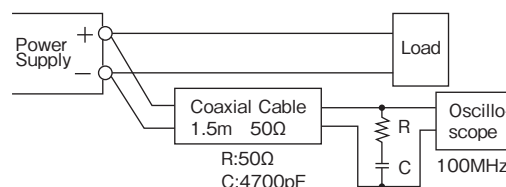

8 Series Operation

For series operation, either method (A) or (B) is possible.

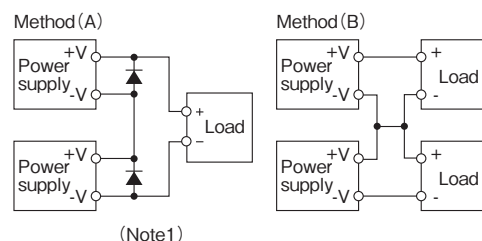

(Note1)

Note : In case of (A), please connect diodes to prevent the reverse voltage.

9 Parallel Operation

- (A) Operation to increase the Output Current is not possible.
- (B) Operation as a Backup Power Supply is possible as follows.
 1. Set the power supply output voltage higher by the amount of forward voltage drop (VF) of the diode.
 2. Please adjust the output voltage of each power supply to be the same.
 3. Please use within the specifications for output voltage and output current.

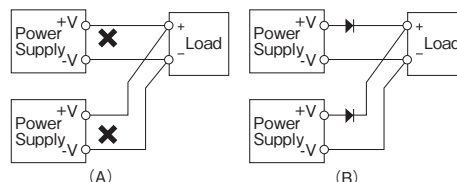

10 Remote ON/OFF Control (HWS50 - 150 Optional Spec.)

Remote ON/OFF control function is available as option with model name followed by /R. Using this function allows the user to turn the output on and off without having to turn the AC input on and off. It is controlled by the voltage applied to +R and -R. This circuit is in the Secondary (output) side of the power supply unit. Do not connect in the Primary (input) side. And this circuit is isolated from the output by a photocoupler.

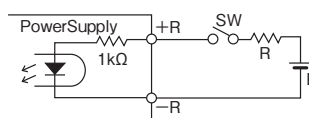

The control mode is shown below.

+ R & - R terminal condition	output condition	External voltage level: E	External resistance: R
SWON (Higher than 4.5V)	ON	4.5 ~ 12.5VDC	No required
SWOFF (Lower than 0.8V)	OFF	12.5 ~ 24.5VDC	1.5kΩ

11 Isolation Test

Isolation resistance between output and FG shall be more than 100MΩ at 500VDC. For safety, voltage setting of DC isolation tester must be done before the test. Ensure that it is fully discharged after the test.

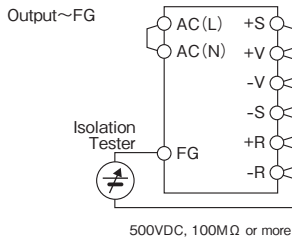

testing withstand voltage, set current limit of withstand voltage test equipment at 20mA (Output-FG : 100mA). The applied voltage must be gradually increased from zero to testing value and then gradually decreased for shut down. When timer is used, the power supply may be damaged by high impulse voltage at timer switch on and off. Connect input and output as follows.

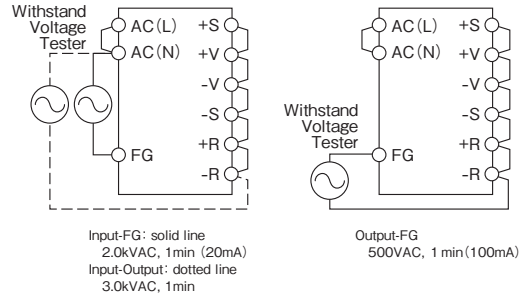

12 Withstand Voltage

This series is designed to withstand 3.0kVAC between input and output, 2.0kVAC between input and FG and 500VAC between output and FG each for 1 minute. When

4. Mounting Directions

1 Output Derating according to the Mounting Directions

Recommended standard mounting is method (A). Method (B), (C) and (D) are also possible. Refer to the derating below. Please do not use installation method (E), where the PCB will be on the topside and heat will be trapped inside the unit. In the following derating curve, the maximum output current is considered to be 100% .

Standard Mounting (A)

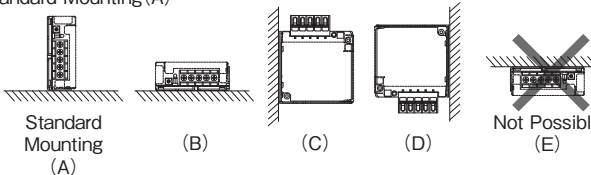

Output Derating
(A) Standard Mounting Direction (Open frame)

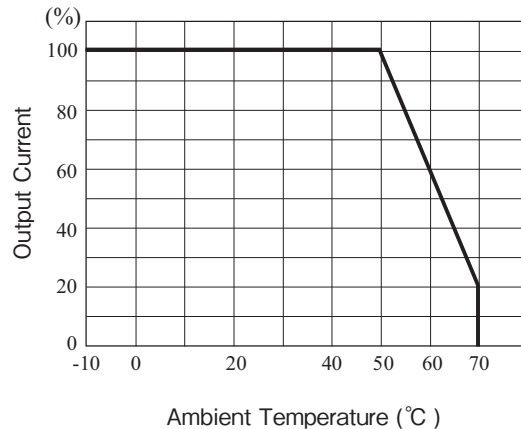

Open Frame (Without Cover)

Model	HWS15				HWS30				HWS50				HWS80, HWS100				HWS150				
	A	B	C	D	A	B	C	D	A	B	C	D	A	B	C	D	A	B	C	D	
Amb. Temp.	-10 to +30°C	100	100	100	100	100	100	100	100	100	100	100	100	100	100	100	100	100	100	100	100
40°C	100	100	100	100	100	100	100	100	100	100	100	100	100	100	100	100	100	100	90	90	
50°C	100	100	100	100	100	100	100	100	100	100	60	60	100	80	80	80	100	80	80	80	
60°C	60	60	60	60	60	60	60	60	60	60	20	20	60	60	60	60	60	60	60	60	
70°C	20	20	20	20	20	20	20	20	20	20	-	-	20	20	20	20	20	20	20	20	

With Cover (/RA Option)

Model	HWS15				HWS30				HWS50				HWS80, HWS100				Model	HWS150				
	A	B	C	D	A	B	C	D	A	B	C	D	A	B	C	D		Amb. Temp.	A	B	C	D
Amb. Temp.	-10 to +30°C	100	100	100	100	100	100	100	100	100	100	100	100	100	100	100	100	-10 to +25°C	100	100	100	100
40°C	100	100	100	100	100	100	100	100	100	100	60	60	100	80	80	80	40°C	100	76	76	76	
50°C	60	60	60	60	60	60	60	60	60	60	20	20	60	60	60	60	50°C	60	60	60	60	
60°C	20	20	20	20	20	20	20	20	20	20	-	-	20	20	20	20	60°C	20	20	20	20	

2 Mounting Method

(1) This is convection cooling type power supply. In the consideration for the heat radiation and safety. Please take a distance more than 15mm between the power supply and the peripheral parts. When lining up multiple units, please make sure to place them 15mm or more apart from each other.

Be sure to insert the insulating spacer (MIN 5mm) on the component side of without-cover models.

(2) The maximum allowable penetration of mounting screws is 6mm.

(3) Recommended torque for mounting screw
 HWS15-150 (M3 screw) : 0.49N·m (5.0kgf·cm)

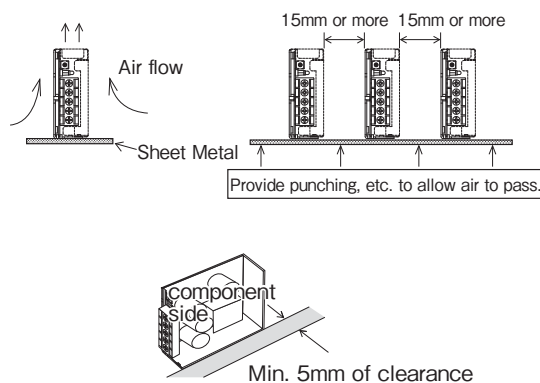

5. Wiring Method

- The output load line and input line shall be separated and twisted to improve noise sensitivity.
- The sensing lines shall be twisted and separated from the output lines.
- Use all lines as thick and short as possible to make lower impedance.
- Noise can be eliminated by attaching a capacitor to the load terminals.

- In HWS15-50, the output current of each output terminal is limited to 10A.
- In HWS80-150, the output current of each output terminal is limited to 30A.
- For safety and EMI considerations, connect the FG terminal of HWS15-150 to mounting set ground terminal.
- The recommended wire type :

MODEL	Recommended wire	Recommended torque	Recommended crimp-type terminal		
			D (MAX)	t (MAX)	Mounting piece (MAX)
HWS15 - 50	AWG14-22	M3.5 Screws 1.0N·m (9.8kgf·cm) - 1.4N·m (13.7kgf·cm)	6.8mm	0.8mm	2 pieces
HWS80,100	AWG12-22	M4 Screws 1.2N·m (11.8kgf·cm) - 1.6N·m (15.6kgf·cm)	8.1mm	1.0mm	1 piece
	AWG14-22			0.8mm	2 pieces
HWS150	AWG10-22	M4 Screws 1.2N·m (11.8kgf·cm) - 1.6N·m (15.6kgf·cm)	8.1mm	1.0mm	1 piece
	AWG10-22			0.8mm	2 pieces
	AWG14-22	M3.5 Screws 1.0N·m (9.8kgf·cm) - 1.4N·m (13.7kgf·cm)	6.8mm	0.8mm	2 pieces

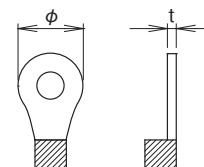

Note 1 : When using separate loads, use of two pcs. of 0.8mm thick crimp-type terminal is recommended.
 Note 2 : For recommended diameter, refer to wire maker recommended allowable current and voltage drop.
 Especially, for 3V or 5V models, output current is large. Thick diameter wire is recommended.

6. External Fuse Rating

Refer to the following fuse rating when selecting the external fuses that are to be used on input line. Surge current flows when line turns on. Use slow-blow fuse or time-lug fuse. Do not use fast-blow fuse. Fuse rating is specified by in-rush current value at line turn-on. Do not select the fuse

according to input current (rms.) values under the actual load condition.

HWS15, HWS50: 2A HWS30, HWS80, HWS100: 3.15A
 HWS150: 5A

7. Before concluding that the unit is at fault...

Before concluding that the unit is at fault, make the following checks.

- Check if the rated input voltage is connected.
- Check if the wiring of input and output is correct.
- Check if the wire size is not too thin.
- Check if the output voltage control (V.ADJ) is properly adjusted.
- Check if the Remote ON/OFF control connector is not opened, when use Remote ON/OFF control function.
- Check if the output current and output wattage dose not exceed specification.
- Audible noise can be heard during Dynamic-Load operation.
- Audible noise can be heard when input voltage waveform is not sinusoidal wave.
- Ensure that a large capacitor is not connected on the output side. Please use within maximum capacitance shown below.

MODEL	Maximum external capacitance					
	3.3V	5V	12V	15V	24V	48V
HWS15	10,000uF		5,000uF	2,000uF	1,000uF	500uF
HWS30, HWS50	10,000uF		5,000uF		2,000uF	500uF
HWS80, HWS100, HWS150	10,000uF				5,000uF	1,000uF

8. Range of free warranty

Conditions of usage at the free of charge warranty are as follows.

- Average operating temperature (ambient temperature of the power supply unit) is under 40°C.
 - Average load factor is 80% or less.
 - Installation method : Standard installation.
- However, the maximum rating is within the output derating.

Following cases are not covered by warranty.

- Improper usage like dropping products, applying shock and defects from operation exceeding specification of the units.
- Defects resulting from natural disaster (fire, flood).
- Unauthorized modifications or repair by the buyers defects not cause by TDK-Lambda.

HWS300, 600 Series Instruction Manual

BEFORE USING THE POWER SUPPLY UNIT

Be sure to read the following precautions thoroughly before using this power supply unit.

Pay attention to all warnings and cautions before using the unit. Incorrect usage could lead to an electric shock, damage or a fire hazard.

WARNING

- Do not make unauthorized changes to power supply unit, otherwise you may have electric shock and void warranty.
- Do not touch the internal components, they may have high voltage or high temperature. You may get electric shock or burned.
- When the unit is operating, keep your hands and face away from it; an accident may injure you.
- Do not use unit under unusual condition such as emission of smoke or abnormal smell and sound etc. It might cause fire and electric shock.
In such case, please contact us; do not repair by yourself, as it is dangerous for the user.
- Do not drop or insert anything into unit. It might cause failure and fire, when using the unit under such condition.
- Do not operate these units at the condition of condensation. It may cause fire and electric shock.
- The outputs of these products must be earthed in the end use equipment to maintain SELV.
If the outputs are not earthed, they must be considered hazardous and must not be made user accessible.

CAUTION

- This power supply is primarily designed and manufactured to use and enclose in other equipment.
- This power supply unit has a built-in fan for air-cooling. Do not block air intake and exhaust. It might cause fire.
- Input voltage, output current, output power, ambient temperature and ambient humidity should be within specifications, otherwise the unit will be damaged.
- The unit might be broken down by accident or unexpected situation. For application equipment, which requires very high reliability (nuclear related equipment, traffic control equipment, medical equipment, etc.), please provide fail safety function in the equipment.

- Do not make an improper wiring to input and output terminals. It may cause damage.
- Do not use in environment such as strong electromagnetic field, erosive gas etc, or any environment where conductive foreign substance may enter.
- Do not operate and store this unit at the condition of condensation. In such case, waterproof treatment is necessary.
- Do not operate this unit after it falls down.
- The output voltage of this power supply is considered to be a hazardous energy level, and must not be accessible to an operator.

Notes for HWS30-150/ME IEC/EN/UL60601-1

NOTES

- The product should be completely enclosed in the application according to the specifications, and contact to the I/O part with the patient be limited. Be careful when designing the outline. Please refer to section 16, IEC/EN/UL60601-1.
- This product is not suitable for the use of the combustible narcotic that oxygen or the nitrous oxide mixed.
- The signal port connects only the device that suits IEC/EN/UL60601-1.
- It is necessary to fuse it in two poles of the main power supply in the overall equipment into which this product is built excluding the permanent installation type equipment defined by IEC/EN/UL60601-1 section 57.6. The fuse is installed in the monopole of the input of this product (live line).
- Between I/O of this product is evaluated as the basic insulation by IEC/EN/UL60601-1. Please add further insulation for safe contact to the output part.
- Please refer to local regulations for the disposal of the product that passes the life.
- The leakage current of this product in normal condition is 500uA or less. (At input voltage 230VAC.) The unit is suitable for medical equipment as provided by IEC/EN/UL60601-1. In the application according to the UL60601 requirement, it is assumed that surfaces of all equipment is assembled with the insulating materials.
- This product is not evaluated by IEC/EN/UL60601-1-2(EMC). However, EMC test data is available at TDK-Lambda.

1. Terminal Explanation

Please pay extra attention to the wiring. Incorrect connection will damage the power supply.

1 Front Panel Explanation

● HWS300

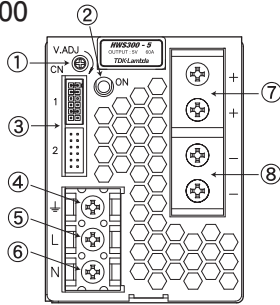

● HWS600

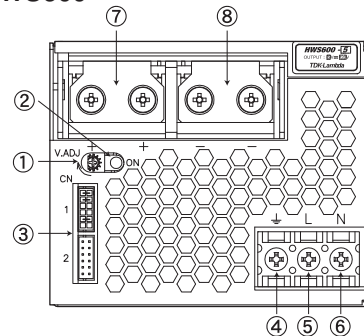

- ① V.ADJ: Output voltage adjustment trimmer.
(The output voltage rises when a trimmer is turned clockwise.)
- ② ON: Output (Power On) indication LED
(The indicator turns on when the power supply output is in normal operating condition.)
- ③ CN1, CN2: Remote sensing, ON/OFF control signal, Current balance signal, Power fail signal, Output voltage external control signal. (Refer to 2-2.)

- ④ ⊥ : Protective Earth (Frame ground), M4 screw.
- ⑤ AC input terminal L: Live Line (Fuse in line), M4 screw.
- ⑥ AC input terminal N: Neutral line, M4 screw.
- ⑦ +: + Output terminal
(HWS300: M4 screw x 2 / HWS600: M5 screw x 2)
- ⑧ -: - Output terminal
(HWS300: M4 screw x 2 / HWS600: M5 screw x 2)

2 CN1, CN2 Connector pin Configuration and Function

CN1 and CN2 are same pin configuration and function. They are connected to each other in this power supply unit. When the pin of CN1 side is shorted, the same function pins of CN2 side are also shorted. Please note that the function cannot be separately set with CN1 and CN2.

Pin No	Configuration	Function
1	+ Vm	+Output monitor terminal. Connected to +Output terminal in this Power supply unit. (+Vm terminal can not supply load current.)
2	+ S	Remote sensing terminal for +output. (For remote sensing function, which compensates for line drop between power supply terminals and load terminals. Connect to +Vm terminal when remote sensing function unnecessary.)
3	- Vm	-Output monitor terminal. Connected to -Output terminal in this Power supply unit. (-Vm terminal can not supply load current.)
4	- S	Remote sensing terminal for -output. (For remote sensing function, which compensates for line drop between power supply terminals and load terminals. Connect to -Vm terminal when remote sensing function unnecessary.)
5	PC	Current balance terminal. (For output current balancing in parallel operation.)
6	COM	GND for PC and PV signals.
7	PV (Optional)	Output voltage external control terminal. (For power supply output voltage control with an external voltage. Standard models don't have this function and indicate NC mark at panel.)
8	NC	No connect
9	CNT	Remote ON/OFF control terminal. (Power supply ON/OFF control with an external signal.)
10	TOG	GND for CNT and PF signals. (Same as Pin No.12)
11	PF	Power fail signal (PF signal) output terminal. (As the output voltage drops, or FAN stops and AC input voltage down, "Power Fail" terminal will output "High".
12	TOG	GND for CNT and PF signals. (Same as Pin No.10)

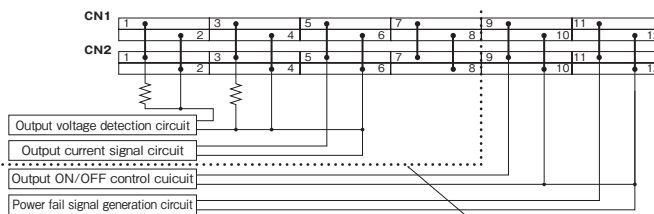
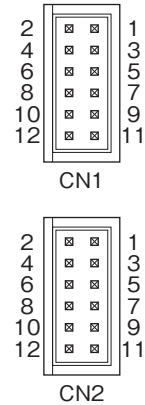

* Output ON/OFF control circuit and the power fail signal circuit are insulated with other circuits in the power supply (insulating voltage AC100V).

CN1, CN2 Connector & Housing & Terminal Pin

PART DESCRIPTION	PART NAME	MANUFACT
PIN HEADER	S12B-PHDSS	JST
SOCKET HOUSING	PHDR-12VS	JST
TERMINAL PINS	SPHD-002T-P0.5 (AWG28-24) SPHD-001T-P0.5 (AWG26-22)	JST
HAND CRIMPING TOOL	YRS-620 (SPHD-002T-P0.5) YC-610R (SPHD-001T-P0.5)	JST

HWS HWS HD HWS ME HWS-P Instruction Manual

2. Terminal Connection Method

Please pay extra attention to the wiring. Incorrect connection will damage the power supply.

- When connecting input and output wiring, and CN1, CN2, input AC-Line should be off.
- Input wiring and output wiring shall be separated to improve noise sensibility.
- The protective earth (PE) must be connected to the \perp terminal or chassis.

- Remote sensing lines shall be twisted or used with shielded wired.
- Remote ON/OFF control lines shall be twisted or used shielded wires. Separate from load line.
- Output current of each terminal screw shall be less than 40A for HWS300. And shall be less than 60A for HWS600.

HWS300 Panel Side (Common HWS600)

Basic connection (Local sensing)

Connect "+S" terminal to "+Vm" terminal and "-S" terminal to "-Vm" terminal. Connect "CNT" terminal to "TOG" terminal with the attached connector.

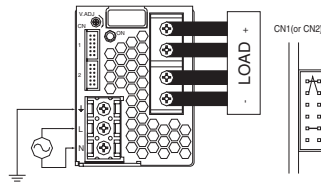

Remote sensing required

Connect "+S" terminal to "+" terminal of load and "-S" terminal to "-" output terminal of load with wires.

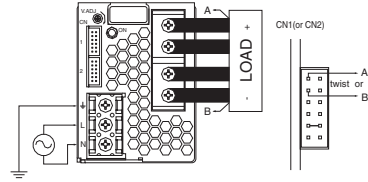

Attached connector when shipping

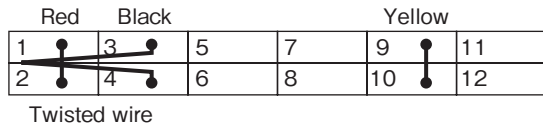

Connecting circuit with CN1 or CN2 connector

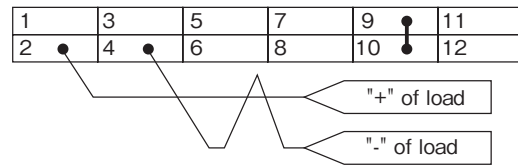

ON/OFF control required

"TOG" terminal is ground for "CNT" terminal.

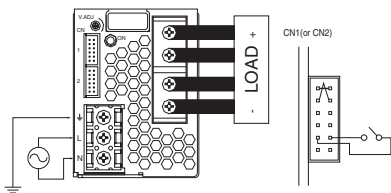

PF signal output required

Open collector method shown below shall be used. "TOG" terminal is ground for "PF" terminal.

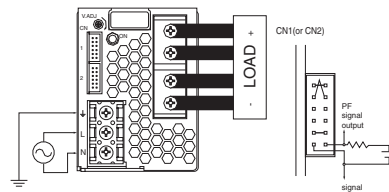

Connecting circuit with CN1 or CN2 connector

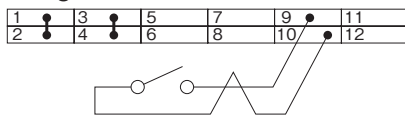

Connecting circuit with CN1 or CN2 connector

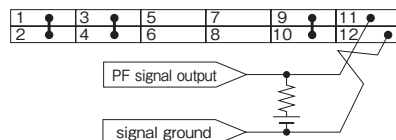

3. Functions and Precautions

1 Input Voltage Range

Input voltage range is single phase 85-265VAC (47-63Hz) or 120-330VDC. Input voltage, which is out of specification, may cause unit damage. Rated input voltage for safety standard application is 100VAC-240VAC (50/60Hz).

2 Output Voltage Range

Output voltage is set to the rated value at shipment. V.ADJ trimmer on the front panel side may be used to adjust the output voltage within the range specified.

Output voltage range is within $\pm 20\%$ of rated output voltage (48V Output Model: -20% to +10%).

To turn the trimmer clockwise, the output voltage will be increased. Take note when the output voltage is increased excessively, over voltage protection (OVP) function may trigger and output voltage will be shut down.

3 Over Voltage Protection (OVP)

The OVP function (inverter shutdown method, manual reset type) is provided. OVP function operates within 125-145% of the rated output voltage value (48V type: 115-135%), and the output will be shut down when OVP function triggers. To reset OVP, remove the input of power supply for a few minutes, and then re-input. Or, use CNT reset (remote ON/OFF: OFF to ON). OVP value is fixed and not to be adjusted externally.

Never apply more than rated output voltage to output terminal, which may lead damage. In the case of inductive load, use decoupling diode at output line.

4 Over Current Protection (OCP)

The OCP function is provided. OCP characteristic is constant current limiting, (less than 5V output model: with Hiccup operation) automatic recovery. OCP function operates when the output current exceeds 105% (24V output model: 119%) of maximum DC output current specification. The output will be automatically recovered when the overload condition is canceled. Never operate the unit under over current or shorted conditions for more than 30 seconds, which may lead damage. OCP setting is fixed and not to be adjusted externally.

5 Over Temperature Protection (OTP)

The OTP function (manual reset type) is provided. When ambient or internal temperature rises abnormally, OTP function operates and output will be shut down. After shut down, remove the input and cool it down to reset OTP.

Then re-input.

6 Low Output Detection Circuit (PF)

Low output voltage detection circuit is provided. Power Fail (PF) signal will turn "High" level to indicate the abnormal status

when the output voltage becomes within 65-80% of rated value caused by either the drop or brownout of the input voltage or OCP, OVP and OTP function operation. When the built-in FAN motor of this power supply unit stops, PF signal will turn to "H". The PF signal is isolated from input and output by a photo-coupler. It uses the open collector method shown below.

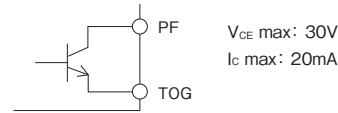

7 Remote Sensing (+S, -S terminal)

This function compensates voltage drop of wiring from output terminals to load terminals. Connect "+S" terminal to "+" terminal of load and "-S" terminal to "-" terminal of load with sensing wires. The total line voltage drop (+ side line and - side line) shall be less than 0.3V. In case that sensing lines are too long, it is necessary to put an electrolytic capacitor in following 3 places;

- 1) across the load terminal,
- 2) between "+S" terminal and "+" terminal,
- 3) between "-S" terminal and "-" terminal.

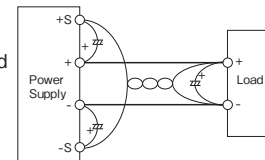

When the function of remote sensing is not used, connect +S terminal to +Vm terminal, and -S terminal to -Vm terminal by the attachment connector.

If remote sensing terminals are opened, the stability and the accuracy of the output deteriorated. Therefore, terminal +S, -S must be connected.

8 Remote ON/OFF Control

Remote ON/OFF control is provided.

Using this function, output on/off is allowed to control without input voltage on/off. The output is turned to ON when TOG and CNT terminals are shorted, and the output is turned to OFF when these terminals are opened. When the function is not used, connect TOG and CNT terminals. The standards for this function are as follows. "TOG" terminal is return for "CNT" terminal.

- (1) TTL compatible. The maximum input voltage to CNT terminal is 12V, and the maximum allowable reverse voltage is -1V. The sink current for CNT terminal is 3.5mA.
- (2) A switch and relay or a transistor can be used as ON/OFF switch.
- (3) Remote ON/OFF control circuit is isolated from the input and output by a photo-coupler and can be controlled regardless of the output potential (+ or -). Connect TOG terminal to ground of control signal.

The mode of control

CNT Level for TOG Terminal	Output	Built-in Fan
Short or L (0V - 0.8V)	ON	Rotate
Open or H (2.4V - 12V)	OFF	Stop

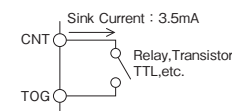

9 Output Ripple & Noise

The standard specification for maximum ripple value is measured specified measurement circuit (JEITA-RC9131A). When load lines are longer, ripple becomes larger. In this case, electrolytic capacitor, film capacitor, etc. might be necessary to use across the load terminal. The output ripple cannot be measured accurately if the probe ground lead of oscilloscope is too long.

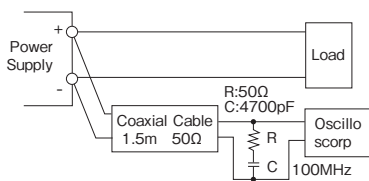

10 Series Operation

For series operation, both method (A) and (B) are possible. There might be a step in the output rise waveform during series operation.

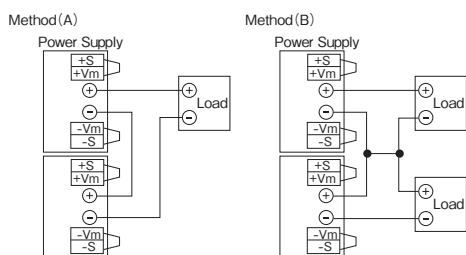

11 Parallel Operation

Current balancing function is provided. Both operations mode (A) and (B) are possible.

- (A) To Increase the Output Current
Correct PC to PC terminal and COM to COM terminal, the current balancing function activates and output current of each power supply is equivalently supplied to load. Wires to PC terminals, COM terminals shall be as short as possible and same length and twisted.
- Adjust the output voltage of each power supply to be same value within 1% or 100mV whichever is smaller.
 - Use same length and type of wires for all load lines.
 - Use the power supply within the rated output current for all paralleled models.
 - Parallel operation is possible up to 5 units.
- (B) To Use as a Backup Power Supply
- Adjust the output voltage of each power supply to be same value.
 - Set power supply output voltage higher by the forward voltage drop of diode.
 - Use within the specifications for output voltage and output current.

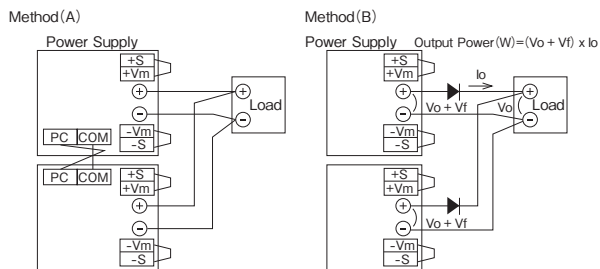

12 Isolation Test

Isolation resistance between output and \perp (chassis) shall be more than 100M Ω at 500VDC and between output and CNT·PF shall be more than 10M Ω at 100VDC. For safety operation, voltage setting of DC isolation tester must be done before the test. Ensure that it is fully discharged after the test.

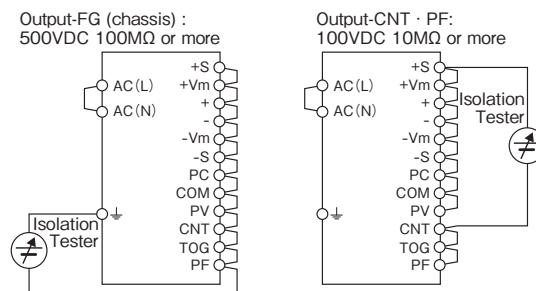

13 Withstand Voltage

This series is designed to withstand 3.0kVAC between input and output, 2.5kVAC between input and \perp (chassis), 500VAC between output and \perp (chassis), and 100VAC between output and CNT·PF terminal each for 1 minute. When testing withstand voltage, set current limit of withstand voltage test equipment at 20mA.

(Output- \perp (chassis) and Output-Control: 100mA).
The applied voltage must be gradually increased from zero to testing value and then gradually decreased for shut down. When timer is used, the power supply may be damaged by high impulse voltage at timer switch on and off. Connect input and output as follows.

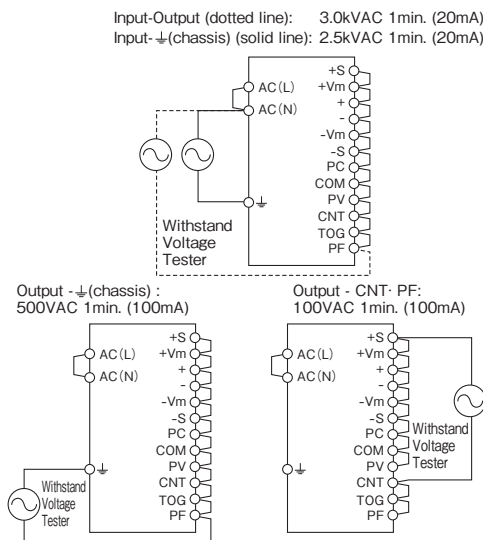

*This product have monolithic ceramic capacitor in secondary circuit to frame ground.
Some of the withstand voltage tester may generate high voltage at the matching with monolithic ceramic capacitor and may cause the unit damage.

So, please check the waveform of test voltage.

14 Output Voltage External Control(PV)

Output voltage external control function is available as option with model name followed by "/PV". Output voltage can be varied by applying an external voltage (1-6V) to "PV" terminal and "COM" terminal. Note if an external voltage is not applied, there will be no output. And if the below connection method is attempted with the standard models internal components could be damaged. Please consider the following characteristics.

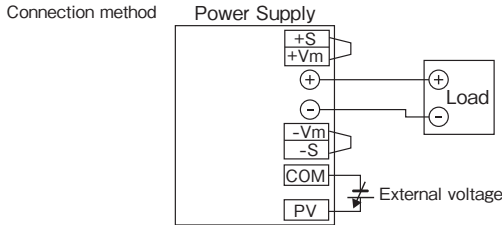

Output Voltage Linearity

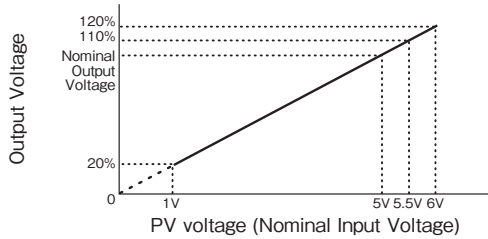

Output Voltage Derating

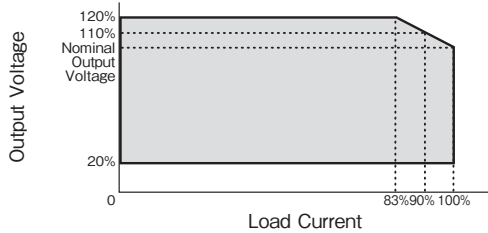

Note 1. Regarding output voltage adjustment below 20%, please consult our sales.

Note 2. For 48V output model only, spaces below must be followed. Limit output voltage variation range at 20% -110% .
At PV voltage variation 1V-5.5V.

15 Output Peak Current

For 24V output model, please meet the following condition. Reduce peak current value according to output derating as section 5-1.

- Input Voltage range: AC180V-265V
- Continuous Peak output time (τ): Within 10 seconds
- Peak output current (I_p): Within the rated peak output current
- Average DC output current (I_m): Within the rated output current

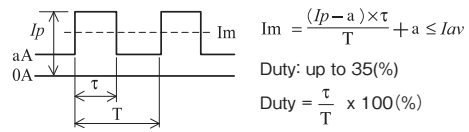

$$I_m = \frac{(I_p - a) \times \tau}{T} + a \leq I_{av}$$

Duty: up to 35(%)
Duty = $\frac{\tau}{T} \times 100(\%)$

I_p : Peak output current(A)
 I_{av} : Rated output current (A)
 I_m : Average output current (A)
 τ : Peak current pulse width (sec)
 T : Period (sec)

4. Mounting Directions

1 Output Derating according to the Mounting Directions

Recommended standard mounting method is (A). Method (B) is also possible. Refer to the derating below.

HWS300

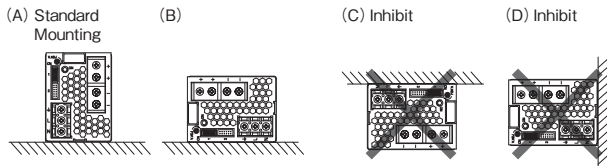

HWS600

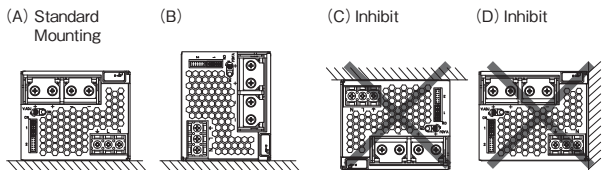

2 Output Derating

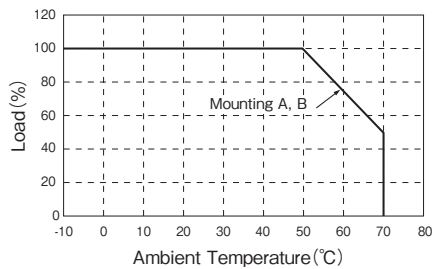

Ta (°C)	Load (%)	
	Mounting (A)	Mounting (B)
-10 to +50	100	
+70	50	

3 Mounting Method

- (1) Forced air cooling type power supply.
This power supply has ventilating holes on the front and back side panels. Keep these two areas freely as much as possible.
- (2) The maximum allowable penetration is 6mm.
Incomplete thread of mounting screw should not be penetrated.
- (3) Recommended torque for mounting screw:
M4 screw: 1.27 N · m (13.0kgf · cm)

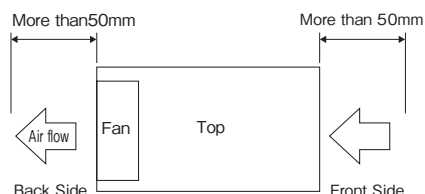

5. Wiring Method

- (1) The output load line and input line shall be separated to improve noise sensitivity.
- (2) The sensing lines shall be twisted and separated from the output lines for remote sensing.
- (3) Use all lines as thick and short as possible to make lower impedance.
- (4) Attaching a capacitor to the load terminals can eliminate noise.
- (5) For safety and EMI considerations, connect ⊥ terminal to the mounting set ground terminal.
- (6) Recommended torque for the terminal;
HWS600 Output terminal (M5 screw): 2.50 N · m (25.5kgf · cm)
HWS300 Input, Output terminal & HWS600 Input terminal (M4 screw): 1.27 N · m (13.0kgf · cm)

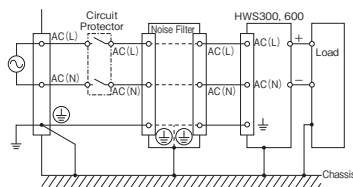

[The PHD connector manufacture method]

This product is using SPHD-001T-P0.5 or SPHD-002T-P0.5 connector made from JAPAN SOLDERLESS TERMINAL MFG CO LTD.

Regarding to manufacture of a connector, it becomes the regulation as following.

a). Applicable Wire and Crimping tool

Wire size is AWG#26-AWG#22 and insulation outer dia is φ 1.0-φ 1.5mm.

Appreciable wire per barrel size is UL1007 (standard wire) and its equivalent standard wire can be used.

Regarding the AWG#22, use UL1061 or its equivalent standard wire, because wire insulation outer diameter of UL1061 is samll. Crimping tool is as below.

Crimping tool	Crimping applicator	Dies
AP-K2 or AP-KS	MKS-LS-10 or MKS-L-10	SPHD-001-05/SPHD-002-05

b). Crimping Operation

The reference value of wire strip is 2.3mm. As wire strip length differs depending on type of wire and crimping method, decide the best wire strip length considering processing condition. When wire is stripped, do not damage or cut off wire conductors.

Table of crimp height

SPHD-001T-P0.5

Wire		Insulation O.D (mm)	Crimp height (mm)	
Type	Size		Conductor part	Insulation part
UL1007	AWG #26	1.3	0.60 - 0.70	1.7
UL1007	AWG #24	1.5	0.65 - 0.75	1.8
UL1061	AWG #22	1.4	0.70 - 0.80	1.8

SPHD-002T-P0.5

Wire		Insulation O.D (mm)	Crimp height (mm)	
Type	Size		Conductor part	Insulation part
UL1007	AWG #28	1.2	0.55 - 0.60	1.6
UL1007	AWG #26	1.3	0.60 - 0.65	1.7
UL1007	AWG #24	1.5	0.62 - 0.67	1.8

Note 1. Crimp height at wire barrel should be set to pre-determined dimensions.

Note 2. Adjust crimp height at wire insulation barrel to the extent that wire insulation is slightly pressed, and set it so that crimping is not excessivery.

Note 3. Crimping condition at wire insulation barrel is as below

Fig.1.
Note 4. For AWG#28, #26, #24, use UL1007 type. For AWG #22, use UL1061 type.

Fig.1



Good

Fig.2: Examples of defective crimping

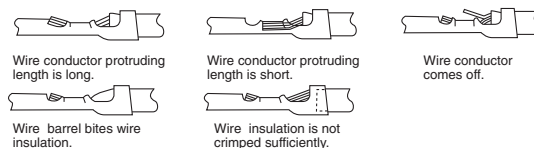

Check of crimping appearance visually for correct crimping as referring to above Fig.2
Check the tensile strength at crimped part when operation finishes.

Table of tensile strength at crimped part.
SPHD-001T-P0.5

Wire size	Requirement N min.	Actual value N
UL1007 AWG#26	20	39.2 - 45.1
UL1007 AWG#24	30	68.6 - 74.5
UL1007 AWG#22	40	92.1 - 96.0

SPHD-002T-P0.5

Wire size	Requirement N min.	Actual value N
UL1007 AWG#28	15	27.0 - 34.3
UL1007 AWG#26	20	44.1 - 48.0
UL1007 AWG#24	30	66.6 - 71.5

c). Inserting contact into housing

Inserting crimped contact into housing

- (1) Do not apply any pulling force to crimped part, and insert contact parallel to housing
- (2) Insert contact into housing without stopping to innermost
- (3) Check secure locking per each insertion by pulling wire softly in order to check that contact does not come off housing. Besides, check whether there is the backlash in the direction of insertion axis.

Defect example of slation insertion

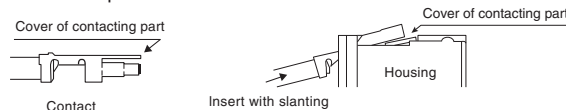

d). Mating and Unmating Connector

(1) Inserting connector

Hold receptacle housing securely and insert into header straight against to header post until click sounds.

(2) Unmating connector

Hold all wires securely and fix receptacle housing by fingers so as to pry, and then, withdraw it on the mating axis.

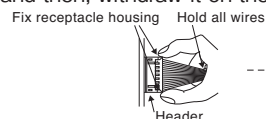

e). Routing of Wire

Routing wire so as not to apply external force to connector except force to such an extent that wire slightly buckles, considering an enough length to route and fixing of wire.

6. External Fuse Rating

Refer to the following fuse rating when selecting the external fuses that are to be used on input line. Surge current flows when line turns on. Use slow-blow or time-lag type fuse, not fast-blow fuse. Fuse rating is specified by in-rush current value at line turn-on. Do not select the fuse according to input cur-

rent (RMS.) values under the actual load condition.

HWS300 : 10A
HWS600 : 15A

7. Fan life expectancy

The Fan-life has limitation. Therefore, periodic maintenance by exchanging the life-expired fan is required for the power supply. The following figure shows the life of fan.

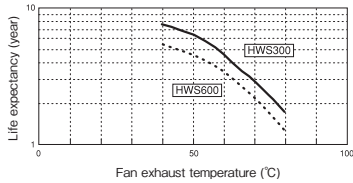

Measurement point of fan exhaust temperature

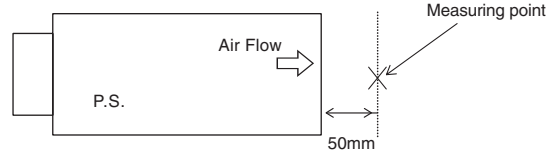

The difference between the intake temperature and the exhaust temperature of the power supply at lo=100% :
HWS300: 4°C
HWS600: 8°C

8. Before concluding that the unit is at fault...

Before concluding that the unit is at fault, make the following checks.

- (1) Check if the rated input voltage is connected.
- (2) Check if the wiring of input and output is correct.
- (3) Check if the I/O terminal connection is properly tighten by regulated torque.
- (4) Check if the wire thickness is enough.
- (5) Check if the output voltage control (V.adj) is properly adjusted. OVP might be trigged and output is shut down.
- (6) If use function of the Remote ON/OFF control, check if the Remote ON/OFF control connector is not opened. If in open condition, power supply will not output.
- (7) Check if the built-in FAN is not stopped. Is FAN stopped by

something irregulars or etc?

If FAN stops, the PF signal turn "High" level and OTP might be activated.

- (8) Power supply has ventilating holes on the front and back panels. Check if there is any irregulars or dust, etc.
- (9) Is the chassis of power supply hot abnormally? The output is shut down by OTP operation. Please re-input after the unit to cool down sufficiently.
- (10) Check if the output current and output wattage does not exceed specification.
- (11) Audible noise can be heard when input voltage waveform is not sinusoidal.
- (12) Audible noise can be heard during dynamic load operation.

9. Range of free warranty

This product is warranted for a period of 5 years from the date of shipment. As for the breakdown under a normal use during free warrantee term, repair is at free of charge. However, the built-in FAN motor replacement is charged. Please contact to our sales office for FAN replacement.

- (3) Installation method : Standard installation. However, the maximum rating is within the output derating.

Conditions of usage at the free of charge warrantee are as follows.

- (1) Average operating temperature (ambient temperature of the power supply unit) is under 40°C
- (2) Average load factor is 80% or less.

Following cases are not covered by warranty.

- (1) Improper usage like dropping products, applying shock and defects from operation exceeding specification of the units.
- (2) Defects resulting from natural disaster (fire, flood).
- (3) Unauthorized modifications or repair by the buyers defects not cause by TDK-Lambda.

10. Option

1 Fan unit for replacement

We have prepared an optional fan unit for replacement.

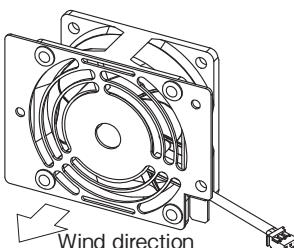
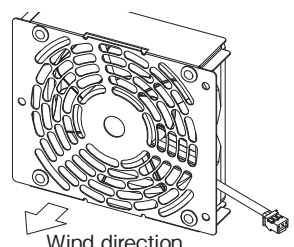
Name of fan unit for replacement	Applicable models	Appearance	Pin assignments	Price								
300-FAN-01	HWS300 (of standard specifications)		Housing = PAP-03-V-S (J.S.T.) Contact = SPHD-001T-P0.5 or PSHD-002T-P0.5 (J.S.T.) <table border="1" data-bbox="933 1624 1204 1736"> <tr><th>Pin No.</th><th>Description</th></tr> <tr><td>1</td><td>Power supply</td></tr> <tr><td>2</td><td>Fan alarm</td></tr> <tr><td>3</td><td>GND</td></tr> </table> Length of fan harness = 55 ± 10mm	Pin No.	Description	1	Power supply	2	Fan alarm	3	GND	Open
Pin No.	Description											
1	Power supply											
2	Fan alarm											
3	GND											
600-FAN-01	HWS600 (of standard specifications)		Housing = PAP-03-V-S (J.S.T.) Contact = SPHD-001T-P0.5 or PSHD-002T-P0.5 (J.S.T.) <table border="1" data-bbox="933 1904 1204 2016"> <tr><th>Pin No.</th><th>Description</th></tr> <tr><td>1</td><td>Power supply</td></tr> <tr><td>2</td><td>Fan alarm</td></tr> <tr><td>3</td><td>GND</td></tr> </table> Length of fan harness = 70 ± 10mm	Pin No.	Description	1	Power supply	2	Fan alarm	3	GND	Open
Pin No.	Description											
1	Power supply											
2	Fan alarm											
3	GND											

Ask us for replacement of the fan. This will be a charged service. If you are replacing the fan by yourself, note the following.

- *1. Be careful in handling the fan unit so as not to cause an impact by dropping it or hitting it, etc.
- *2. Shut down the input before starting the replacement operation.
- *3. Check that there are no loose parts in connectors or harness tucking, etc.
- *4. Safety standards (UL, CE, etc.) are not applicable.

HWS 1000 Series Instruction Manual

BEFORE USING THE POWER SUPPLY UNIT

Be sure to read the following precautions thoroughly before using this power supply unit.

Pay attention to all warnings and cautions before using the unit. Incorrect usage could lead to an electric shock, damage to the unit or a fire hazard.



WARNING

- Do not make unauthorized changes to power supply unit, otherwise you may have electric shock and void your warranty.
- Do not touch the internal components; they may have high voltage or high temperature. You may get electric shock or burned.
- When the unit is operating, keep your hands and face away from it; an accident may injure you.
- Do not use unit under unusual condition such as emission of smoke or abnormal smell and sound etc. It might cause fire and electric shock.
In such case, please contact us; do not repair by yourself, as it is dangerous for the user.
- Do not drop or insert anything into unit. It might cause failure and fire, when using the unit under such condition.
- Do not operate these units at the condition of condensation. It may cause fire and electric shock.
- Power supplies with an output voltage of 48Vdc or less must be earthed in the end use equipment to maintain SELV. If the outputs are not earthed, they must be considered hazardous and must not be made user accessible.
- Power supplies with an output voltage of 60Vdc are considered to be non-SELV. As a result of this, the output must be guarded or a deflector fitted during installation to avoid a SERVICE ENGINEER making inadvertent contact with the output terminals, or dropping a tool onto them. The output of this product must not be connected to a SELV circuit.

Note : CE MARKING

- CE Marking when applied to a product covered by this handbook indicates compliance with the low voltage directive (2006/95/EC) in that it complies with EN60950-1.



CAUTION

- This power supply is primarily designed and manufactured to use and enclose in other equipment.
- This power supply unit has a built-in fan for air-cooling. Do not block air intake and exhaust. It might cause fire.
- Input voltage, output current, output power, ambient temperature and ambient humidity should be used within specifications, otherwise the unit will be damaged.

- The unit might be broken down by accident or unexpected situation. For application equipment, which requires very high reliability (nuclear related equipment, traffic control equipment, medical equipment, etc.), please provide fail safety function in the equipment.
- Do not make an improper wiring to input and output terminals. It may cause damage.
- Do not use in environment such as strong electromagnetic field, erosive gas etc, or any environment where conductive foreign substance may enter.
- Do not operate and store this unit at the condition of condensation. In such case, waterproof treatment is necessary.
- Do not operate this unit after it falls down.
- The output voltage of this power supply unit is considered to be a hazardous energy level (The voltage is 2V or more and the electric power is 240VA or more), prevention from direct contact with voltage output is highly necessary. While installing or servicing this power supply unit, avoid dropping tools by mistake or direct contact with voltage output. This might cause an electrical shock.
While repairing this power supply unit, the AC input power must be switch off and the I/O terminal voltage should be less than the safety level.

CAUTION of IEC/EN/UL60601-1 for HWS1000/ME



CAUTION

- These products are designed for continuous operation within an overall enclosure, and must be mounted such that access to the mains terminals is restricted. See Clause 16, IEC/EN/UL60601-1.
- These products are NOT suitable for use in the presence of flammable anaesthetic mixtures with air or with oxygen or with nitrous oxide.
- Connect only apparatus complying with IEC/EN/UL60601-1 to the signal ports.
- Except for permanently installed equipment as defined in Clause 57.6 of IEC/EN/UL60601-1 the overall equipment in which these products are installed must have double pole fusing on the input mains supply. The products themselves have single pole fusing in the live line.
- These products provide basic insulation only between mains and output, with reference to IEC/EN/UL60601-1. Sure to add supplemental insulation to input or output in the equipment.
- Reference should be made to local regulations concerning the disposal of these products at the end of their useful life.
- The maximum normal leakage current of this product is 500 microamperes for IEC/EN/UL60601-1. When using it as a patient care equipment, all outer surfaces of the equipment shall be constructed of nonconductive material. See Clause 19.5DV.2 of UL60601-1.
- These products have not been assessed to IEC/EN60601-1-2 (EMC) but EMC test data is available from TDK-Lambda.

1. Terminal Explanation

Please pay extra attention to the wiring. Incorrect connection will damage the power supply.

- When connecting input and output wiring, input AC-Line should be off.
- Input wiring and output wiring shall be separated, otherwise noise susceptibility of power supply unit will be weak.

- The protective earth (PE) must be connected to the instrument chassis and the chassis of this power supply unit.
- Remote sensing lines shall be twisted or use the shielded wire.
- Remote ON/OFF control lines shall be twisted or use the shielded wire.

1 Front Panel Explanation

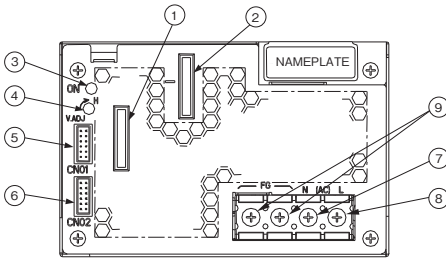

- ① +: + Output terminal
- ② -: - Output terminal
- ③ ON: Output (Power On) indication green LED (The indicator turns on when the power supply output is in normal operating condition.)
- ④ V.ADJ: Output voltage adjust trimmer (The output voltage rises when trimmer is turned clockwise.)
- ⑤ CN01: } Remote sensing, ON/OFF control signal, Current balance signal,
- ⑥ CN02: } Output voltage external control signal and Power fail signal output connector.
- ⑦ N: AC input terminal N : Neutral line
- ⑧ L: AC input terminal L : Live Line (Fuse in line)
- ⑨ FG: Function Ground terminal (Frame ground)

2 CN01, CN02 Connector pin configuration and function

CN01, CN02 pin configuration and function are the same.

They are connected to each other in this power supply unit.

When the pin of CN01 side is shorted the same function pins of CN02 side are shorted.

Please note that the function cannot be separately set with CN01 and CN02.

Pin No.	Configuration	Function
1	+V	Connected to +Output terminal in this power supply unit. (+V terminal can not supply load current.)
2	+S	Remote sensing terminal for +Output (For remote sensing function, which compensates for line drop between power supply terminals and load terminals. Connect to +V terminal when remote sensing function is unnecessary.)
3	-V	Connected to -Output terminal in this power supply unit. (-V terminal can not supply load current.)
4	-S	Remote sensing terminal for -Output (For remote sensing function, which compensates for line drop between power supply terminals and load terminals. Connect to -V terminal when remote sensing function is unnecessary.)
5	PC	Current balance terminal (For output current balancing in parallel operation.)
6	COM	Ground for PC and PV signal.
7	PV	Output voltage external control terminal (For power supply output voltage control with an external voltage. Connect it with the terminal REF when PV function is unnecessary.)
8	REF	Reference voltage terminal for Output voltage control (REF and PV are connected when shipping.)
9	CNT	Remote ON/OFF control terminal (When the CNT is pulled to TTL low, the power supply turns on.)
10	TOG	Ground for CNT and PF signal.
11	PF	Power fail signal output terminal. (As the output voltage drops, FAN stops and AC input voltage down, open collector output, "Power Fail" signal will output "High".)
12	TOG	Ground for CNT and PF signal.

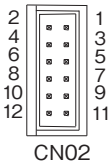
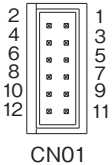

CN01, CN02 are connected in this power supply unit as follows.

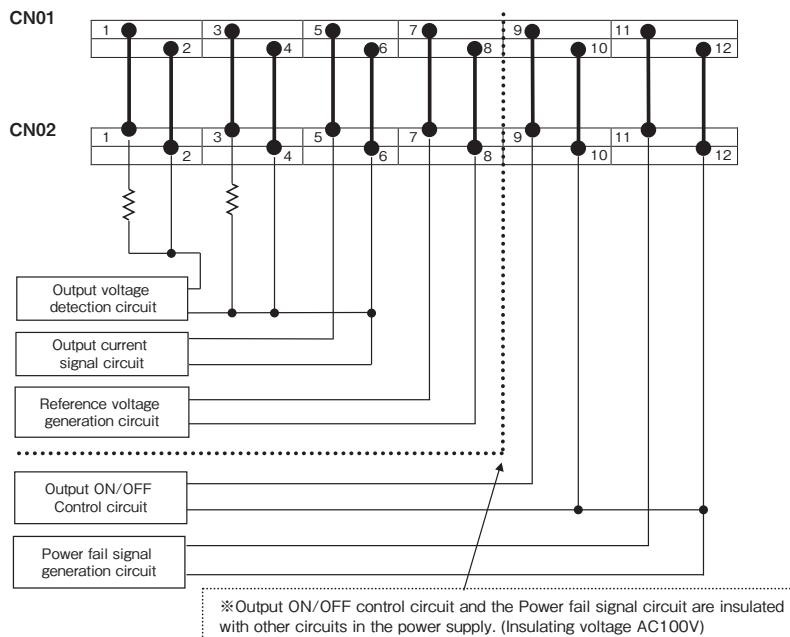

※Output ON/OFF control circuit and the Power fail signal circuit are insulated with other circuits in the power supply. (Insulating voltage AC100V)

3 Basic Connection (Local sensing)

- ① Connect "+S" terminal to "+V" terminal and "-S" terminal to "-V" terminal with sensing wires.
 - ② Connect "CNT" terminal to "TOG" terminal with wire.
 - ③ Connect "PV" terminal to "REF" terminal with wire.
- ※ Please use attachment connector for each connection.
- ※ In the following cases, the output is shut down.
 When CNT and TOG is opened.
 When PV and REF is opened.

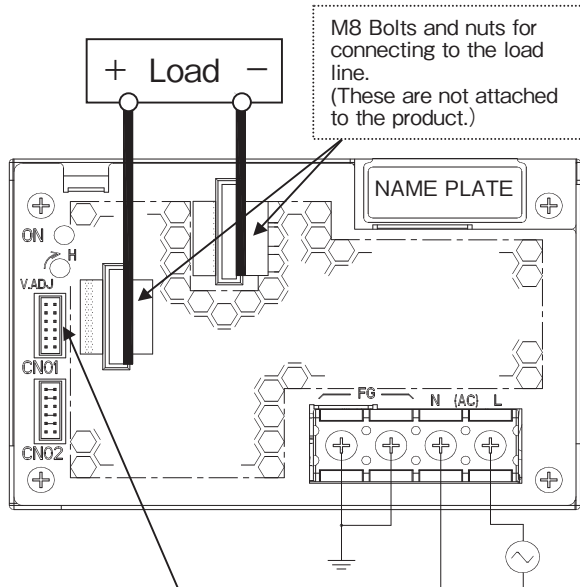

Connector : (JST) S12B-PHDSS

Attached connector when shipping
 • Housing : (JST) PHDR-12VS
 • Contact : (JST) SPHD-001T-P0.5
 1-2, 3-4, 7-8, 9-10 are shorted.

Attached connector when shipping

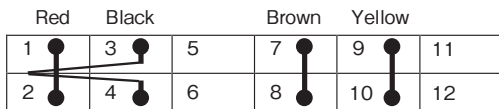

Twist wire

4 Remote sensing required

- ① Connect "+S" terminal to "+" terminal of load with sensing wire.
 - ② Connect "-S" terminal to "-" terminal of load with sensing wires.
 - ③ Connect "CNT" terminal to "TOG" terminal with wire.
 - ④ Connect "PV" terminal to "REF" terminal with wire.
- ※ The accuracy of the output voltage will deteriorate when the sensing terminals are opened.
- ※ In the following cases, the output is shut down.
 When CNT and TOG is opened.
 When PV and REF is opened.

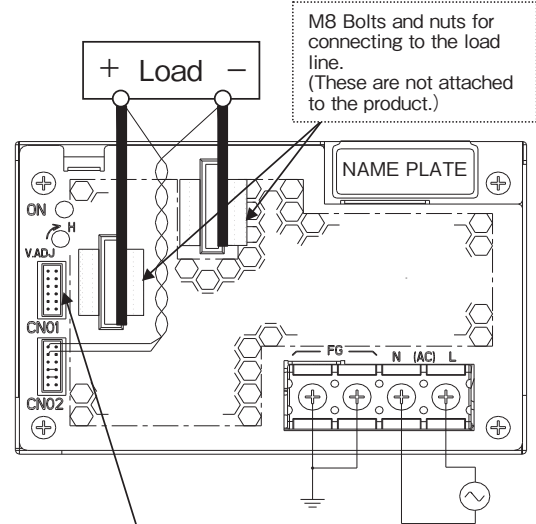

Connector : (JST) S12B-PHDSS

Remove standard attached connector, and use the harness made by the customer.
 • Housing : (JST) PHDR-12VS
 • Contact : (JST) SPHD-001T-P0.5
 2-"+" of load, 4-"-" of load should be connected.
 7-8, 9-10 : should be shorted
 *Please use wire for contact and crimping tool specified by maker.

Connecting circuit with CN01 or CN02 connector

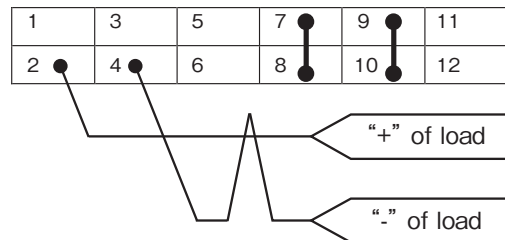

5 Remote ON/OFF control required

- ① Remove standard attached connector, and use the harness made by the customer and connect external signal to between CNT and TOG terminal.
- ② "TOG" terminal is ground for "CNT" terminal.
In case this function is not used, please short between CNT and TOG terminal.

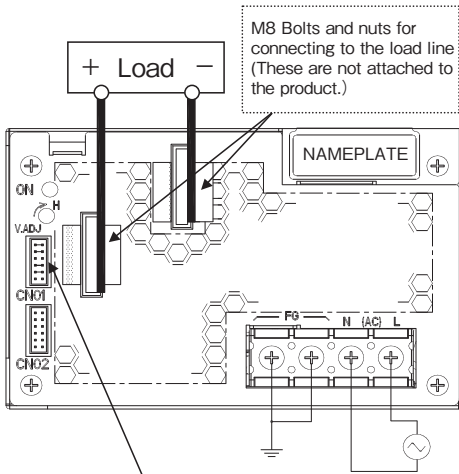

Connector : (JST) S12B-PHDSS

Remove standard attached connector, and use the harness made by the customer.

- Housing : (JST) PHDR-12VS
- Contact : (JST) SPHD-001T-P0.5

1-2, 3-4, 7-8 : should be shorted

9 : CNT
Should be connected to ON/OFF control signal.

10 : TOG
Should be connected to Signal Ground.

*Please use wire for contact and crimping tool specified by maker.

Connecting circuit with CN01 or CN02 connector

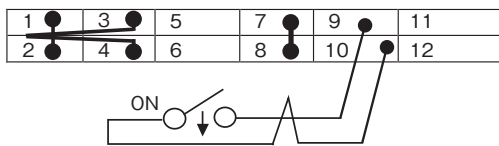

6 PF signal output required

- ① PF signal is an open collector output, therefore PF signal outputs is shown in circuit below.
- ② "TOG" terminal is ground for "PF" terminal.

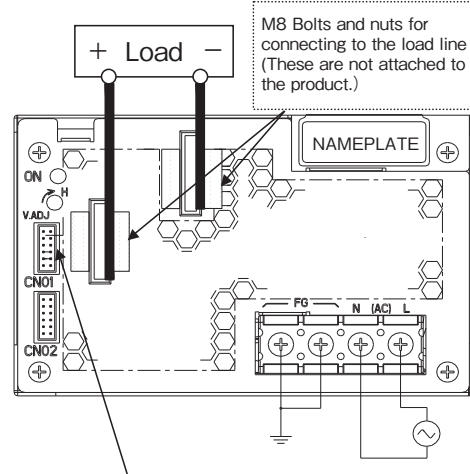

Connector : (JST) S12B-PHDSS

Remove standard attached connector, and use the harness made by the customer.

- Housing : (JST) PHDR-12VS
- Contact : (JST) SPHD-001T-P0.5

1-2, 3-4, 7-8, 9-10 : should be shorted.

11 : PF
Should be connected to PF signal output

12 : TOG
Should be connected to Signal Ground.

*Please use wire for contact and crimping tool specified by maker.

Connecting circuit with CN01 or CN02 connector

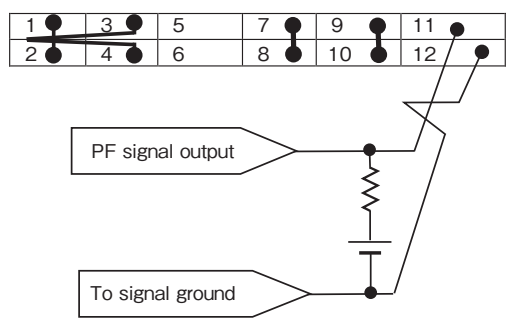

2. Functions and Precautions

1 Input Voltage Range

Input voltage range is single phase 85–265VAC (47–63Hz). Input voltage, which is out of specification, may cause unit damage. Rated input voltage range fix during safety standard application is from 100V to 240VAC (50/60Hz).

While applying input voltage from 85VAC to 90VAC, output load current derating is required.

2 Output Voltage Range

Output voltage is set to the rated value at shipping. V.ADJ trimmer on the front panel side is use to adjust the output voltage within the range specified. Output voltage trimming range is within -20%–+20% of the rated output voltage (48V, 60V model: -20% –+10%). Turn the trimmer clockwise to increase output voltage. Take note when the output voltage is increased excessively over voltage protection (OVP) function may trigger and output voltage will shut down.

Use the output power of the power supply below the rated output power value when you raise the output voltage.

3 Over Voltage Protection (OVP)

The OVP function (Inverter shut down method, manual reset type) is provided. OVP function operates within 125-145% of the rated DC output voltage value (3-7V model: 125-140%, 36V model: 125-138%, 48V, 60V model: 115-125%), and the output will be shut down when OVP function triggers. When OVP function operates, the input power is cut off for a few minutes, and then power is re-input or remote ON/OFF control signal shall be input for recovery of the output. OVP value is fixed and can not be adjusted.

4 Over Current Protection (OCP)

The OCP function (Constant current limiting, Time delay shutdown type) is provided. OCP function operates when the output current exceeds 105% of maximum DC output current specification and the over current or short circuit condition continues 5-second or more, the output will be shut down. When the OCP is triggered, the input power is cut off for a few minutes, and then power is re-input or remote ON/OFF control signal should be input for recovery of the output. The OCP setting is fixed and not to be adjusted externally.

5 Over Temperature Protection (OTP)

Over temperature protection function (manual reset type) is provided. When ambient or internal temperature rises abnormally, OTP will shut down the output. When OTP is triggered, input power is cut off and allow sufficient cooling to reset the OTP function. Then power is re-input or remote ON/OFF control signal should be input for recovery of the output.

6 Low Output Detection Circuit (PF)

Low output voltage detection circuit is provided. Power Fail signal (PF signal) will output when output voltage decrease by either the drop or brown out of the input voltage or OCP, OVP and OTP function operation. PF signal will turn "High" level to indicate the abnormal status of the power supply when the output voltage decrease to 80% of the output voltage setting value. However, there is a possibility that PF signal may not output during parallel operation. The PF signal circuit is insulated from the power supply input and output circuit and it is an open collector. TOG terminal is ground for PF terminal.

When the Built-in Fan Motor of this power supply unit stops, PF signal will turn to "H" and the output power will shut down. The Built-in Fan Motor is a component with lifetime. We recommend a periodic replacement. Please contact our sales office. Replacement is at customer's expenses.

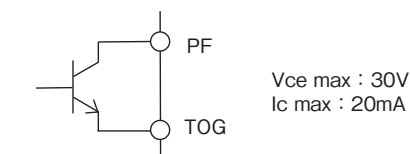

7 Remote Sensing (+S, -S terminal)

Remote sensing function is provided to compensate for voltage drop across the wiring from the power supply output terminals to the load input terminals. Connect "+S" terminal to "+" terminal of the load and "-S" terminal to "-" terminal of the load with sensing wires. The total line voltage drop (+ side line and - side line) shall be less than 0.3V. In case that sensing line is too long, it is necessary to put an electrolytic capacitor across the load terminals. Please take note that the electrolytic capacitor has generation of heat etc. done by the ripple current depending on connected load. Therefore, the electrolytic capacitor must have a ripple current allowance higher than the output ripple current. If CN01 (or CN02) is in use, terminal +S, -S for CN02 (or CN01) must be in open condition.

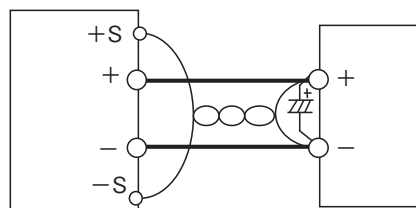

When the function of remote sensing is not in used, connect +S terminal to +V terminal, and -S terminal to -V terminal by the attachment connector.

If remote sensing terminals are opened, the stability and the accuracy of the output deteriorate. Therefore, terminal +S, -S must be connected.

8 Remote ON/OFF Control

Remote ON/OFF control is provided. Output can be remotely switch ON and OFF by using CNT terminal and TOG terminal even though input is connected. The output is turned to ON when TOG and CNT terminals are shorted and output is turned to OFF when these terminals are opened. When the function is not used, connect TOG and CNT terminals with short piece. The standards for this function are as follows. "TOG" terminal is ground for "CNT" terminal.

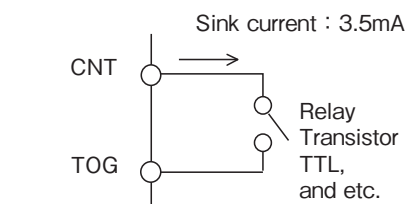

The Mode of control

CNT Level for TOG Terminal	Output	Built-in Fan Motor
Short or L (0–0.8V)	ON	Rotate
Open or H (2.4–12V)	OFF	Stop

- 1) TTL compatible. The maximum input voltage to CNT terminal is 12V, and the maximum allowable reverse voltage is -1V. The sink current of CNT terminal is 3.5mA.
- 2) Output ON/OFF control can be enable by a switch, relay or a transistor ON/OFF. When CNT terminal—TOG terminal is shorted power supply is turn ON, and when CNT terminal—TOG terminal is opened power supply is turn OFF.
- 3) Remote ON/OFF control circuit is isolated from the input and output circuit of power supply.

It is possible to use it regardless of the positive and negative of the power supply output.

Please be aware that if CNT terminal and TOG terminal is short and input voltage is gradually increase, this will trigger the low output voltage detector protection circuit and will result to output voltage shut down.

When the low output voltage detector protection circuit is triggered, the input power is cut off for a few minutes, and then power is re-input or remote ON/OFF control signal should be input for recovery of the output.

9 Output Ripple & Noise

Maximum ripple & noise value in specifications is measured according to measurement circuit specified by JEI-TA-RC9131A. When Load lines are longer, ripple & noise becomes larger. In this case, electrolytic capacitor, film capacitor, etc. might be necessary to use across the load terminal. The output ripple & noise cannot be measured accurately if the probe ground lead of oscilloscope is too long.

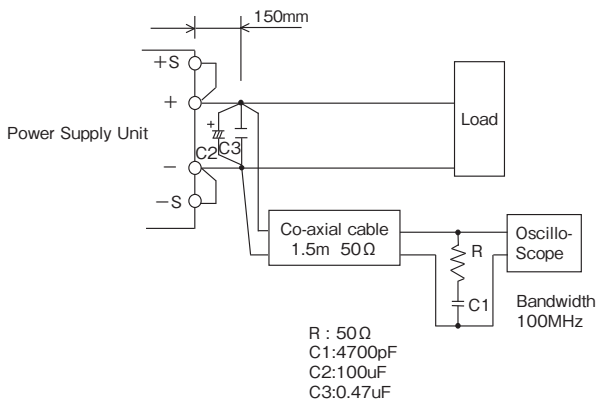

10 Series Operation

For series operation, either method (A) or (B) is possible. There might be a step in the rise waveform during series operation.

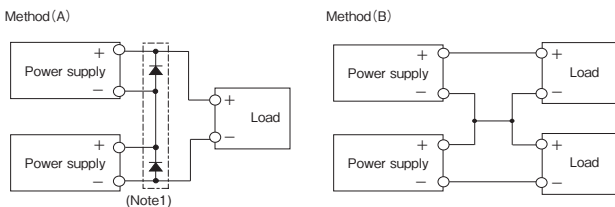

(Note1) Please connect a diode for by-pass when using method (A) of the series operation.

Please use the diode with rated forward current is equal or more than load current and that the rated maximum reverse voltage is higher than output voltage for each power supply.

11 Parallel Operation

Current balancing function is provided. Either of operations mode (A) or (B) is possible.

(A) To Increase the Output Current

Current balancing function activates by connecting PC-to-PC terminal and COM-to-COM terminal, and output current of each power supply is equivalently

supplied to load. Wires to PC terminals shall be as short as possible, same length and twisted.

There is a possibility that output could be unstable caused by external noise. For this case, disconnect COM terminal and connect -S terminal from parallel power supply to a single point on the load. Please refer connection Method (A)-2.

- 1) Adjust the output voltage of each power supply to be same value within 1% or 100mV, whichever is smaller.
- 2) Use same length and type of wires for all load lines.
- 3) Maximum value of output current in parallel is up to 80% of all paralleled models. The purpose of the current balancing function is the static power-up. Therefore the output voltage might decrease according to the condition of dynamic load. There might be a step in the rise waveform during parallel operation.
- 4) Up to 5 units can be connected in parallel.

(B) To Use as a Backup Power Supply

- 1) Set power supply output voltage higher by the forward voltage drop of diode.
- 2) Adjust the output voltage of each power supply to be same value.
- 3) Use within the specifications for output voltage and output power.

Method (A)-1

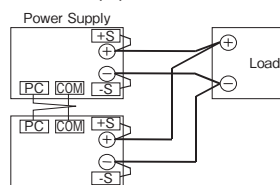

Method (A)-2

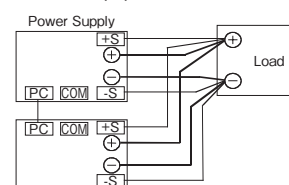

Method (B)

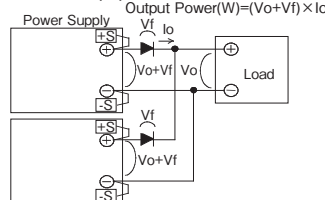

12 Isolation Test

Isolation resistance between output and FG (chassis) shall be more than 100MΩ at 500VDC and between output and CNT·PF shall be more than 10MΩ at 100VDC. For safety operation, voltage setting of DC isolation tester must be done before the test. Ensure that it is fully discharged after the test.

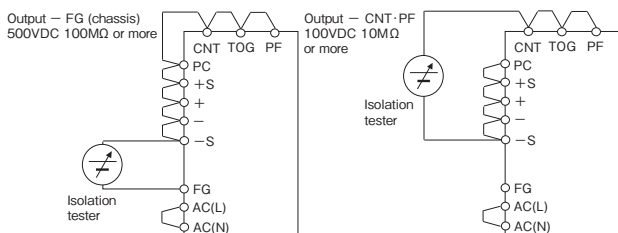

13 Withstand Voltage

This series is designed to withstand 3.0kVAC between input and output, 2.0kVAC between input and FG (chassis), 500VAC (60V model : 651VAC) between output and FG (chassis), and 100VAC between output and CNT·PF terminal each for 1 minute. When testing withstand voltage, set current limit of withstand voltage test equipment at 20mA.

(Output-FG (chassis) : 300mA (60V model : 390mA), Out

put- CNT·PF : 100mA).

The applied voltage must be gradually increased from zero to testing value and then gradually decreased for shut down. When timer is used, the power supply may be damaged by high impulse voltage at timer switch on and off. Connect input and output as follows. If output is left open during test, output voltage might appear momentarily.

This product have monolithic ceramic capacitor in secondary circuit to frame ground.

Some of the withstand voltage tester may generate high voltage at the matching with monolithic ceramic capacitor and may cause the unit damage.

So, please check the waveform of test voltage.

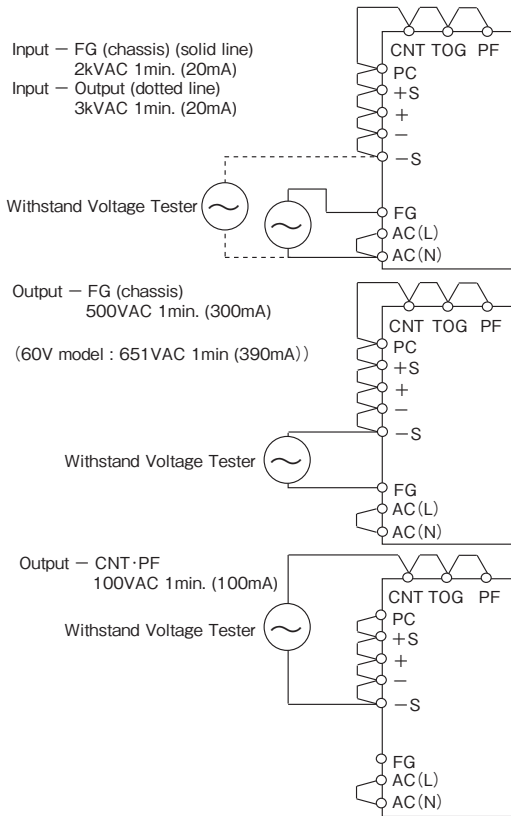

14 Output Voltage External Control (PV)

(A) Control by External Voltage

Output voltage external control function is provided. Output voltage can be varied by applying an external voltage (1-6V) to "PV" terminal and "COM" terminal. Note if an external voltage is not applied, there will be no output. Please consider the following characteristics below when operating the unit.

Connection Method

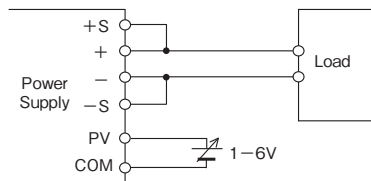

Output Voltage Linearity

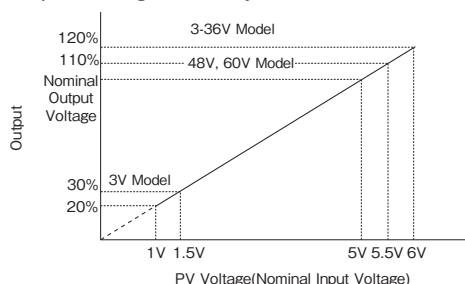

Note: Only as for the model of 3V output, the output voltage is used from 30% to 120% at the PV voltage is from 1.5V to 6.0V

Note: Only as for the model of 5-36V output, the output voltage is used from 20% to 120% at the PV voltage is from 1V to 6.0V

Note: Only as for the model of 48V, 60V output, the output voltage is used from 20% to 110% at the PV voltage is from 1V to 5.5V.

Output Voltage Derating

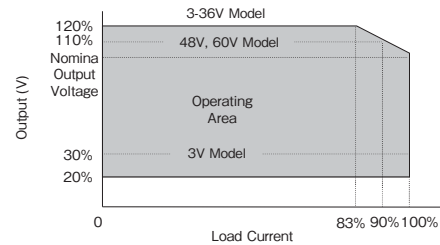

Note: Only as for the type of 48V, 60V output, the maximum output voltage is used up to 110% at 90% load current.

(B) Control by External Variable Resistor

"PV" terminal and "COM" terminal usage is the same as explained in section ["control by external voltage"]. But in this method voltage for control is supplied through REF terminal. Variable resistor is connected between REF terminal and COM terminal and the middle point of variable resistor is connected to PV terminal. Please use the output voltage within 20% - 120% of rated output voltage value (3V model : 30% - 120% , 48V, 60V model : 20% - 110%). Wires for control lines must be twisted wire or shielded wire. In addition, maximum variable voltage when control by external variable resistor is rated output voltage (100%). When output voltage must be externally control to 120% of rated output voltage (110% for 48V, 60V model), please follow the following procedure.

- (1) PV terminal and REF terminal is short by using standard connector supplied.
- (2) Set the power supply output voltage to maximum value of the output voltage variable range mentioned in specification standard by adjusting V.ADJ volume at the front panel.
- (3) Remove standard connector after input is cut off.
- (4) Connect external variable resistor (50kΩ) between REF terminal and COM terminal. Then connect middle point of external variable resistor to PV terminal. (sensing current is 1.4mA)

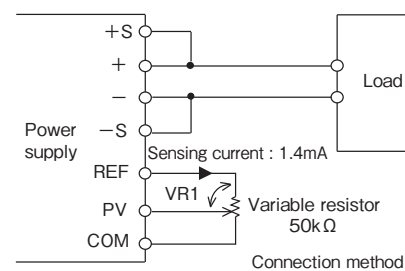

When output voltage is over rated value, please make sure that maximum output power is below rated value. Moreover, when output voltage is below rated value, please make sure that maximum output current is below rated value.

Please consider the following characteristic during usage.

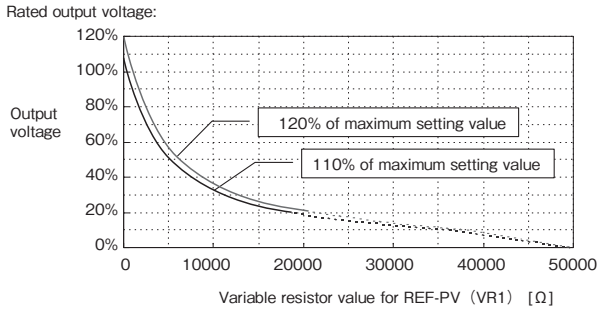

* Adjustable output voltage within 20% (3Vmodel : 30%) of output (less than 1V of PV voltage) is proportional to PV voltage and has a linear characteristic. However, for output voltage within 10% of output (about less than 0.5V of PV voltage), output will go into intermittent mode and ripple voltage becomes large, also irregular sound is release from the power supply. However, it is not damage. There will also be cases of the power supply shutting down triggered by under voltage lock out protection function. With output shutting down, low output detection function (PF) triggers the PF signal and set it to "H", and also output LED is switch off. Under voltage lock out protection mode, switch off input for a few minutes and then switch on input again for recovery. Recovery from under voltage lock out is also possible by turning remote ON/OFF control signal OFF and ON. Under voltage detection value uses an automatic tracking mode, which follows the output voltage and constantly correspond to the 70% -80% of output voltage with a protection function mode. Base on the explanation above, we will kindly exclude the usage of adjustable output voltage within 20% of the output voltage from the product warranty. For application that requires variable output voltage within 20% of output voltage, please kindly consider the above contents prior to operation. For application that requires output voltage below 20% , due to different type of application for the user's system, there might be a situation (behavior) different from the one mentioned above. Therefore please check with the user system.

15 Output Peak Current

For model with output peak current, please meet the following condition.

Reduce peak current value according to output derating as section 4-1.

The output is shut down by protection circuit when rated current and continuous peak output time (τ) exceeds rated value during usage.

When protection circuit is activated, input is temporarily cut off for a few minutes and then power is re-input or remote ON/OFF control signal should be input for recovery of the output.

- Input voltage range : AC180V - 265V
- Continuous Peak output time (τ) : Within 10 seconds
- Peak output current (I_p) : Within the rated peak output current
- Duty : up to 35%

$$\text{Duty} = \frac{\tau}{T} \times 100 (\%)$$

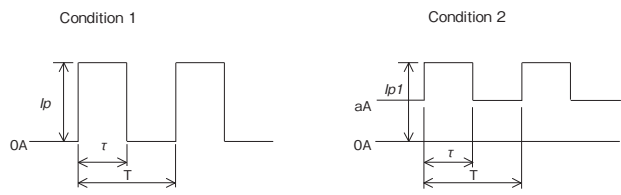

$$\sqrt{I_p^2 \times \frac{\tau}{T}} \leq I_{rms \max} \quad \sqrt{I_p1^2 \times \frac{\tau}{T} + a^2 \times (1 - \frac{\tau}{T})} \leq I_{rms \max}$$

- I_p, I_p1 : Peak output current (A)
- I_{rms} : Effective current (A)
- τ : Peak current pulse width (sec)
- T : Cycle (sec)

Model	I _{rms} max
HWS1000-7	94.6A
HWS1000-12	59.1A
HWS1000-15	47.3A
HWS1000-24	34.6A
HWS1000-36	23.0A
HWS1000-48	17.2A
HWS1000-60	13.8A

3. Mounting Directions

1 Output Derating

Mounting directions are as follows.
 Standard mounting method is (A). Methods (B), (C) and (D) are also possible.
 Mounting methods besides (A),(B),(C) and (D) (example : (E) and (F)) are inhibited.

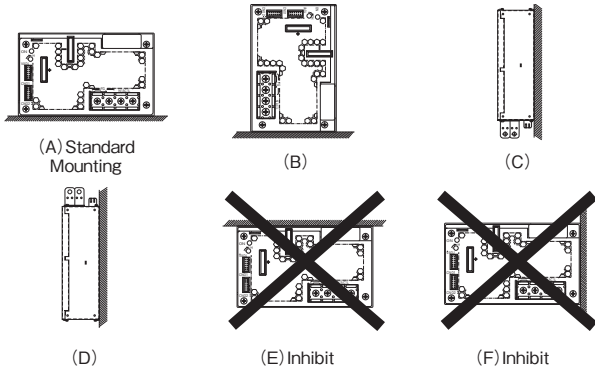

HWS1000 Output Derating

3, 5V Ta(°C)	6-60V Ta(°C)	LOAD (%)			
		A	B	C	D
-10 - +35	-10 - +35	100	100	100	100
40	50	100	100	100	100
71	71	50	50	50	50

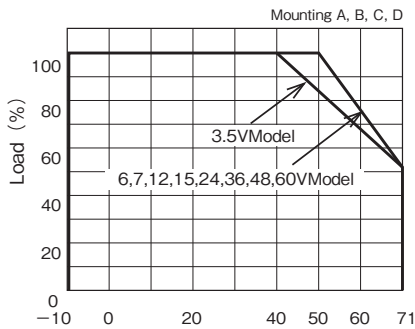

2 Mounting Method Caution

- (1) This Power supply unit is a forced air-cooling system with a built-in fan.
- (2) This power supply has ventilating holes on the front and back panels.
 Keep these areas freely more than 100mm from front side and more than 50mm from rear side.
- (3) Please note that ventilation will be worsened in a dusty environment.
- (4) Built-in fan is limited life part, which require periodic replacement. (Replacement will be charged).
- (5) The ambient temperature of this power supply is less than 50mm from the center of a front side.
- (6) The maximum allowable penetration of mounting screw is 6mm.
- (7) Recommended torque for mounting screw (M4) is 1.27N·m.

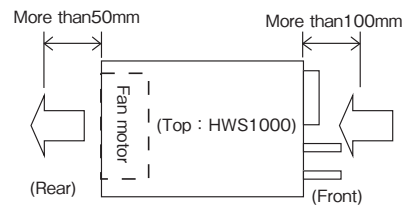

HWS

HWS HD

HWS ME

HWS-P

Instruction Manual

4. Wiring Method

- (1) The output load line and input line shall be separated and twisted to improve noise sensitivity.
- (2) The sensing lines shall be twisted or shield wire and separated from the output lines.
- (3) Use all lines as thick and short as possible to make lower impedance. Wires are to be twisted or use shield wire to improve noise sensitivity.
- (4) Attaching a capacitor to the load terminals can eliminate noise.
- (5) FG terminal of this power supply is functional earthing. For safety purposes, connect protective earthing terminal to the mounting set ground terminal.
- (6) Recommended torque for the terminal piece:

Input terminal (M4 screw):	1.27 N·m
Output terminal (M8 Bolt & Nut):	10.8N·m

- (7) Recommended wiring

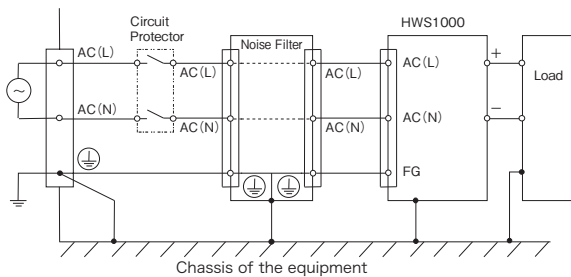

Recommended circuit protector: AC250V20A
 Recommended noise filter: RSEN-2020 (TDK-Lambda)

- (8) M4 screw for output terminal might damage the terminal's inner thread. This is mainly caused by the M4 screw's unthread section. Therefore, please select a washer, spring washer, etc. to avoid unthread screw section from penetrating into output terminal inner section.

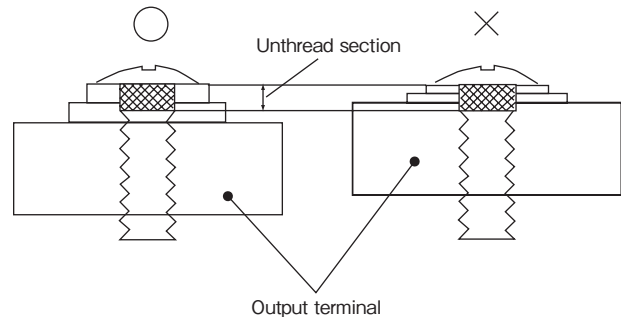

5. External Fuse Rating

Refer to the following fuse rating when selecting the external fuses for input line. Surge current flows when line turns on. Use slow-blow fuse or time-lag fuse. Do not use fast-blow fuse. Fuse rating is specified by in-rush current value

at line turn-on. Do not select the fuse according to input current (rms.) values under the actual load condition.

HWS1000:20A

6. Troubleshooting

Before concluding that the unit is at fault, make the following checks.

- (1) Check if the rated input voltage is apply.
- (2) Check if the wiring of input and output is correct.
- (3) Check if the I/O terminal connection is properly tightened by a regulated tightening torque.
- (4) Check if the wire material is not too thin.
- (5) Check if the output voltage control (V.ADJ) is properly adjusted. OVP might be triggered and output is cut off.
- (6) Check if the wiring of "+S" and "-S" terminal is correct. If in open condition, the stability and the accuracy of the output deteriorate.
- (7) If use function of the remote ON/OFF control, check if the remote ON/OFF control connector is not opened. If in open condition, output is cut off.
- (8) Check if the built-in fan is not stopped. Is fan stopped by something irregulars or dust, etc. If fan stops, the PF signal is turn on.

Moreover, the output is intercepted with the protection circuit if fan stops.

Fans are the limited life parts.

- (9) This power supply has ventilating holes on the front and back panels. Check if there is any irregulars or dust, etc.
- (10) Is the main body of the power supply abnormally hot? Please turn on the input again after allowing the unit to cool down sufficiently. The output shut down by over temperature protection function.
- (11) Check if the output current and output power is not applied over specification.
- (12) Check if the input voltage wave is sinusoidal. If this power supply unit is connected to a UPS, input voltage wave might not be sinusoidal. An audible noise is emitted from the power supply unit.
- (13) Audible noise can be heard during Dynamic-Load operation.

7. Warranty

This product is warranted for a period of 5 years from the date of shipment. As for the breakdown under a normal use during free warranty term, repair is at free of charge. However, the Built-in Fan Motor replacement is for a fee. Please contact your nearest sales office for replacement.

The Fan-life has limitation. Therefore, periodic maintenance by replacing the life-expired fan is required. The following figure shows the life of fan.

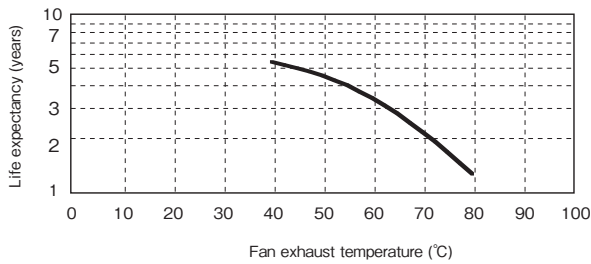

*Life expectancy

Fan exhaust temperature	45°C	45,000 hours
Fan exhaust temperature	80°C	11,000 hours

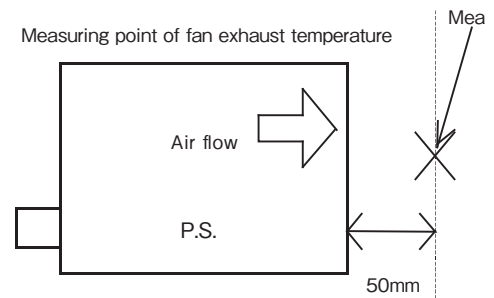

Conditions of usage at the free of charge warranty are as follows.

- (1) Average operating temperature (ambient temperature of the power supply unit) is 40°C
- (2) Average load factor is 80% or less
- (3) Installation method: Standard installation. However, the maximum rating is within the output derating.

Following cases are not covered by warranty.

- (1) Improper usage like dropping products, applying shock and defects from operation exceeding specification of the units.
- (2) Defects resulting from natural disaster (fire, flood).
- (3) Unauthorized modifications or repair by the buyers.
- (4) Defects not cause by TDK-Lambda.

8. Option

1 Fan unit for replacement

We have prepared an optional fan unit for replacement.

Name of fan unit for replacement	Applicable models	Appearance	Pin assignments	Price								
1500-FAN-01	HWS1000 HWS1500 HWS1800T (of standard specifications)	 Wind direction	Housing = XHP-3 (J.S.T.) Contact = SXH-001T-P0.6 (J.S.T.) <table border="1"> <tr> <th>Pin No.</th> <th>Description</th> </tr> <tr> <td>1</td> <td>Power supply</td> </tr> <tr> <td>2</td> <td>Fan alarm</td> </tr> <tr> <td>3</td> <td>GND</td> </tr> </table> Length of fan harness = 65 ± 10mm	Pin No.	Description	1	Power supply	2	Fan alarm	3	GND	Open
Pin No.	Description											
1	Power supply											
2	Fan alarm											
3	GND											

Ask us for replacement of the fan. This will be a charged service. If you are replacing the fan by yourself, note the following.

- *1. Be careful in handling the fan unit so as not to cause an impact by dropping it or hitting it, etc.
- *2. Shut down the input before starting the replacement operation.
- *3. Check that there are no loose parts in connectors or harness tucking, etc.
- *4. Safety standards (UL, CE, etc.) are not applicable.

2 Insulation tube for HWS1000

The following insulation tube can be used for output terminal.

•TCV-2001 (shinagawa shoko)

Please confirm shape and size from manufacturer catalog.

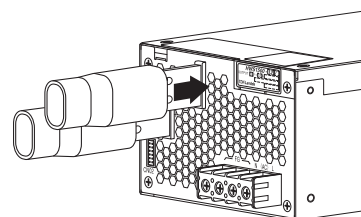

Example of use for insulation tube

HWS 1500 Series Instruction Manual

BEFORE USING THE POWER SUPPLY UNIT

Be sure to read the following precautions thoroughly before using this power supply unit.

Pay attention to all warnings and cautions before using the unit. Incorrect usage could lead to an electric shock, damage to the unit or a fire hazard.

⚠ WARNING

- Do not make unauthorized changes to power supply unit, otherwise you may have electric shock and void your warranty.
- Do not touch the internal components; they may have high voltage or high temperature. You may get electric shock or burned.
- When the unit is operating, keep your hands and face away from it; an accident may injure you.
- Do not use unit under unusual condition such as emission of smoke or abnormal smell and sound etc. It might cause fire and electric shock.
In such case, please contact us; do not repair by yourself, as it is dangerous for the user.
- Do not drop or insert anything into unit. It might cause failure and fire, when using the unit under such condition.
- Do not operate these units at the condition of condensation. It may cause fire and electric shock.
- Power supplies with an output voltage of 48Vdc or less must be earthed in the end use equipment to maintain SELV. If the outputs are not earthed, they must be considered hazardous and must not be made user accessible.
- Power supplies with an output voltage of 60Vdc are considered to be non-SELV. As a result of this, the output must be guarded or a deflector fitted during installation to avoid a SERVICE ENGINEER making inadvertent contact with the output terminals, or dropping a tool onto them. The output of this product must not be connected to a SELV circuit.

Note : CE MARKING

- CE Marking when applied to a product covered by this handbook indicates compliance with the low voltage directive (2006/95/EC) in that it complies with EN60950-1.

⚠ CAUTION

- This power supply is primarily designed and manufactured to use and enclose in other equipment.
- This power supply unit has a built-in fan for air-cooling. Do not block air intake and exhaust. It might cause fire.
- Input voltage, Output current, Output power, ambient temperature and ambient humidity should be used within specifications, otherwise the unit will be damaged.
- The unit might be broken down by accident or unexpected situation. For application equipment, which requires very high reliability (nuclear related equipment, traffic control equipment, medical equipment, etc.), please provide fail safety function in the equipment.
- Do not make an improper wiring to input and output terminals. It may cause damage.
- Do not use in environment such as strong electromagnetic field, erosive gas etc, or any environment where conductive foreign substance may enter.
- Do not operate and store this unit at the condition of condensation. In such case, waterproof treatment is necessary.
- Do not operate this unit after it falls down.
- The output voltage of this power supply unit is considered to be a hazardous energy level (The voltage is 2V or more and the electric power is 240VA or more), prevention from direct contact with voltage output is highly necessary. While installing or servicing this power supply unit, avoid dropping tools by mistake or direct contact with voltage output. This might cause an electric shock.
While repairing this power supply unit, the AC input power must be switch off and the I/O terminal voltage should be less than the safety level.

1. Terminal Explanation

Please pay extra attention to the wiring. Incorrect connection will damage the power supply.

- When connecting input and output wiring, input AC-Line should be off.
- Input wiring and output wiring shall be separated, otherwise noise susceptibility of power supply unit will be weak.

- The protective earth (PE) must be connected to the instrument chassis and the chassis of this power supply unit.
- Remote sensing lines shall be twisted or use the shielded wire.
- Remote ON/OFF control lines shall be twisted or use the shielded wire.

1 Front Panel Explanation

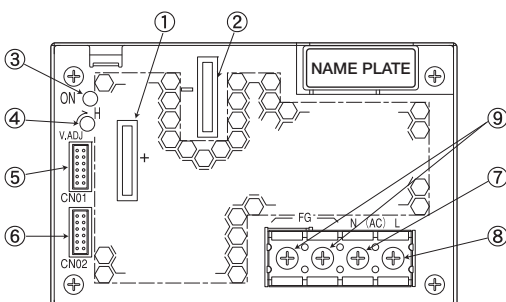

- ① + : + Output terminal
- ② - : - Output terminal
- ③ ON : Output (Power On) indication green LED
(The indicator turns on when the power supply output is in normal operating condition.)
- ④ V.ADJ : Output voltage adjust trimmer (The output voltage rises when trimmer is turned clockwise.)
- ⑤ CN01 : } Remote sensing, ON/OFF control signal, Current balance signal,
- ⑥ CN02 : } Output voltage external control signal and Power fail signal output connector.
- ⑦ N : AC input terminal N : Neutral line
- ⑧ L : AC input terminal L : Live Line (Fuse in line)
- ⑨ FG : Function Ground terminal (Frame ground)

2 CN01, CN02 Connector pin configuration and Function

CN01, CN02 pin configuration and function are the same.

They are connected to each other in this power supply unit.

When the pin of CN01 side is shorted the same function pins of CN02 side are shorted.

Please note that the function cannot be separately set with CN01 and CN02.

	Pin No.	Configuration	Function
	1	+ V	Connected to + Output terminal in this Power supply unit. (+V terminal can not supply load current.)
	2	+ S	Remote sensing terminal for + output (For remote sensing function, which compensates for line drop between power supply terminals and load terminals. Connect to +V terminal when remote sensing function is unnecessary)
	3	- V	Connected to - Output terminal in this Power supply unit. (-V terminal can not supply load current)
	4	- S	Remote sensing terminal for - output (For remote sensing function, which compensates for line drop between power supply terminals and load terminals. Connect to -V terminal when remote sensing function is unnecessary)
	5	PC	Current balance terminal (For output current balancing in parallel operation.)
	6	COM	Ground for PC and PV signal.
	7	PV	Output voltage external control terminal (For power supply output voltage control with an external voltage. Connect it with the terminal REF when PV function is unnecessary.)
	8	REF	Reference Voltage terminal for Output voltage control (REF and PV are connected when shipping.)
	9	CNT	Remote ON/OFF control terminal (When the CNT is pulled to TTL low, the power supply turns on.)
	10	TOG	Ground for CNT and PF signal.
	11	PF	Power fail signal output terminal. (As the output voltage drops, FAN stops and AC input voltage down, open collector output, "Power Fail" signal will output "High".)
	12	TOG	Ground for CNT and PF signal.

CN01, CN02 are connected in this power supply unit as follows.

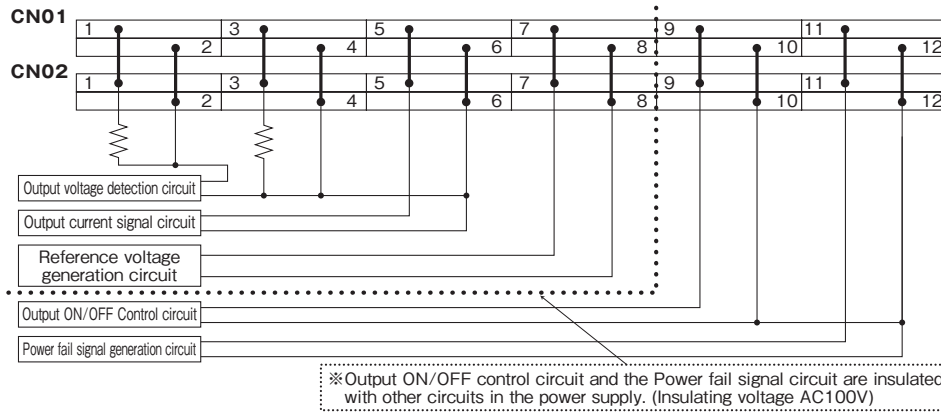

3 Basic Connection(Local sensing)

• 3-7V model

① Connect "+S" terminal to "+" terminal of output and "-S" terminal to "-" terminal of output with sensing wires.

② Connect "CNT" terminal to "TOG" terminal with wire.

③ Connect "PV" terminal to "REF" terminal with wire.

※ Please use attachment connector for each connection.

※ In the following cases, the output is shut down.

When CNT and TOG is opened.

When PV and REF is opened.

• 12-60V model

① Connect "+S" terminal to "+V" terminal and "-S" terminal to "-V" terminal with sensing wires.

② Connect "CNT" terminal to "TOG" terminal with wire.

③ Connect "PV" terminal to "REF" terminal with wire.

※ Please use attachment connector for each connection.

※ In the following cases, the output is shut down.

When CNT and TOG is opened.

When PV and REF is opened.

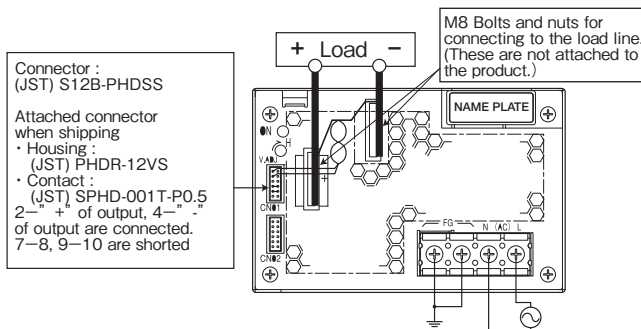

Attached connector when shipping

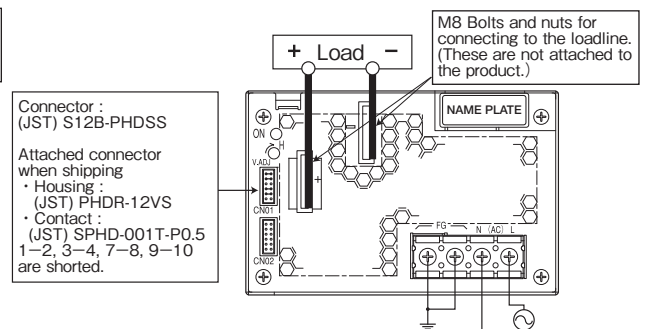
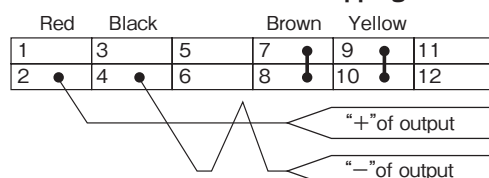

Attached connector when shipping

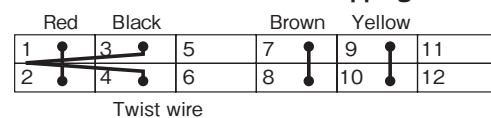

4 Remote sensing required

- ① Connect "+S" terminal to "+" terminal of load with sensing wire
 - ② Connect "-S" terminal to "-" terminal of load with sensing wires.
 - ③ Connect "CNT" terminal to "TOG" terminal with wire.
 - ④ Connect "PV" terminal to "REF" terminal with wire.
- ※ The accuracy of the output voltage will deteriorate when the sensing terminals are opened.
- ※ In the following cases, the output is shut down.
When CNT and TOG is opened.
When PV and REF is opened.

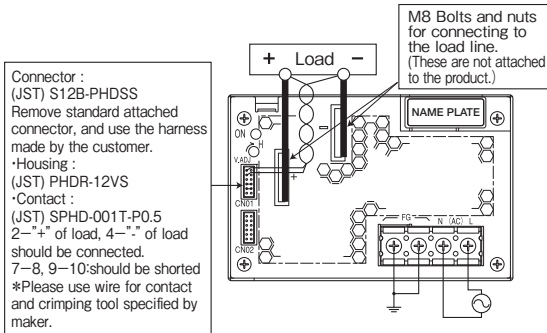

Connecting circuit with CN01 or CN02 connector

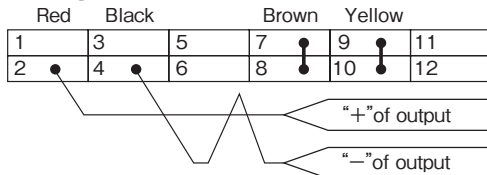

5 Remote ON/OFF control required

- ① Remove standard attached connector, and use the harness made by the customer and connect external signal to between CNT and TOG terminal.
 - ② "TOG" terminal is ground for "CNT" terminal.
- In case this function is not used, please short between CNT and TOG terminal.

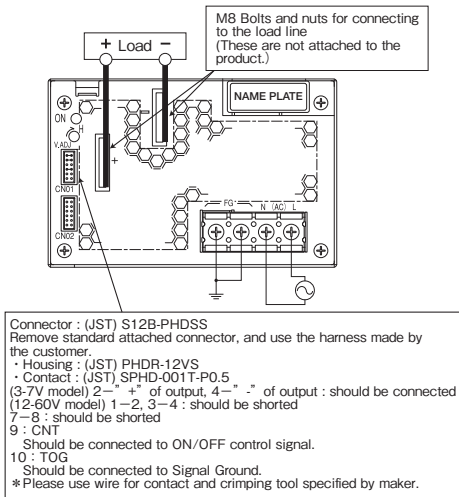

● Connecting circuit with CN01 or CN02 connector (3-7V model)

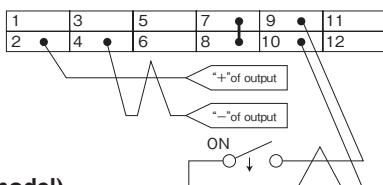

(12-60V model)

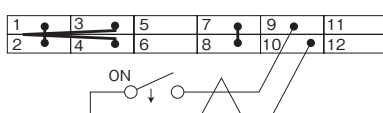

6 PF signal output required

- ① PF signal is an open collector output, therefore PF signal outputs is shown in circuit below.
- ② "TOG" terminal is ground for "PF" terminal.

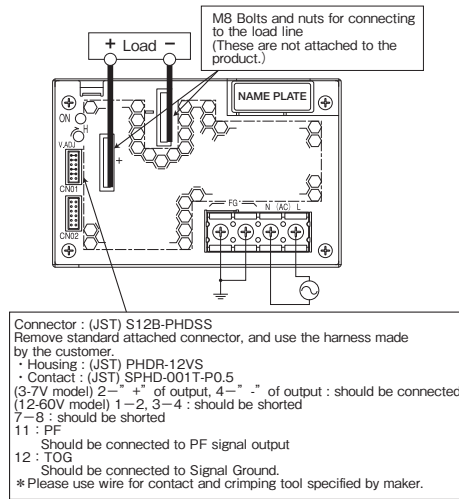

● Connecting circuit with CN01 or CN02 connector (3-7V model)

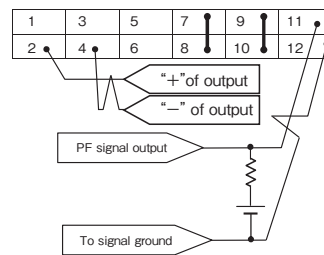

(12-60V model)

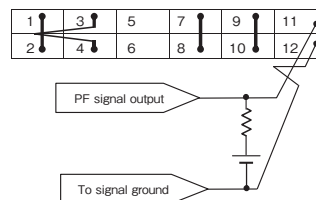

2. Functions and Precautions

1 Input Voltage Range

Input voltage range is single phase 85–265VAC (47–63Hz). Input voltage, which is out of specification, may cause unit damage. Rated input voltage range fix during safety standard application is from 100V to 240VAC (50/60Hz).

While applying input voltage from 85VAC to 90VAC, output load current derating is required.

2 Output Voltage Range

Output voltage is set to the rated value at shipping. V.ADJ trimmer on the front panel side is use to adjust the output voltage within the range specified. Output voltage trimming range is within -20% – +20% of the rated output voltage (48V, 60V Model: -20% – +10%). Turn the trimmer clockwise to increase output voltage. Take note when the output voltage is increased excessively over voltage protection (OVP) function may trigger and output voltage will shut down.

Use the output power of the power supply below the rated output power value when you raise the output voltage.

3 Over Voltage Protection (OVP)

The OVP function (Inverter shut down method, manual reset type) is provided. OVP function operates within 125-145% of the rated DC output voltage value (3-7V model: 125-140% , 36V type: 125-138% , 48V type: 115-135, 60V model: 115-125%), and the output will be shut down when OVP function triggers. When OVP function operates, the input power is cut off for a few minutes, and then power is re-input or remote ON/OFF control signal shall be input for recovery of the output. OVP value is fixed and can not be adjusted.

4 Over Current Protection (OCP)

The OCP function (Constant current limiting, Time delay shutdown type) is provided. OCP function operates when the output current exceeds 105% of maximum DC output current specification and the over current or short circuit condition continues 5-second or more, the output will be shut down. When the OCP is triggered, the input power is cut off for a few minutes, and then power is re-input or remote ON/OFF control signal should be input for recovery of the output. The OCP setting is fixed and not to be adjusted externally.

5 Over Temperature Protection (OTP)

Over temperature protection function (manual reset type) is provided. When ambient or internal temperature rises abnormally, OTP will shut down the output. When OTP is triggered, input power is cut off and allow sufficient cooling to reset the OTP function. Then power is re-input or remote ON/OFF control signal should be input for recovery of the output.

6 Low Output Detection Circuit (PF)

Low output voltage detection circuit is provided. Power Fail signal (PF signal) will output when output voltage decrease by either the drop or brown out of the input voltage or OCP, OVP and OTP function operation. PF signal will turn "High" level to indicate the abnormal status of the power supply when the output voltage decrease to 80 % of the output voltage setting value. However, there is a possibility that PF signal may not output during parallel operation. The PF signal circuit is insulated from the power supply input and output circuit and it is an open collector. TOG terminal is ground for PF terminal.

When the Built-in Fan Motor of this power supply unit stops, PF signal will turn to "H" and the output power will shut down. The Built-in Fan Motor is a component with lifetime. We recommend a periodic replacement. Please contact our sales office. Replacement is at customer's expenses.

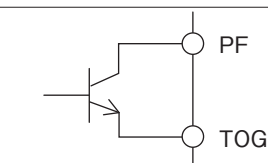

7 Remote Sensing (+S, -S terminal)

Remote sensing function is provided to compensate for voltage drop across the wiring from the power supply output terminals to the load input terminals. Connect "+S" terminal to "+" terminal of the load and "-S" terminal to "-" terminal of the load with sensing wires. The total line voltage drop (+ side line and - side line) shall be less than 0.3V. In case that sensing line is too long, it is necessary to put an electrolytic capacitor across the load terminals.

Please take note that the electrolytic capacitor has generation of heat etc. done by the ripple current depending on connected load. Therefore, the electrolytic capacitor must have a ripple current allowance higher than the output ripple current. If CN01 (or CN02) is in use, terminal +S, -S for CN02 (or CN01) must be in open condition.

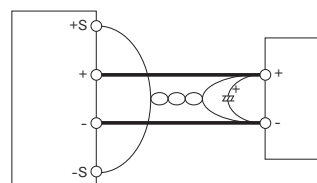

When the function of remote sensing is not in used, connect +S terminal to +V terminal, and -S terminal to -V terminal by the attachment connector.

If remote sensing terminals are opened, the stability and the accuracy of the output deteriorate. Therefore, terminal +S, -S must be connected.

8 Remote ON/OFF Control

Remote ON/OFF control is provided. Output can be remotely switch ON and OFF by using CNT terminal and TOG terminal even though input is connected. The output is turned to ON when TOG and CNT terminals are shorted and output is turned to OFF when these terminals are opened. When the function is not used, connect TOG and CNT terminals with short piece. The standards for this function are as follows. "TOG" terminal is ground for "CNT" terminal.

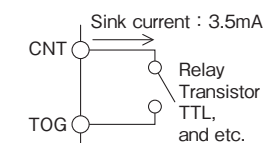

The Mode of control

CNT Level for TOG Terminal	Output	Built-in Fan Motor
Short or L (0–0.8V)	ON	Rotate
Open or H (2.4–12V)	OFF	Stop

- 1) TTL compatible. The maximum input voltage to CNT terminal is 12V, and the maximum allowable reverse voltage is -1V. The sink current of CNT terminal is 3.5mA.
- 2) Output ON/OFF control can be enable by a switch, relay or a transistor ON/OFF. When CNT terminal—TOG terminal is shorted power supply is turn ON, and when CNT terminal—TOG terminal is opened power supply is turn OFF.
- 3) Remote ON/OFF control circuit is isolated from the input and output circuit of power supply. It is possible to use it regardless of the positive and negative of the power supply output.

Please be aware that if CNT terminal and TOG terminal is short and input voltage is gradually increase, this will trigger the low output voltage detector protection circuit and will result to output voltage shut down.

When the low output voltage detector protection circuit is triggered, the input power is cut off for a few minutes, and then power is re-input or remote ON/OFF control signal should be input for recovery of the output.

9 Output Ripple & Noise

Maximum ripple & noise value in specifications is measured according to measurement circuit specified by JEITA-RC9131A. When Load lines are longer, ripple & noise becomes larger. In this case, electrolytic capacitor, film capacitor, etc. might be necessary to use across the load terminal. The output ripple & noise cannot be measured accurately if the probe ground lead of oscilloscope is too long.

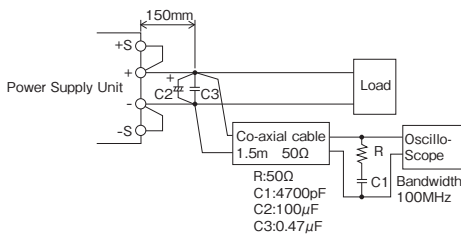

10 Series Operation

For series operation, either method (A) or (B) is possible. There might be a step in the rise waveform during series operation.

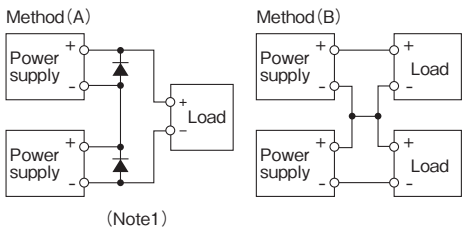

(Note1) Please connect a diode for by-pass when using method (A) of the series operation.

Please use the diode with rated forward current is equal or more than load current and that the rated maximum reverse voltage is higher than output voltage for each power supply.

11 Parallel Operation

Current balancing function is provided. Either of operations mode (A) or (B) is possible.

(A) To Increase the Output Current
Current balancing function activates by connecting PC-to-PC terminal and COM-to-COM terminal, and output current of each power supply is equivalently supplied to load. Wires to PC terminals shall be as short as possible, same length and twisted.

There is a possibility that output could be unstable caused by external noise. For this case, disconnect COM terminal and connect -S terminal from parallel power supply to a single point on the load. Please refer connection Method (A)-2.

- 1) Adjust the output voltage of each power supply to be same value within 1% or 100mV, whichever is smaller.

- 2) Use same length and type of wires for all load lines.
- 3) Maximum value of output current in parallel is up to 80% of all paralleled models. The purpose of the current balancing function is the static power-up. Therefore the output voltage might decrease according to the condition of dynamic load. There might be a step in the rise waveform during parallel operation.
- 4) Up to 5 units can be connected in parallel.
 - (B) To Use as a Backup Power Supply
 - 1) Set power supply output voltage higher by the forward voltage drop of diode.
 - 2) Adjust the output voltage of each power supply to be same value.
 - 3) Use within the specifications for output voltage and output power.
 - (C) In the case of parallel connections, it is possible to control the output voltage by adjusting the volume from only 1 unit. Choose 1 unit that would act as the master and this unit's volume will determine the output voltage. The volume on each slave units must be turned clockwise to maximum position. Then adjust the master volume to set the output voltage.

Connection for this application is shown in figure (c).

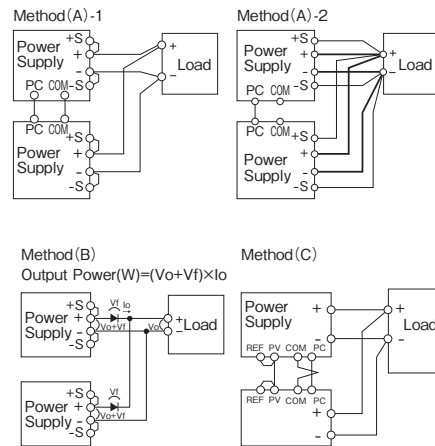

12 Isolation Test

Isolation resistance between output and FG (chassis) shall be more than 100MΩ at 500VDC and between output and CNT·PF shall be more than 10MΩ at 100VDC. For safety operation, voltage setting of DC isolation tester must be done before the test. Ensure that it is fully discharged after the test.

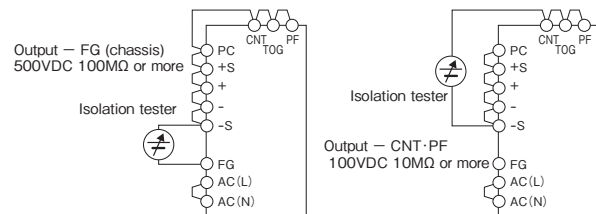

13 Withstand Voltage

This series is designed to withstand 3.0kVAC between input and output, 2.0kVAC between input and FG (chassis), 500VAC (60V model : 651VAC) between output and FG (chassis), and 100VAC between output and CNT·PF terminal each for 1 minute. When testing withstand voltage, set current limit of withstand voltage test equipment at 20mA. (Output-FG (chassis) : 300mA (60V model : 390mA), Output- CNT·PF : 100mA).

The applied voltage must be gradually increased from zero to testing value and then gradually decreased for shut down. When timer is used, the power supply may be damaged by high impulse voltage at timer switch on and off. Connect input and output as follows. If output is left open during test, output voltage might appear momentarily.

This product have monolithic ceramic capacitor in secondary circuit to frame ground.

Some of the withstand voltage tester may generate high voltage at the matching with monolithic ceramic capacitor and may cause the unit damage.

So, please check the waveform of test voltage.

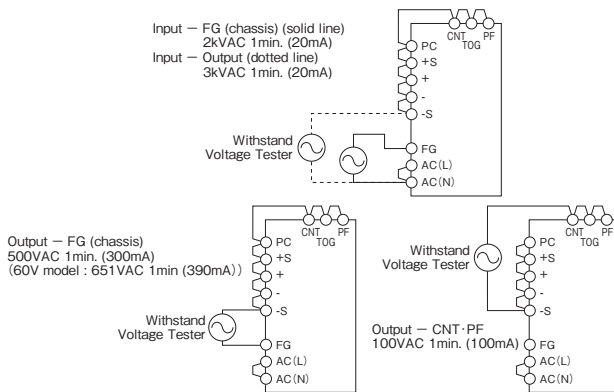

14 Output Voltage External Control (PV)

(A) Control by External Voltage

Output voltage external control function is provided. Output voltage can be varied by applying an external voltage (1-6V) to "PV" terminal and "COM" terminal. Note if an external voltage is not applied, there will be no output. Please consider the following characteristics below when operating the unit.

Connection Method

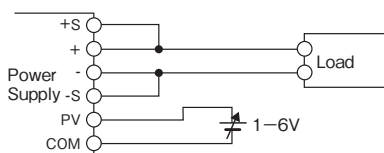

Output Voltage Linearity

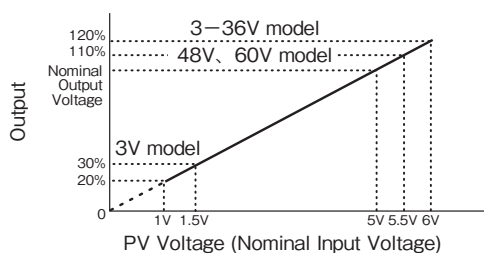

Note: Only as for the model of 3V output, the output voltage is used from 30% to 120% at the PV voltage is from 1.5V to 6.0V

Note: Only as for the model of 5-36V output, the output voltage is used from 20% to 120% at the PV voltage is from 1V to 6.0 V

Note: Only as for the model of 48V, 60V output, the output voltage is used from 20% to 110% at the PV voltage is from 1V to 5.5V

Output Voltage Derating

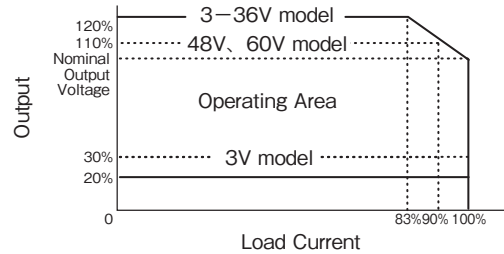

Note: Only as for the model of 48V, 60V output, the maximum output voltage is used up to 110% at 90% load current.

(B) Control by External Variable Resistor

"PV" terminal and "COM" terminal usage is the same as explained in section [control by external voltage] . But in this method voltage for control is supplied through REF terminal. Variable resistor is connected between REF terminal and COM terminal and the middle point of variable resistor is connected to PV terminal. Please use the output voltage within 20% - 120% of rated output voltage value (3V model : 30% - 120% , 48V, 60V model : 20% - 110%). Wires for control lines must be twisted wire or shield wire. In addition, maximum variable voltage when control by external variable resistor is rated output voltage (100%). When output voltage must be externally control to 120% of rated output voltage (110% for 48V, 60V model), please follow the following procedure.

- (1) PV terminal and REF terminal is short by using standard connector supplied.
- (2) Set the power supply output voltage to maximum value of the output voltage variable range mentioned in specification standard by adjusting V.ADJ volume at the front panel.
- (3) Remove standard connector after input is cut off.
- (4) Connect external variable resistor (50kΩ) between REF terminal and COM terminal. Then connect middle point of external variable resistor to PV terminal.(sensing current is 1.4mA)

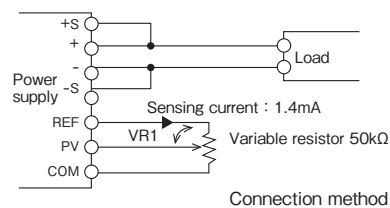

When output voltage is over rated value, please make sure that maximum output power is below rated value. Moreover, when output voltage is below rated value, please make sure that maximum output current is below rated value.

Please consider the following characteristic during usage.

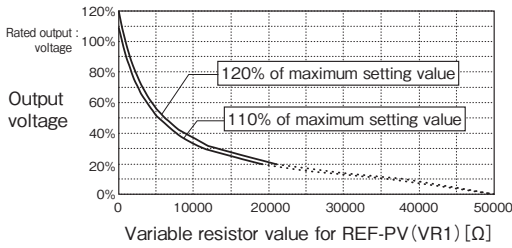

* Adjustable output voltage within 20% (3Vmodel : 30%) of output (less than 1V of PV voltage) is proportional to PV voltage and has a linear characteristic. However, for output voltage within 10% of output (about less than 0.5V of PV voltage), output will go into intermittent mode and ripple voltage becomes large, also irregular sound is release from the power supply. However, it is not damage. There will also be cases of the power supply shutting down triggered by under voltage lock out protection function. With output shutting down, low output detection function (PF) triggers the PF signal and set it to "H", and also output LED is switch off. Under voltage lock out protection mode, switch off input for a few minutes and then switch on input again for recovery. Recovery from under voltage lock out is also possible by turning remote ON/OFF control signal OFF and ON. Under voltage detection value uses an automatic tracking mode, which follows the output voltage and constantly correspond to the 70% -80% of output voltage with a protection function mode. Base on the explanation above, we will kindly exclude the usage of adjustable output voltage within 20% of the output voltage from the product warranty. For application that requires variable output voltage within 20% of output voltage, please kindly consider the above contents prior to operation. For application that requires output voltage below 20%, due to different type of application for the user's system, there might be a situation (behavior) different from the one mentioned above. Therefore please check with the user system.

15 Output Peak Current

For model with output peak current, please meet the following condition. Reduce peak current value according to output derating as section 4-1.

The output is shut down by protection circuit when rated current and continuous peak output time (τ) exceeds rated value during usage.

When protection circuit is activated, input is temporarily cut off for a few minutes and then power is re-input or remote ON/OFF control signal should be input for recovery of the output.

Input voltage range : AC180V - 265V
 Continuous Peak output time. (τ) : Within 10 seconds
 Peak output current (I_p) : Within the rated peak output current
 Duty : up to 35%
 Duty = $\frac{\tau}{T} \times 100$ (%)

Condition 1

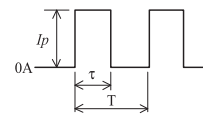

Model	Irms max
HWS1500-6	177.5A
HWS1500-7	142.0A
HWS1500-24	62.1A
HWS1500-36	41.4A
HWS1500-60	24.8A

$$\sqrt{I_p^2 \times \frac{\tau}{T}} \leq I_{rms \max}$$

Condition 2

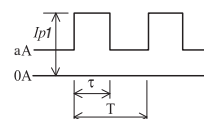

$$\sqrt{(I_p1^2 \times \frac{\tau}{T} + a^2 \times (1 - \frac{\tau}{T}))} \leq I_{rms \max}$$

I_p, I_p1 : Peak output current (A)
 I_{rms}: Effective current (A)
 τ : Peak current pulse width(sec)
 T: cycle(sec)

3. Mounting Directions

1 Output Derating

Mounting directions are as follows. Standard mounting method is (A). Methods (B), (C) and (D) are also possible. Mounting methods besides (A), (B), (C) and (D) (example: (E) and (F)) are inhibit.

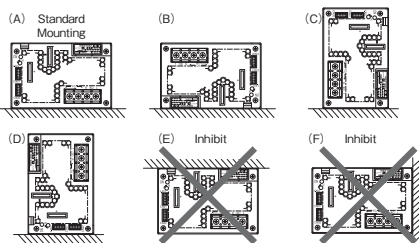

2 Mounting Method Caution

- (1) This Power supply unit is a forced air-cooling system with a built-in fan.
- (2) This power supply has ventilating holes on the front and back panels. Keep these areas freely more than 100mm from front side and more than 50mm from rear side.
- (3) Please note that ventilation will be worsened in a dusty environment.
- (4) Built-in fan is limited life part, which require periodic replacement. (Replacement will be charge).
- (5) The ambient temperature of this power supply is less than 50mm from the center of a front side.

HWS1500 Output Derating

3, 5V Ta(°C)	6-60V Ta(°C)	LOAD (%)			
		A	B	C	D
-10 - +40	-10 - +50	100	100	100	100
70	70	50	50	50	50

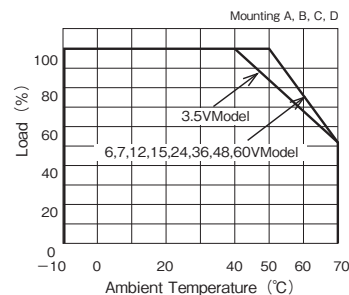

- (6) The maximum allowable penetration of mounting screw is 6mm.
- (7) Recommended torque for mounting screw (M4) is 1.27N · m.

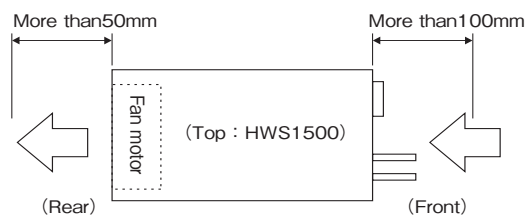

4. Wiring Method

- (1) The output load line and input line shall be separated and twisted to improve noise sensitivity.
- (2) The sensing lines shall be twisted or shield wire and separated from the output lines.
- (3) Use all lines as thick and short as possible to make lower impedance. Wires are to be twisted or use shield wire to improve noise sensitivity.
- (4) Attaching a capacitor to the load terminals can eliminate noise.
- (5) FG terminal of this power supply is functional earthing. For safety purposes, connect protective earthing terminal to the mounting set ground terminal.
- (6) Recommended torque for the terminal piece:

Input terminal (M4 screw) : 1.27 N·m Output terminal (M8 Bolt & Nut) : 10.8N · m

- (7) Recommended wiring

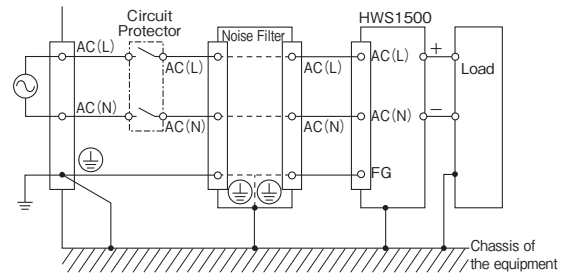

- (8) M4 screw for output terminal might damage the terminal's inner section. This is mainly caused by the M4 screw's unthread section. Therefore, please select a washer, spring washer, etc. to avoid unthread screw section from penetrating into output terminal inner section.

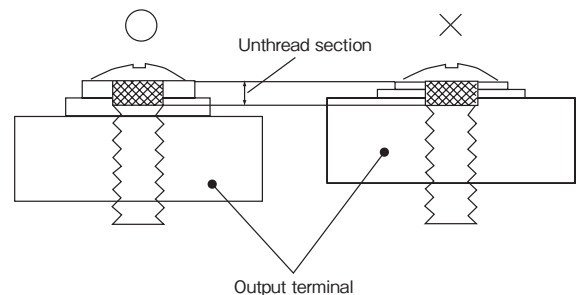

5. External Fuse Rating

Refer to the following fuse rating when selecting the external fuses for input line. Surge current flows when line turns on. Use slow-blow fuse or time-lag fuse. Do not use fast-blow fuse. Fuse rating is specified by in-rush current value at line turn-on. Do not

select the fuse according to input current (rms.) values under the actual load condition.

HWS1500 : 30A

6. Troubleshooting

Before concluding that the unit is at fault, make the following checks.

- (1) Check if the rated input voltage is apply.
- (2) Check if the wiring of input and output is correct.
- (3) Check if the I/O terminal connection is properly tighten by a regulated tightening torque.
- (4) Check if the wire material is not too thin.
- (5) Check if the output voltage control (V.ADJ) is properly adjusted. OVP might be triggered and output is cut off.
- (6) Check if the wiring of "+S" and "-S" terminal is correct. If in open condition, the stability and the accuracy of the output deteriorate.
- (7) If use function of the remote ON/OFF control, check if the remote ON/OFF control connector is not opened. If in open condition, output is cut off.
- (8) Check if the built-in fan is not stopped. Is fan stopped by something irregulars or dust, etc. If fan stops, the PF signal is turn on. Moreover, the output is intercepted with the protection circuit if fan stops. Fans are the limited life parts.
- (9) This power supply has ventilating holes on the front and back panels. Check if there is any irregulars or dust, etc.
- (10) Is the main body of the power supply abnormally hot? Please turn on the input again after allowing the unit to cool down sufficiently. The output shut down by over temperature protection function.
- (11) Check if the output current and output power is not applied over specification.
- (12) Check if the input voltage wave is sinusoidal. If this power supply unit is connected to a UPS, input voltage wave might not be sinusoidal. An audible noise is emitted from the power supply unit.
- (13) Audible noise can be heard during Dynamic-Load operation.

7. Warranty

This product is warranted for a period of 5 years from the date of shipment. As for the breakdown under a normal use during free warranty term, repair is at free of charge. However, the Built-in Fan Motor replacement is for a fee. Please contact your nearest sales office for replacement. The Fan-life has limitation. Therefore, periodic maintenance by replacing the life-expired fan is required. The following figure shows the life of fan.

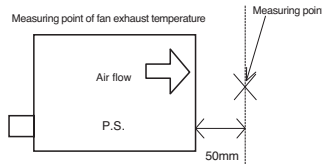
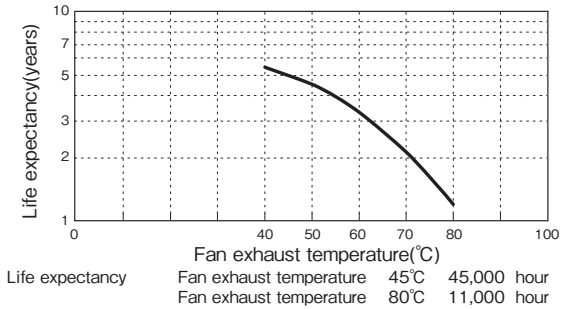

Conditions of usage at the free of charge warranty are as follows.

- (1) Average operating temperature (ambient temperature of the power supply unit) is 40°C
- (2) Average load factor is 80% or less
- (3) Installation method: Standard installation. However, the maximum rating is within the output derating.

Following cases are not covered by warranty.

- (1) Improper usage like dropping products, applying shock and defects from operation exceeding specification of the units.
- (2) Defects resulting from natural disaster (fire, flood).
- (3) Unauthorized modifications or repair by the buyers.
- (4) Defects not cause by TDK-Lambda.

8. Option

1 Fan unit for replacement

We have prepared an optional fan unit for replacement.

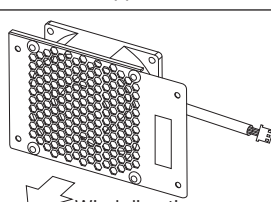
Name of fan unit for replacement	Applicable models	Appearance	Pin assignments	Price								
1500-FAN-01	HWS1000 HWS1500 HWS1800T (of standard specifications)		Housing = XHP-3(J.S.T.) Contact = SXH-001T-P0.6(J.S.T.) <table border="1" style="margin-left: auto; margin-right: auto;"> <tr> <th>Pin No.</th> <th>Description</th> </tr> <tr> <td>1</td> <td>Power supply</td> </tr> <tr> <td>2</td> <td>Fan alarm</td> </tr> <tr> <td>3</td> <td>GND</td> </tr> </table> Length of fan harness = 65 ± 10mm	Pin No.	Description	1	Power supply	2	Fan alarm	3	GND	Open
Pin No.	Description											
1	Power supply											
2	Fan alarm											
3	GND											

Ask us for replacement of the fan. This will be a charged service. If you are replacing the fan by yourself, note the following.

- *1. Be careful in handling the fan unit so as not to cause an impact by dropping it or hitting it, etc.
- *2. Shut down the input before starting the replacement operation.
- *3. Check that there are no loose parts in connectors or harness tucking, etc.
- *4. Safety standards (UL, CE, etc.) are not applicable.

2 Insulation tube for HWS1500

The following insulation tube can be used for output terminal.
 •TCV-2001 (shinagawa shoko)
 Please confirm shape and size from manufacturer catalog.

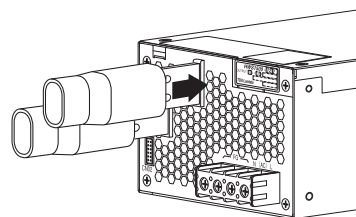

Example of use for insulation tube

HWS 1800T Series Instruction Manual

BEFORE USING THE POWER SUPPLY UNIT

Be sure to read the following precautions thoroughly before using this power supply unit.

Pay attention to all warnings and cautions before using the unit. Incorrect usage could lead to an electrical shock, damage to the unit or a fire hazard.

⚠ WARNING

- Do not make unauthorized changes to power supply unit, otherwise you may have electric shock and void your warranty.
- Do not touch the internal components; they may have high voltage or high temperature. You may get electrical shock or burned.
- When the unit is operating, keep your hands and face away from it; an accident may injure you.
- Do not use unit under unusual condition such as emission of smoke or abnormal smell and sound etc. It might cause fire and electric shock.
In such case, please contact us; do not repair by yourself, as it is dangerous for the user.
- Do not drop or insert anything into unit. It might cause failure and fire, when using the unit under such condition.
- Do not operate these units at the condition of condensation. It may cause fire and electric shock.
- Power supplies with an output voltage of 48Vdc or less must be earthed in the end use equipment to maintain SELV. If the outputs are not earthed, they must be considered hazardous and must not be made user accessible.
- Power supplies with an output voltage of 60Vdc are considered to be non-SELV. As a result of this, the output must be guarded or a deflector fitted during installation to avoid a SERVICE ENGINEER making inadvertent contact with the output terminals, or dropping a tool onto them. The output of this product must not be connected to a SELV circuit.

Note : CE MARKING

- CE Marking when applied to a product covered by this handbook indicates compliance with the low voltage directive (2006/95/EC) in that it complies with EN60950-1.

⚠ CAUTION

- This power supply is primarily designed and manufactured to use and enclose in other equipment.
- This power supply unit has a built-in fan for air-cooling. Do not block air intake and exhaust. It might cause fire.
- Input voltage, Output current, Output power, ambient temperature and ambient humidity should be used within specifications, otherwise the unit will be damaged.
- The unit might be broken down by accident or unexpected situation. For application equipment, which requires very high reliability (nuclear related equipment, traffic control equipment, medical equipment, etc.), please provide fail safety function in the equipment.
- Do not make an improper wiring to input and output terminals. It may cause damage.
- Do not use in environment such as strong electromagnetic field, erosive gas etc, or any environment where conductive foreign substance may enter.
- Do not operate and store this unit at the condition of condensation. In such case, waterproof treatment is necessary.
- Do not operate this unit after it falls down.
- The output voltage of this power supply unit is considered to be a hazardous energy level (The voltage is 2V or more and the electric power is 240VA or more), prevention from direct contact with voltage output is highly necessary. While installing or servicing this power supply unit, avoid dropping tools by mistake or direct contact with voltage output. This might cause an electrical shock.
While repairing this power supply unit, the AC input power must be switch off and the I/O terminal voltage should be less than the safety level.

1. Terminal Explanation

Please pay extra attention to the wiring. Incorrect connection will damage the power supply.

- When connecting input and output wiring, input AC-Line should be off.
- Input wiring and output wiring shall be separated, otherwise noise susceptibility of power supply unit will be weak.

- The protective earth (PE) must be connected to the instrument chassis and the chassis of this power supply unit.
- Remote sensing lines shall be twisted or use the shielded wire.
- Remote ON/OFF control lines shall be twisted or use the shielded wire.

1 Front Panel Explanation

HWS1800T Front Panel

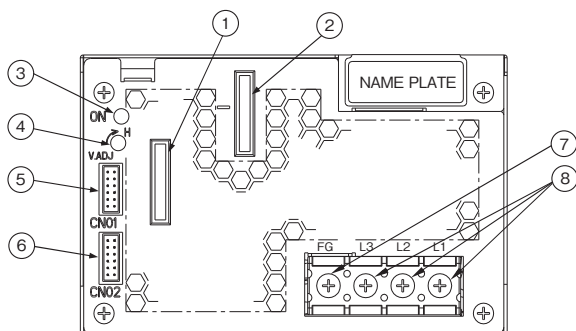

- ① + : + Output terminal
- ② - : - Output terminal
- ③ ON : Output (Power On) indication green LED
(The indicator turns on when the power supply output is in normal operating condition.)
- ④ V.ADJ : Output voltage adjust trimmer
(The output voltage rises when trimmer is turned clockwise.)
- ⑤ CN01 : } Remote sensing, ON/OFF control signal, Current balance signal,
- ⑥ CN02 : } Output voltage external control signal and Power fail signal output connector.
- ⑦ FG : Function Ground terminal (Frame ground)
- ⑧ L1,L2,L3 : Three phase AC input terminal (Fuse in each line)

• All specifications are subject to change without notice.

2 CN01, CN02 Connector pin configuration and function

CN01, CN02 pin configuration and function are the same.

They are connected to each other in this power supply unit.

When the pin of CN01 side is shorted the same function pins of CN02 side are shorted.

Please note that the function cannot be separately set with CN01 and CN02.

Pin No.	Configuration	Function
1	+V	Connected to +Output terminal in this Power supply unit. (+V terminal can not supply load current.)
2	+S	Remote sensing terminal for + output (For remote sensing function, which compensates for line drop between power supply terminals and load terminals. Connect to +V terminal when remote sensing function is unnecessary)
3	-V	Connected to -Output terminal in this Power supply unit. (-V terminal can not supply load current)
4	-S	Remote sensing terminal for - output (For remote sensing function, which compensates for line drop between power supply terminals and load terminals. Connect to -V terminal when remote sensing function is unnecessary)
5	PC	Current balance terminal (For output current balancing in parallel operation.)
6	COM	Ground for PC and PV signal.
7	PV	Output voltage external control terminal (For power supply output voltage control with an external voltage. Connect it with the terminal REF when PV function is unnecessary.)
8	REF	Reference Voltage terminal for Output voltage control (REF and PV are connected when shipping.)
9	CNT	Remote ON/OFF control terminal (When the CNT is pulled to TTL low, the power supply turns on.)
10	TOG	Ground for CNT and PF signal.
11	PF	Power fail signal output terminal. (As the output voltage drops, FAN stops and AC input voltage down, open collector output, "Power Fail" signal will output "High" .)
12	TOG	Ground for CNT and PF signal.

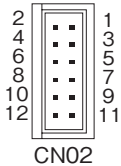
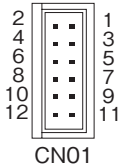

CN01, CN02 are connected in this power supply unit as follows.

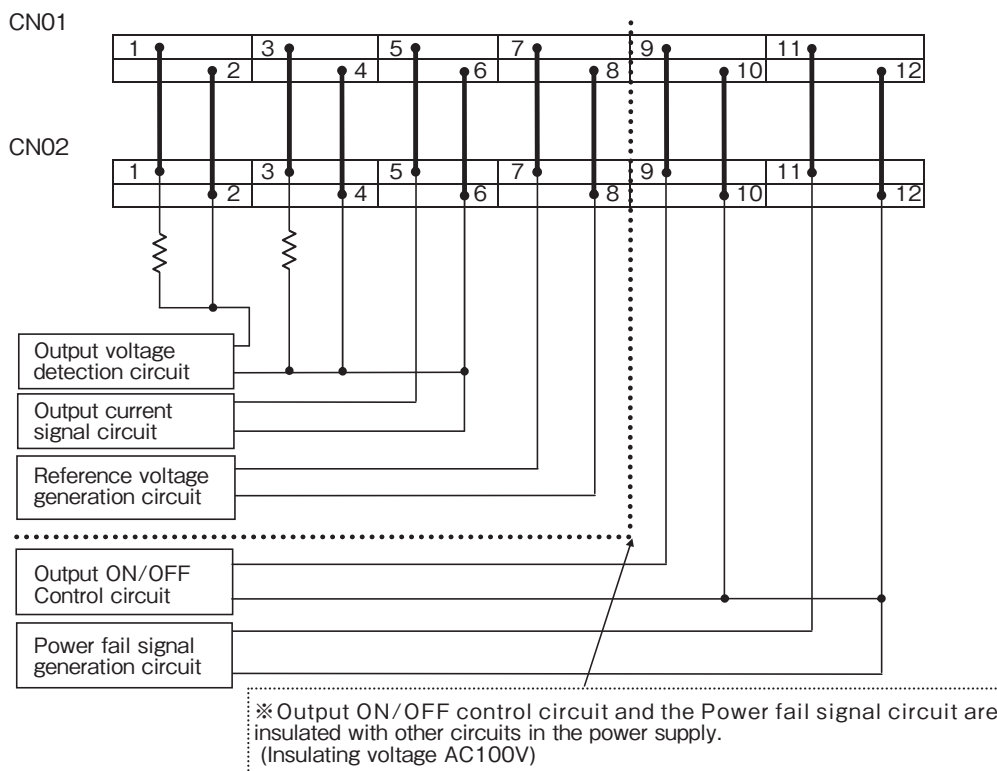

※ Output ON/OFF control circuit and the Power fail signal circuit are insulated with other circuits in the power supply. (Insulating voltage AC100V)

3 Basic Connection (Local sensing)

• 3-7V model

- ① Connect "+S" terminal to "+" terminal of output and "-S" terminal to "-" terminal of output with sensing wires.
 - ② Connect "CNT" terminal to "TOG" terminal with wire.
 - ③ Connect "PV" terminal to "REF" terminal with wire.
- ※ Please use attachment connector for each connection.
 ※ In the following cases, the output is shut down.
 When CNT and TOG is opened.
 When PV and REF is opened.

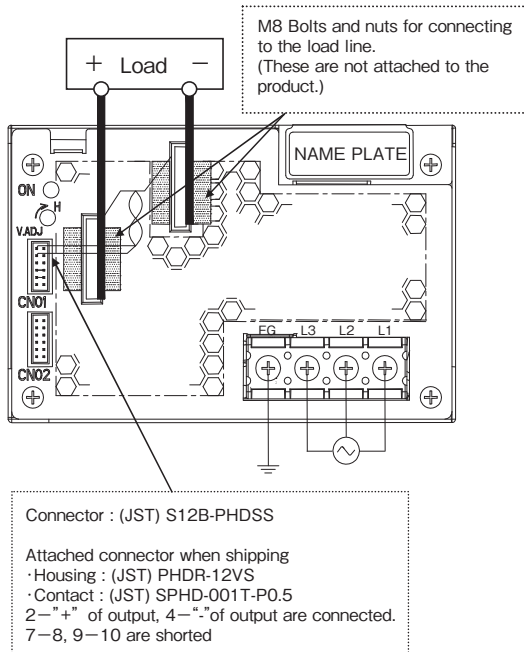

Attached connector when shipping

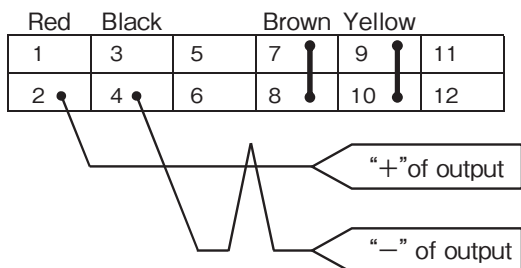

• 12-60V model

- ① Connect "+S" terminal to "+V" terminal and "-S" terminal to "-V" terminal with sensing wires.
 - ② Connect "CNT" terminal to "TOG" terminal with wire.
 - ③ Connect "PV" terminal to "REF" terminal with wire.
- ※ Please use attachment connector for each connection.
 ※ In the following cases, the output is shut down.
 When CNT and TOG is opened.
 When PV and REF is opened.

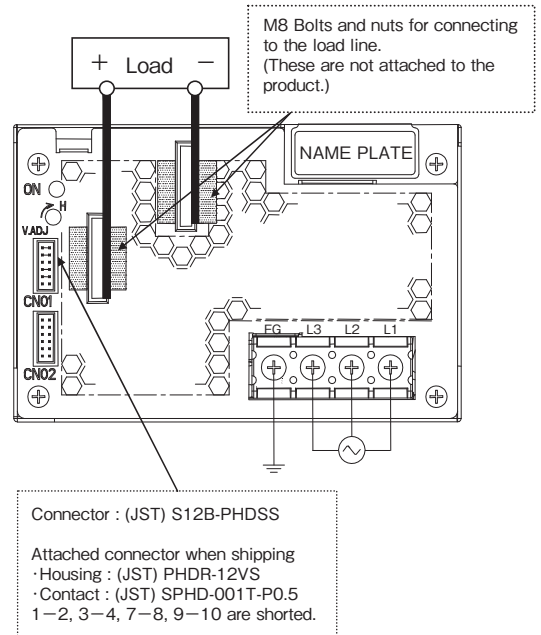

Attached connector when shipping

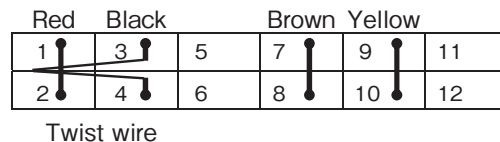

4 Remote sensing required

- ① Connect "+S" terminal to "+" terminal of load with sensing wire
 - ② Connect "-S" terminal to "-" terminal of load with sensing wires.
 - ③ Connect "CNT" terminal to "TOG" terminal with wire.
 - ④ Connect "PV" terminal to "REF" terminal with wire.
- ※ The accuracy of the output voltage will deteriorate when the sensing terminals are opened.
 ※ In the following cases, the output is shut down.
 When CNT and TOG is opened.
 When PV and REF is opened.

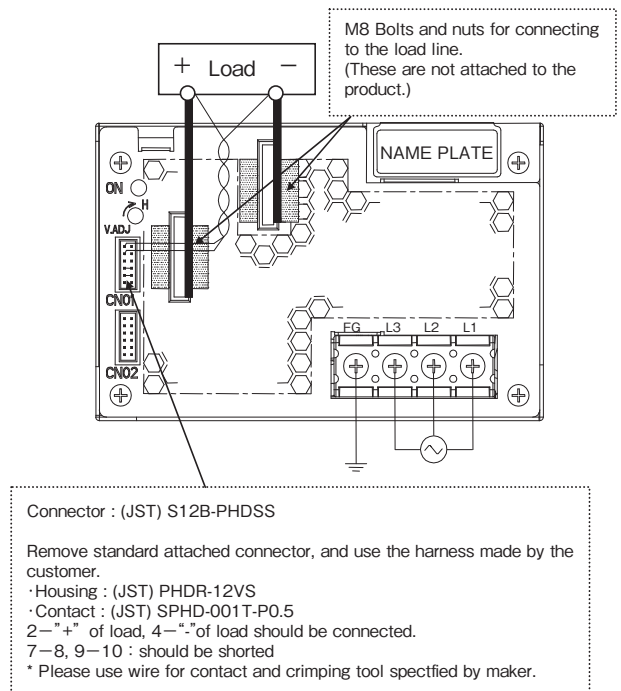

Connecting circuit with CN01 or CN02 connector

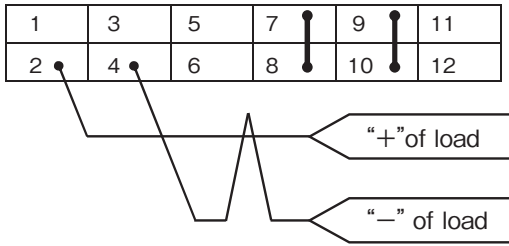

5 Remote ON/OFF control required

- ① Remove standard attached connector, and use the harness made by the customer and connect external signal to between CNT and TOG terminal.
- ② "TOG" terminal is ground for "CNT" terminal.
In case this function is not used, please short between CNT and TOG terminal.

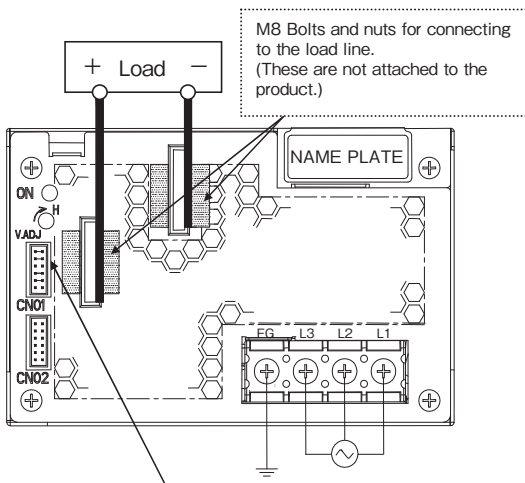

Connector : (JST) S12B-PHDSS

Remove standard attached connector, and use the harness made by the customer.

- Housing : (JST) PHDR-12VS
- Contact : (JST) SPHD-001T-P0.5

(3-7V model) 2- "+" of output, 4- "-" of output : should be connected
(12-60V model) 1-2, 3-4 : should be shorted
7-8 : should be shorted

9 : CNT
Should be connected to ON/OFF control signal.

10 : TOG
Should be connected to Signal Ground.

* Please use wire for contact and crimping tool specified by maker.

Connecting circuit with CN01 or CN02 connector

(3-7V model)

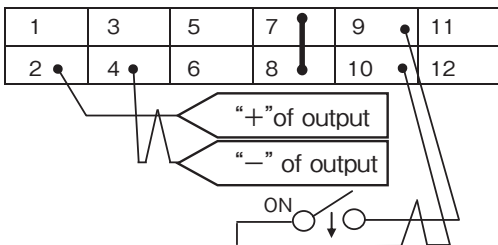

(12-60V model)

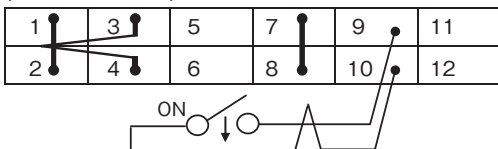

6 PF signal output required

- ① PF signal is an open collector output, therefore PF signal outputs is shown in circuit below.
- ② "TOG" terminal is ground for "PF" terminal.

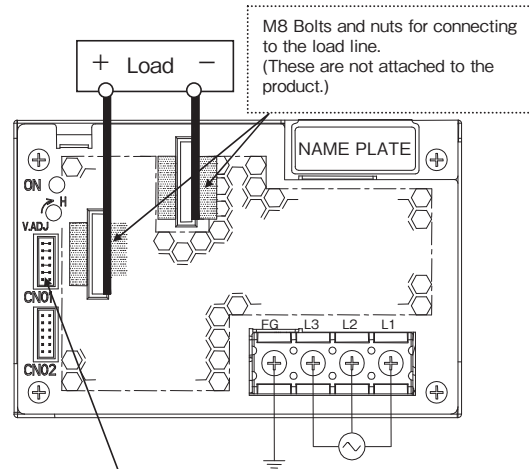

Connector : (JST) S12B-PHDSS

Remove standard attached connector, and use the harness made by the customer.

- Housing : (JST) PHDR-12VS
- Contact : (JST) SPHD-001T-P0.5

(3-7V model) 2- "+" of output, 4- "-" of output : should be connected
(12-60V model) 1-2, 3-4 : should be shorted
7-8, 9-10 : should be shorted

11 : PF
Should be connected to PF signal output

12 : TOG
Should be connected to Signal Ground.

* Please use wire for contact and crimping tool specified by maker.

Connecting circuit with CN01 or CN02 connector (3-7V model)

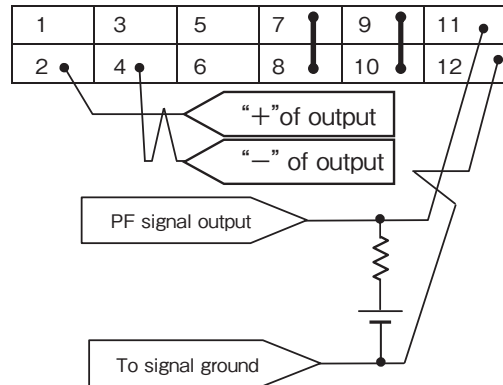

(12-60V model)

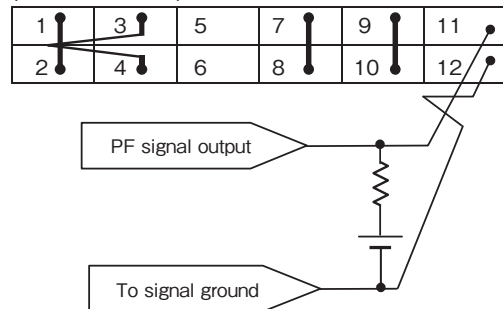

2. Functions and Precautions

1 Input Voltage Range

Input voltage range is three phase 170–265VAC(47–63Hz). Input voltage, which is out of specification, may cause unit damage. Rated input voltage range fix during safety standard application is from 200V to 240VAC (50/60Hz).

2 Output Voltage Range

Output voltage is set to the rated value at shipping. V.ADJ trimmer on the front panel side is use to adjust the output voltage within the range specified. Output voltage trimming range is within -20% – +20% of the rated output voltage (48V, 60V model: -20% – +10%). Turn the trimmer clockwise to increase output voltage. Take note when the output voltage is increased excessively over voltage protection (OVP) function may trigger and output voltage will shut down.

Use the output power of the power supply below the rated output power value when you raise the output voltage.

3 Over Voltage Protection (OVP)

The OVP function (Inverter shut down method, manual reset type) is provided. OVP function operates within 125-145% of the rated DC output voltage value (3-7V model: 125-140%, 36V model: 125-138%, 48V, 60V model: 115-125%), and the output will be shut down when OVP function triggers. When OVP function operates, the input power is cut off for a few minutes, and then power is re-input or remote ON/OFF control signal shall be input for recovery of the output. OVP value is fixed and can not be adjusted.

4 Over Current Protection (OCP)

The OCP function (Constant current limiting, Time delay shutdown type) is provided. OCP function operates when the output current exceeds 105% of maximum DC output current specification and the over current or short circuit condition continues 5-second or more, the output will be shut down. When the OCP is triggered, the input power is cut off for a few minutes, and then power is re-input or remote ON/OFF control signal should be input for recovery of the output. The OCP setting is fixed and not to be adjusted externally.

5 Over Temperature Protection (OTP)

Over temperature protection function (manual reset type) is provided. When ambient or internal temperature rises abnormally, OTP will shut down the output. When OTP is triggered, input power is cut off and allow sufficient cooling to reset the OTP function. Then power is re-input or remote ON/OFF control signal should be input for recovery of the output.

6 Low Output Detection Circuit (PF)

Low output voltage detection circuit is provided. Power Fail signal (PF signal) will output when output voltage decrease by either the drop or brown out of the input voltage or OCP, OVP and OTP function operation. PF signal will turn "High" level to indicate the abnormal status

of the power supply when the output voltage decrease to 80% of the output voltage setting value. However, there is a possibility that PF signal may not output during parallel operation. The PF signal circuit is insulated from the power supply input and output circuit and it is an open collector. TOG terminal is ground for PF terminal.

When the Built-in Fan Motor of this power supply unit stops, PF signal will turn to "H" and the output power will shut down. The Built-in Fan Motor is a component with lifetime. We recommend a periodic replacement. Please contact our sales office. Replacement is at customer's expenses.

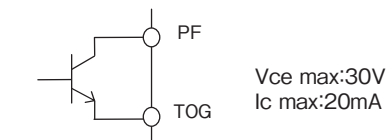

7 Remote Sensing (+S, -S terminal)

Remote sensing function is provided to compensate for voltage drop across the wiring from the power supply output terminals to the load input terminals. Connect "+S" terminal to "+" terminal of the load and "-S" terminal to "-" terminal of the load with sensing wires. The total line voltage drop (+ side line and - side line) shall be less than 0.3V. In case that sensing line is too long, it is necessary to put an electrolytic capacitor across the load terminals.

Please take note that the electrolytic capacitor has generation of heat etc. done by the ripple current depending on connected load. Therefore, the electrolytic capacitor must have a ripple current allowance higher than the output ripple current. If CN01 (or CN02) is in use, terminal +S, -S for CN02 (or CN01) must be in open condition.

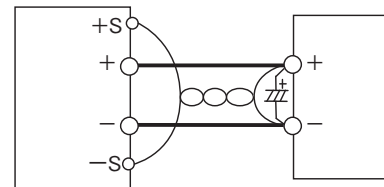

When the function of remote sensing is not in used, connect +S terminal to +V terminal, and -S terminal to -V terminal by the attachment connector.

If remote sensing terminals are opened, the stability and the accuracy of the output deteriorate. Therefore, terminal +S, -S must be connected.

8 Remote ON/OFF Control

Remote ON/OFF control is provided. Output can be remotely switch ON and OFF by using CNT terminal and TOG terminal even though input is connected. The output is turned to ON when TOG and CNT terminals are shorted and output is turned to OFF when these terminals are opened. When the function is not used, connect TOG and CNT terminals with short piece. The standards for this function are as follows. "TOG" terminal is ground for "CNT" terminal.

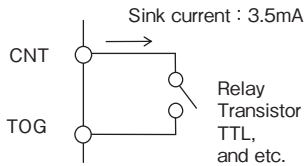

The Mode of control

CNT Level for TOG Terminal	Output	Built-in Fan Motor
Short or L (0-0.8V)	ON	Rotate
Open or H (2.4-12V)	OFF	Stop

- 1) TTL compatible. The maximum input voltage to CNT terminal is 12V, and the maximum allowable reverse voltage is -1V. The sink current of CNT terminal is 3.5mA.
- 2) Output ON/OFF control can be enable by a switch, relay or a transistor ON/OFF. When CNT terminal-TOG terminal is shorted power supply is turn ON, and when CNT terminal-TOG terminal is opened power supply is turn OFF.
- 3) Remote ON/OFF control circuit is isolated from the input and output circuit of power supply.

It is possible to use it regardless of the positive and negative of the power supply output.

Please be aware that if CNT terminal and TOG terminal is short and input voltage is gradually increase, this will trigger the low output voltage detector protection circuit and will result to output voltage shut down.

When the low output voltage detector protection circuit is triggered, the input power is cut off for a few minutes, and then power is re-input or remote ON/OFF control signal should be input for recovery of the output.

9 Output Ripple & Noise

Maximum ripple & noise value in specifications is measured according to measurement circuit specified by JEITA-RC9131A. When Load lines are longer, ripple & noise becomes larger. In this case, electrolytic capacitor, film capacitor, etc. might be necessary to use across the load terminal. The output ripple & noise cannot be measured accurately if the probe ground lead of oscilloscope is too long.

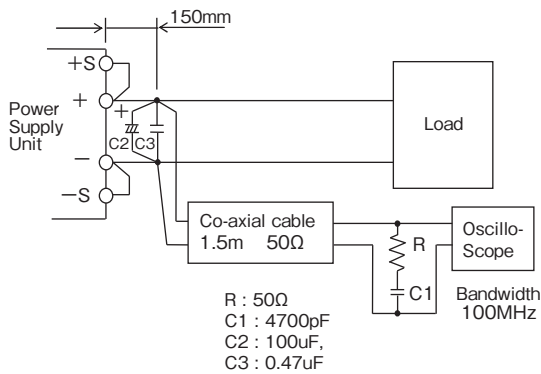

10 Series Operation

For series operation, either method (A) or (B) is possible. There might be a step in the rise waveform during series operation.

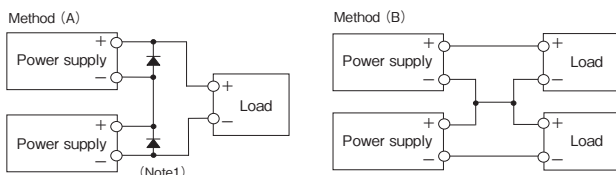

(Note1) Please connect a diode for by-pass when using method (A) of the series operation. Please use the diode with rated forward current is equal or more than load current and that the rated maximum reverse voltage is higher than output voltage for each power supply.

11 Parallel Operation

Current balancing function is provided. Either of operations mode (A) or (B) is possible.

(A) To Increase the Output Current

Current balancing function activates by connecting PC-to-PC terminal and COM-to-COM terminal, and output current of each power supply is equivalently supplied to load. Wires to PC terminals shall be as short as possible, same length and twisted. There is a possibility that output could be unstable caused by external noise. For this case, disconnect COM terminal and connect -S terminal from parallel power supply to a single point on the load. Please refer connection Method (A)-2.

- 1) Adjust the output voltage of each power supply to be same value within 1% or 100mV, whichever is smaller.
- 2) Use same length and type of wires for all load lines.
- 3) Maximum value of output current in parallel is up to 80% of all paralleled models. The purpose of the current balancing function is the static power-up. Therefore the output voltage might decrease according to the condition of dynamic load. There might be a step in the rise waveform during parallel operation.
- 4) Up to 5 units can be connected in parallel.

(B) To Use as a Backup Power Supply

- 1) Set power supply output voltage higher by the forward voltage drop of diode.
- 2) Adjust the output voltage of each power supply to be same value.
- 3) Use within the specifications for output voltage and output power.

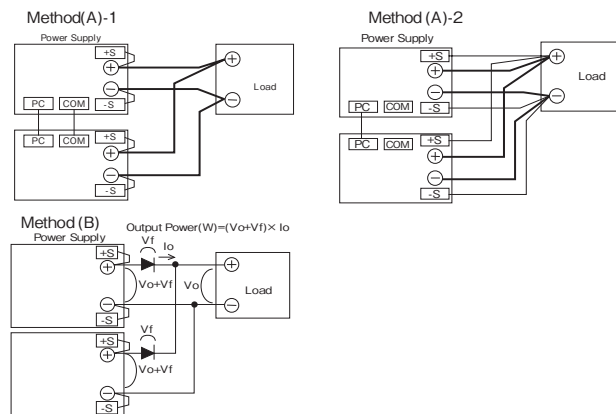

12 Isolation Test

Isolation resistance between output and FG (chassis) shall be more than 100Ω at 500VDC and between output and CNT·PF shall be more than 10MΩ at 100VDC. For safety operation, voltage setting of DC isolation tester must be done before the test. Ensure that it is fully discharged after the test.

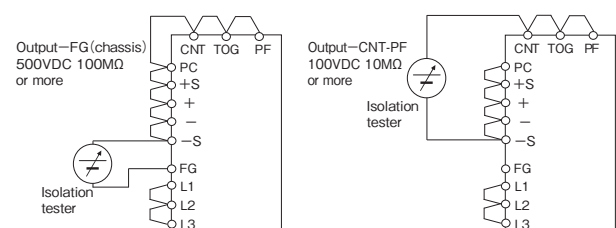

• All specifications are subject to change without notice.

13 Withstand Voltage

This series is designed to withstand 3.0kVAC between input and output, 2.0kVAC between input and FG (chassis), 500VAC (60V model: 651VAC) between output and FG (chassis), and 100VAC between output and CNT·PF terminal each for 1 minute. When testing withstand voltage, set current limit of withstand voltage test equipment at 20mA.

(Output-FG (chassis): 300mA (60V model: 390mA), Output- CNT·PF : 100mA).

The applied voltage must be gradually increased from zero to testing value and then gradually decreased for shut down. When timer is used, the power supply may be damaged by high impulse voltage at timer switch on and off. Connect input and output as follows. If output is left open during test, output voltage might appear momentarily.

This product have monolithic ceramic capacitor in secondary circuit to frame ground.

Some of the withstand voltage tester may generate high voltage at the matching with monolithic ceramic capacitor and may cause the unit damage.

So, please check the waveform of test voltage.

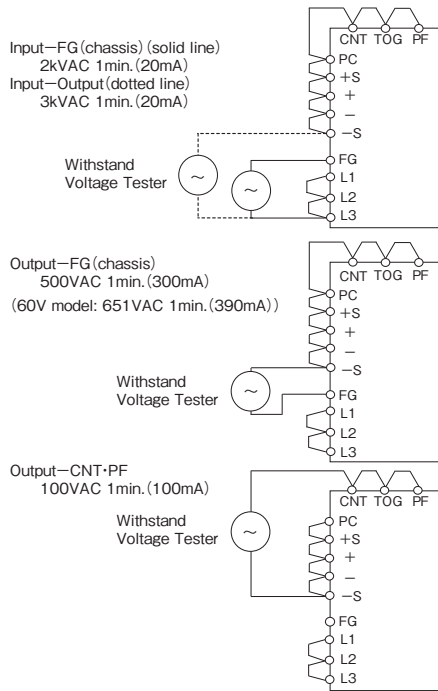

14 Output Voltage External Control (PV)

(A) Control by External Voltage

Output voltage external control function is provided. Output voltage can be varied by applying an external voltage (1-6V) to "PV" terminal and "COM" terminal. Note if an external voltage is not applied, there will be no output. Please consider the following characteristics below when operating the unit.

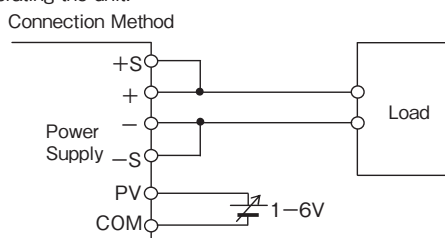

Output Voltage Linearity

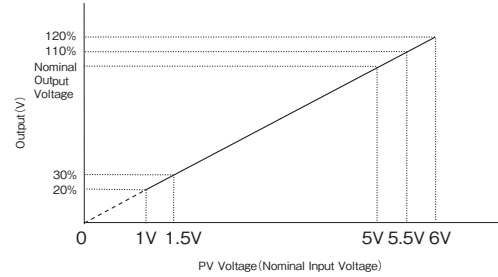

Note: Only as for the model of 3V output, the output voltage is used from 30% to 120% at the PV voltage is from 1.5V to 6V

Note: Only as for the model of 5-36V output, the output voltage is used from 20% to 120% at the PV voltage is from 1V to 6V

Note: Only as for the model of 48V, 60V output, the output voltage is used from 20% to 110% at the PV voltage is from 1V to 5.5V

Output Voltage Derating

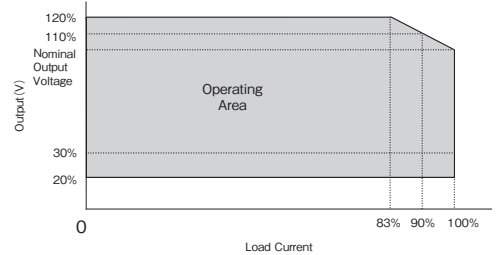

Note: Only as for the model of 48V, 60V output, the maximum output voltage is used up to 110% at 90% load current.

(B) Control by External Variable Resistor

"PV" terminal and "COM" terminal usage is the same as explained in section [control by external voltage] . But in this method voltage for control is supplied through REF terminal. Variable resistor is connected between REF terminal and COM terminal and the middle point of variable resistor is connected to PV terminal. Please use the output voltage within 20% - 120% of rated output voltage value (48V, 60V model: 20% - 110%). Wires for control lines must be twisted wire or shield wire. In addition, maximum variable voltage when control by external variable resistor is rated output voltage (100%). When output voltage must be externally control to 120% of rated output voltage (110% for 48V, 60V model), please follow the following procedure.

- (1) PV terminal and REF terminal is short by using standard connector supplied.
- (2) Set the power supply output voltage to maximum value of the output voltage variable range mentioned in specification standard by adjusting V.ADJ volume at the front panel.
- (3) Remove standard connector after input is cut off.
- (4) Connect external variable resistor (50kΩ) between REF terminal and COM terminal. Then connect middle point of external variable resistor to PV terminal.(sensing current is 1.4mA)

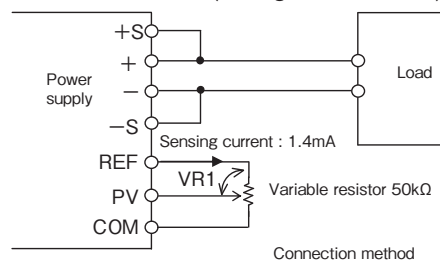

When output voltage is over rated value, please make sure that maximum output power is below rated value. Moreover, when output voltage is below rated value, please make sure that maximum output current is below rated value.

Please consider the following characteristic during usage.

Please consider the following characteristic during usage.

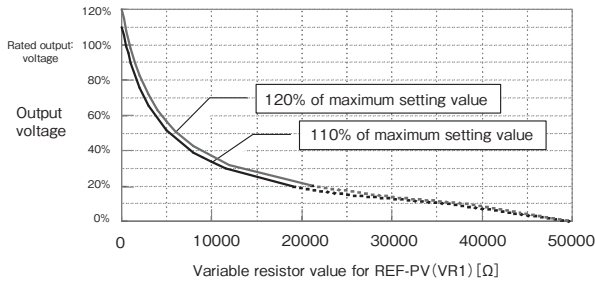

* Adjustable output voltage within 20% (3Vmodel : 30%) of output (less than 1V of PV voltage) is proportional to PV voltage and has a linear characteristic. However, for output voltage within 10% of output (about less than 0.5V of PV voltage), output will go into intermittent mode and ripple voltage becomes large, also irregular sound is release from the power supply. However, it is not damage. There will also be cases of the power supply shutting down triggered by under voltage lock out protection function. With output shutting down, low output detection function (PF) triggers the PF signal and set it to "H", and also output LED is switch off. Under voltage lock out protection mode, switch off input for a few minutes and then switch on input again for recovery. Recovery from under voltage lock out is also possible by turning remote ON/OFF control signal OFF and ON. Under voltage detection value uses an automatic tracking mode, which follows the output voltage and constantly correspond to the 70% -80% of output voltage with a protection function mode. Base on the explanation above, we will kindly exclude the usage of adjustable output voltage within 20% of the output voltage from the product warranty. For application that requires variable output voltage within 20% of output voltage, please kindly consider the above contents prior to operation. For application that requires output voltage below 20% , due to different type of application for the user's system, there might be a situation (behavior) different from the one mentioned above. Therefore please check with the user system.

15 Output Peak Current

For model with output peak current, please meet the following condition.

Reduce peak current value according to output derating as section 4-1.

The output is shut down by protection circuit when rated current and continuous peak output time (τ) exceeds rated value during usage.

When protection circuit is activated, input is temporarily cut off for a few minutes and then power is re-input or remote ON/OFF control signal should be input for recovery of the output.

Continuous Peak output time. (τ) : Within 10 seconds

Peak output current (Ip) : Within the rated peak output current

Duty : up to 35%

$$\text{Duty} = \frac{\tau}{T} \times 100 (\%)$$

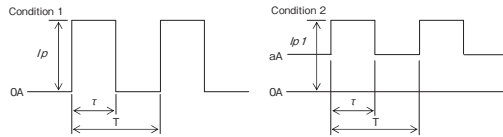

$$\sqrt{Ip^2 \times \frac{\tau}{T}} \leq I_{rms \max}$$

$$\sqrt{Ip1^2 \times \frac{\tau}{T} + a^2 \times (1 - \frac{\tau}{T})} \leq I_{rms \max}$$

Model	I _{rms max}
HWS1800T-6	177.5A
HWS1800T-7	142.0A
HWS1800T-12	88.7A
HWS1800T-15	71.0A
HWS1800T-24	62.1A
HWS1800T-36	41.4A
HWS1800T-48	31.0A
HWS1800T-60	24.8A

- Ip, Ip1 : Peak output current (A)
- I_{av} : Rated output current (A)
- I_m : Average output current (A)
- τ : Peak current pulse width (sec)
- T : cycle (sec)

16 Input Open Phase Detection

If one of the 3-phase input line becomes open or one phase voltage falls below 160VAC, the output will be shut off in approximately 3 seconds. To restore the output to normal, shut off the input once, and apply a normal input line voltage again after for a while.

3. Mounting Directions

1 Output Derating

Mounting directions are as follows.

Standard mounting method is (A). Methods (B), (C) and (D) are also possible.

Mounting methods besides (A),(B),(C) and (D) (example : (E) and (F)) are inhibit.

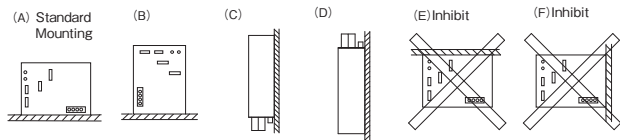

HWS1800T 3V Output Derating

Ta (°C)	LOAD (W)			
	A	B	C	D
-10 - +40	990	990	990	990
50	825	825	825	825
60	660	660	660	660
71	495	495	495	495

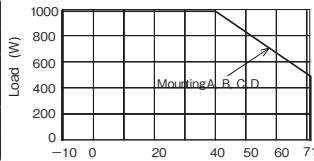

HWS1800T 5V Output Derating

Ta (°C)	LOAD (W)			
	A	B	C	D
-10 - +40	1500	1500	1500	1500
50	1250	1250	1250	1250
60	1000	1000	1000	1000
71	750	750	750	750

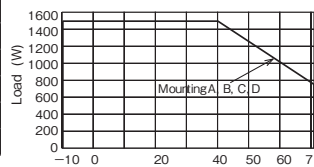

HWS1800T 6V-15V Output Derating

Ta (°C)	LOAD (W)			
	A	B	C	D
-10 - +40	1500	1500	1500	1500
50	1500	1500	1500	1500
60	1125	1125	1125	1125
71	750	750	750	750

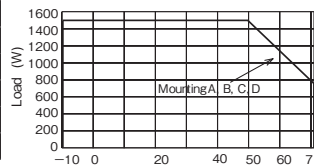

HWS1800T 24V-60V Output Derating

Ta (°C)	LOAD (W)			
	A	B	C	D
-10 - +40	1800	1800	1800	1800
50	1680	1680	1680	1680
60	1300	1300	1300	1300
71	900	900	900	900

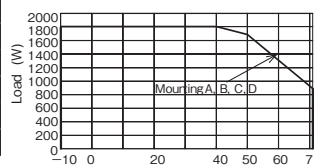

2 Mounting Method Caution

- (1) This Power supply unit is a forced air-cooling system with a built-in fan.
- (2) This power supply has ventilating holes on the front and back panels. Keep these areas freely more than 100mm from front side and more than 50mm from rear side.
- (3) Please note that ventilation will be worsened in a dusty environment.
- (4) Built-in fan is limited life part, which require periodic replacement. (Replacement will be charge).
- (5) The ambient temperature of this power supply is less than 50mm from the center of a front side.
- (6) The maximum allowable penetration of mounting screw is 6mm.
- (7) Recommended torque for mounting screw (M4) is 1.27N · m.

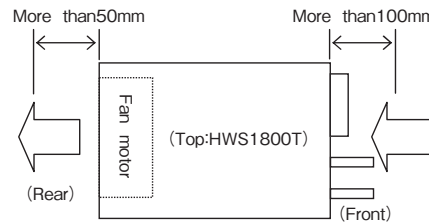

4. Wiring Method

- (1) The output load line and input line shall be separated and twisted to improve noise sensitivity.
- (2) The sensing lines shall be twisted or shield wire and separated from the output lines.
- (3) Use all lines as thick and short as possible to make lower impedance. Wires are to be twisted or use shield wire to improve noise sensitivity.
- (4) Attaching a capacitor to the load terminals can eliminate noise.
- (5) FG terminal of this power supply is functional earthing. For safety purposes, connect protective earthing terminal to the mounting set ground terminal.
- (6) Recommended torque for the terminal piece:

Input terminal (M4 screw) : 1.27 N·m
 Output terminal (M8 Bolt & Nut) : 10.8N·m

(7) Recommended wiring

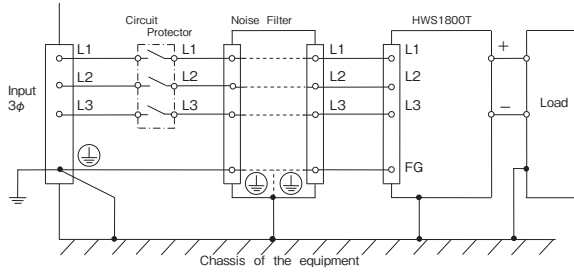

- (8) M4 screw for output terminal might damage the terminal's inner thread. This is mainly cause by the M4 screw's unthread section. Therefore, please select a washer, spring washer, etc. to avoid unthread screw section from penetrating into output terminal inner section.

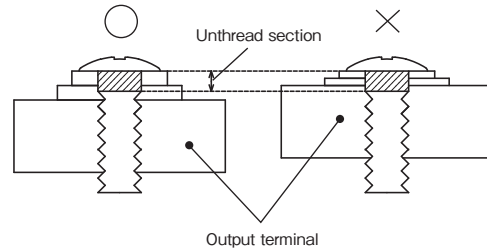

5. External Fuse Rating

Refer to the following fuse rating when selecting the external fuses for input line. Surge current flows when line turns on. Use slow-blow fuse or time-lag fuse. Do not use fast-blow fuse. Fuse rating is specified by in-rush current value at line turn-on. Do not select the fuse according to input

current (rms.) values under the actual load condition.
 HWS1800T : 20A

6. Troubleshooting

Before concluding that the unit is at fault, make the following checks.

- (1) Check if the rated input voltage is apply.
- (2) Check if the wiring of input and output is correct.
- (3) Check if the I/O terminal connection is properly tighten by a regulated tightening torque.
- (4) Check if the wire material is not too thin.
- (5) Check if the output voltage control (V.ADJ) is properly adjusted. OVP might be trigged and output is cut off.
- (6) Check if the wiring of "+S" and "-S" terminal is correct. If in open condition, the stability and the accuracy of the output deteriorate.
- (7) If use function of the remote ON/OFF control, check if the remote ON/OFF control connector is not opened. If in open condition, output is cut off.
- (8) Check if the built-in fan is not stopped. Is fan stopped by something irregulars or dust, etc. If fan stops, the PF signal is turn on. Moreover, the output is intercepted with the protection

circuit if fan stops.

Fans are the limited life parts.

- (9) This power supply has ventilating holes on the front and back panels. Check if there is any irregulars or dust, etc.
- (10) Is the main body of the power supply abnormally hot? Please turn on the input again after allowing the unit to cool down sufficiently. The output shut down by over temperature protection function.
- (11) Check if the output current and output power is not applied over specification.
- (12) Check if the input voltage wave is sinusoidal. If this power supply unit is connected to a UPS, input voltage wave might not be sinusoidal. An audible noise is emitted from the power supply unit.
- (13) Audible noise can be heard during Dynamic-Load operation.

7. Warranty

This product is warranted for a period of 5 years from the date of shipment. As for the breakdown under a normal use during free warranty term, repair is at free of charge. However, the Built-in Fan Motor replacement is for a fee. Please contact your nearest sales office for replacement. The Fan-life has limitation. Therefore, periodic maintenance by replacing the life-expired fan is required. The following figure shows the life of fan.

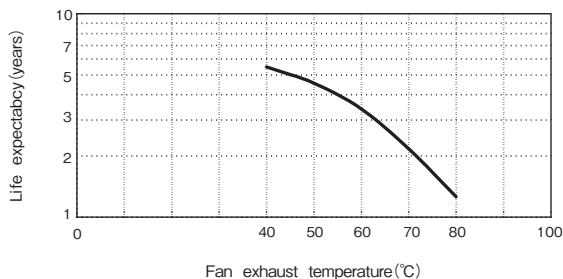

Life expectancy

Fan exhaust temperature	45°C	45,000 hour
Fan exhaust temperature	80°C	11,000 hour

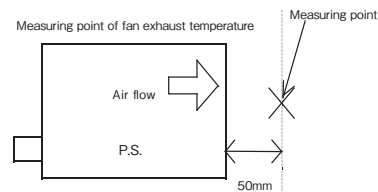

Conditions of usage at the free of charge warranty are as follows.

- (1) Average operating temperature (ambient temperature of the power supply unit) is 40°C
- (2) Average load factor is 80% or less
- (3) Installation method: Standard installation. However, the maximum rating is within the output derating.

Following cases are not covered by warranty.

- (1) Improper usage like dropping products, applying shock and defects from operation exceeding specification of the units.
- (2) Defects resulting from natural disaster (fire, flood).
- (3) Unauthorized modifications or repair by the buyers.
- (4) Defects not cause by TDK-Lambda.

8. Option

1 Fan unit for replacement

We have prepared an optional fan unit for replacement.

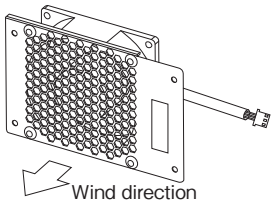
Name of fan unit for replacement	Applicable models	Appearance	Pin assignments	Price								
1500-FAN-01	HWS1000 HWS1500 HWS1800T (of standard specifications)		Housing = XHP-3(J.S.T.) Contact = SXH-001T-P0.6(J.S.T.) <table border="1" style="margin: 5px auto;"> <tr> <th>Pin No.</th> <th>Description</th> </tr> <tr> <td>1</td> <td>Power supply</td> </tr> <tr> <td>2</td> <td>Fan alarm</td> </tr> <tr> <td>3</td> <td>GND</td> </tr> </table> Length of fan harness = 65 ± 10mm	Pin No.	Description	1	Power supply	2	Fan alarm	3	GND	Open
Pin No.	Description											
1	Power supply											
2	Fan alarm											
3	GND											

Ask us for replacement of the fan. This will be a charged service. If you are replacing the fan by yourself, note the following.

- *1. Be careful in handling the fan unit so as not to cause an impact by dropping it or hitting it, etc.
- *2. Shut down the input before starting the replacement operation.
- *3. Check that there are no loose parts in connectors or harness tucking, etc.
- *4. Safety standards (UL, CE, etc.) are not applicable.

2 Insulation tube for HWS1800T

The following insulation tube can be used for output terminal.

•TCV-2001 (shinagawa shoko)

Please confirm shape and size from manufacturer catalog.

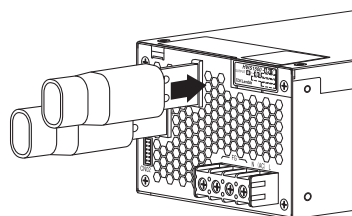

Example of use for insulation tube

HWS300P-600P Series Instruction Manual

BEFORE USING THE POWER SUPPLY UNIT

Be sure to read this instruction manual thoroughly before using this product. Pay attention to all cautions and warnings before using this product. Incorrect usage could lead to an electrical shock, damage to the unit or a fire hazard.

⚠ DANGER

- Never use this product in locations where flammable gas or ignitable substances are present

⚠ WARNING

- Do not touch this product or its internal components while it is in operation, or shortly after shut down. There may be high voltage or high temperature present and you may receive an electric shock or burn.
- When the product is operating, keep your hands and face away from it; an accident may injure you.
- Do not make unauthorised changes to this product, otherwise you may receive an electric shock and void your warranty.
- Do not use this product in the event of the emission of smoke or abnormal smell and sound etc. It might lead to fire and/or electric shock. In such cases, please contact us. Do not attempt repair by yourself, as it is dangerous for the user.
- Do not operate these products in the presence of condensation. It might lead to fire and/or electric shock.
- Do not drop or insert anything into the product. It might lead to a failure, fire and/or electric shock. Do not use the product which dropped.

⚠ CAUTION

- This power supply is designed for use within an end product.
- Confirm connections to input/output terminals and signal terminals are correct as indicated in the instruction manual before switching on.

- Input voltage, Output current, Output power, ambient temperature and ambient humidity should be kept within specifications, otherwise the product will be damaged.
- Do not operate and store this product in an environment where condensation might occur. In such case, waterproof treatment is necessary.
- Do not use this product in environment with a strong electromagnetic field, corrosive gas or conductive substances.
- For applications which require very high reliability (Nuclear related equipment, traffic control equipment, etc.) it is necessary to provide a fail safe mechanism in the end equipment.
- The information in this document is subject to change without prior notice. Please refer to the latest version of the data sheet, etc., for the most up-to date specifications of the product.
- No part of this document may be copied or reproduced in any form without prior written consent of TDK-Lambda.
- Do not inject abnormal voltages into the output or signal of this product. The injection of reverse voltage or over voltage exceeding nominal output voltage into the output or signal terminals might cause damage to internal components.
- The output of this product is considered to be a hazardous energy level (The voltage is 2V or more and the power is 240VA or more). It must not be made accessible to users. Protection must be provided for Service Engineers against indirect contact with the output terminals and/or to prevent tools being dropped across them. While working on this product, the AC input power must be switched off and the input and output voltage should be zero.
- This product has a built-in fan for air-cooling. Do not block the air intake and exhaust as this might lead to fire.

CE MARKING

- CE Marking when applied to a product covered by this handbook indicates compliance with the low voltage directive (2006/95/EC) in that it complies with EN60950-1.

1. Terminal Explanation

Please pay extra attention to the wiring. Incorrect connection will damage the power supply.

1 Front Panel Explanation

HWS300P

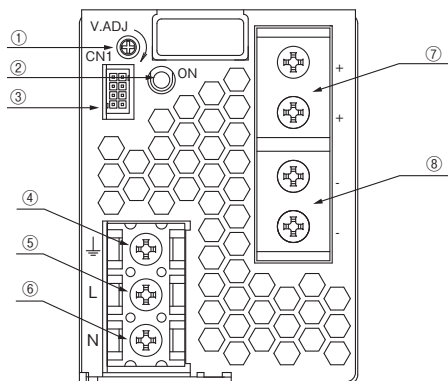

- ① V.ADJ : Output voltage adjustment trimmer.
(The output voltage rises when a trimmer is turned clockwise.)
- ② ON : Output (Power On) indication LED.
(The indicator turns on when the power supply output is in normal operating condition.)
- ③ CN1 : ON/OFF control signal, Current balance signal (only as for HWS600P), Power fail signal. (Refer to 2-2.)

HWS600P

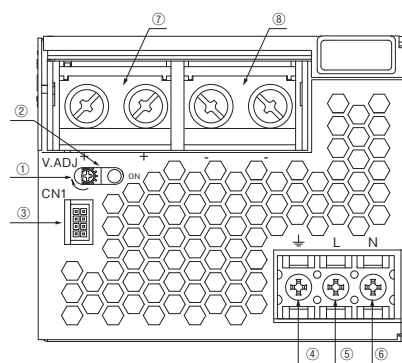

- ④ ⊥ : Protective Earth terminal (Frame ground), M4 screw.
- ⑤ AC input terminal L : Live Line (Fuse in line), M4 screw.
- ⑥ AC input terminal N : Neutral line, M4 screw.
- ⑦ + : + Output terminal (HWS300P: M4 screw x 2 / HWS600P: M5 screw x 2)
- ⑧ - : - Output terminal (HWS300P: M4 screw x 2 / HWS600P: M5 screw x 2)

2 CN1 Connector pin Configuration and Function

Pin No..	Configuration	Function
1	COM	GND for PC signals (Only as for HWS600P. HWS300P is NC.)
2	PC	Current balance terminal. (For output current balancing in parallel operation. Only as for HWS600P. HWS300P is NC.)
3	NC	No connect
4	NC	No connect
5	CNT	Remote ON/OFF control terminal.(Power supply ON/OFF control with an external signal.)
6	TOG	GND for CNT and PF signals. (Same as Pin No.8)
7	PF	Power fail signal (PF signal) output terminal. (Uses the open collector method. As the output voltage drops, or FAN stops, "Power Fail" terminal will output "High" .)
8	TOG	GND for CNT and PF signals. (Same as Pin No.6)

CN1 Connector & Housing & Terminal Pin

PART DESCRIPTION	PART NAME	MANUFACT
PIN HEADER	S8B-PHDSS	J.S.T.
SOCKET HOUSING	PHDR-08VS	J.S.T.
TERMINAL PINS	SPHD-002T-P0.5(AWG28 - 24)	J.S.T.
	SPHD-001T-P0.5(AWG26 - 22)	
HAND CRIMPING TOOL	YRS-620(SPHD-002T-P0.5)	J.S.T.
	YC-610R(SPHD-001T-P0.5)	

3. Terminal Connection Method

Please pay extra attention to the wiring. Incorrect connection will damage the power supply.

- When connecting input and output wiring, and CN1, input AC-Line should be off.
- Input wiring and output wiring shall be separated to improve noise sensibility.
- The protective earth (PE) must be connected to the terminal or chassis.
- Remote ON/OFF control lines shall be twisted or used shielded wires. Separate from load line.
- Output current of each terminal screw shall be less than 40A for HWS300P. And shall be less than 60A for HWS600P.

• ON/OFF control required

"TOG" terminal is ground for "CNT" terminal.

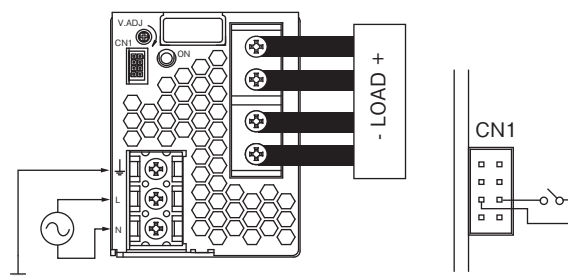

HWS300P Panel Side (Common HWS600P)

• Basic connection

Connect "CNT" terminal to "TOG" terminal with the attached connector.

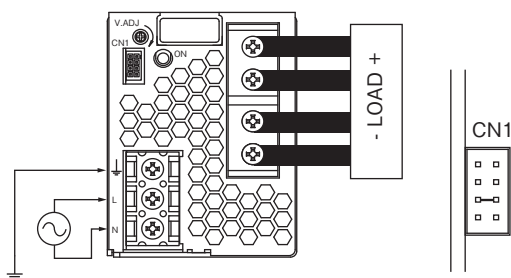

• PF signal output required

Open collector method shown below shall be used.
"TOG" terminal is ground for "PF" terminal.

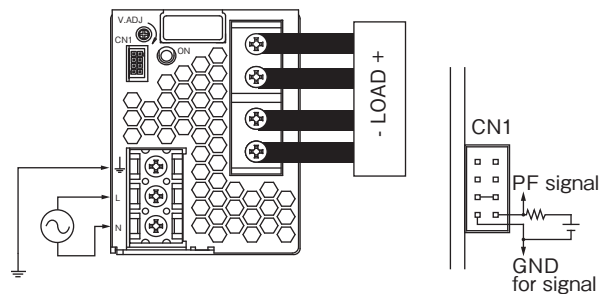

4. Functions and Precautions

1 Input Voltage Range

Input voltage range is single phase 85 - 265VAC (47 - 63Hz) or 120 - 330VDC. Input voltage, which is out of specification, may cause unit damage. Rated input voltage for safety standard application is 100 - 240VAC(50/60Hz).

2 Output Voltage Range

Output voltage is set to the rated voltage value at shipment. V.ADJ trimmer on the front panel side is used to adjust the output voltage within the range specified.

Output voltage range is within -20% - $+10\%$ of rated output voltage.

To turn the trimmer clockwise, the output voltage will be increased. Take note when the output voltage is increased excessively, over voltage protection (OVP) function may trigger and output voltage will be shut down.

When output voltage increased, average output power and peak output power have to use less than specification.

3 Over Voltage Protection (OVP)

The OVP function (Inverter shutdown method, manual reset type) is provided. OVP function operates within 115-135% of the rated output voltage value, and the output will be shut down when OVP function trigger. To reset OVP, remove the input of power supply for a few minutes, and then re-input. Or, use CNT reset (remote ON/OFF : OFF to ON). OVP value is fixed and not to be adjusted externally.

Never apply more than rated output voltage to output terminal, which may lead damage to power supply. In the case of inductive load, use decoupling diode at output line.

4 Delay Shut Down

This product have a delay shut down function provided to protect power supply and equipment at the time of the consecutive peak current. When the product operate peak current for more than 5 seconds, delay shut down function operates and the output will be shut down.

To reset delay shut down, remove the input of power supply for a few minutes, and then re-input. Or, use CNT reset (remote ON/OFF : OFF to ON).

Delay Shut Down Time value is fixed and not to be adjusted externally.

Use it about the peak electricity in specifications range. The details see at "4-14. Output Peak Power" .

5 Over Current Protection (OCP)

The OCP function (manual reset type) is provided. Output will be shut down in condition over current or output short-circuit.

To reset OCP, remove the input of power supply for a few minutes, and then re-input. Or, use CNT reset (remote ON/OFF : OFF to ON).

Also avoid over current condition or output short-circuit.

Otherwise the product will be damage.

OCP value is fixed and not to be adjusted externally.

6 Over Temperature Protection (OTP)

The OTP function (manual reset type) is provided. When ambient or internal temperature rises abnormally, OTP function operates and output will be shut down. After shut down, remove the input and cool it down to reset OTP. Then re-input.

Or, use CNT reset (remote ON/OFF : OFF to ON).

7 Low Output Detection Circuit (PF)

Low output voltage detection circuit is provided. Power Fail (PF) signal will turn "High" level to indicate the abnormal status when the output voltage becomes within 65 ~ 80% of rated value caused by either the drop or brownout of the input voltage or OCP, OVP, Delay Shut Down and OTP etc function operation. When the built-in FAN motor of this power supply unit stops, PF signal will turn to "H" . The PF signal is isolated from input and output by a photo-coupler. It uses the open collector method shown in below.

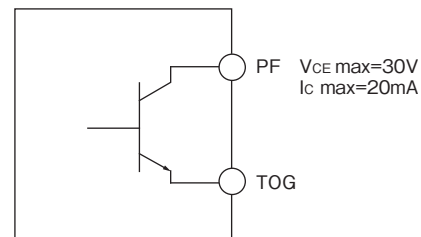

8 Remote ON/OFF Control

Remote ON/OFF control is provided.

Using this function, output on/off is allowed to control without input voltage on/off. The output is turned to ON when TOG and CNT terminals are shorted, and the output is turned to OFF when these terminals are opened. When the function is not used, connect TOG and CNT terminals. The standards for this function are as follows. "TOG" terminal is return for "CNT" terminal.

- (1) TTL compatible. The maximum input voltage to CNT terminal is 12V, and the maximum allowable reverse voltage is $-1.0V$. The sink current for CNT terminal is 3.5mA.
- (2) A switch and relay or a transistor can be used as ON/OFF switch.
- (3) Remote ON/OFF control circuit is isolated from the input and output by a photo-coupler and can be controlled regardless of the output potential (+ or -). Connect TOG terminal to ground of control signal.

The mode of control

CNT Level for TOG Terminal	Output	Built-in Fan
Short or L (0V - 0.8V)	ON	Rotate
Open or H (2.4V - 12V)	OFF	Stop

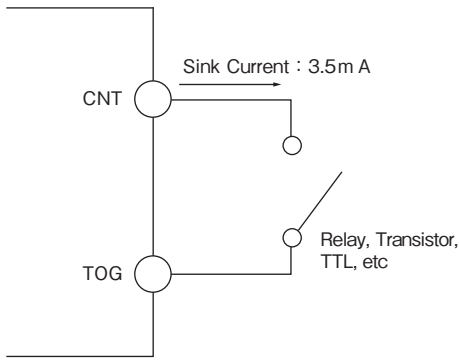

9 Output Ripple & Noise

The standard specification for maximum ripple value is measured specified measurement circuit (JEITA-RC9131A). When load lines are longer, ripple becomes larger. In this case, electrolytic capacitor, film capacitor, etc. might be necessary to use across the load terminal. The output ripple cannot be measure accurately if the probe ground lead of oscilloscope is too long.

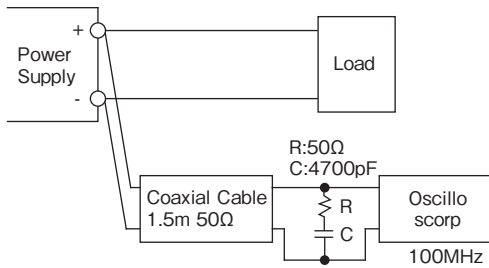

10 Series Operation

For series operation, both method (A) and (B) are possible. There might be a step in the output rise waveform during series operation.

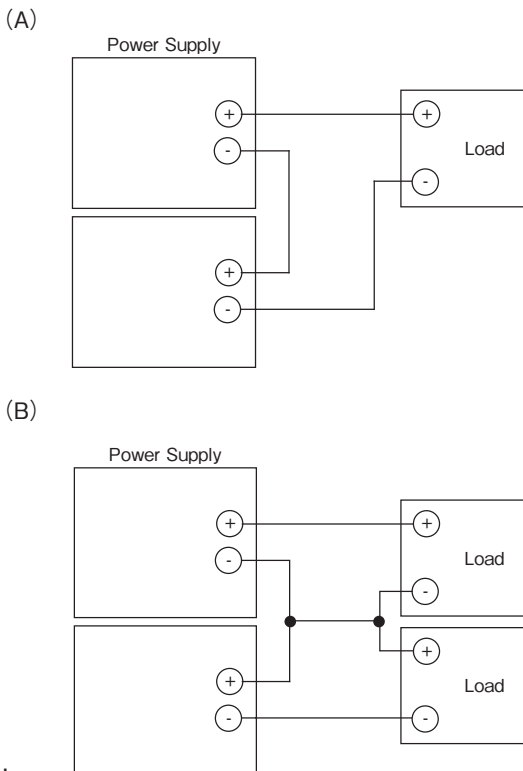

11 Parallel Operation

Both operations mode (A) and (B) are possible.

(A) To Increase the Output Current(only as for HWS600P)
Current balancing function is provided. Connecting PC to PC terminal and COM to COM terminal, the current balancing function activates and output current of each power supply is equivalently supplied to load. Wires to PC terminals, COM terminals shall be as short as possible and same length and twisted. Parallel operation is possible up to 2 units.

- 1) Adjust the output voltage of each power supply to be same value within 100mV.
- 2) Use same length and type of wires for all load lines.
- 3) Use the power supply within the rated output current for all paralleled models.

(B) To Use as a Backup Power Supply

- 1) Adjust the output voltage of each power supply to be same value.
- 2) Set power supply output voltage higher by the forward voltage drop of diode.
- 3) Use within the specifications for output voltage and output power.

Method (A) To Increase the Output Current
(only as for HWS600P)

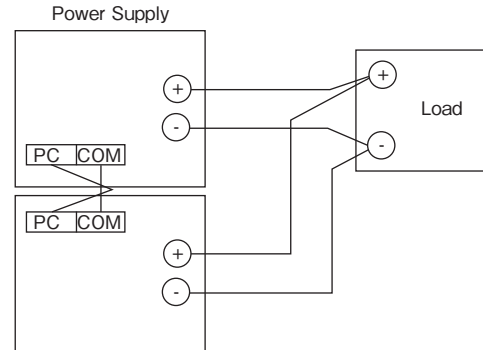

Method (B) To Use as a Backup Power Supply

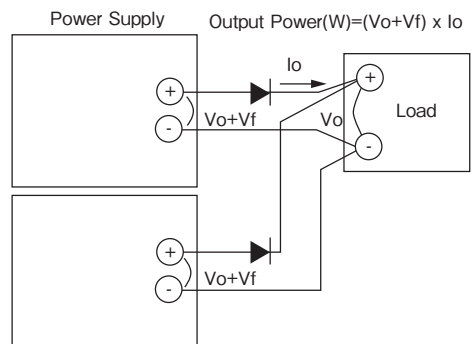

12 Isolation Test

Isolation resistance between output and \perp (chassis) shall be more than 100M Ω at 500VDC and between output and CNT·PF shall be more than 10M Ω at 100VDC. For safety operation, voltage setting of DC isolation tester must be done before the test. Ensure that it is fully discharged after the test.

Output - FG (chassis) : 500VDC 100M Ω or more

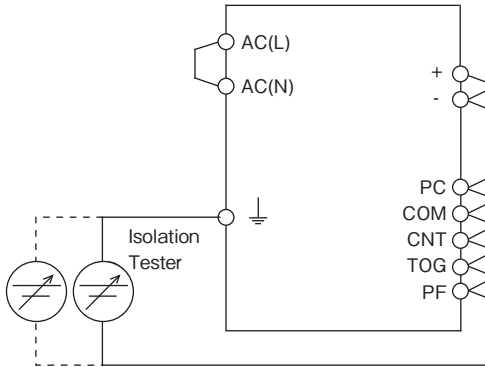

Output - CNT · PF : 100VDC 10M Ω or more

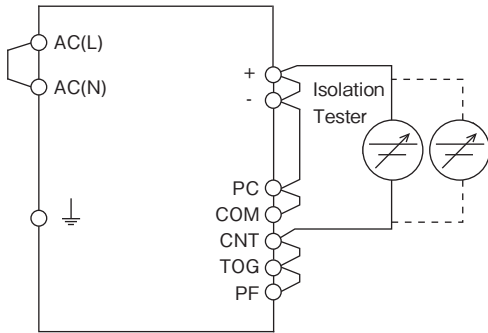

Note 1. "PC" and "COM" are NC in HWS300P.

13 Withstand Voltage

This series is designed to withstand 3.0kVAC between input and output, 2.5kVAC between input and \perp (chassis), 500VAC between output and \perp (chassis), and 100VAC between output and CNT·PF terminal each for 1 minute. When testing withstand voltage, set current limit of withstand voltage test equipment at 20mA.

(Output- (chassis) and Output-CNT·PF: 100mA).

The applied voltage must be gradually increased from zero to testing value and then gradually decreased for shut down. When timer is used, the power supply may be damaged by high impulse voltage at timer switch on and off. Connect input and output as follows.

In the test by state of output open, there is a thing that output voltage is generated momentarily.

Input - Output (dotted line) : 3.0kVAC 1min. (20mA)
 Input - \perp (chassis) (solid line) : 2.5kVAC 1min. (20mA)

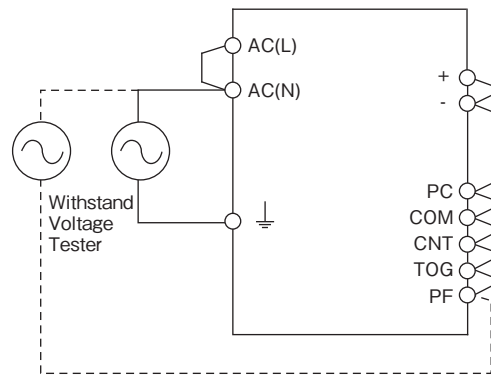

Output - \perp (chassis) : 500VAC 1min. (100mA)

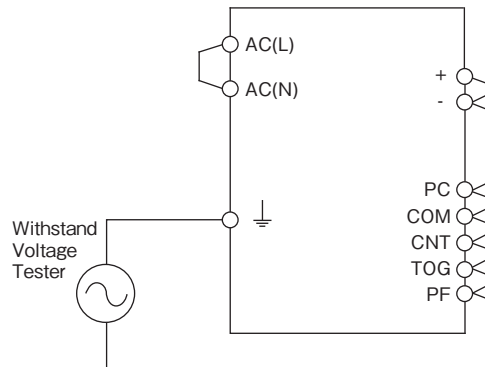

Output - CNT·PF : 100VAC 1min. (100mA)

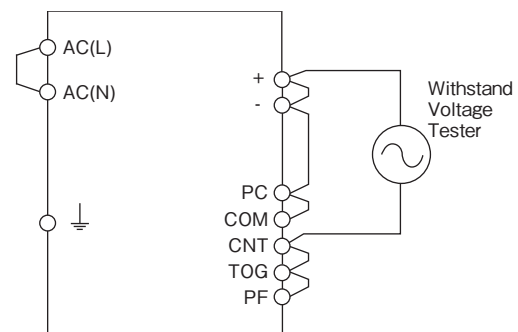

Note 1 "PC" and "COM" are NC in HWS300P.

Note 2 This product have monolithic ceramic capacitor in secondary circuit to frame ground.

Some of the withstand voltage tester may generate high voltage at the matching with monolithic ceramic capacitor and may cause the unit damage.
So, please check the waveform of test voltage.

14 Output Peak power

This product must be use to satisfy (a) and (b).
Allowable peak output operating time is less than 5sec.
When the product operate peak power for more than 5 sec, the delay shut down function operates and the output will shut down.
Peak output power and average output power use less than specification.
Peak output power is limited depending on Duty. The details see at (b).
The product might be damage to use beyond the limits of (a) and (b).
When using pulse load, a noise may be heard from power supply unit. Please evaluate and check before using.

(a) Expression of relations

A formula about Duty

$$\text{Duty} = \frac{\tau}{T} \times 100 (\%)$$

A formula about average output power

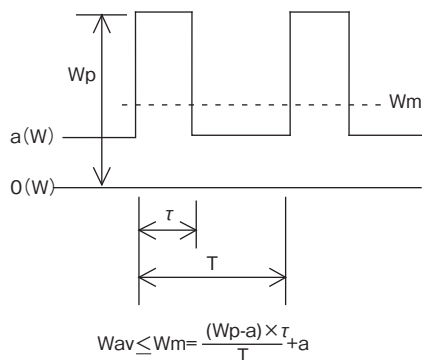
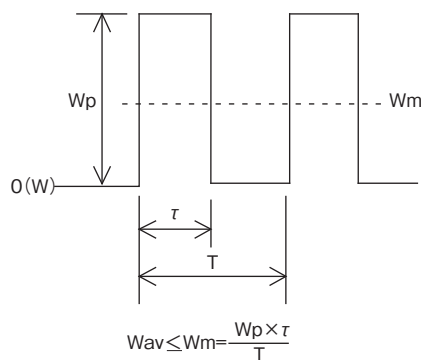

- Wp : Peak output power (W)
- Wav : Rated average output power(W)
(Average output power of Specification)
- Wm : Average output power (W)
- tau : Pulse width of peak output power (sec)
(Operating time at peak output)
- T : Period (sec)

(b) Peak output power VS Peak Duty

HWS300P

Vin:100VAC(dotted line)/Vin:200VAC(solid line)

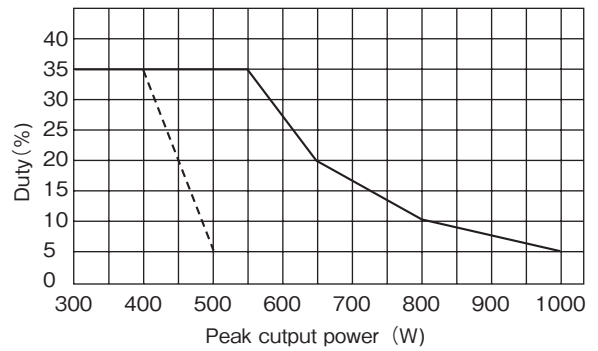

HWS600P

Vin:100VAC(dotted line)/Vin:200VAC(solid line)

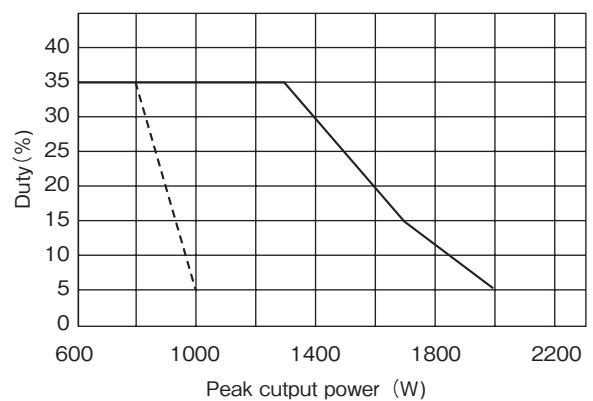

5. Mounting Directions

1 Output Derating according to the Mounting Directions.

Recommended standard mounting method is (A). Method (B) is also possible. Refer to the derating below.

HWS300P

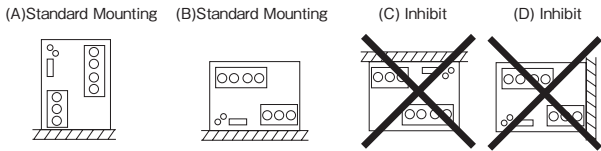

HWS600P

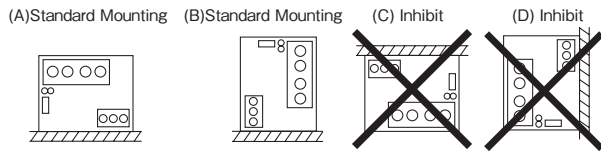

2 Output Derating

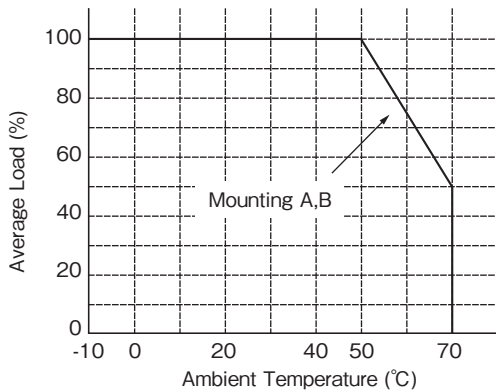

Ta(°C)	Average Load (%)	
	Mounting(A)	Mounting(B)
-10 ~ +50	100	
+70	50	

Note 1, Peak power does not have the derating.

3 Mounting Method

- Forced air-cooling type power supply.
This power supply has ventilating holes on the front and back side panels. Keep these two areas freely as much as possible.
- The maximum allowable penetration is 6mm.
Incomplete thread of mounting screw should not be penetrated.
- Recommended torque for mounting screw : M4 screw : 1.27 N · m (13.0kgf · cm)

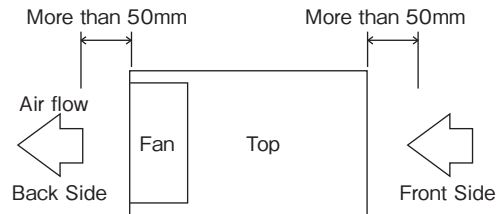

6. Wiring Method

- The output load line and input line shall be separated to improve noise sensitivity.
- Use all lines as thick and short as possible to make lower impedance.
- Attaching a capacitor to the load terminals can eliminate noise.
- For safety and EMI considerations, connect terminal to the mounting set ground terminal.
- Recommended torque for the terminal ;
HWS600P Output terminal (M5 screw)
: 2.50 N · m (25.5kgf · cm)
HWS300P Input, Output terminal & HWS600P Input terminal (M4 screw)
: 1.27 N · m (13.0kgf · cm)

[The PHD connector manufacture method]

This product is using SPHD-001T-P0.5 or SPHD-002T-P0.5 connector made from JAPAN SOLDERLESS TERMINAL MFG CO LTD.

Regarding to manufacture of a connector, it becomes the regulation as following.

a). Applicable Wire and Crimping tool

Wire size to use for SPHD-001T-P0.5 is AWG#26 ~ AWG#22 and insulation outer diameter is $\phi 1.0 \sim \phi 1.5$ mm. Wire size to use for SPHD-002T-P0.5 is AWG#28 ~ AWG#24 and insulation outer diameter is $\phi 0.9 \sim \phi 1.5$ mm. Crimping tool is as blow.

Crimping tool	Crimping applicator	Dies
AP-K2 or AP-KS	MKS-LS-10 or MKS-L-10	SPHD-001-05/SPHD-002-05

b). Crimping Operation

The reference value of wire strip is 2.3mm. As wire strip length differs depending on type of wire and crimping method, decide the best wire strip length considering processing condition. When wire is stripped, do not damage or cut off wire conductors.

Table of crimp height
SPHD-001T-P0.5

Wire Size	Insulation O.D (mm)	Crimp height (mm)	
		Conductor part	Conductor part
AWG#26	1.3	0.60 ~ 0.70	1.7
AWG#24	1.5	0.65 ~ 0.75	1.8
AWG#22	1.4	0.70 ~ 0.80	1.8

SPHD-002T-P0.5

Wire Size	Insulation O.D (mm)	Crimp height (mm)	
		Conductor part	Conductor part
AWG#28	1.2	0.55 ~ 0.60	1.6
AWG#26	1.3	0.60 ~ 0.65	1.7
AWG#24	1.5	0.62 ~ 0.67	1.8

- Note 1. Crimp height at wire barrel should be set to pre-determined dimensions.
- Note 2. Adjust crimp height at wire insulation barrel to the extent that wire insulation is slightly pressed, and set it so that crimping is not excessivary.
- Note 3. Crimping condition at wire insulation barrel is as below Fig.1.
- Note 4. For AWG#28,#26,#24, use UL1007 type. For AWG#22, use UL1061 type.



Good

Fig.1

Table of tensile strength at crimped part.
SPHD-001T-P0.5

Wire size	Requirement N min.	Actual value N
AWG#26	20	39.2 ~ 45.1
AWG#24	30	68.6 ~ 74.5
AWG#22	40	92.1 ~ 96.0

SPHD-002T-P0.5

Wire size	Requirement N min.	Actual value N
AWG#28	15	27.0 ~ 34.3
AWG#26	20	44.1 ~ 48.0
AWG#24	30	66.6 ~ 71.5

Fig.2: Examples of defective crimping

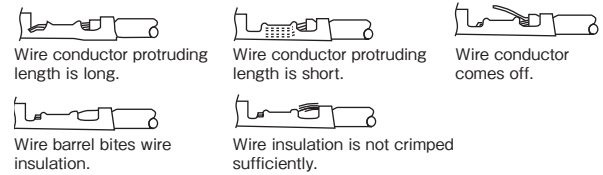

c). Inserting contact into housing

- (1) Do not apply any pulling force to crimped part, and insert contact parallel to housing.
- (2) Insert contact into housing without stopping to innermost.
- (3) Check secure locking per each insertion by pulling wire softly in order to check that contact does not come off housing. Besides, check whether there is the backlash in the direction of insertion axis.

Defect example of slating insertion

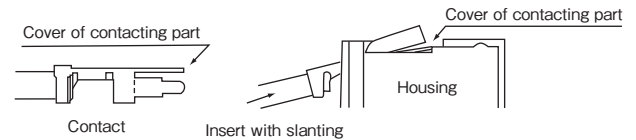

d). Mating and Unmating Connector

- (1) Inserting connector
Hold receptacle housing securely and insert into header straight against to header post until click sounds.
- (2) Unmating connector
Hold all wires securely and fix receptacle housing by fingers so as to pry, and then, withdraw it on the mating axis.

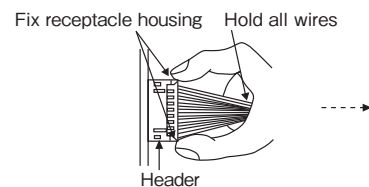

e). Routing of Wire

Routing wire so as not to apply external force to connector except force to such an extent that wire slightly buckles, considering an enough length to route and fixing of wire.

7. External Fuse Rating

Refer to the following fuse rating when selecting the external fuses that are to be used on input line. Surge current flows when line turns on. Use slow-blow or time-lag type fuse, not fast-blow fuse. Fuse rating is specified by in-rush current value at line turn-on. Do not select the

fuse according to input current (RMS.) values under the actual load condition.

- HWS300P : 12A
- HWS600P : 20A

8. Fan life expectancy

The Fan-life has limitation. Therefore, periodic maintenance by exchanging the life-expired fan is required for the power supply. The following figure shows the life of fan. The built-in FAN motor replacement is charged. Please contact to our sales office for FAN replacement.

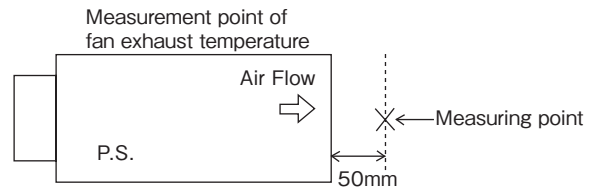
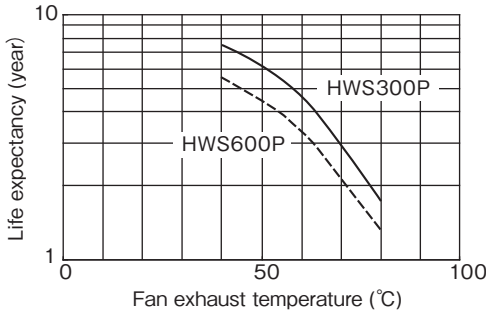

The difference between the intake temperature and the exhaust temperature of the Power supply at average load.

HWS300P : 4°C

HWS600P : 8°C

9. Before concluding that the unit is at fault...

Before concluding that the unit is at fault, make the following checks.

- (1) Check if the rated input voltage is connected.
- (2) Check if the wiring of input and output is correct.
- (3) Check if the I/O terminal connection is properly tighten by regulated torque.
- (4) Check if the wire thickness is enough.
- (5) Check if the output voltage control (V.adj) is properly adjusted. OVP might be trigged and output is shut down.
- (6) If use function of the Remote ON/OFF control, check if the Remote ON/OFF control connector is not opened. If in open condition, power supply will not output.
- (7) Check if the built-in FAN is not stopped. Is FAN stopped by something irregulars or etc?
If FAN stops, the PF signal turn "High" level and OTP might be activated.
- (8) Power supply has ventilating holes on the front and back panels. Check if there is any irregulars or dust, etc.
- (9) Is the chassis of power supply hot abnormally? The output is shut down by OTP operation.
Please re-input after the unit to cool down sufficiently.
- (10) Check if the output current and output wattage does not over specification.
- (11) Audible noise may be heard when input voltage waveform is not sinusoidal.
- (12) Audible noise may be heard during dynamic load operation.

10. Range of free warranty

This product is warranted for a period of 5 years from the date of shipment. As for the breakdown under a normal use during free warrantee term, repair is at free of charge. However, the built-in FAN motor replacement is charged.

Please contact to our sales office for FAN replacement. Please see "8. fan life expectancy" for the exchange time of fan.

Conditions of usage at the free of charge warrantee are as follows.

- (1) Average operating temperature (ambient temperature of the power supply unit) is under 40°C
- (2) Average load factor is 80% or less.
- (3) Mounting method : Standard mounting.

However, the maximum rating is within the output derating.

Following cases are not covered by warranty.

- (1) Improper usage like dropping products, applying shock and defects from operation exceeding specification of the units.
- (2) Defects resulting from natural disaster (fire, flood).
- (3) Unauthorized modifications or repair by the buyers defects not cause by TDK-Lambda.

Usage Precautions

WARNING

- Do not modify, disassemble, or open this product. Failure to do so can cause electric shock hazard. TDK-Lambda cannot be held responsible for damage caused by modifications to this product.
- Internal voltage can be retained inside the product. Do not touch any parts inside the product because there can be high-voltage and high-temperature parts even when the electric current is not applied. This can cause an electric shock hazard or burn injury.
- There can be high-voltage and high-temperature parts even in products without a cover. Do not touch them. Touching them can cause an electric shock hazard or burn injury.
- While electric current is being applied, keep your hands and face away from it. This may cause in-jury or an unexpected accident.

CAUTION

- Be sure to read the catalogue and instruction manual before using this product. For strictly accurate information, request the specifications of the delivered product to check the more detailed information. Incorrect usage could lead to an electric shock, damage to the product or a fire hazard.
- If there are differences between the specific information given for your product and this document, the specific information given for your product has priority.
- Use this product within the specified input voltage, output power, output voltage, output current, and range of ambient temperature/ambient humidity. Using this product in conditions beyond the specification limits can shorten the lifetime of the product, or can cause, damage to the product, electric shock, or a fire hazard. Also, measure the temperature inside the device to check that there are no problems.
- Check the direction the product should face and the conditions for ventilation in the specifications of the delivered product, and use the product in the correct manner.
- Disconnect the power input before connecting inputs and outputs.
- If an internal fuse becomes burned out, do not use the unit by replacing the fuse. This can cause trouble inside the unit. Be sure to request us to repair the unit.
- Insert fuses in the input circuit for products in which protection circuits (elements, fuses, etc.) are not installed, to prevent smoking or burning. Also for products with protection circuits installed inside, an appropriate use of protection circuits is recommended as there is possibility that the internal protection circuit may not operate depending on the usage conditions.

- Use only the fuses specified or recommended by TDK-Lambda for external fuses.
- This product is designed and manufactured as a component part to be installed in electronic devices. Attach the warning label to the unit and insert the notes in the instruction manual.
- Malfunction and failure may be caused if this product is used in a strong electromagnetic field.
- Failure may be caused in the power supply unit due to corrosion if used in environments with corrosive gas (hydrogen sulfide, sulfur dioxide, etc.).
- Malfunction and failure may be caused if this product is used in environments with conductive substances or dust.
- Be sure to take protective measures against the surge voltage caused by lightning, etc. Damage to the unit may be caused due to irregular voltage.
- Connect the frame ground terminal of the power supply unit to the earth terminal of the device, for safety and to reduce noise. If grounding is not made, it may cause an electric shock hazard.
- It is necessary to exchange consumable parts (built-in fan, electrolytic capacitor) periodically. Set an appropriate overhaul interval period for the performance of maintenance. There may be some cases where overhaul maintenance cannot be conducted due to unavailability of parts due to production discontinuation.
- This product might fail accidentally or through unexpected conditions. When using this product with application devices, in which an extremely high reliability is required (Nuclear-related devices, traffic control devices, medical devices, etc.), be sure to ensure that the fail-safe function is effective in the devices.

REMARKS

- As for EMI or immunity, they are measured in the TDK-Lambda standard conditions. It is not guaranteed that this product meets industry standards or regulations when being used in different conditions of mounting and wiring. Assess and evaluate values on the actual device before use.
- To export this product, follow the necessary procedures of application for the export license by the government of Japan, etc., complying with the regulations of the Foreign Exchange and Foreign Trade Control Law.
- The information in this catalogue is subject to change without prior notice.

X-ON Electronics

Largest Supplier of Electrical and Electronic Components

Click to view similar products for [Switching Power Supplies](#) category:

Click to view products by [TDK-Lambda](#) manufacturer:

Other Similar products are found below :

[70841011](#) [73-551-0005](#) [AAD600S-4-OP](#) [R22095](#) [KD0204](#) [9021](#) [S-15F-12](#) [LDIN100150](#) [LPM000-BBAR-01](#) [LPX17S-C](#) [EVS57-10R6/R](#)
[FDC40-24S12](#) [FP80](#) [FRV7000G](#) [22929](#) [CQM1IA121](#) [40370121900](#) [VI-PU22-EXX](#) [40370121910](#) [LDIN5075](#) [432703037161](#) [WRB01X-U](#)
[LPX140-C](#) [08-30466-1040G](#) [09-160CFG](#) [70841004](#) [70841025](#) [VPX3000-CBL-DC](#) [LPM000-BBAR-05](#) [LPM000-BBAR-08](#) [LPM124-](#)
[OUTA1-48](#) [LPM000-BBAR-07](#) [LPM109-OUTA1-10](#) [LPM616-CHAS](#) [08-30466-1055G](#) [08-30466-2175G](#) [DMB-EWG](#) [TVQF-1219-18S](#)
[6504-226-2101](#) [CQM1IPS01](#) [XPFM201A+](#) [MAP80-4000G](#) [LFP300F-24-TY](#) [SMP21-L20-DC24V-5A](#) [VI-MUL-ES](#) [08-30466-0065G](#)
[CME240P-24](#) [VI-RU031-EWWX](#) [08-30466-0028G](#) [S82Y-TS01](#)