

PAH SERIES

Single / Dual Output 50-450W

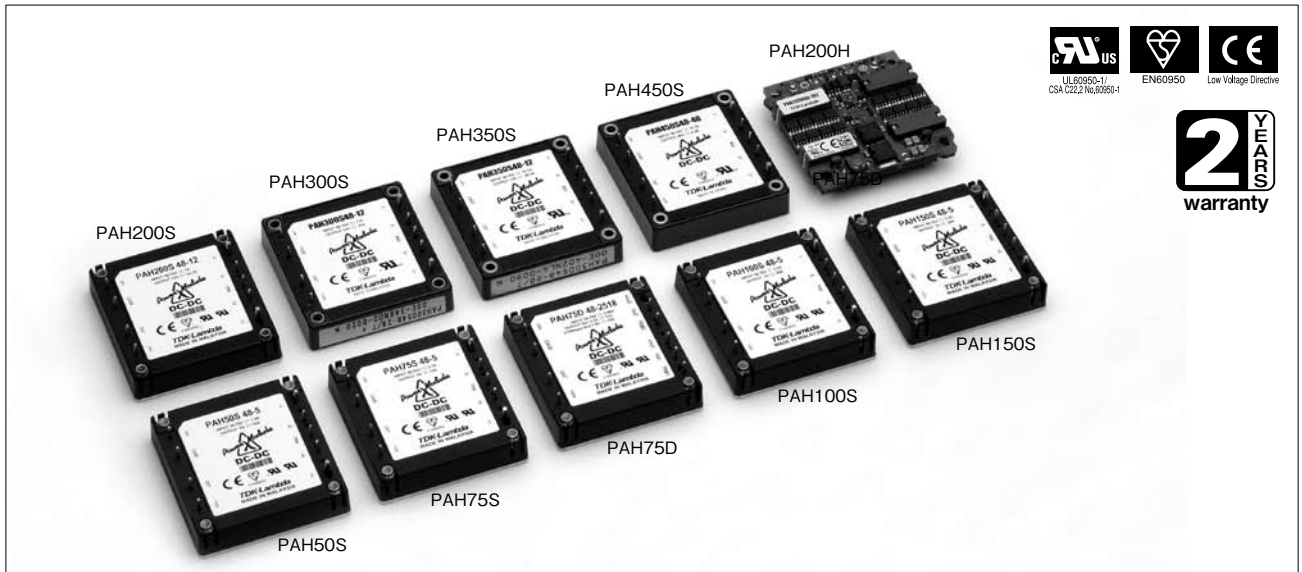

Features

- Half brick industry standard size (61×12.7×57.9 mm)
- High power density (industry-leading level in 450W full brick model)
- High efficiency: 92% (PAH450S48)
- Wide range of operating temperatures (Baseplate temperature: -40 to +100°C except PAH200H)
- Wide variation
- Built-in capacitor: Ceramic capacitor only (high reliability)
(Organic polymer semiconductor capacitor is also used for output smoothing in PAH200H/PAH75D.)

Model naming method

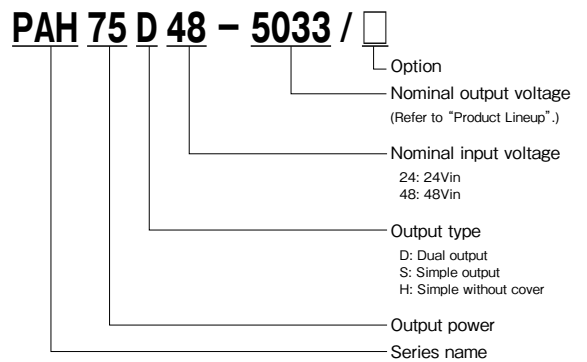

Applications



Conformity to RoHS Directive

This means that, in conformity with EU Directive 2002/95/EC, lead, cadmium, mercury, hexavalent chromium, and specific bromine-based flame retardants, PBB and PBDE, have not been used, except for exempted applications.

Product Line up

PAH-S24 (DC24Vin)				PAH-S48 (DC48Vin) ①							
Output Voltage	300W		350W		300W		350W		450W		
	Output Current	Model	Output Current	Model	Output Current	Model	Output Current	Model	Output Current	Model	
12V	25A	PAH300S24-12	—	—	25A	PAH300S48-12	29.2A	PAH350S48-12	—	—	
28V	11A	PAH300S24-28	12.5A	PAH350S24-28	11A	PAH300S48-28	12.5A	PAH350S48-28	16A	PAH450S48-28	
48V	—	—	7.3A	PAH350S24-48	—	—	—	—	4.9A	PAH450S48-48	

PAH-S48 (DC48Vin) ②										
Output Voltage	50W		75W		100W		150W		200W	
	Output Current	Model	Output Current	Model	Output Current	Model	Output Current	Model	Output Current	Model
1.2V	—	—	—	—	—	—	—	—	70A	PAH200H48-1R2
1.5V	—	—	—	—	—	—	—	—	70A	PAH200H48-1R5
1.8V	—	—	—	—	—	—	—	—	70A	PAH200H48-1R8
2.5V	11.7A	PAH50S48-2.5	17.5A	PAH75S48-2.5	23.4A	PAH100S48-2.5	35A	PAH150S48-2.5	70A	PAH200H48-2R5
3.3V	11.7A	PAH50S48-3.3	17.5A	PAH75S48-3.3	23.4A	PAH100S48-3.3	35A	PAH150S48-3.3	60A	PAH200H48-3R3
5V	10.0A	PAH50S48-5	15.0A	PAH75S48-5	20.0A	PAH100S48-5	30A	PAH150S48-5	—	—
12V	4.2A	PAH50S48-12	6.3A	PAH75S48-12	8.4A	PAH100S48-12	12.5A	PAH150S48-12	16.7A	PAH200S48-12
15V	3.4A	PAH50S48-15	5A	PAH75S48-15	6.7A	PAH100S48-15	10A	PAH150S48-15	13.4A	PAH200S48-15
24V	2.1A	PAH50S48-24	3.2A	PAH75S48-24	4.2A	PAH100S48-24	6.3A	PAH150S48-24	8.4A	PAH200S48-24
28V	1.8A	PAH50S48-28	2.7A	PAH75S48-28	3.6A	PAH100S48-28	5.4A	PAH150S48-28	7.2A	PAH200S48-28
48V	—	—	—	—	—	—	3.2A	PAH150S48-48	—	—

*) PAH200H Serie is without cover.

PAH75D (Dual Output)										
Output Voltage	75W									
	Output Current / Model		Output Current / Model		Output Current / Model		Output Current / Model		Output Current / Model	
1.8V	—	—	—	—	15.0A	—	15.0A	—	—	—
2.5V	15A	PAH75D24-3325	—	PAH75D24-5033	15.0A	PAH75D48-2518	15.0A	PAH75D483-3118	15.0A	PAH75D48-3325
3.3V	15A		15A		15.0A		15.0A		15.0A	
5V	—	—	—	—	—	—	—	—	15.0A	PAH75D48-5033

• All specifications are subject to change without notice.

PAH50S48 Specifications

ITEMS/UNITS		MODEL	PAH50S48-2.5	PAH50S48-3.3	PAH50S48-5	PAH50S48-12	PAH50S48-15	PAH50S48-24	PAH50S48-28
Input	Voltage Range	V	36 - 76 VDC						
	Efficiency (typ) (*1)	%	76	79	83	85		86	87
	Current (typ) (*1)	A	0.8	1.02	1.26	1.24	1.25	1.22	1.21
Output	Nominal Voltage	VDC	2.5	3.3	5	12	15	24	28
	Minimum Current	A	0						
	Maximum Current	A	11.7		10	4.2	3.4	2.1	1.8
	Maximum Power	W	29.25	38.61	50.0	50.4	51.0	50.4	
	Voltage Setting Accuracy (*1)	%	±1.6						
	Maximum Line Regulation(*4)(*12)	mV	10			24	30	48	56
	Maximum Load Regulation(*5)(*12)	mV	10			24	30	48	56
	Temperature Coefficient		0.02%/°C						
	Maximum Ripple & Noise (-20~+100°C)(*3)	mVp-p	150			200	240	280	
	Maximum Ripple & Noise (-40~-20°C)(*3)	mVp-p	300			250	300	350	
	Voltage Adjustable Range (*2)		±10%		+15%, -40%	+10%, -40%			
	Function	Over Current Protection (*6)		105 - 150%					
Over Voltage Protection (*7)			120 - 160%	120 - 140%	125 - 145%				
Over Voltage Protection (*7)			Inverter shutdown (Option available: Refer to option table)						
Over Temperature Protection			Shutdown ; Auto-restart when unit cool down						
Remote Sensing (*10)			Possible (Connect +S and -S terminals to load)						
Remote ON/OFF Control (*8)			Negative logic (Option available: Refer to option table)						
Parallel Operation			-----						
Series Operation			Possible						
Environment	Operating Temperature	°C	-40 to +100 (Baseplate) Ambient temperature MIN =-40						
	Storage Temperature	°C	-40 to +100 (Baseplate) Ambient temperature MIN =-40						
	Operating Humidity	%RH	30 - 95 (No dewdrop)						
	Storage Humidity	%RH	30 - 95 (No dewdrop)						
	Vibration		At no operating, 10 - 55Hz amplitude (sweep 1 MIN) 0.825mm constant (maximum 49.0m/s ²) X,Y,Z 1 hr each						
	Shock		196.1						
	Cooling	(*9)	Conduction cooled						
Isolation	Withstand Voltage		Input - Output : 1.5kVAC, Input - Baseplate : 1.5kVAC (20mA) for 1 min Output - Baseplate : .500VDC for 1 min						
	Isolation Resistance		More than 100MOHM at 25°C and 70 %RH, Output - Baseplate : 500 VDC						
Standards	Safety Standards		Approved by UL60950-1, CSA C22.2 No.60950-1, EN60950-1.						
Mechanical	Weight	g	80						
	Size (W x H x D)	mm	57.9 x 12.7 x 61 (Refer to outline drawing)						

(*1) At 48 VDC, maximum output power and baseplate temperature = +25°C.

(*2) Additional external components have to be connected; refer to application notes.

(*3) External components are needed; Refer to basical connection drawing.

(*4) 36 - 76 VDC, constant load.

(*5) No load - full load, constant input voltage.

(*6) Current limiting with automatic recovery.

(*7) CNT reset or manual reset.

(*8) Refer to application notes.

(*9) Heatsink has to be chosen according to application notes.

(*10) If remote sensing is not required, connect +S and -S to +V and -V respectively (Refer to basical connection).

(*12) For -40°C to -20°C operation, the regulation for output 2.5V, 3.3V, 5V, 12V AND 15V is 40 mV.

Option table:

Option	ON/OFF Logic	OVP
Standard	Negative (H: OFF, L: ON)	Shut-down (ON/OFF control reset or manual reset)
/P	Positive (H: ON, L: OFF)	
/V	Negative (H: OFF, L: ON)	Auto restart
/PV	Positive (H: ON, L: OFF)	

Example: PAH50S48-5/P represent positive logic & OVP shut-down

Outline Drawing

[PAH50S]

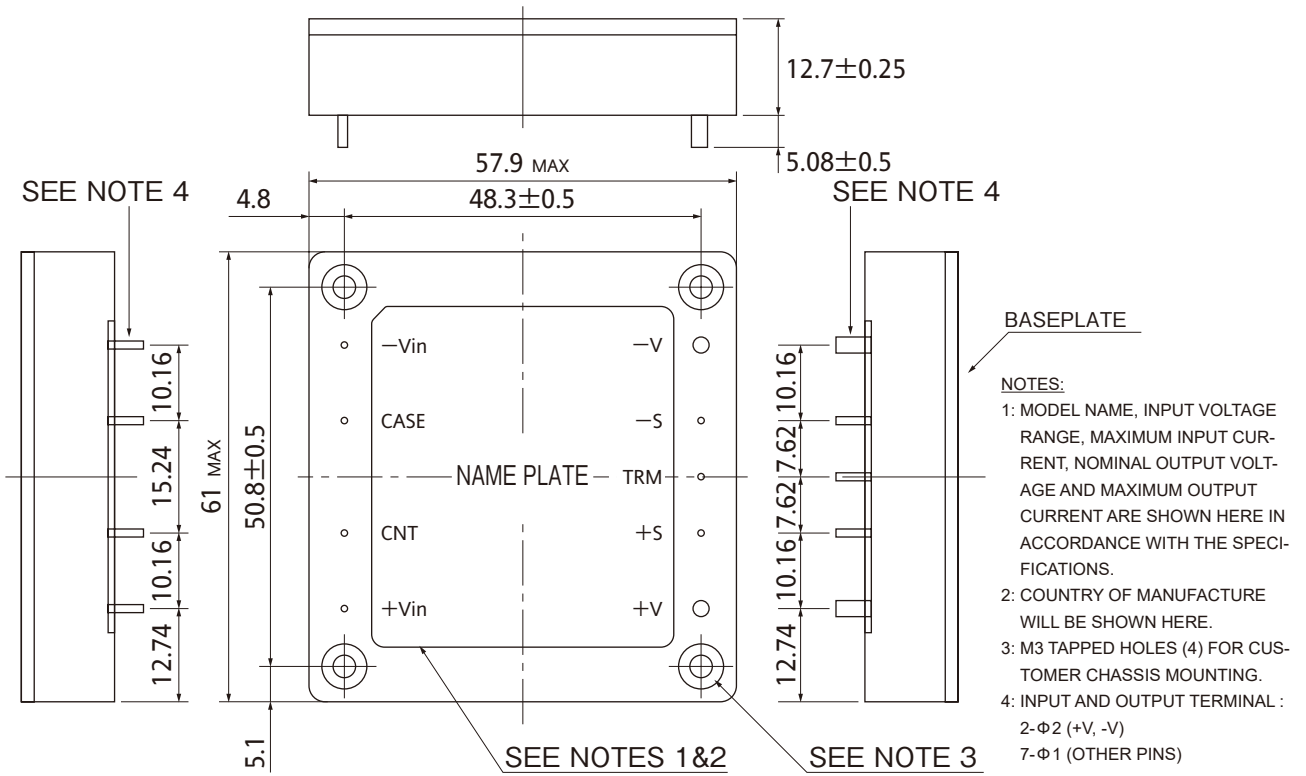

PAH

(unit : mm)

Derating Curve

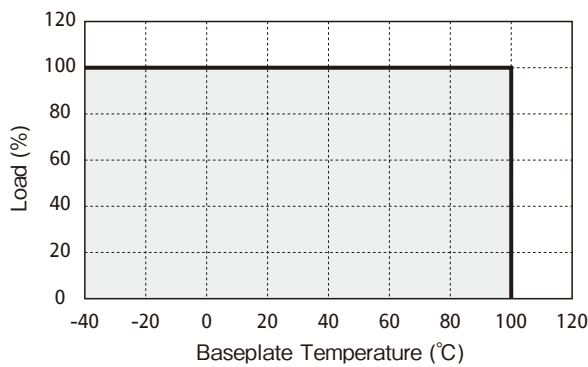

PAH75S48 Specifications

ITEMS/UNITS		MODEL	PAH75S48-2.5	PAH75S48-3.3	PAH75S48-5	PAH75S48-12	PAH75S48-15	PAH75S48-24	PAH75S48-28
Input	Voltage Range	V	DC36 - 76						
	Efficiency (typ) (*1)	%	76	79	83	85		87	
	Current (typ) (*1)	A	1.20	1.52	1.88	1.85	1.84		1.81
Output	Nominal Voltage	VDC	2.5	3.3	5	12	15	24	28
	Minimum Current	A	0						
	Maximum Current	A	17.5		15	6.3	5	3.2	2.7
	Maximum Power	W	43.75	57.75	75.0	75.6	75.0	76.8	75.6
	Voltage Setting Accuracy (*1)	%	±1.6						
	Maximum Line Regulation(*4)(*12)	mV	10			24	30	48	56
	Maximum Load Regulation(*5)(*12)	mV	10			24	30	48	56
	Temperature Coefficient		0.02%/°C						
	Maximum Ripple & Noise (-20 to +100°C) (*3)	mVp-p	150			200	240	280	
	Maximum Ripple & Noise (-40 to -20°C) (*3)	mVp-p	300			250	300	350	
	Voltage Adjustable Range (*2)		±10%		+15%, -40%	+10%, -40%			
	Function	Over Current Protection (*6)		105 - 150%					
Over Voltage Protection (*7)			120 - 160%	120 - 140%	125 - 145%				
			Inverter shutdown (Option available: Refer to option table)						
Over Temperature Protection			Shutdown ; Auto-restart when unit cool down						
Remote Sensing (*10)			Possible (Connect +S and -S terminals to load)						
Remote ON/OFF Control (*8)			Negative logic (Option available: Refer to option table)						
Parallel Operation			-						
Environment	Series Operation		Possible						
	Operating Temperature	°C	-40 to +100 (Baseplate)			Ambient temperature min = -40			
	Storage Temperature	°C	-40 to +100 (Baseplate)			Ambient temperature min = -40			
	Operating Humidity	%RH	30 - 95 (No dewdrop)						
	Storage Humidity	%RH	30 - 95 (No dewdrop)						
	Vibration		At no operating, 10 ~ 55Hz amplitude (sweep 1 min) 0.825mm constant (maximum 49.0m/s ²) X, Y, Z 1 hr each						
	Shock		196.1m/s ²						
	Cooling (*9)		Conduction cooled						
Isolation	Withstand Voltage		Input - Output : 1.5kVAC, Input - Baseplate : 1.5kVAC (20mA) for 1 min Output - Baseplate : .500VDC for 1 min						
	Isolation Resistance		More than 100MOHM at 25°C and 70 %RH, Output - Baseplate : 500 VDC						
Standards	Safety Standards		Approved by UL60950-1, CSA-C 22.2 No.60950-1, EN60950-1.						
Mechanical	Weight	g	80						
	Size (W x H x D)	mm	57.9 x 12.7 x 61 (Refer to outline drawing)						

- (*1) At 48 VDC, maximum output power and baseplate temperature = +25°C.
- (*2) Additional external components have to be connected; Refer to application notes.
- (*3) External components are needed; Refer to basical connection drawing.
- (*4) 36 - 76 VDC, constant load.
- (*5) No load - full load, constant input voltage.
- (*6) Current limiting with automatic recovery.
- (*7) CNT reset or manual reset.
- (*8) Refer to application notes.
- (*9) Heatsink has to be chosen according to application notes.
- (*10) If remote sensing is not required, connect +S and -S to +V and -V respectively (Refer to basical connection).
- (*12) For -40°C to -20°C operation, the regulation for output 2.5V, 3.3V, 5V, 12V and 15V is 40 mV.

Option table:

Option	ON/OFF Logic	OVP
Standard	Negative (H: OFF, L: ON)	Shut-down (ON/OFF control reset or manual reset)
/P	Positive (H: ON, L: OFF)	
/V	Negative (H: OFF, L: ON)	Auto restart
/PV	Positive (H: ON, L: OFF)	

Example: PAH75S48-5/P represent positive logic & OVP shut-down

Outline Drawing

[PAH75S48]

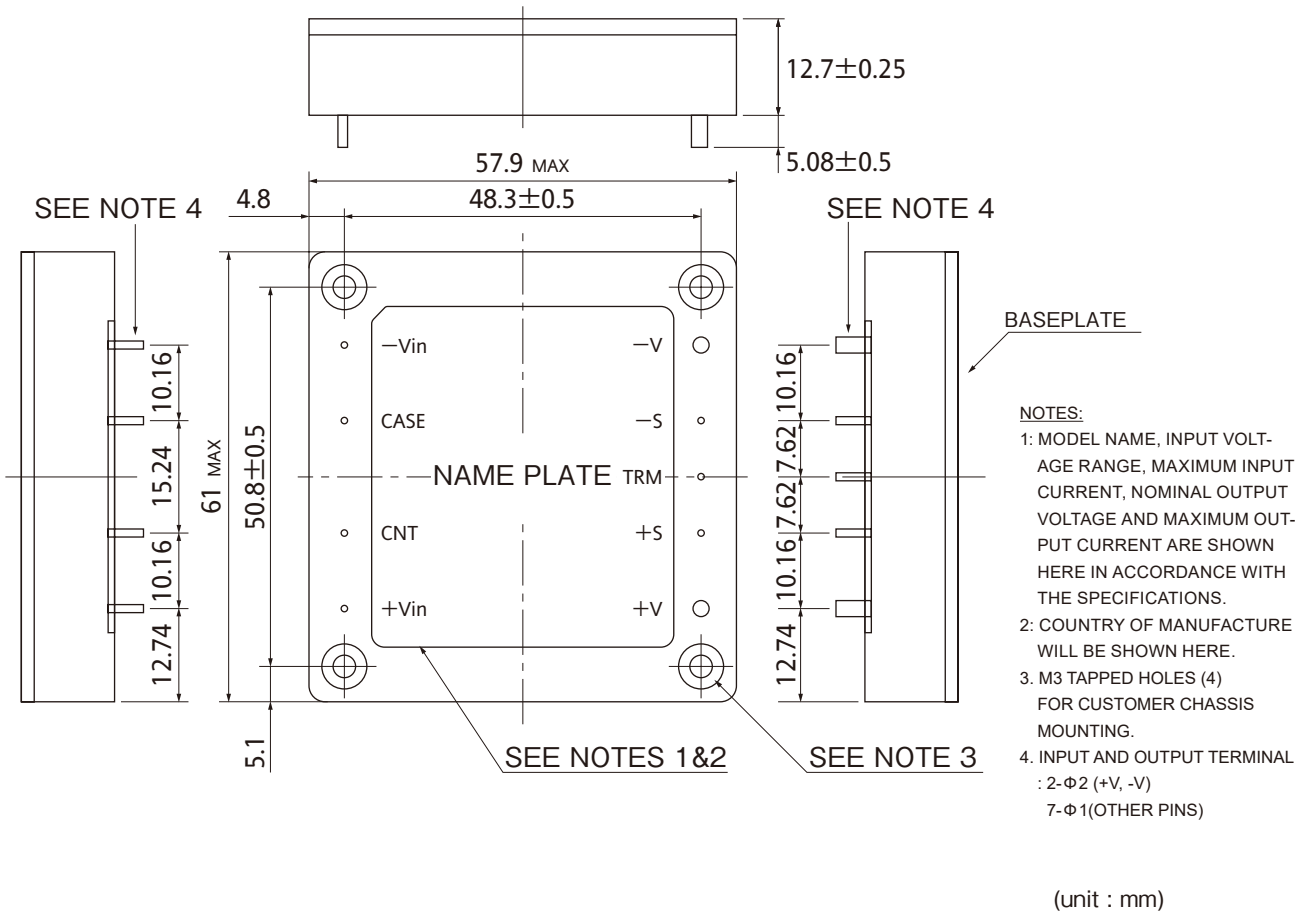

PAH

Derating Curve

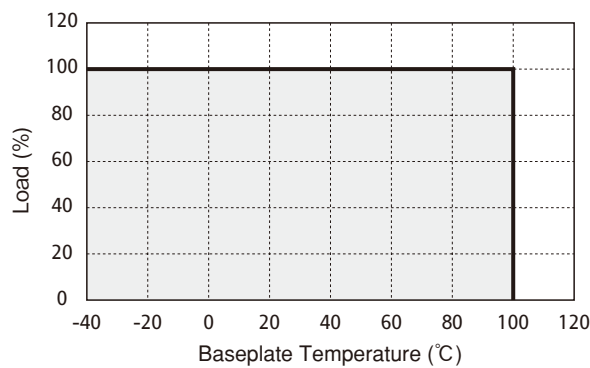

PAH100S48 Specifications

ITEMS/UNITS		MODEL	PAH100S48-2.5	PAH100S48-3.3	PAH100S48-5	PAH100S48-12	PAH100S48-15	PAH100S48-24	PAH100S48-28
Input	Voltage Range	V	DC36 - 76						
	Efficiency (typ) (*1)	%	75	80	84	86		88	
	Current (typ) (*1)	A	1.63	2.01	2.48	2.44		2.39	
Output	Nominal Voltage	VDC	2.5	3.3	5	12	15	24	28
	Minimum Current	A	0						
	Maximum Current	A	23.4		20.0	8.4	6.7	4.2	3.6
	Maximum Power	W	58.5	77.22	100.0	100.8	100.5	100.8	
	Voltage Setting Accuracy (*1)	%	±1.6						
	Maximum Line Regulation(*4)	mV	10			24	30	48	56
	Maximum Load Regulation(*5)	mV	10			24	30	48	56
	Temperature Coefficient		0.02%/°C						
	Maximum Ripple & Noise (-20~+100°C)(*3)	mVp-p	150			200	240	280	
	Maximum Ripple & Noise (-40~-20°C)(*3)	mVp-p	200			250	300	350	
	Voltage Adjustable Range (*2)		±10%		+15%, -40%	+10%, -40%			
	Function	Over Current Protection (*6)		105 - 150%					
Over Voltage Protection (*7)			120 - 160%	120 - 140%	125 - 145%				
Over Temperature Protection			Shutdown ; Auto-restart when unit cool down						
Remote Sensing (*10)			Possible (Connect +S and -S terminals to load)						
Remote ON/OFF Control (*8)			Negative logic (Option available: Refer to option table)						
Parallel Operation			-						
Series Operation			Possible						
Environment	Operating Temperature	°C	-40 to +100 (Baseplate)		Ambient temperature min = -40°C				
	Storage Temperature	°C	-40 to +100 (Baseplate)		Ambient temperature min = -40°C				
	Operating Humidity	%RH	30 - 95 (No dewdrop)						
	Storage Humidity	%RH	30 - 95 (No dewdrop)						
	Vibration		At no operating, 10 ~ 55Hz amplitude (sweep 1 min) 0.825mm constant (maximum 49.0m/s ²) X, Y, Z 1 hr each						
	Shock		196.1m/s ²						
	Cooling (*9)		Conduction cooled						
Isolation	Withstand Voltage		Input - Output : 1.5kVAC, Input - Baseplate : 1.5kVAC (20mA) for 1 min Output - Baseplate : .500VDC for 1 min						
	Isolation Resistance		More than 100MOHM at 25°C and 70 %RH, Output - Baseplate : 500 VDC						
Standards	Safety Standards		Approved by UL60950-1, CSA C22.2 No.60950-1, EN60950-1.						
Mechanical	Weight	g	80						
	Size (W x H x D)	mm	57.9 x 12.7 x 61 (Refer to outline drawing)						

(*1) At 48 VDC, maximum output power and baseplate temperature = +25°C.

(*2) Additional external components have to be connected; Refer to application notes.

(*3) External components are needed; Refer to basical connection drawing.

(*4) 36 - 76 VDC, constant load.

(*5) No load - full load, constant input voltage.

(*6) Current limiting with automatic recovery.

(*7) CNT reset or manual reset.

(*8) Refer to application notes.

(*9) Heatsink has to be chosen according to application notes.

(*10) If remote sensing is not required, connect +S and -S to +V and -V respectively (Refer to basical connection.)

Option table:

Option	ON/OFF Logic	OVP
Standard	Negative (H: OFF, L: ON)	Shut-down (ON/OFF control reset or manual reset)
/P	Positive (H: ON, L: OFF)	
/V	Negative (H: OFF, L: ON)	Auto restart
/PV	Positive (H: ON, L: OFF)	

Example: PAH100S48-5/P represent positive logic & OVP shut-down

Outline Drawing

[PAH100S48]

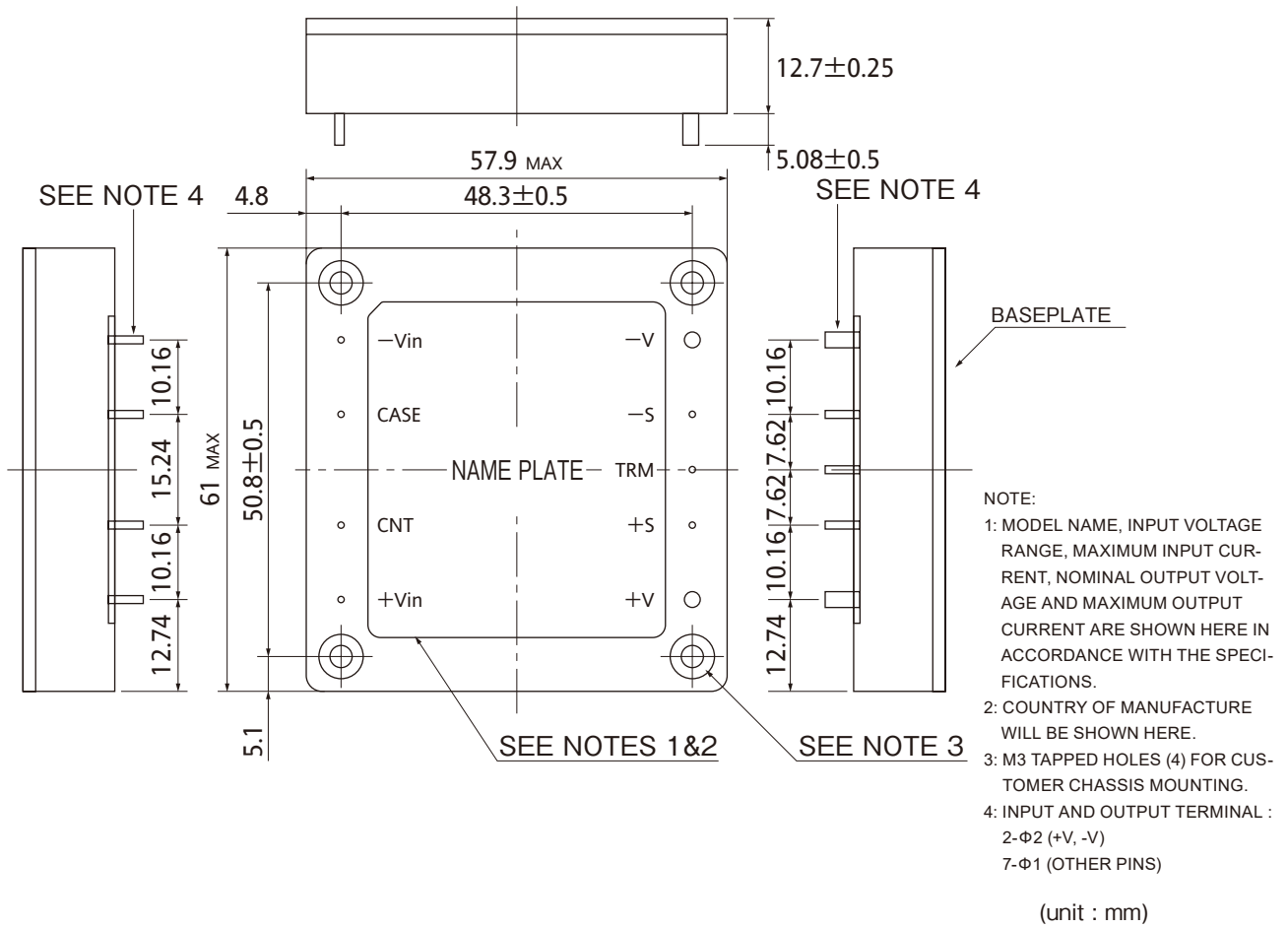

PAH

Derating Curve

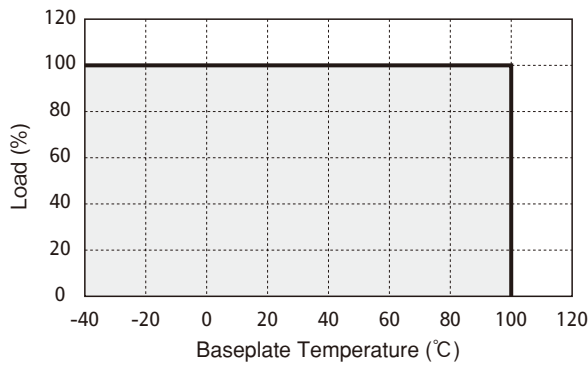

PAH150S48 Specifications

ITEMS/UNITS		MODEL	PAH150S48-2.5	PAH150S48-3.3	PAH150S48-5	PAH150S48-12	PAH150S48-15	PAH150S48-24	PAH150S48-28	PAH150S48-48
Input	Voltage Range	V	DC36 - 76							
	Efficiency (typ) (*1)	%	75	80	84	86		88		
	Current (typ) (*1)	A	2.43	3.01	3.72	3.63		3.58		3.64
Output	Nominal Voltage	VDC	2.5	3.3	5	12	15	24	28	48
	Minimum Current	A	0							
	Maximum Current	A	35		30	12.5	10	6.3	5.4	3.2
	Maximum Power	W	87.5	115.5	150		151.2		153.6	
	Voltage Setting Accuracy (*1)	%	±1.6							
	Maximum Line Regulation(*4)	mV	10			24	30	48	56	96
	Maximum Load Regulation(*5)	mV	10			24	30	48	56	96
	Temperature Coefficient		0.02%/°C							
	Maximum Ripple & Noise (-20 to +100°C) (*3)	mVp-p	150			200		240	280	250
	Maximum Ripple & Noise (-40 to -20°C) (*3)	mVp-p	200			250		300	350	400
	Voltage Adjustable Range (*2)		±10%		+15%, -40%	+10%, -40%			±20%	
	Function	Over Current Protection (*6)		105 - 150%						
Over Voltage Protection (*7)			120 - 160%	120 - 140%	125 - 145%				135 - 155%	
			Inverter shutdown (Option available: Refer to option table)							
Over Temperature Protection			Shutdown ; Auto-restart when unit cool down							
Remote Sensing (*10)			Possible (Connect +S and -S terminals to load)							
Remote ON/OFF Control (*8)			Negative logic (Option available: Refer to option table)							
Parallel Operation			-							
	Series Operation		Possible							
Environment	Operating Temperature	°C	-40 to +100 (Baseplate) Ambient temperature min = -40°C							
	Storage Temperature	°C	-40 to +100 (Baseplate) Ambient temperature min = -40°C							
	Operating Humidity	%RH	30 - 95 (No dewdrop)							
	Storage Humidity	%RH	30 - 95 (No dewdrop)							
	Vibration		At no operating, 10 ~ 55Hz amplitude (sweep 1 min) 0.825mm constant (maximum 49.0m/s ²) X, Y, Z 1 hr each							
	Shock		196.1 m/s ²							
	Cooling (*9)		Conduction cooled							
Isolation	Withstand Voltage		Input - Output : 1.5kVAC, Input - Baseplate : 1.5kVAC (20mA) for 1 min Output - Baseplate : .500VDC for 1 min							
	Isolation Resistance		More than 100MOHM at 25°C and 70 %RH, Output - Baseplate : 500 VDC							
Standards	Safety Standards		Approved by UL60950-1, CSA C22.2 No.60950-1, EN60950-1.							
Mechanical	Weight	g	80							
	Size (W x H x D)	mm	57.9 x 12.7 x 61 (Refer to outline drawing)							

(*1) At 48 VDC, maximum output power and baseplate temperature = +25°C.

(*2) Additional external components have to be connected; Refer to application notes.

(*3) External components are needed; Refer to basical connection drawing.

(*4) 36 - 76 VDC, constant load.

(*5) No load - full load, constant input voltage.

(*6) Current limiting with automatic recovery.

(*7) CNT reset or manual reset.

(*8) Refer to application notes.

(*9) Heatsink has to be chosen according to application notes.

(*10) If remote sensing is not required, connect +S and -S to +V and -V respectively (Refer to basical connection.)

Option table:

Option	ON/OFF Logic	OVP
Standard	Negative (H: OFF, L: ON)	Shut-down (ON/OFF control reset or Manual reset)
/P	Positive (H: ON, L: OFF)	
/V	Negative (H: OFF, L: ON)	Auto restart
/PV	Positive (H: ON, L: OFF)	

Example: PAH150S48-5/P represent positive logic & OVP shut-down

Outline Drawing

[PAH150S48]

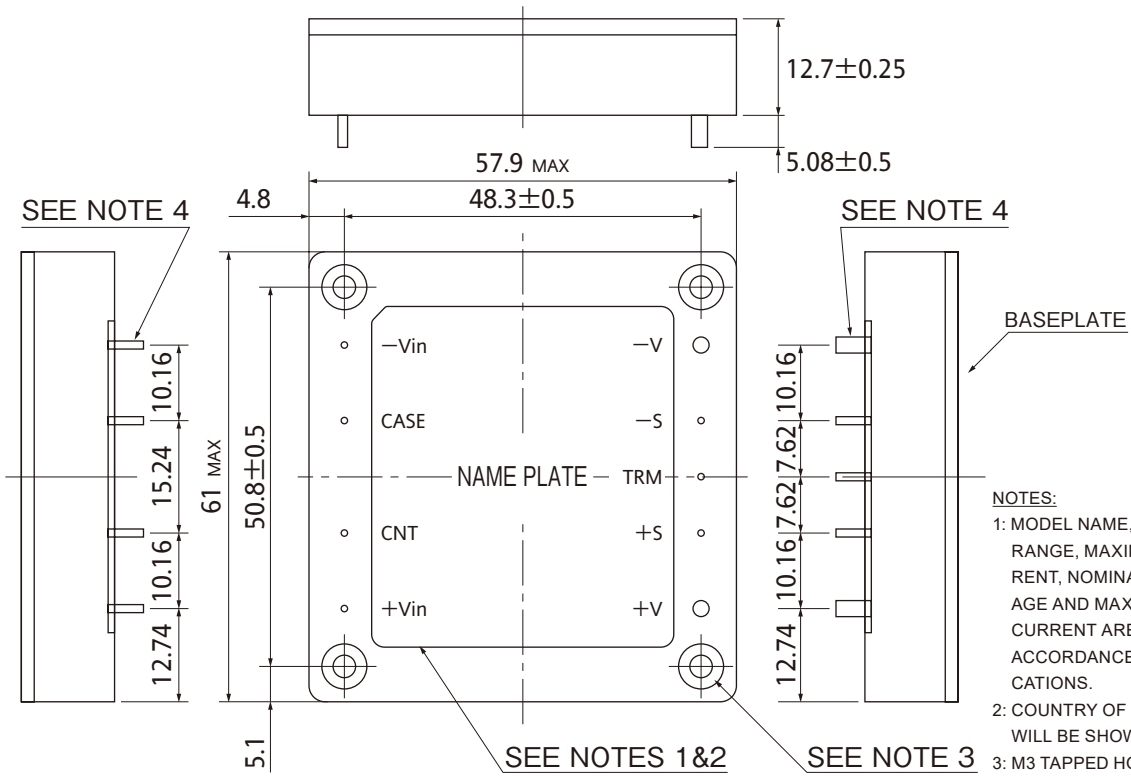

- NOTES:**
- 1: MODEL NAME, INPUT VOLTAGE RANGE, MAXIMUM INPUT CURRENT, NOMINAL OUTPUT VOLTAGE AND MAXIMUM OUTPUT CURRENT ARE SHOWN HERE IN ACCORDANCE WITH THE SPECIFICATIONS.
 - 2: COUNTRY OF MANUFACTURE WILL BE SHOWN HERE.
 - 3: M3 TAPPED HOLES (4) FOR CUSTOMER CHASSIS MOUNTING.
 - 4: INPUT AND OUTPUT TERMINAL :
 2-Φ2 (+V, -V)
 7-Φ1 (OTHER PINS)
- (unit:mm)

PAH

Derating Curve

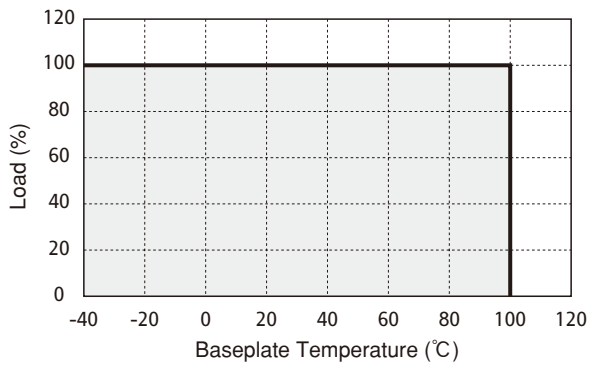

PAH200S48 Specifications

ITEMS/UNITS		MODEL	PAH200S48-12	PAH200S48-15	PAH200S48-24	PAH200S48-28
Input	Voltage Range	V	DC36 - 76			
	Efficiency (typ) (*1)	%	85		87	
	Current (typ) (*1)	A	4.91	4.92	4.82	
Output	Nominal Voltage	VDC	12	15	24	28
	Minimum Current	A	0			
	Maximum Current	A	16.7	13.4	8.4	7.2
	Maximum Power	W	200.4	201.0	201.6	
	Voltage Setting Accuracy (*1)	%	±1.6			
	Maximum Line Regulation(*4)	mV	24	30	48	56
	Maximum Load Regulation (*5)	mV	24	30	48	56
	Temperature Coefficient		0.02%/°C			
	Maximum Ripple & Noise (-20 to +100°C) (*3)	mVp-p	200		240	280
	Maximum Ripple & Noise (-40 to -20°C) (*3)	mVp-p	250		300	350
Voltage Adjustable Range (*2)		+10%, -40%				
Function	Over Current Protection (*6)		105 -150%			
	Over Voltage Protection (*7)		125 - 145%			
	Over Temperature Protection		Inverter shutdown (Option available: Refer to option table)			
	Remote Sensing (*10)		Shutdown ; Auto-restart when unit cool down			
	Remote ON/OFF Control (*8)		Possible (Connect +S and -S terminals to load)			
	Parallel Operation		Negative logic (Option available: Refer to option table)			
	Series Operation		-			
Environment	Operating Temperature (*11)	°C	Baseplate -40 to +80 : 100% of max. load ; min. Ta = -40 +100 : 90% of max. load			
	Storage Temperature	°C	-40 to +100 (Baseplate) Ambient temperature min = -40			
	Operating Humidity	%RH	30 - 95 (No dewdrop)			
	Storage Humidity	%RH	30 - 95 (No dewdrop)			
	Vibration		At no operating, 10 - 55Hz amplitude (sweep 1 min) 0.825mm Constant (maximum 49.0m/s ²) X, Y, Z 1 hr each			
	Shock		196.1m/s ²			
	Cooling (*9)		Conduction cooled			
Isolation	Withstand Voltage		Input - Output : 1.5kVAC, Input - Baseplate : 1.5kVAC (20mA) for 1 min Output - Baseplate : .500VDC for 1 min			
	Isolation Resistance		More than 100MOHM at 25°C and 70 %RH, Output - Baseplate : 500 VDC			
Standards	Safety Standards		Approved by UL60950-1, CSA C22.2 No.60950-1, EN60950-1.			
Mechanical	Weight	g	80			
	Size (W x H x D)	mm	57.9 x 12.7 x 61 (Refer to outline drawing)			

(*1) At 48 VDC, maximum output power and baseplate temperature = +25°C.

(*2) Additional external components have to be connected; Refer to application notes.

(*3) External components are needed; Refer to basical connection drawing.

(*4) 36 ~ 76 VDC, constant load.

(*5) No load ~ full load, constant input voltage.

(*6) Current limiting with automatic recovery.

(*7) CNT reset or manual reset.

(*8) Refer to application notes.

(*9) Heatsink has to be chosen according to application notes.

(*10) If remote sensing is not required, connect +S and -S to +V and -V respectively (Refer to basical connection.)

(*11) Refer to output derating curve.

Option table:

Option	ON/OFF Logic	OVP
Standard	Negative (H: OFF, L: ON)	Shut-down (ON/OFF control reset or manual reset)
/P	Positive (H: ON, L: OFF)	
/V	Negative (H: OFF, L: ON)	Auto restart
/PV	Positive (H: ON, L: OFF)	

Example: PAH200S48-5/P represent positive logic & OVP shut-down

Outline Drawing

[PAH200S48]

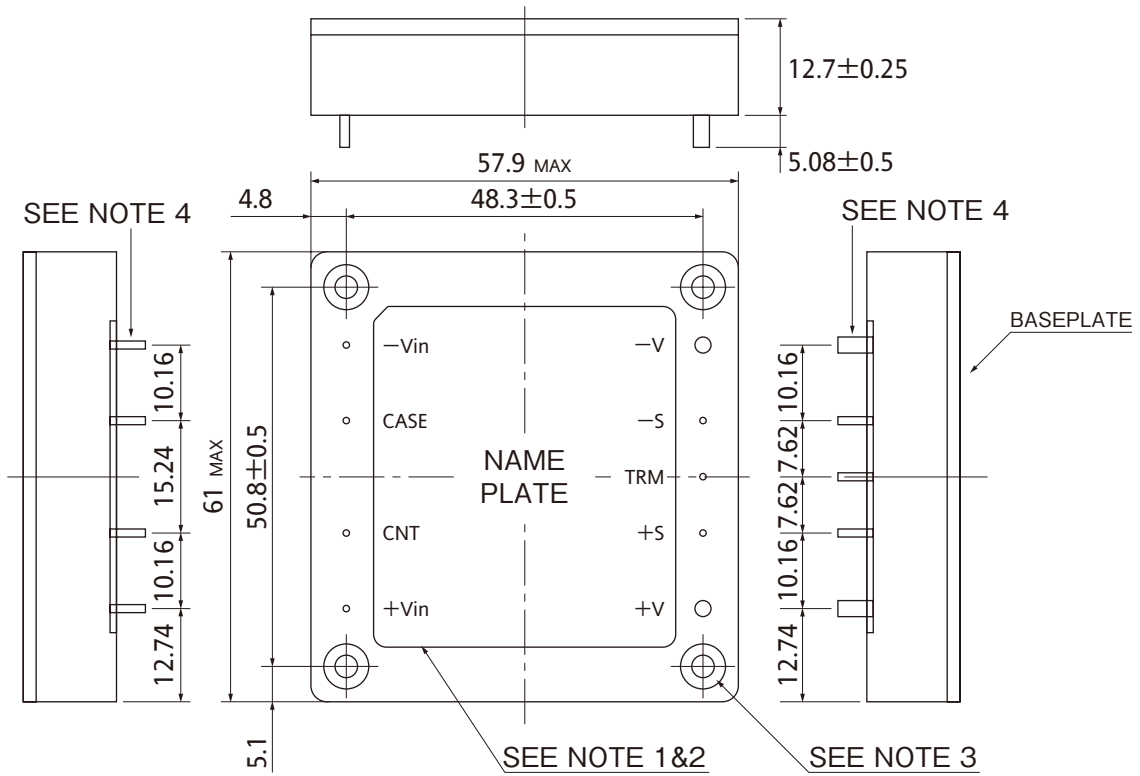

NOTES:

- 1: MODEL NAME, INPUT VOLTAGE RANGE, MAXIMUM INPUT CURRENT, NOMINAL OUTPUT VOLTAGE AND MAXIMUM OUTPUT CURRENT ARE SHOWN HERE IN ACCORDANCE WITH THE SPECIFICATIONS.
- 2: COUNTRY OF MANUFACTURE WILL BE SHOWN HERE.
- 3: M3 TAPPED HOLES (4) FOR CUSTOMER CHASSIS MOUNTING.
- 4: INPUT AND OUTPUT TERMINAL : 2-Φ2 (+V, -V), 7-Φ1 (OTHER PINS)

(unit : mm)

Derating Curve

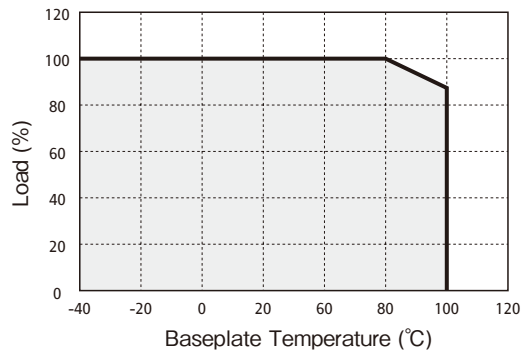

PAH200H Specifications

ITEMS/UNITS		MODEL	PAH200H48-1R2	PAH200H48-1R5	PAH200H48-1R8	PAH200H48-2R5	PAH200H48-3R3
Input	Voltage Range (*6)	V	DC36 - 76 (100VDC, 100ms)				
	Efficiency (typ) (*1)	%	82	84	87	88	90
	Current (typ) (*1)	A	2.19	2.67	3.08	4.23	4.68
Output	Nominal Voltage	VDC	1.2	1.5	1.8	2.5	3.3
	Maximum Current	A	70				60
	Maximum Power	W	84	105	126	175	198
	Voltage Setting Accuracy (*1)	%	±1				
	Maximum Line Regulation (*2)	mV	10				
	Maximum Load Regulation (*3)	mV	10				
	Temperature Coefficient		Less than 0.02%/°C				
	Maximum Ripple & Noise (*8)	mVp-p	100				
	Voltage Adjustable Range(*8)		-20%, +10%				
Function	Over Current Protection (*4)		105% - 140% (Option available : Refer to option table)				
	Over Voltage Protection (*5)		120% - 140% (Option available : Refer to option table)				
	Remote Sensing (*6)		Possible				
	Remote ON/OFF Control		Possible (Option available : Refer to option table)				
	Parallel Operation (*6)		-				
	Series Operation (*6)		Possible				
Environment	Operating Temperature (*7)	°C	Ta= -40 to +85				
	Storage Temperature	°C	-40 to +100				
	Operating Humidity	%RH	5 - 95 (No dewdrop)				
	Storage Humidity	%RH	5 - 95 (No dewdrop)				
	Vibration		At no operating, 10-55Hz (sweep for 1min.) Amplitude 0.825mm constant (maximum 49.0m/s ²) X, Y, Z 1 hour each				
	Shock		196.1m/s ²				
	Cooling	(*7)	Convection cooled / Forced air cooled				
Isolation	Withstand Voltage		Input-Output : 1.5kVDC for 1min				
	Isolation Resistance		More than 100MΩ at 25°C and 70%RH Input-Output...500VDC				
Standards	Safety Standards		Approved by UL60950-1, CSA C22.2 No.60950-1, EN60950-1.				
Mechanical	Weight (typ)	g	90				
	Size (W x H x D)	mm	61 x 10.2 x 57.9 (Refer to outline drawing)				

(*1) At 48VDC, maximum output current, air velocity = 2m/s and Ta = +25°C.

(*2) 36 - 76VDC, constant load.

(*3) No load - full load, constant input voltage.

(*4) Constant current limiting. (The unit automatically shutdown when left in OCP condition with the output voltage less than the LVP level.)
Auto restart option available.

(*5) Inverter shutdown method, manual reset. Auto restart option available.

(*6) Refer to instruction manual.

(*7) Refer to derating curve and instruction manual.

(*8) External components are needed for operation.
(Refer to basic connection. and instruction manual.)

Basic connections

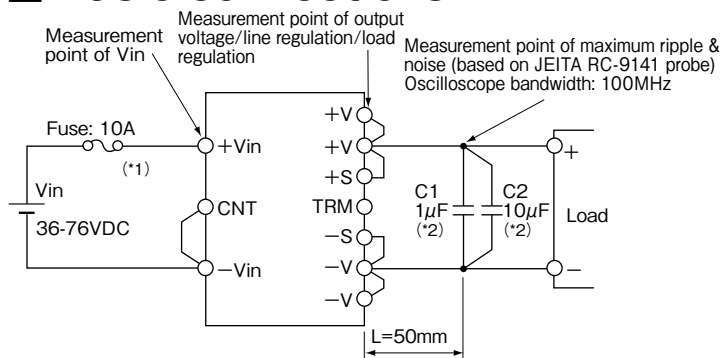

(*1) 1: The PAH200H series is not equipped with a fuse. Be sure to set a fast-blow fuse for the enhancement of safety and to get approval for safety standards. When using multiple units of the PAH200H series, set a fuse for each unit.

(*2) C1: 1µF ceramic capacitor
C2: 10µF electrolytic capacitor or tantalum capacitor

Option table:

Option	ON/OFF Logic	OVP, OCP
Standard	Negative (Short: ON, Open: OFF)	Shut-down (ON/OFF control reset or manual reset)
		Auto restart
/P	Positive (Short: OFF, Open: ON)	Shut down (ON/OFF control reset or manual reset)
/PV		Auto restart

Outline Drawing

[PAH200H]

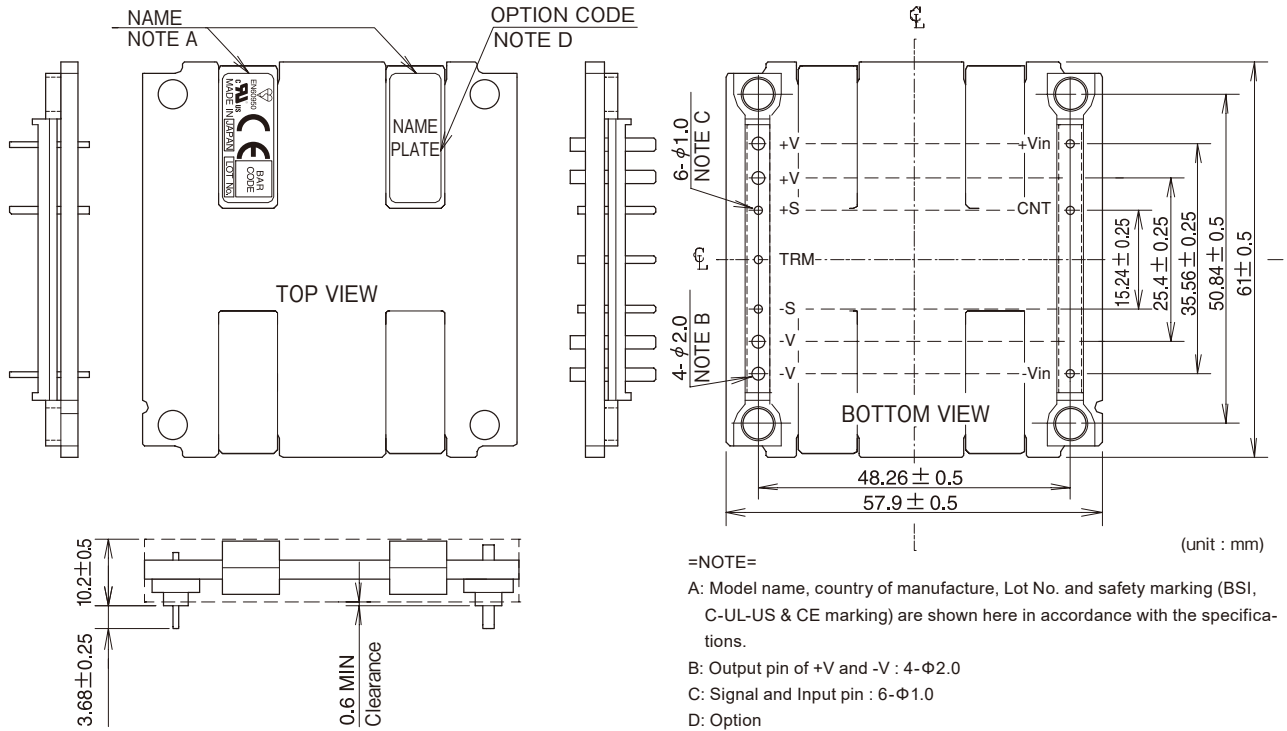

PAH

OPTION CODE	OVP/OC	REMOTE ON/OFF CONTROL
NOTHING	SHUT DOWN (ON/OFF CONT. RESET OR MANUAL RESET)	NEGATIVE (SHORT : ON OPEN : OFF)
/V	AUTO RESTART	
/P	SHUT DOWN (ON/OFF CONT. RESET OR MANUAL RESET)	POSITIVE (SHORT : OFF OPEN : ON)
/PV	AUTO RESTART	

Output Derating

● **Output derating by ambient temperature**
Please refer to instruction manual.

● **Output derating by PCB temperature**

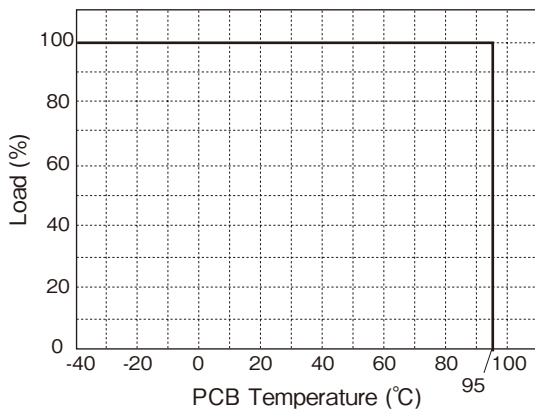

When using with different measurement conditions from output derating by ambient temperature, use output derating by PCB temperature. PCB temperature is decided by temperature of the component surface below. Measurement of PCB temperature is recommended to ensure the module to operate within the derating curve.

Measuring point of PCB temperature

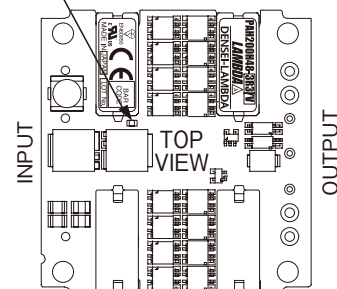

Block Diagram

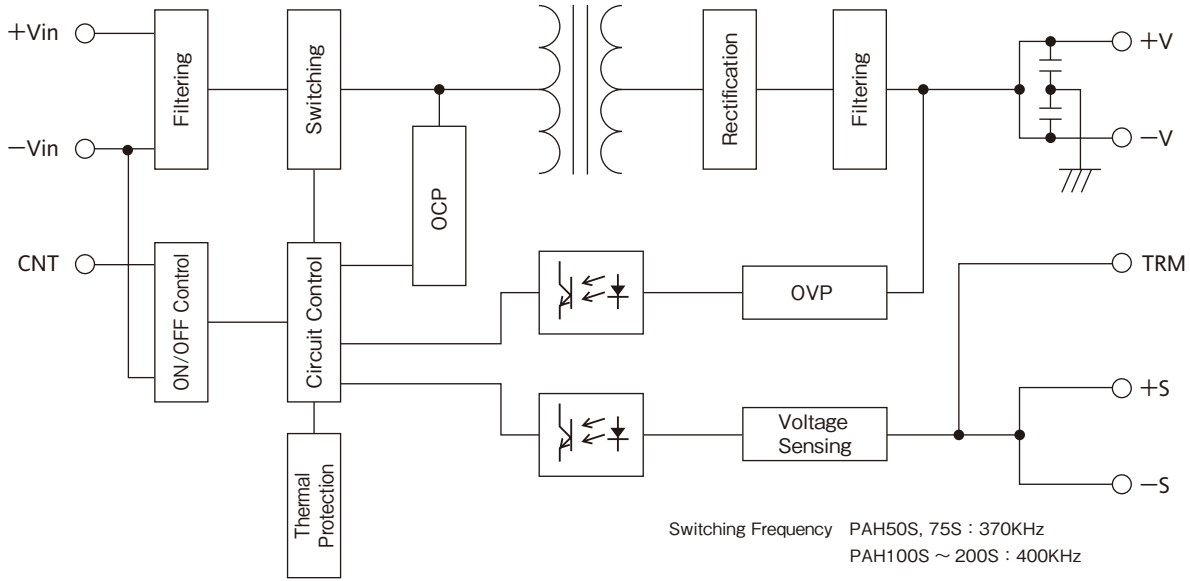

PAH

Sequence Time Chart

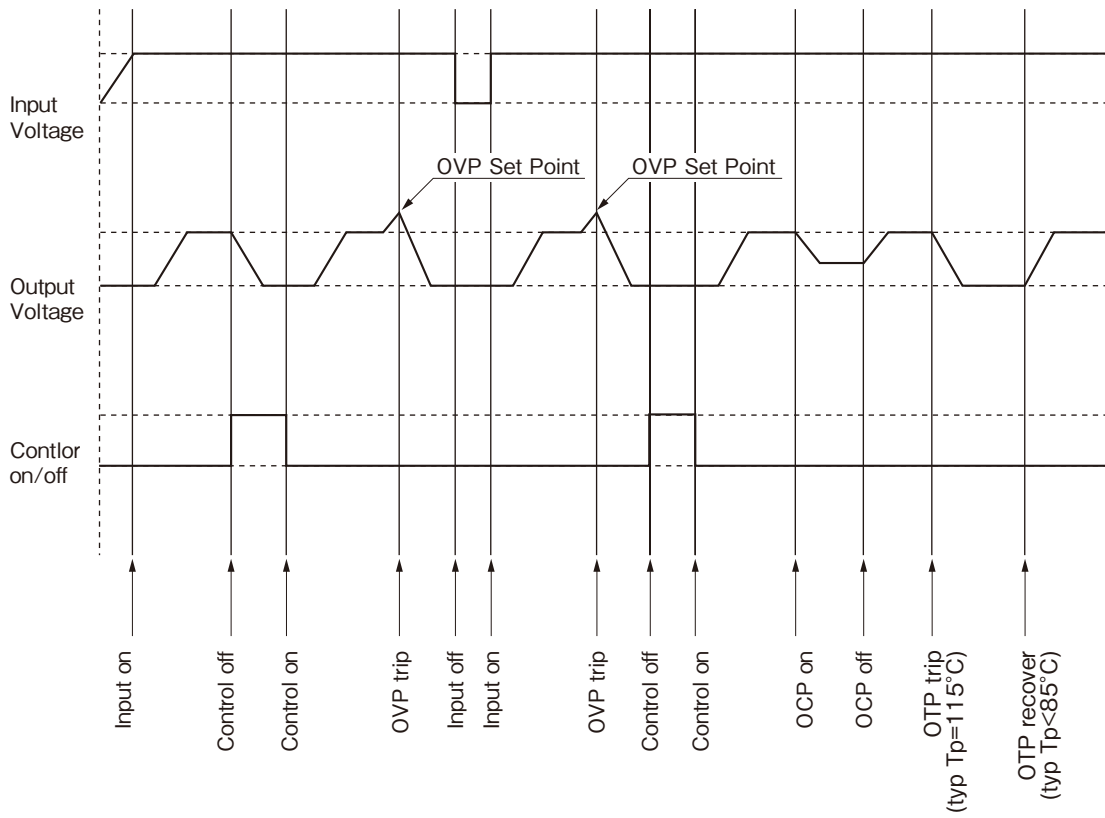

Note: This timing diagram is for negative logic "ON/OFF" option.

Block Diagram

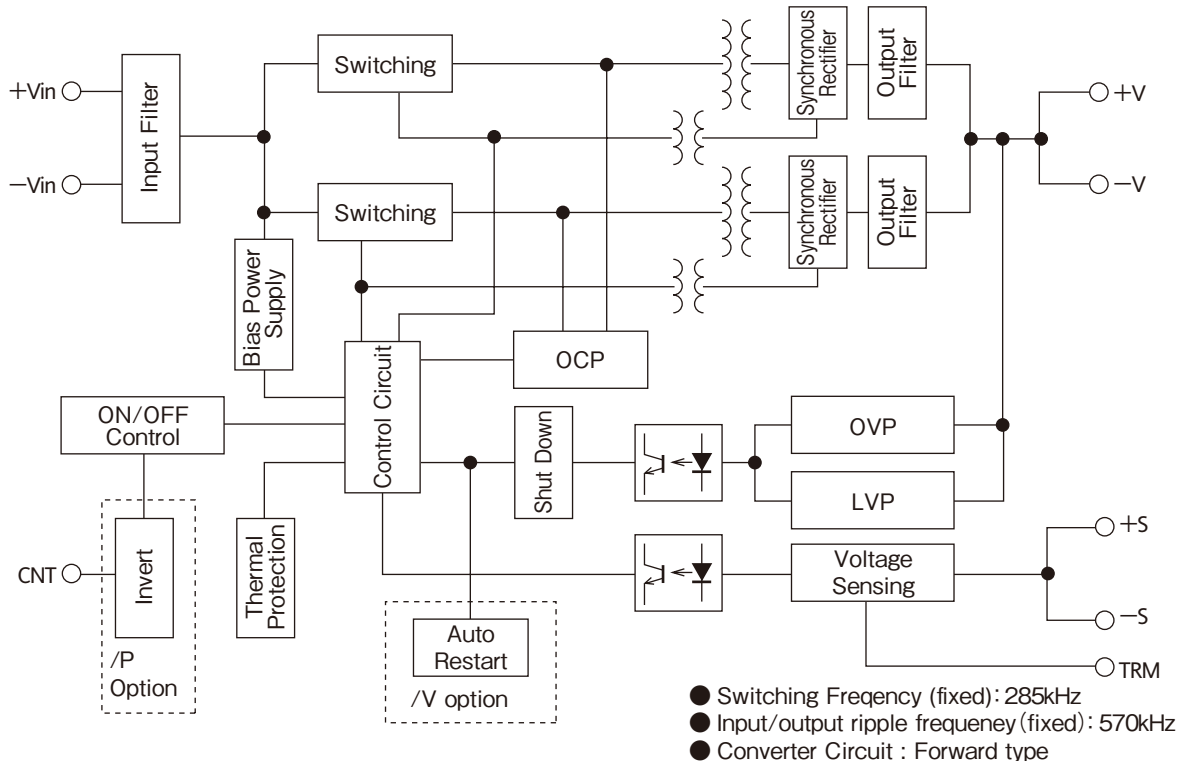

PAH



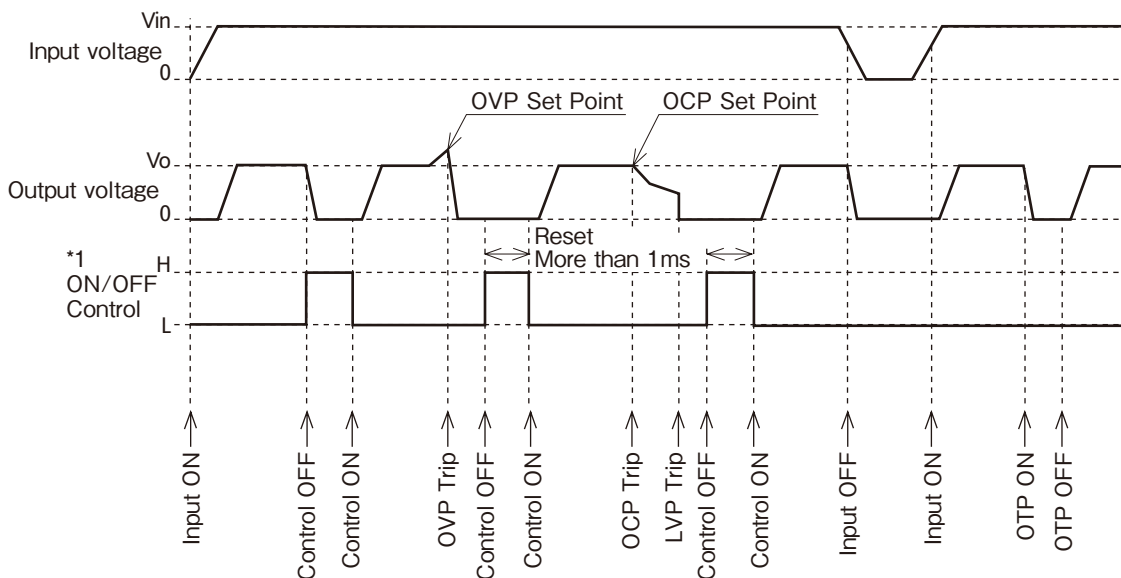

Sequence Time Chart

(For standard model with latch type OVP and OCP, negative logic for ON/OFF control)



*1 level: $4 \leq H \leq 35(V)$ or Open
 $0 \leq L \leq 0.8(V)$ or Short

PAH-S48 SERIES Instruction Manual

- PAH300S24, 350S24 Instruction Manual  B-175Page
- PAH300S48, 350S48 Instruction Manual  B-189Page
- PAH450S48 Instruction Manual  B-196Page
- PAH75D Instruction Manual  B-204Page
- PAH200H Instruction Manual  B-216Page

Before Using This Power Module

Pay attention to all warnings and cautions before using this unit. Incorrect usage could lead to an electric shock, damage to the unit, or a fire hazard. Be sure to read below warnings and cautions before using the power module.

Warning

- Do not touch heatsink and case which may be hot.
- Do not open the case and touch the internal components. They may have high temperature or high voltage which may get you in electric shock or burned.
- When the unit is operating, keep your hands and face away from the unit. You may get injured by an accident.

Caution

- Confirm connections to input/output terminals and signal terminals are correct as indicated in the instruction manual.
- Attach a fast blow type external fuse to each module to ensure safety operation and to acquire each safety standard approval.

- This power module is designed for professional installation within an end user equipment.
- Use isolated voltage by reinforced insulation at primary power supply or double insulation as input power source.
- The output from this power module must be considered as an energy hazard (> 240VA power and 2V voltage) and must not be accessible to an end user. End equipment manufacturers must provide protection against inadvertent contact with the output terminals on this product by a service engineer or by service engineer dropping a tool into them.
- The application circuits and their parameter are for reference only. Be sure to verify effectiveness of application circuits and their parameters before finalizing circuit design.
- The information in this document is subject to change without notice. For actual design-in, please refer to the latest publications of data sheet, etc., for the most up-to-date specifications of the unit.
- No part of this document may be copied or reproduced in any form or by any mean without prior written consent of Denset-Lambda.

PAH

1. Terminal Pin Configurations

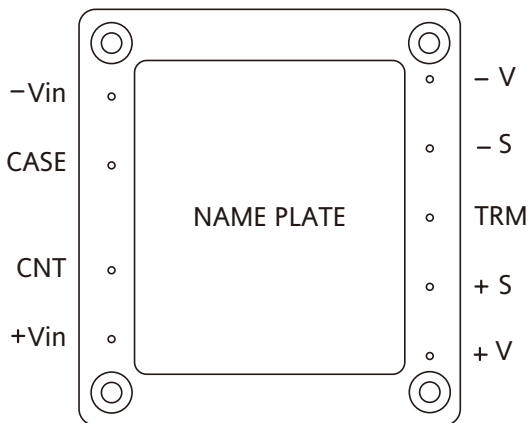

- Vin: Negative Input Terminal
- CASE: Baseplate Terminal
- CNT: ON/OFF Control Terminal
- +Vin: Positive Input Terminal
- V: Negative Output Terminal
- S: Negative Remote Sensing
- TRM: Output Voltage Adjustment Terminal
- +S: Positive Remote Sensing
- +V: Positive Output Terminal

Basic connection

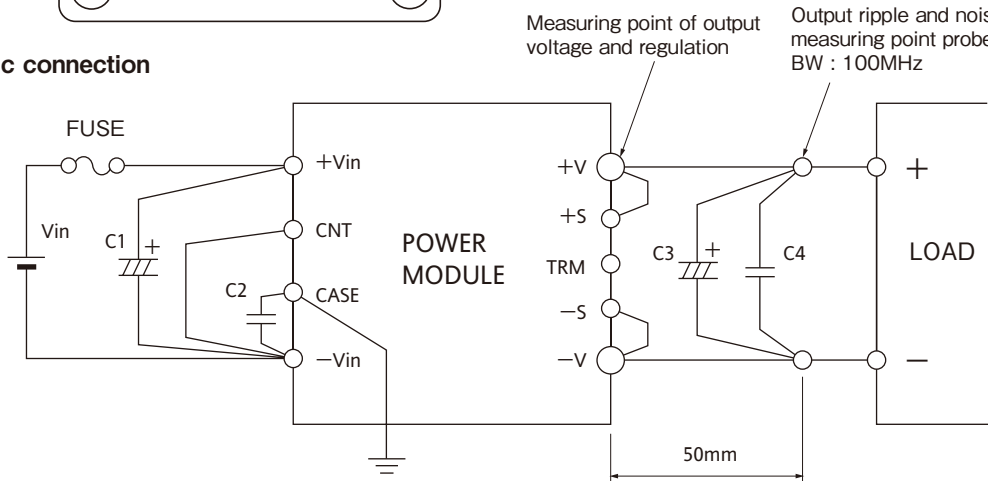

Note : This diagram is for Negative Logic "ON/OFF" Option.

1 External Components

The table below shows the recommended values for the external components above.

Item	Model	2.5	3.3	5	12	15	24	28
F1	200S				250V 15A			
	150S	250V 10A						
	100S	250V 7A						
	75S	250V 5A						
	50S	250V 5A						
			(UL approved and fast acting)					
C1*	All	Electrolytic capacitor: 100V 33uF						
C2	All	Ceramic capacitor: 2KVAC 4700pF						
C3*	200S				1000uF	1000uF	470uF	470uF
	150S	220uF	220uF	220uF	470uF	470uF	220uF	220uF
	100S							
	75S							
	50S							
C4*	All	Ceramic capacitor: 50V 1uF						

* (1) The above value is for operating temperature range from -20°C to 100°C.

- (2) For -40°C to 100°C range, change C1 to ceramic type of capacitor and use 2 capacitors for C3.
- (3) Use low ESR type E-Cap for C1 and C3 such as KME series for C1 and LXY series of Nippon Chemi-Con for C3.
- (4) Only for 200W model; -40°C to 100°C operation, C4 is increased to 10uF ceramic cap.

PAH-S48 SERIES module is not internally fused. To ensure safe operation and to receive each safety standard approval, please connect an external fuse, F1 as shown in the diagram above.

Input capacitor C1 is recommended to stabilize the module when the module is powered from a high impedance source.

Capacitor C2 is used to absorb noise coming from the module itself. This capacitor will also help the EMI performance of the module.

The function of capacitor C3 is to reduce the output ripple of the power module whereas the capacitor C4 is to reduce high frequency noise that is produced by the module.

If in any application where an input reversal connection is possible, a protective diode that is connected across +Vin and -Vin is recommended.

PAH

2. Explanations on Specifications

1 Input Voltage Range

The operating input voltage range of PAH-S48 SERIES is 36~76VDC. The maximum allowable input ripple voltage (Vrpl) is 4V. Any ripple that exceeds this value might cause the module to become unstable.

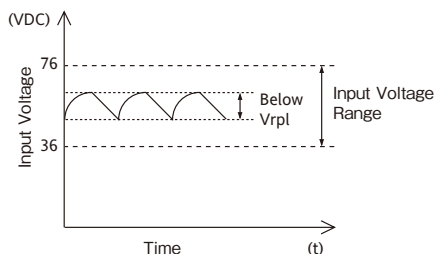

Protection for input reverse connection

Please connect protection diode and a fuse as shown below.

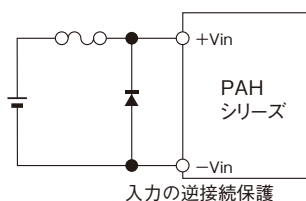

2 Output Voltage Adjust Range

The output voltage of power module can be adjusted by connecting an external resistor (R_{adj}) between the TRIM pin and either the +S or -S pins. With an external resistor (R_{adj}) between TRIM pin and -S pin, output voltage will decrease

as shown in diagram below.

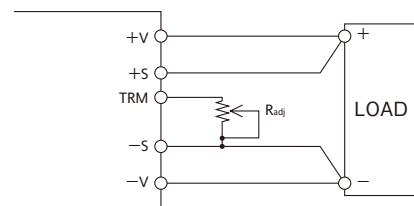

The equation shown below determines the required external resistor (R_{adj}) value to obtain a percentage output voltage change of Δ%.

$$R_{adj}(\text{down}) = \left(\frac{100\%}{\Delta\%} - 2 \right) \text{ k}\Omega$$

The graph shown below the external resistor (R_{adj}) value against a percentage output voltage change of Δ%.

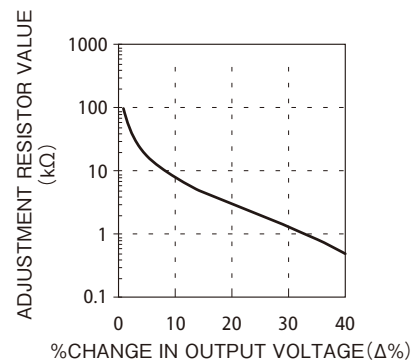

If the external resistor (R_{adj}) is connected between the TRIM pin and +S pin, the output voltage will increase. Diagram shown below is the output voltage trim up connection.

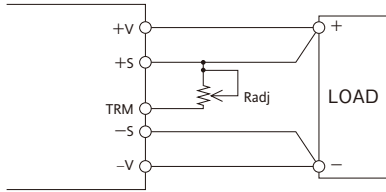

The equation shown below determines the required external resistor (R_{adj}) value to obtain a percentage output voltage change of $\Delta\%$.

$$R_{adj}(up) = \left(\frac{V_o (100\% + \Delta\%)}{1.225 \times \Delta\%} - \frac{(100\% + 2 \times \Delta\%)}{\Delta\%} \right) k\Omega$$

V_o = Nominal output Voltage.

The graph shown is the external resistor (R_{adj}) value against a percentage output voltage change of $\Delta\%$.

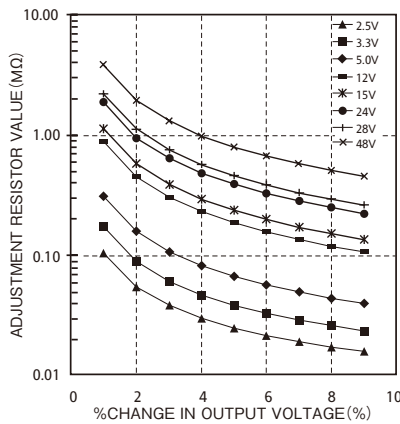

If the output voltage is raised above its nominal value, the output current needs to be derated to a value such that the output power does not exceed the maximum output power specified in the specification sheet. In addition to that, there is also a limitation to the input voltage range for the 5V version only which is as shown below.

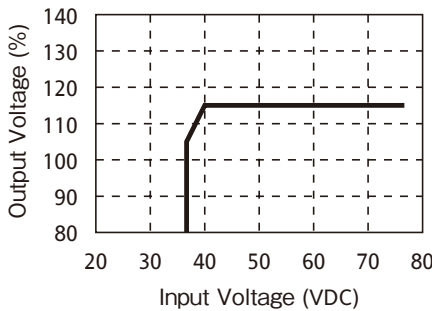

3 Output Ripple & Noise Measurement Method

The method for output ripple and noise are based upon JEITA RC-9002A. Upon measurement of the ripple voltage, make sure that the oscilloscope probe leads are not too long.

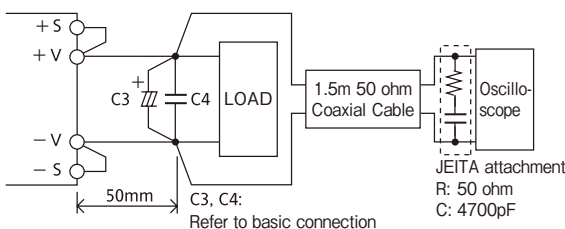

4 Maximum Line Regulation

Maximum line regulation is the maximum output voltage change when the input voltage is slowly varied within the input voltage range. The measurement point for the input and output voltage are $\pm V_{in}$ and $\pm S$ (sensing point) respectively.

5 Maximum load regulation

Maximum load regulation is the maximum output voltage value change when varying the load current slowly within the standard output current range. The measurement point for the input and output voltages are $\pm V_{in}$ and $\pm S$ (sense point) respectively.

6 Brownout

There will be output voltage overshoot during brown-out (momentary input line off) condition.

7 Over Current Protection

The PAH-S48 SERIES is equipped with an over current protection circuit. When the short or overload condition is removed, the output will automatically recover. This setting is fixed and cannot be varied externally. If the short or overload condition continues, the power module could be damaged due to the heat condition.

8 Over Voltage Protection

There are 2 types of over protection method available for the PAH series. In the standard model, a latching shutdown method is adopted. For this method there are two ways to reset the power module after OVP protection triggers. They are by (i) giving a pulse to the control pin or (ii) recycling the input voltage. In the /V optional model, the power module will shutdown after OVP protection triggers but will recover automatically when over voltage is removed.

9 Thermal Protection

The PAH-S48 SERIES have a thermal protection circuit that sense the baseplate temperature between the range of 105°C to 130°C for an over temperature condition. Under a condition where the ambient temperature or the power module internal temperature rises excessively, the thermal protection circuit will shut down the power module. The power module will recover automatically when the baseplate temperature cools down.

10 Remote Sensing

The PAH-S48 SERIES is equipped with remote sensing terminals, which compensate for the voltage drops between the power supply output terminals and the load terminals. Remote sensing should be performed at the load. When remote sensing is not required (local sensing), short the +S with the +V terminal, and the -S with the -V terminal. The

compensation range should be kept so that the output voltage is within the output voltage range and the maximum power is not exceeded. For long connections and noise sensitive environments, shielded wires are recommended to minimize noise pickup on the output leads.

Remote Sensing in Use

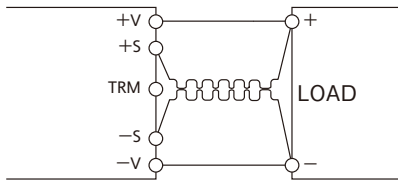

Remote Sensing not in Use

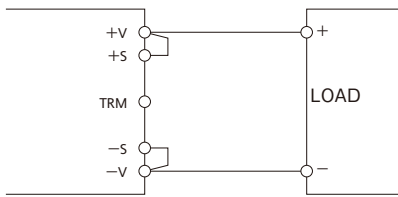

11 ON /OFF Control (CNT)

Without turning the input supply on and off, the output can be enabled and disabled using this function. This control circuit is on the input side of the power module; CNT terminal pin. There are two options available in this function, which are Negative Logic and Positive Logic. In the standard model where Negative Logic is used, the power module will turn on when CNT terminal pin is shorted to -Vin or a low logic voltage is provided. The power module will turn off when CNT pin is open or Logic high is provided. In the /P optional model where Positive logic is used, the control method is vice versa to the Negative Logic.

Below tables summarize the CNT levels and output states with different logic types.

a) Negative Logic: (Standard model)

CNT Level to -Vin	OUTPUT
H (more than 2.0V) or Open	OFF
L (less than 1.0V) or Short	ON

b) Positive Logic: (/P option)

CNT Level to -Vin	OUTPUT
H (more than 2.0V) or Open	ON
L (less than 1.0V) or Short	OFF

The maximum CNT pin voltage when it is opened is 7V. The maximum low logic sourcing current is 0.6mA. When using this function, attach a 0.1μF capacitor between the CNT and -Vin terminals.

Remote ON/OFF control can also be exercised by opening or closing the contacts of a switch or relay, or by operating a transistor as a switch in series with the CNT terminal.

Standard remote ON/OFF control circuit is provided in

the primary circuit. For secondary control, isolation can be achieved through use of an opto-coupler or relay.

CNT Connection Method

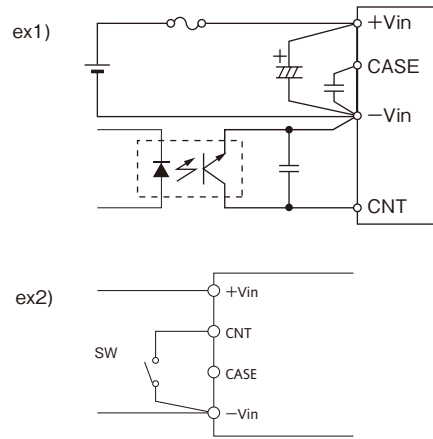

12 Series Operation

All PAH-S48 SERIES modules allow series operation with any combination of output voltages. Please contact us for maximum number of connections possible.

- (1) Series Operation for High Output Voltage Applications
When using PAH-S48 SERIES modules in a high output voltage configuration external bypassing diodes need to be connected to either module.

- a. Peak Reverse Voltage
VRRM > 2x the power module output voltage
- b. Average Output Current
Io > Twice the power module output current
- c. Forward Voltage
VF = Minimum (Schottky Barrier Type, etc)

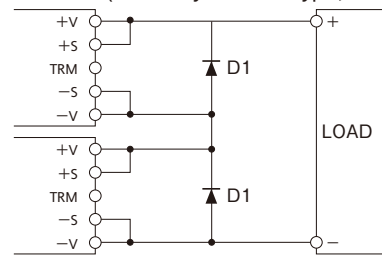

2) +/- Output Series Operation

When the load on the positive side is isolated from the load on the negative side, the following connection hookup is recommended.

Bypass diodes are not needed when operate in this mode.

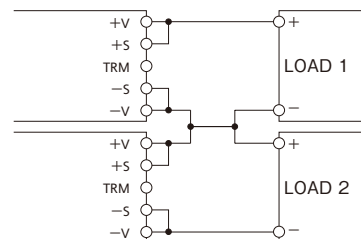

13 Operation Temperature

The baseplate temperature range for PAH-S48 SERIES is from -40°C to 100°C .

14 Operation Humidity

Avoid the buildup of condensation on or in the power module.

15 Storage Temperature

Please note that sudden temperature changes can cause condensation buildup, and other harmful affects to each terminal solder.

16 Storage Humidity

High temperature and humidity can cause the terminals on the module to oxidize. The quality of the solder will become worse.

PAH

17 Cooling Method

The operating temperature is specified by the baseplate temperature. Various cooling methods are possible such as using heatsink or chassis of the equipment. If the temperature is very high, fan is recommended.

18 Parallel Operation

PAH series are not available for parallel operation.

19 Baseplate Temperature vs. Output Regulation

This is the output voltage change ratio when varying the baseplate operation temperature.

20 Withstand Voltage

The power module is designed to withstand 1.5kVAC between the input to the baseplate and input to output for 1 minute. In the case that the withstanding voltage is tested in the incoming goods test, etc., please set the limit of the test equipment to 20mA. The applied voltage must be increased gradually from zero to the testing value, and then decreased gradually at shutdown. Do not use a timer where a pulse of several times the applied voltage can be generated. This could cause damage to the module. Be sure to short all the input and output pins as shown below.

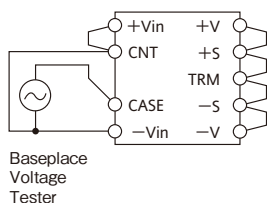

Input - Baseplate
1.5kVAC 1 min. (20mA)

Note : Please be sure to short all the input & output pins as shown above.

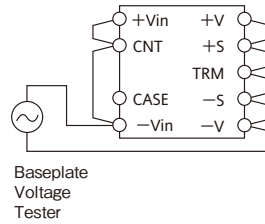

Input - Output
1.5kVAC 1 min.(20mA)

Note : Please be sure CASE is not shorted to any pins.

21 Isolation Resistance

The isolation resistance is more than 100MΩ at 500VDC when tested with a DC isolation tester between the output and the baseplate. Make sure that during testing, the isolation testers do not produce a high pulse when the applied voltage is varied. Ensure that the tester is fully discharged after the test.

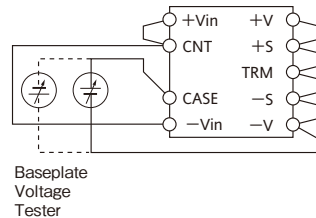

22 Vibration

Please refer to the power module mounting in the PAH-S48 series handbook in order to achieve vibration level stated in the specification.

23 Shock

Value for the conditions of our shipping and packaging.

24 Others

The performance of a system with Power Module is influenced according to various conditions -- PCBs, chassis, mechanics, heat dissipation.

Please evaluate actual products, and confirm its performance.

Please refer to "Power Module Application Note" for thermal design and mounting direction.

3. Mounting Direction

1 Circuit Board Mounting

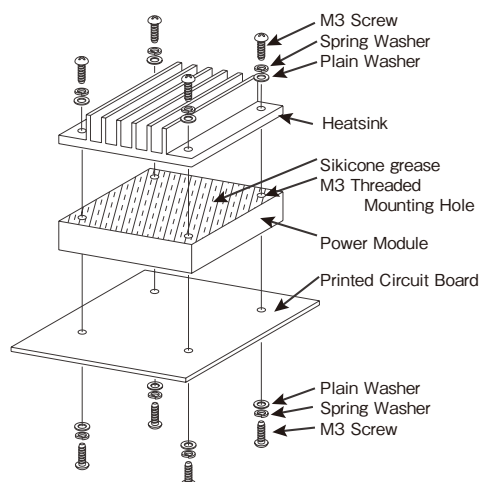

Fig.1-1 Mounting method for standard model

- (1) The power module is fixed to printed circuit board by 4 positions through the M3 tapped holes in the resin case side. Recommended torque is 5.5kgcm.
- (2) The M3 mounting tapped holes of the power module are connected to the baseplate. FG (Frame Ground) can be taken by these tapped holes.
- (3) Mounting Holes on Printed Circuit Board
 - Input/Signal/Output Terminal Pin ($\phi 1.0\text{mm}$)
 - Hole Diameter : $\phi 1.5\text{ mm}$
 - Land Diameter : $\phi 3.5\text{ mm}$
 - Output terminal Pin ($\phi 2.0\text{ mm}$)
 - Hole Diameter : $\phi 2.5\text{ mm}$
 - Land Diameter : $\phi 5.0\text{ mm}$
 - M3 Mounting Tap (FG)
 - Hole Diameter : $\phi 3.5\text{ mm}$
 - Land Diameter : $\phi 7.0\text{ mm}$
- (4) Recommended Printed Circuit Board is a double sided glass epoxy ($t=1.6\text{mm}$) with through holes.
- (5) The standard power module lead length is 5.08mm.

2 Recommended Soldering Condition

Recommended soldering temperature is as follows.

- (1) Soldering dip : 260°C within 10 seconds
Pre-heat condition : 110°C 30~40 seconds
- (2) Soldering iron : 350°C within 3 seconds

3 Recommended Cleaning Condition

Recommended cleaning condition after soldering is as follows.

- Cleaning solvent : IPA (isopropyl alcohol)
- Cleaning Procedure : Use brush and dry the solvent completely

Note : For other cleaning methods, contact us.

4 Heatsink Installation

- 1) The power module is fixed to the heatsink by 4 position through the M3 mounting tapped holes provided on the baseplate. It is recommended that the sequence to screw the 4 screws is in a diagonally manner and the recommended torque is 5.5kgcm.
- 2) Recommended hole diameter for heatsink = 3.5mm.
- 3) Use thermal grease or thermal sheet in between heatsink and baseplate to minimize the contact thermal resistance. However, make sure that the thermal grease or sheet is evenly applied and using no-warped heatsink in order to avoid any warpage on the baseplate.
- 4) Recommended thermal sheet is as shown below. Cutting the corner of thermal sheet is NOT advisable.

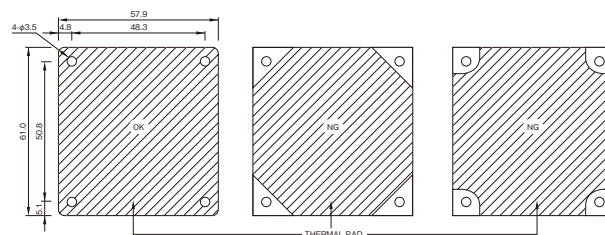

5 Output Derating

- (i) PAH50S48, PAH75S48, PAH100S48 & PAH150S48

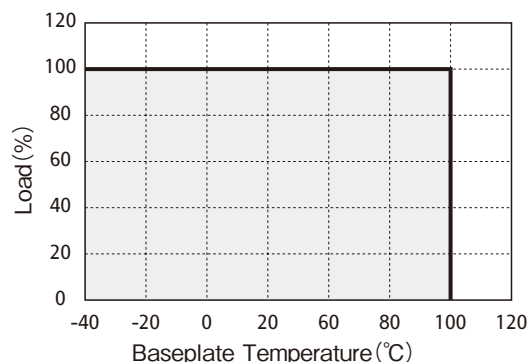

- (ii) PAH200S48

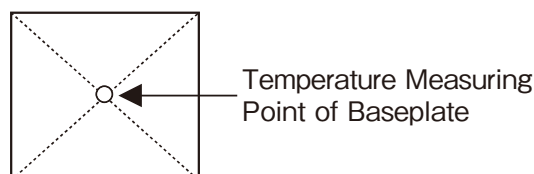
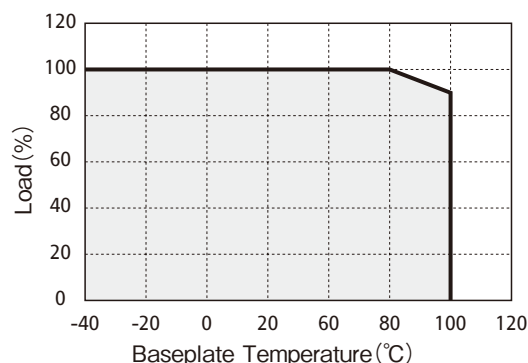





6 External Fuse Rating

Fuse rating : PAH200S48 --- 250V 15A (Fast Blow Type)
PAH150S48 --- 250V 10A (Fast Blow Type)
PAH100S48 --- 250V 7A (Fast Blow Type)
PAH75S48 --- 250V 5A (Fast Blow Type)
PAH50S48 --- 250V 5A (Fast Blow Type)

7 Notes

Over Current Protection operates > 105% of maximum DC output current.

PAH200H Instruction Manual

- PAH300S24, 350S24 Instruction Manual  B-169Page
- PAH50S48 ~ 200S48 Instruction Manual  B-177Page
- PAH300S48, 350S48 Instruction Manual  B-182Page
- PAH450S48 Instruction Manual  B-190Page
- PAH75D Instruction Manual  B-199Page

Before Using This Power Module

Be sure to take note of precautions and warnings indicated in this manual when using this product. Improper usage may lead to electric shock or fire. Be sure to read this instruction manual thoroughly before using this product.

Caution

- There are high voltage and high temperature components within this product. Refrain from disassembling this product or touching its internal components as this may lead to electric shock or burned.
- When the unit is operating, keep your hands and face away from the unit. You may get injured by accident.
- Confirm connections to input/output terminals and signal terminals are correct as indicated in the instruction manual.
- Attach a fast blow type external fuse to each module to ensure safety operation and compliance to each safety standard approval.
- This power module is designed for professional installation within the end user equipment.
- Use isolated voltage by reinforced or double insulation as

input power source.

- Do not inject abnormal voltage to output terminal and signal terminal from the outside.
The injection of reverse voltage or over voltage exceeding nominal output voltage to output terminals might cause Damage to internal output capacitor (Functional Polymerized Capacitor)
- The application circuits and their parameter are for reference only. Be sure to verify effectiveness of application circuits and their parameters before finalizing circuit design.
- The information in this document is subject to change without prior notice. For actual design-in, please refer to the latest publications of data sheet, etc., for the most up-to-date specifications of the unit.
- No part of this document may be copied or reproduced in any for, or by any mean without prior written consent of Den-sei-Lambda.

Note : CE Marking

CE Marking, when applied to a product covered by instruction manual, indicates compliance with the low voltage directive which complies with EN60950

PAH

1. Terminal Explanation

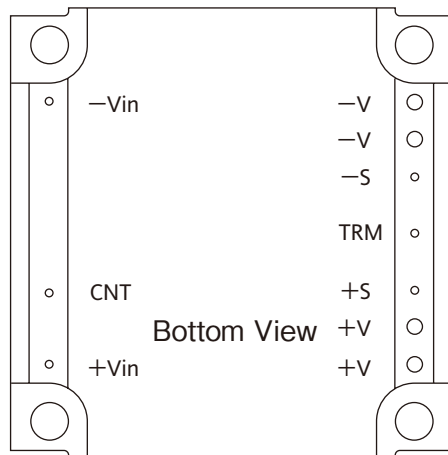

Input and Output Terminal Configurations(Bottom View)

[Input terminal]

- Vin: -Input Terminal
- CNT: ON/OFF Control Terminal
- +Vin: +Input Terminal

[Output terminal]

- V: -Output Terminal
- S: -Remote Sensing Terminal
- TRM: Output Voltage Trimming Terminal
- +S: +Remote Sensing Terminal
- +V: +Output Terminal

Please ensure good connectivity to minimize the connection resistance for terminal +Vin, -Vin, +V and -V.

2. Explanation on Specifications

1 Input Voltage Range

Input voltage Range for PAH200H48 Series is indicated below.

Input Voltage Range: 36 - 76VDC
Maximum Applied Surge Voltage:
100VDC, 100ms

Basically, ripple voltage (V_{rpl}) which results from rectification and filtering of commercial AC line is included within the input voltage as shown in Fig.1-1.

Ripple voltage must be limited within the voltage described below.

Allowable input ripple voltage: 4Vp-p

When this value is exceeded, the output ripple voltage becomes large.

Note that abrupt input voltage change may cause the output voltage to fluctuate transitionally.

Also, input voltage waveform peak value must not exceed above input voltage range.

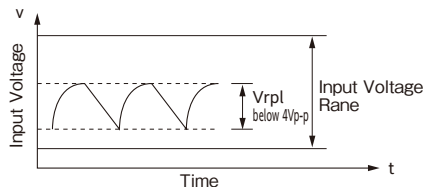

Fig.1-1 Input Ripple Voltage

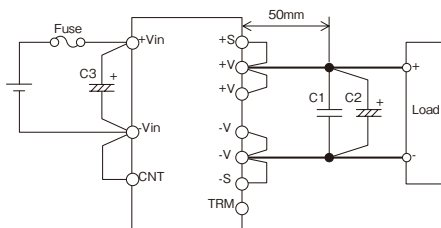

Fig.1-2 Basic Connection

(Standard Model: Negative Logic type for ON/OFF Control)
 Input Fuse

PAH200H48 Series module is not internally fused. To ensure safe operation and to receive each Safety Standard approval, please connect an external fuse (fast-blow type) as shown in Fig.1-2.

Fuse must be connected to the +Vin side if -Vin side is used as a ground, or fuse must be connected to -Vin side if +Vin side is used as a ground.

Recommended input fuse current rating:
PAH200H48: 10A

C1: 1 μ F, C2: 10 μ F

To reduce spike noise voltage at the output, connect 1 μ F ceramic capacitor and 10 μ F electrolytic capacitor or tantalum capacitor between +V and -V within 50mm distance from the output terminals.

Also, take note that output spike noise voltage could vary according to PCB wiring design.

Maximum capacitance of electrolytic capacitor that can be connected between +V and -V, is total 10,000 μ F.

C3:

Input capacitor C3 is recommended to stabilize to module when the module is powered from a high impedance source.

Select the electrolytic capacitor with low ESR and sufficient allowable ripple current.

Verify actual ripple current value by actual measurement.

Recommended capacitor value: 100 μ F and above
(voltage rating 100V or above)

Note) 1. Use low impedance electrolytic capacitor with excellent temperature characteristics.

(Nippon Chemicon LXV Series or equivalent)

2. When input line inductance becomes excessively high due to insertion of choke coil operation of the power module could become unstable. For this case, increase C3 value more than the value indicated above.
3. When ambient temperature becomes lower than -20°C , connect two capacitors indicate above in parallel

C4:

When switches or connectors are used between input source and PAH200H48 Series input terminals, impulse surge voltage is generated due to input throw-in by switch on/off or due to inserting/removing of power module from the active line. For this case, connect an additional electrolytic capacitor C4 as shown in fig.1-3 and fig.1-4.

Recommended Capacitor: 100 μ F and above
(Voltage Rating 100V or above)

Also, in-rush current flows at line throw-in.

Therefore, be sure to verify capability of switch or fuse to withstand I^2t at line throw-in.

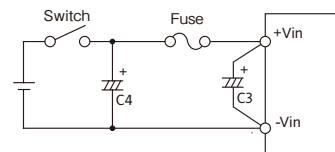

Fig.1-3 Input filter (C4) with Switch

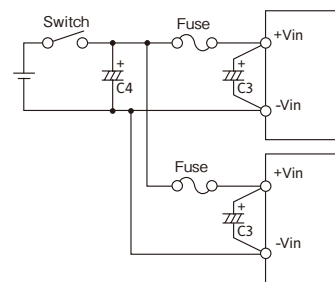

Fig.1-4 Input Filter with Switch when Plural Power

Reverse input connections

Reverse input polarity would cause module damage.

For cases where reverse connections are possible, connect a protective diode and fuse. Use protective diode with higher voltage rating than the input voltage, and with higher surge current rating than the fuse.

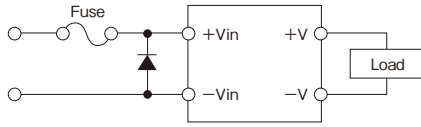

Fig.1-5 Protection for Reversed Input Connection

2 Output Voltage Adjustment Range

Output voltage could be adjusted within the range described below by external resistor or variable resistor. However, take note that OVP might trigger when output voltage adjustment exceeds the ranges indicated below.

Output Voltage Adjustment Range

3.3V: -15% - +15% of nominal output Voltage

1.8V, 2.5V: -20% - +10% of nominal output Voltage

When increasing the output voltage reduce the output current accordingly so as not to exceed the maximum output power.

For 3.3V output model, take note that when output voltage is increased, input voltage range is limited as shown in fig.2-1.

Also, when output voltage is decreased under output adjustment range, output voltage will shut off.

Remote sensing is possible even when output voltage is varied. For details on remote sensing function, please refer to "9. Remote Sensing"

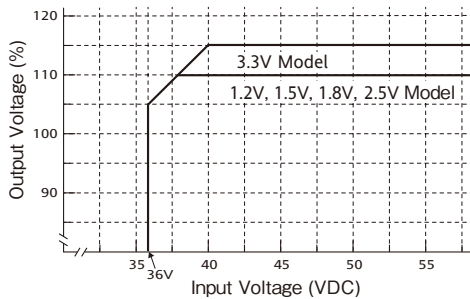

Fig.2-1 Limit of Input Voltage

Output Voltage Adjustment by external resistor or by variable resistor

(1) In case of adjusting output voltage lower

(1-1) Available maximum output current = rated output current

(1-2) Connect an external resistor R_{adj}(down) between the TRM terminal and -S terminal.

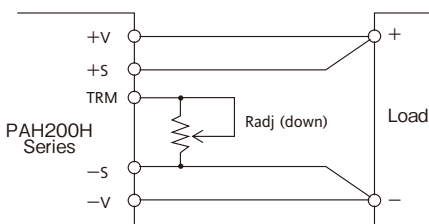

Fig.2-2 Connection for output voltage trim down (1)

(1-3) Equation of external resistor and output voltage.

(1R8, 2R5, 3R3)

$$R_{adj}(\text{down}) = \left(\frac{100\%}{\Delta\%} - 2 \right) [k\Omega]$$

(1R5)

$$R_{adj}(\text{down}) = \left(\frac{2.67 \times 100\%}{\Delta\%} - 3.67 \right) [k\Omega]$$

(1R2)

$$R_{adj}(\text{down}) = \left(\frac{1.67 \times 100\%}{\Delta\%} - 2.67 \right) [k\Omega]$$

R_{adj} (down) : Value of external resistor

Δ (%) : Output voltage change rate against nominal output voltage

Below graph is relation Δ% and value of external resistor.

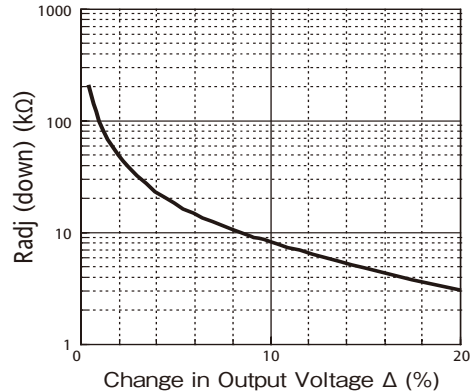

Fig.2-3 Δ (%) vs. R_{adj}(down) (1)

(2) In case of adjusting output voltage higher

(2-1) Allowable maximum output current = value of output power ÷ output voltage (reduce maximum output current in specification.)

(2-2) Connect an external resistor R_{adj} (up) between TRM terminal and +S terminal

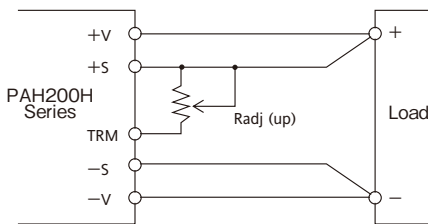

Fig.2-4 Connection for output voltage trim up (2)

(2-3) Equation of external resistor and output voltage

(1R8, 2R5, 3R3)

$$R_{adj}(\text{up}) = \left(\frac{V_o (100\% + \Delta\%)}{1.225 \times \Delta\%} - \frac{100\% + 2 \times \Delta\%}{\Delta\%} \right) [k\Omega]$$

(1R5)

$$R_{adj}(\text{up}) = \left(\frac{1.26 \times 100\%}{\Delta\%} + 0.2 \right) [k\Omega]$$

(1R2)

$$R_{adj}(\text{up}) = \left(\frac{0.78 \times 100\%}{\Delta\%} - 0.22 \right) [k\Omega]$$

V_o: nominal output value of module

R_{adj} (up) : external adjustment resistor

Δ (%) : Output voltage change rate against nominal output voltage

Ex.) To adjust to 3.63V for 3.3V nominal model, setting level is +10% , therefore Δ(%) = 10% .

Below graph is relation $\Delta(\%)$ and value of external resistor.

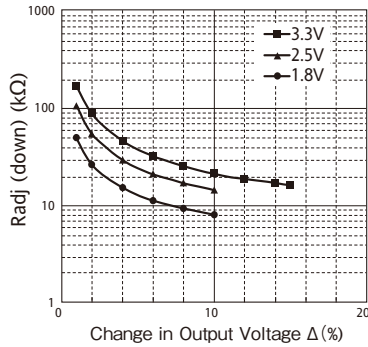

Fig.2-5 $\Delta\%$ vs.Radj (up) (2)

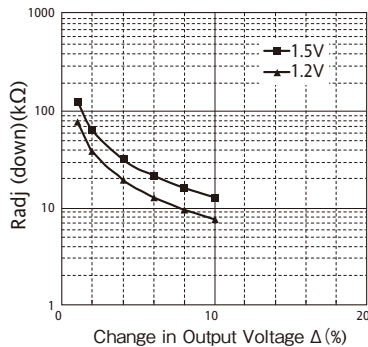

Fig.2-6 $\Delta(\%)$ vs.Radj (down) (3)

(3) To adjust output voltage for whole range Resistor values, as well as, connecting methods for external resistor (R1) and external variable resistor (VR) are described below.

	1.8V	2.5V	3.3V
R1	2.2k	1k	2.2k
VR	1k	2k	2k

unit: [Ω]

Table 2-3 Value of External Resistor and Variable Resistor

V_o -20% , +10%	(1.8V,2.5V)
V_o \pm 15%	(3.3V)

	1.8V	2.5V	3.3V
R1	5.6k	3.3k	5.6k
VR	500	1k	1k

unit: [Ω]

Table 2-4 Value of External Resistor and Variable Resistor (\pm 10% Variable)

R1: \pm 5% Tolerance
 VR: \pm 20% Tolerance
 with end resistance below 1%

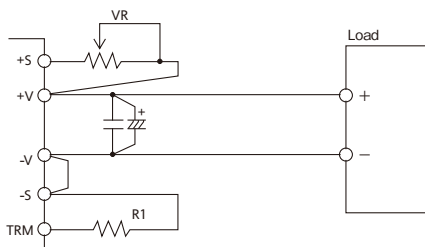

Fig.2-6 Example connection of external resistor

3 Maximum Ripple and Noise

(1) Measurement based on JEITA RC-9141
 Measure according to the specified methods (Fig.3-1) based on JEITA RC-9141(Clause 7.12 and 7.13) which is described in the following. Connect capacitors (C1: ceramic capacitor $1\mu\text{F}$, C2: tantalum capacitor $10\mu\text{F}$) at 50mm distance from the output terminals. Measure at ceramic capacitor (C1) leads as shown in fig.3-1 using coaxial cable with JEITA attachment. Use oscilloscope with 100MHz frequency bandwidth or equivalent.

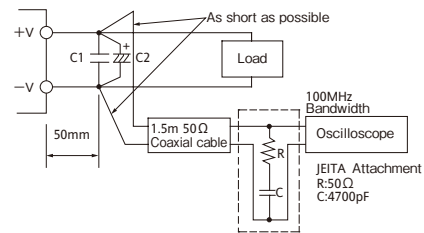

Fig.3-1 Measurement of Maximum Output Ripple & Noise Based on JEITA RC-9141

(2) Measurement using coaxial cable
 Measure according to Fig.3-2. Connect capacitors (C1: ceramic capacitor $1\mu\text{F}$, C2: tantalum capacitor $10\mu\text{F}$) at 50mm distance from the output terminals. Measure at ceramic capacitor (C1) leads using coaxial cable. Use oscilloscope with 20MHz frequency bandwidth or equivalent.

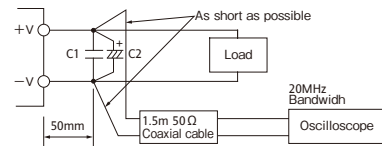

Fig.3-2 Measurement of Maximum Output Ripple & Noise Using coaxial cable

Take note that output ripple voltage and output spike noise may vary depending on PCB wiring design. Generally output ripple voltage and output spike noise can be reduced by increasing value of external capacitor.

4 Maximum Line Regulation

Maximum line regulation is the maximum value of output voltage change when input voltage is gradually varied within specified input voltage range. The measurement point for the input and output voltage are $\pm V_{in}$ and $\pm S$ (sense point) respectively.

5 Maximum Load Regulation

Maximum value of output voltage change when output current is gradually varied within specified output current range. The measurement point for the input and output voltage are $\pm V_{in}$ and $\pm S$ (sense point) respectively. When using at dynamic load mode, audible noise may be heard from the power module and output voltage fluctuation might increase.

6 Over Current Protection (OCP)

This power module has built-in OCP function. Output will recover when short circuit or overload conditions are released. OCP setting value is fixed and therefore, can not be externally adjusted. Also, take note, when

output voltage drops down below lower side of adjustment range for 20ms - 50ms by output short circuit or over load conditions, output might be shut down.

Output can be recovered by manual reset of the control ON/OFF terminal or by turning input line off and then turning it on again.

7 Over Voltage Protection (OVP)

This power module has built-in OVP function. OVP set point is relative to the rated output voltage value. When output voltage exceeds OVP set point, output voltage shuts down. OVP set point is fixed and therefore can not be changed. When OVP is triggered, output can be recovered by turning input line off and then turning it on again after lowering the input voltage below the voltage value indicated below or by manual reset of the control ON/OFF terminal.

Input voltage for OVP reset: 24VDC and below

/V Option (automatic recovery)

The /V optional model will re-start with delay of 100ms ~ 400ms after shutdown by OCP or OVP triggering. When over voltage and over current are removed, output will recover normally.

Verifying OVP function shall be done by increasing output voltage with external resistor. For verifying OVP function, avoid applying external voltage to output terminal because this will cause power module damage.

8 Over Thermal Protection (OTP)

This power module has built-in OTP function. This function operates and shuts down the output when temperature of the power module rises abnormally. Take note that OTP will operate again unless the cause of abnormal heat of the power module is eliminated.

For the details of OTP, refer to the clause of "Mounting Method and Thermal Condition"

9 Remote Sensing (+S, -S Terminal)

Remote sensing terminal is provided to compensate for voltage drop across the wiring from the power module output terminal to the load input terminal.

When remote sensing function is not used (local sensing), short +S terminal to +V terminal and, -S terminal to -V terminal.

Fig.9-1 indicates connections when the remote sensing terminal is used. For optimum operations, connect electrolytic capacitor as large capacity as possible (within 10,000µF) between +V and -V terminal, as well as across the load terminals. Take note that voltage compensation range for line drop (voltage drop due to wiring) should be kept such that output voltage at the output terminals is within output voltage range and the maximum power doesn't exceed Use shielded wire, twist pair, or parallel pattern to reduce noise effect. When the remote sensing terminal is used, if the load wiring impedance is large, output power may disrupt the stability. To reduce the load wiring impedance, wiring should be thick and short as much

as possible. When using the lead wiring, the wire should be twist pair, or when using the pattern, use the pattern layout as shown in fig.9-3 to reduce the impedance as small as possible.

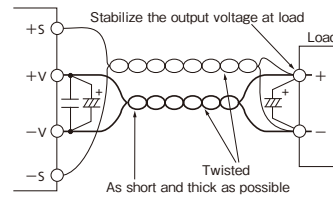

Fig.9-1 Remote Sensing in Use

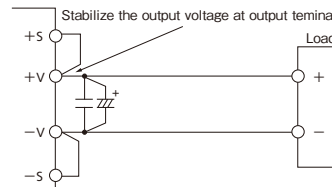

Fig.9-2 Remote Sensing Not in Use (Local Sensing)

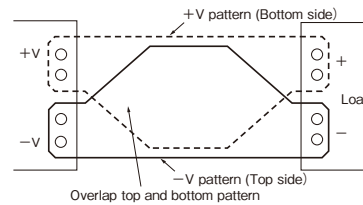

Fig.9-3 Example of Load Wiring Pattern Layout in using the double-sided PCB

10 ON/OFF Control (CNT Terminal)

Without turning the input supply on and off, the output can be enabled and disabled using this function. This function also can be used for output sequence of plural modules. There are two kind of logic control, negative logic control and positive logic control, depend on the option selected. ON/OFF control circuit is on the primary side (the input side), CNT Terminal pin. For secondary control, isolation can be achieved through the use of a opto coupler or relay.

	Logic	CNT Terminal Level to -Vin Terminal	Output status
Standard	Negative Logic	H Level (4V ≤ H ≤ 35V) or Open	OFF
[/V option]		L Level (0V ≤ H ≤ 0.8V) or Short	ON
[/P option]	Positive Logic	H Level (4V ≤ H ≤ 35V) or Open	ON
[/PV option]		L Level (0V ≤ H ≤ 0.8V) or Short	OFF

*When control function is not used for the Standard, CNT terminal is shorted to -Vin terminal.

*When using long wiring, for prevention of noise, attach a 0.1µF capacitor between CNT Terminal and -Vin terminal.

*At L level, maximum source current from CNT terminal to -Vin terminal is 0.5mA

*The maximum CNT Terminal voltage is 35V.

(1) Output ON/OFF control

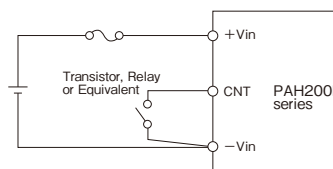

(2) Secondary (output side) control

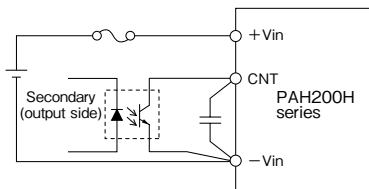

Fig.10-1 CNT Connection

11 Parallel Operation

Parallel Operation can not be used.

12 Series Operation

Series Operation is possible for PAH200H Series. For the number of maximum series connection, please contact us

(A) Series Operation in High Output Voltage

When Series Operation is used to obtain Higher Output Voltage, a bypass diode is needed to prevent the reverse voltage (refer Fig12-1.) The selection guide for this bypass diode is described below :

Condition of selection, bypass diode D1, D2

1. Peak Repeated Reverse Voltage
 $VRRM \geq$ duplicate of nominal output voltage of the power supply.
2. Average output current
 $I_o \geq$ duplicate of nominal output current of the power supply.
3. Forward voltage
 $V_F \geq$ The lowest
 (schottky barrier diode and equivalent)

Output reverse maximum applied voltage: 0.6VDC and below

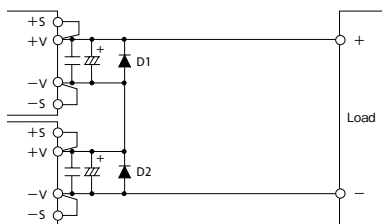

Fig.12-1 Series Operation for High Output Voltage

(B) ± Output Series Operation

When +load and -load is completely separated the bypass diode is not required.

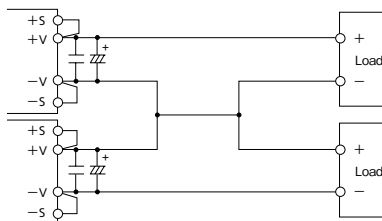

Fig.12-2 ± Output Series Operation

13 Operating Ambient Temperature

According to ambient temperature, output load should derated accordingly (refer to Mounting Method & Terminal Condition). There is no restriction on mounting direction

but there should be enough consideration for airflow so that heat does not accumulate around the power module vicinity.

Determine external components configuration and mounting direction on PCB such that air could flow through power module at forced air cooling or convection cooling. For better reliability, derating of ambient temperature is recommended. For details on derating, refer to "Mounting Method & Thermal Condition".

14 Operatin Ambient Humidity

Take note that moisture could lead to power module abnormal operation or damage.

15 Storage Ambient Temperature

Abrupt temperature change would cause condensation built-up that leads to poor solderability of terminals of the power supply.

16 Storage Ambient Humidity

High temperature and humidity can cause the terminals on the module to oxidize. The quality of the solder will become worse.

17 Cooling Method

Forced air cooling is recommended. Convection cooling is also possible. For the details of derating, refer to "Mounting Method and Thermal condition"

18 Ambient Temperature vs. Output Voltage Drift

Temperature coefficient is defined as the rate of voltage change when ambient temperature is changed during operation.

19 Withstand Voltage

This power module is designed to have a withstand voltage of 1.5kVDC between input and output. When conducting withstand voltage test during incoming inspection, be sure to apply DC voltage. Also, set the current limit value of the withstand voltage testing equipment to 10mA. Be sure to avoid conducting test with AC voltage because this would cause power module damage. Furthermore, avoid throw in or shut off of the testing equipment when applying or when shutting down the test voltage. Instead, gradually increase or decrease the applied voltage. Take note especially not to use the timer of the test equipment because when the timer switches the applied voltage off, impulse voltage which has several times the magnitude of the applied voltage is generated causing damage to the power module. Short the output side as shown in fig.19-1.

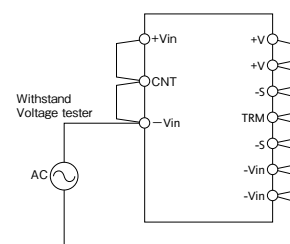

1.5kVAC 1minute (20mA)

Fig.19-1 Withstand Voltage Test for Input-Output

20 Insulation Resistance

Use DC insulation tester (MAX 500V) between output and input. Insulation resistance value is 100MΩ and above at 500VDC applied voltage. Make sure that during testing, the isolation testers does not produce a high pulse when the applied voltage is varied. Ensure that the tester is fully discharged after the test.

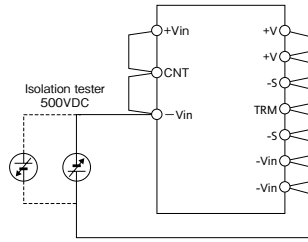

100M Ω and above at 500VDC
Fig.20-1 Isolated test

21 Vibration

Vibration of power module is defined in case of mounting on PCB.

23 Shock

Value for the conditions of out shipping and packing.

3. Mounting Method and Thermal Condition

1 Output Derating

(1) Output Derating by ambient temperature

There is no restriction on mounting direction but there should be enough consideration for airflow so that heat does not accumulate around the power module vicinity. Determine external components configuration and mounting direction on PCB such that air could flow through power module at forced air cooling or convection cooling. Take note, output power derating is needed as shown in followings. The derating curves provided is based on the below set-up condition.

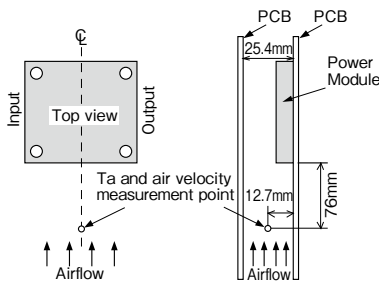

Fig.1-1 Output derating set-up condition

Fig. 1-2, 1-3, and 1-4 shows output derating vs ambient temperature.

In this case, natural convection cooling means occurrence of 0.2m/s airflow due to self heating of the power module. If the product is used out of derating curve, they shut down by OTP (over temperature protection).

Please note that OTP cannot operate correctly when cooling is concentrated on thermal detector only

Output derating by ambient temperature

Vin=48VDC at standard vertical mounting

PAH200H48-1R8 (include /P, /V, /PV option)

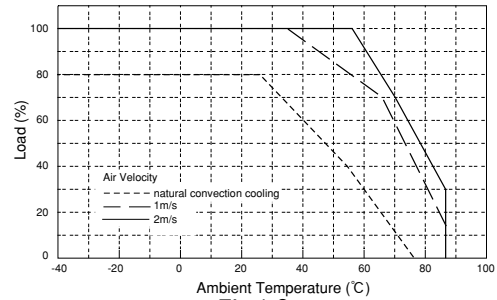

Fig.1-2

PAH200H48-2R5 (include /P, /V, /PV option)

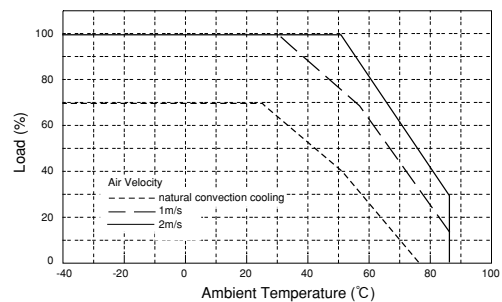

Fig.1-3

PAH200H48-3R3 (include /P, /V, /PV option)

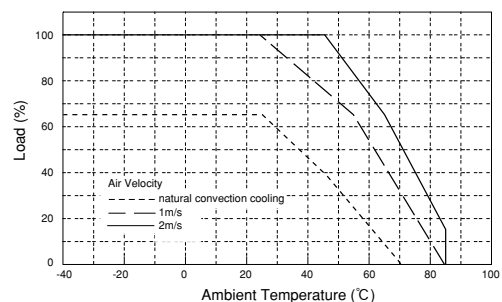

Fig.1-4

(2) Output derating by PCB

When use with different measurement conditions from output derating by ambient temperature, use output derating by PCB temperature as in Fig.1-6.

PCB temperature is decided by temperature of thermal sensor in below Fig.1-5. As the thermal sensor terminals are exposed, when connecting thermocouple, please take sufficient insulation from terminals. Over Thermal Protection of power module is achieved by detecting the PCB temperature through thermal sensor. When the module operates over the output derating curve of PCB temperature, Over Thermal Protection (OTP) functions and output shut-down.

Therefore, measurement of PCB temperature is recommended to ensure the module to operate within the derating curve.

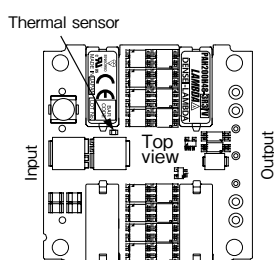

Fig.1-5 Thermal Sensor Position

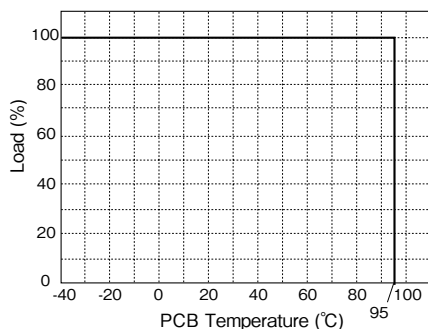

Fig.1-6 Output Derating by PCB Temperature

2 Mounting Method

(1) Mounting hole on PCB

Diameter of hole and land of PCB with referring below.

Type	PAH200H48
Input Terminal Pin	φ 1.0mm
Hole Diameter	φ 1.5mm
Land Diameter	φ 3.0mm
Output Terminal Pin	φ 2.0mm
Hole Diameter	φ 2.5mm
Land Diameter	φ 4.5mm
Signal Terminal Pin	φ 1.0mm
Hole Diameter	φ 1.5mm
Land Diameter	φ 3.0mm

For position of the holes, see outline drawing of the power module.

(2) Output Terminal Pin

Connect +V, -V terminal pins such that the contact resistance becomes minimal. Note that large contact resistance could result into reduction of efficiency and abnormal temperature rise at terminal connections

(3) Output Pattern Width

Large output current flows through the output pattern. If pattern is too narrow, voltage drop will occur and heat on pattern will increase. Relationship of current and the pattern width varies depending on materials of printed circuit board, conductor width, maximum allowable temperature rise of the pattern etc.. Confirmation on manufactures of printed circuit board is definitely necessary for designing.

3 Recommended Soldering Method

- (1) Soldering dip
260°C within 6 seconds
Pre-heat condition
110°C 30 - 40 seconds
- (2) Soldering iron
350°C within 3 seconds

4 Recommended Cleaning Condition

Recommended cleaning condition after soldering is as follows.

- Cleaning solvent
IPA (isopropyl alcohol)
- Cleaning Procedure
Use brush and dry the solvent completely.

Note) For other cleaning methods, contact us.

3. Before concluding power module damage

Verify following items before concluding power module damage.

1) No output voltage

- Is specified input voltage applied?
- Are the ON/OFF control terminal (CNT terminal), remote sensing terminal (+S,-S), output voltage trimming terminal (TRM) correctly connected?
- For cases where output voltage adjustment is used, is the resistor or variable resistor setting, connections correctly done?
- Are there no abnormalities in the output load used?
- Is the ambient temperature within the specified temperature derating curve?

2) Output voltage is high.

- Are the remote sensing terminals (+S, -S) correctly connected?
- Is the measurement done at the sensing points?
- For cases where output voltage adjustment is used, is the resistor or volume setting, connections correctly done?

3) Output voltage is low

- Is specified input voltage applied?
- Are the remote sensing terminals (+S, -S) correctly connected?
- Is the measurement done at the sensing points?
- For cases where output voltage adjustment is used, is the resistor or variable resistor setting, connections correctly done?
- Are there no abnormalities in the output load used?

4) Load regulation and line regulation is large

- Is specified input voltage applied?
- Are the input terminals and the output terminals firmly connected?
- Is the measurement done at the sensing points?
- Is the input or output wire too thin?

5) Output ripple voltage is large

- Is the measuring method used the same or equivalent with the specified method in the Application Notes?
- Is the input ripple voltage value within the specified value?

X-ON Electronics

Largest Supplier of Electrical and Electronic Components

Click to view similar products for [Isolated DC/DC Converters](#) category:

Click to view products by [TDK-Lambda](#) manufacturer:

Other Similar products are found below :

[ESM6D044440C05AAQ](#) [FMD15.24G](#) [PSL486-7LR](#) [Q48T30020-NBB0](#) [JAHW100Y1](#) [SPB05C-12](#) [SQ24S15033-PS0S](#) [18952](#) [19-130041](#)
[CE-1003](#) [CE-1004](#) [GQ2541-7R](#) [RDS180245](#) [MAU228](#) [J80-0041NL](#) [DFC15U48D15](#) [XGS-0512](#) [XGS-1205](#) [XGS-1212](#) [XGS-2412](#) [XGS-](#)
[2415](#) [XKS-1215](#) [06322](#) [NCT1000N040R050B](#) [SPB05B-15](#) [SPB05C-15](#) [L-DA20](#) [DCG40-5G](#) [QME48T40033-PGB0](#) [XKS-2415](#) [XKS-2412](#)
[XKS-2405](#) [XKS-1212](#) [XKS-1205](#) [XKS-0515](#) [XKS-0505](#) [XGS-2405](#) [XGS-1215](#) [XGS-0515](#) [PS9Z-6RM4](#) [73-551-5038I](#) [AK1601-9RT](#) [VI-](#)
[R5022-EXWW](#) [PSC128-7iR](#) [RPS8-350ATX-XE](#) [DAS1004812](#) [VI-LJ11-iz](#) [PQA30-D24-S24-DH](#) [VI-M5F-CQ](#) [VI-LN2-EW](#)