

PAQ SERIES

DC/DC 1/8 Brick 50-100W

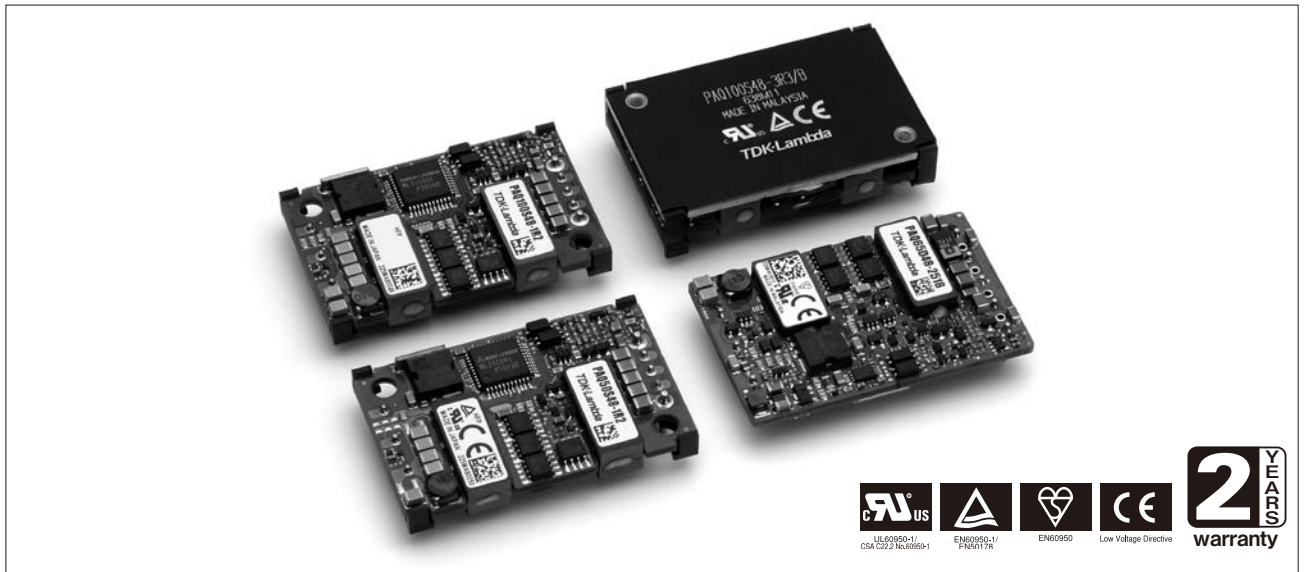

Features

- 1/4 brick industry standard size (36.8×8.5×57.9 mm)
- Compact/slim/high power density: 90.1W/inch³ (PAQ100S48-5)
- High efficiency: 90% (5V output type)
- No use of heat sink
- Output voltage adjustable type
- Internal capacitor: Functional polymer electrolytic (output smoothing), ceramic

Model naming method

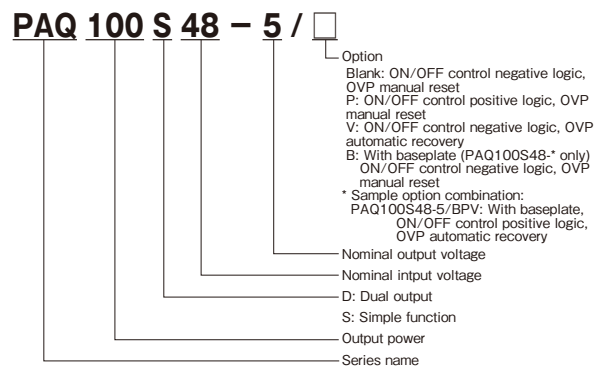

PAQ

Applications



Conformity to RoHS Directive

This means that, in conformity with EU Directive 2002/95/EC, lead, cadmium, mercury, hexavalent chromium, and specific bromine-based flame retardants, PBB and PBDE, have not been used, except for exempted applications.

Product Line up

PAQ-S (Single Output)

Output Voltage	50W			100W	
	Output Current	Model		Output Current	Model
1.2V	12A	PAQ50S48-1R2		25A	PAQ100S48-1R2
1.8V		PAQ50S48-1R8			PAQ100S48-1R8
2.5V		PAQ50S48-2R5			PAQ100S48-2R5
3.3V		PAQ50S48-3R3			PAQ100S48-3R3
5V	10A	PAQ50S48-5		20A	PAQ100S48-5

PAQ65D (Dual Output)

Output Voltage	65W							
	Output Current / Model		Output Current / Model		Output Current / Model		Output Current / Model	
1.8V	17A	PAQ65 D48-2518	17A	PAQ65 D48-3318	—	PAQ65 D48-3325	—	PAQ65 D48-5033
2.5V	15A		—		17A		—	
3.3V	—		15A		15A		16A	
5V	—	—	—	—	13A	—	—	

PAQ50S48-* Specifications

ITEMS/UNITS		MODEL	PAQ50S48-1R2	PAQ50S48-1R8	PAQ50S48-2R5	PAQ50S48-3R3	PAQ50S48-5
Input	Voltage Range	V	DC36 - 76				
	Efficiency (typ)	(*1) %	78	83	85	88	90
	Current (typ)	(*1) A	0.39	0.56	0.75	0.96	1.18
Output	Nominal Voltage	VDC	1.2	1.8	2.5	3.3	5
	Maximum Current	A	12				10
	Maximum Power	W	14.4	21.6	30	39.6	50
	Voltage Setting Accuracy	(*1) %	±1				
	Maximum Line Regulation	(*2) mV	10				
	Maximum Load Regulation	(*3) mV	10				
	Temperature Coefficient		Less than 0.02%/°C				
	Maximum Ripple & Noise	(*8) mVp-p	100				
Function	Voltage Adjustable Range	(*8)	-20%, +10%			±15%	
	Over Current Protection	(*4)	105% - 150% (Option available : Refer to option table)				
	Over Voltage Protection	(*5)	120% - 140% (Option available : Refer to option table)				
	Remote Sensing	(*6)	Possible				
	Remote ON/OFF Control		Possible (Option available : Refer to option table)				
	Parallel Operation	(*6)	-				
	Series Operation	(*6)	Possible				
Environment	Operating Temperature	(*7) °C	Ta= -40 to +85				
	Storage Temperature	°C	-40 to +100				
	Operating Humidity	%RH	5 - 95 (No dewdrop)				
	Storage Humidity	%RH	5 - 95 (No dewdrop)				
	Vibration		At no operating, 10-55Hz (sweep for 1min.) Amplitude 0.825mm constant (maximum 49.0m/s ²) X, Y, Z 1 hour each				
	Shock		196.1m/s ²				
Isolation	Cooling	(*7)	Convection cooled / Forced air cooled				
	Withstand Voltage		Input-Output : 1.5kVDC for 1min				
	Isolation Resistance		More than 100MΩ at 25°C and 70%RH Input-Output...500VDC				
Standards	Safety Standards		Approved by UL60950-1, CSA 22.2 No.60950-1, EN60950-1				
Mechanical	Weight (typ)	g	50				
	Size (W x H x D)	mm	36.8 x 8.5 x 57.9 (Refer to outline drawing)				

- (*1) At 48VDC, maximum output current, air velocity = 2m/s and Ta = +25°C.
- (*2) 36 - 76VDC, constant load.
- (*3) No load - full load, constant input voltage.
- (*4) Constant current limiting. (The unit automatically shutdown when left in OCP condition with the output voltage less than the LVP level.) Auto restart option available.
- (*5) Inverter shutdown method, manual reset. Auto restart option available.
- (*6) Refer to Instruction manual.
- (*7) Refer to derating curve and instruction manual.
- (*8) External components are needed for operation. (Refer to basic connection and Instruction manual.)

Basic Connection

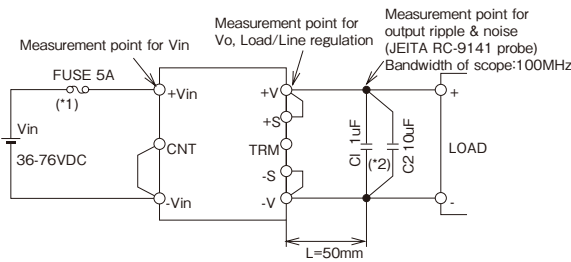

- (*1) Use an external fuse (fast blow type) for each unit.
- (*2) Put output capacitors.
C1: 1µF ceramic capacitor.
C2: 10µF tantalum capacitor or electrolytic capacitor.
- (*3) Refer to instruction manual for further details.

Option Table

Option	OVP, OCP	Remote ON/OFF control
Standard	Shut down (ON/OFF control reset or manual reset)	Negative (Short : ON, Open : OFF)
/V	Auto restart	
/P	Shut down (ON/OFF control reset or manual reset)	Positive (Short : OFF, Open : ON)
/PV	Auto restart	

Outline Drawing

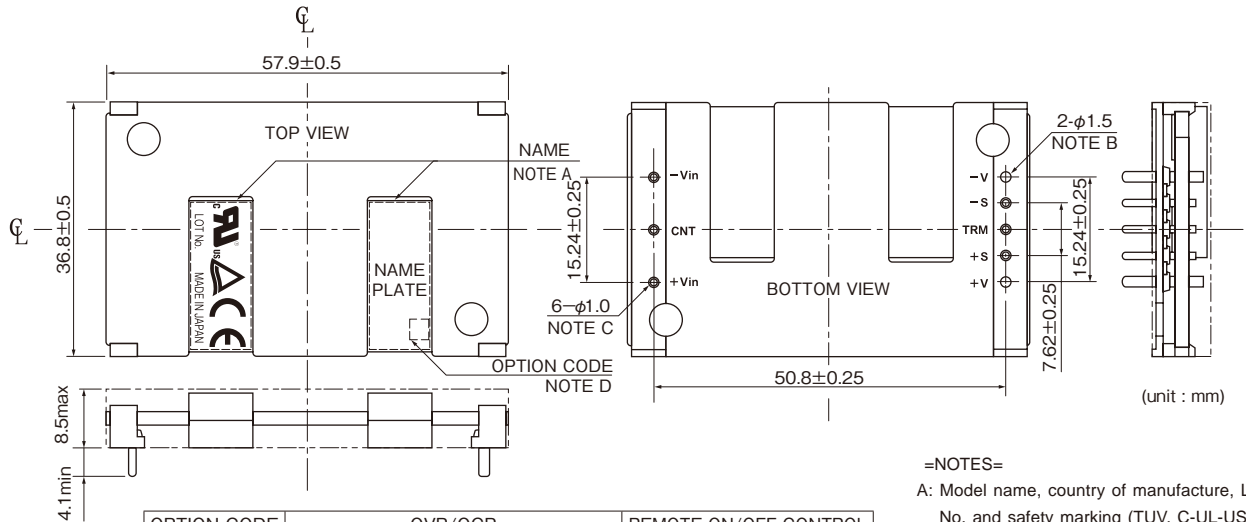

OPTION CODE	OVP/OCP	REMOTE ON/OFF CONTROL
NOTHING (STANDARD)	SHUT DOWN (ON/OFF CONT. RESET OR MANUAL RESET)	NEGATIVE (SHORT: ON OPEN: OFF)
/V	AUTO RESTART	
/P	SHUT DOWN (ON/OFF CONT. RESET OR MANUAL RESET)	POSITIVE (SHORT : OFF OPEN : ON)
/PV	AUTO RESTART	

=NOTES=
 A: Model name, country of manufacture, Lot No. and safety marking (TUV, C-UL-US & CE marking) are shown here in accordance with the specifications.
 B: Output pin of +V and -V : 2- φ 1.5
 C: Signal and Input pin : 6- φ 1
 D: OPTION

Derating Curve

Vin=48Vdc
PAQ50S48-1R2

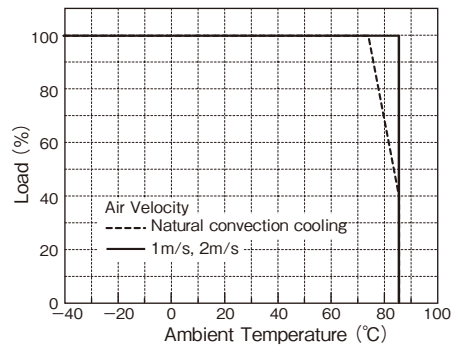

PAQ50S48-1R8

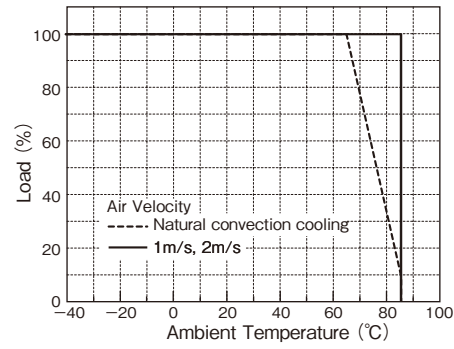

PAQ50S48-2R5

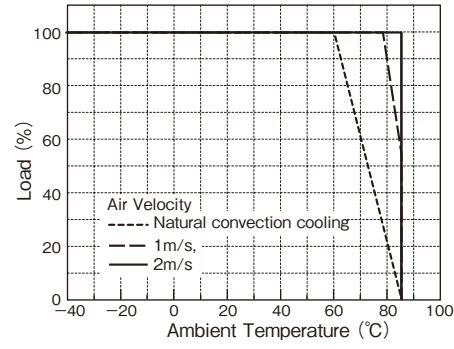

PAQ50S48-3R3

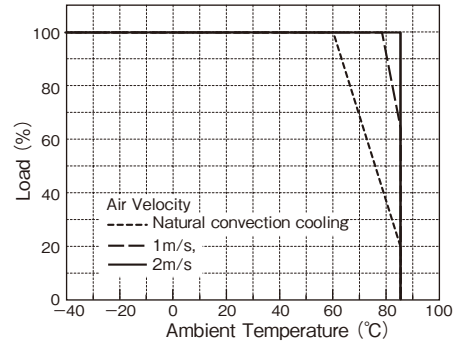

PAQ50S48-5

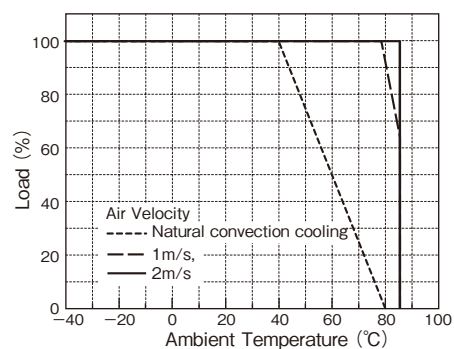

AIRFLOW DIRECTION FOR STANDARD VERTICAL MOUNTING

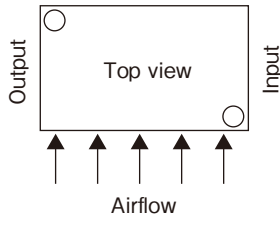

NOTES
 *For other mounting methods, airflow directions and conditions, refer to Instruction manual.

• All specifications are subject to change without notice.

PAQ100S48-* Specifications

ITEMS/UNITS		MODEL	PAQ100S48-1R2	PAQ100S48-1R8	PAQ100S48-2R5	PAQ100S48-3R3	PAQ100S48-5
Input	Voltage Range	V	DC36 - 76				
	Efficiency (typ)	(*1) %	80	84	86	89	90
	Current (typ)	(*1) A	0.8	1.14	1.55	1.98	2.37
Output	Nominal Voltage	VDC	1.2	1.8	2.5	3.3	5
	Maximum Current	A	25				20
	Maximum Power	W	30	45	62.5	82.5	100
	Voltage Setting Accuracy	(*1) %	±1				
	Maximum Line Regulation	(*2) mV	10				
	Maximum Load Regulation	(*3) mV	10				
	Temperature Coefficient		Less than 0.02%/°C				
	Maximum Ripple & Noise	(*8) mVp-p	100				
Function	Voltage Adjustable Range	(*8)	-20%, +10%			±15%	
	Over Current Protection	(*4)	105% - 140% (Option available : Refer to option table)				
	Over Voltage Protection	(*5)	120% - 140% (Option available : Refer to option table)				
	Remote Sensing	(*6)	Possible				
	Remote ON/OFF Control		Possible (Option available : Refer to option table)				
	Parallel Operation	(*6)	-				
	Series Operation	(*6)	Possible				
Environment	Operating Temperature	(*7) °C	Ta= -40 to +85				
	Storage Temperature	°C	-40 to +100				
	Operating Humidity	%RH	5 - 95 (No dewdrop)				
	Storage Humidity	%RH	5 - 95 (No dewdrop)				
	Vibration		At no operating, 10-55Hz (sweep for 1min.) Amplitude 0.825mm constant (maximum 49.0m/s ²) X, Y, Z 1 hour each				
	Shock		196.1m/s ²				
Isolation	Cooling	(*7)	Convection cooled / Forced air cooled				
	Withstand Voltage		Input-Output : 1.5kVDC for 1min				
	Isolation Resistance		More than 100MΩ at 25°C and 70%RH Input-Output...500VDC				
Standards	Safety Standards		Approved by UL60950-1, CSA 22.2 No.60950-1, EN60950-1				
Mechanical	Weight (typ)	g	50				
	Size (W x H x D)	mm	36.8×8.5×57.9 (Refer to outline drawing)				

- (*1) At 48VDC, maximum output current, air velocity = 2m/s and Ta = +25°C.
- (*2) 36 - 76VDC, constant load.
- (*3) No load - full load, constant input voltage.
- (*4) Constant current limiting. (The unit automatically shutdown when left in OCP condition with the output voltage less than the LVP level.) Auto restart option available.
- (*5) Inverter shutdown method, manual reset. Auto restart option available.
- (*6) Refer to Instruction manual.
- (*7) Refer to derating curve and Instruction manual.
- (*8) External components are needed for operation. (Refer to basic connection and Instruction manual.)

Basic Connection

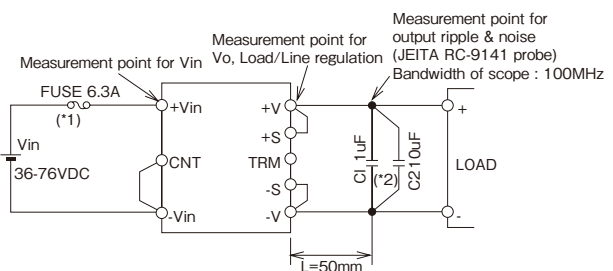

- (*1) Use an external fuse (fast blow type) for each unit.
- (*2) Put output capacitors.
C1: 1μF ceramic capacitor.
C2: 10μF tantalum capacitor or electrolytic capacitor.
- (*3) Refer to instruction manual for further details.

Option Table

Option	OVP, OCP	Remote ON/OFF control
Standard	Shut down (ON/OFF control reset or manual reset)	Negative (Short : ON, Open : OFF)
/V	Auto restart	
/P	Shut down (ON/OFF control reset or manual reset)	Positive (Short : OFF, Open : ON)
/PV	Auto restart	

Outline Drawing

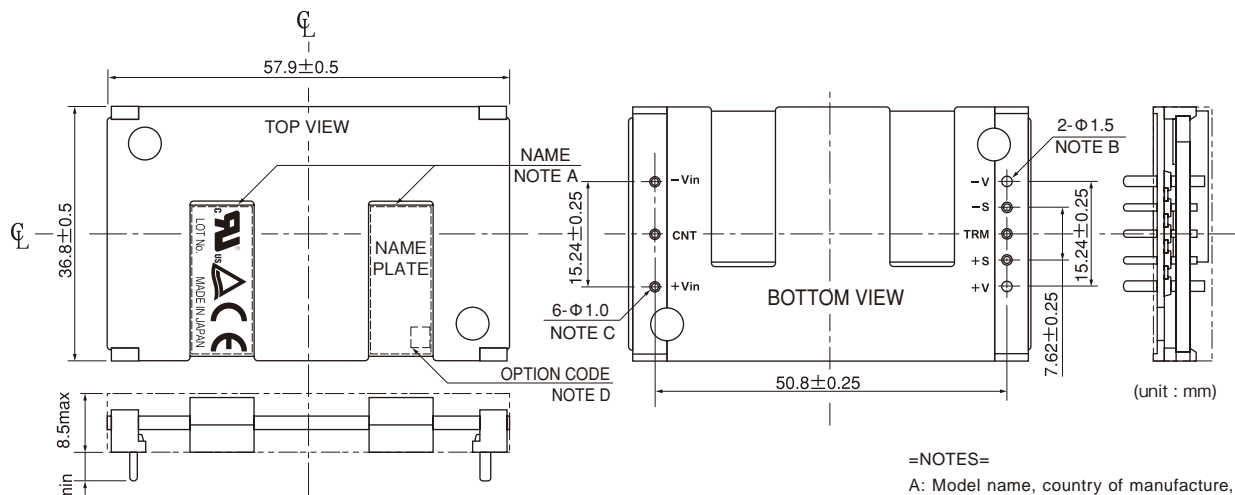

OPTION CODE	OVP/OCP	REMOTE ON/OFF CONTROL
NOTHING (STANDARD)	SHUT DOWN (ON/OFF CONT. RESET OR MANUAL RESET)	NEGATIVE (SHORT : ON OPEN : OFF)
/V	AUTO RESTART	
/P	SHUT DOWN (ON/OFF CONT. RESET OR MANUAL RESET)	POSITIVE (SHORT : OFF OPEN : ON)
/PV	AUTO RESTART	

=NOTES=
 A: Model name, country of manufacture, Lot No. and safety marking (TUV, C-UL-US & CE marking) are shown here in accordance with the specifications.
 B: Output pin of +V and -V : 2- Φ 1.5
 C: Signal and Input pin : 6- Φ 1
 D: OPTION

Derating Curve

Vin = 48VDC
 PAQ100S48-1R2

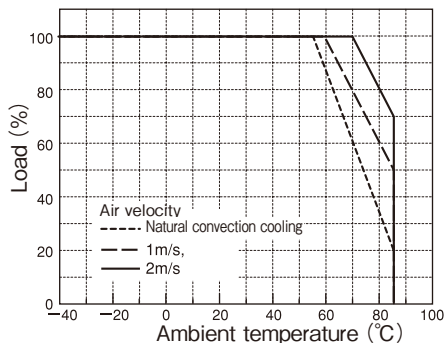

PAQ100S48-1R8

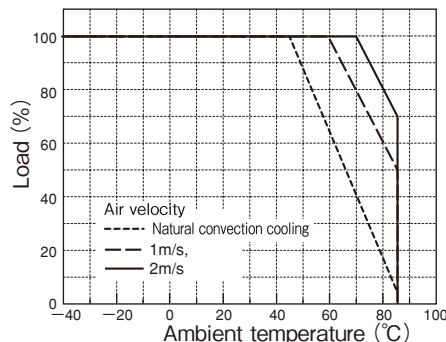

PAQ100S48-2R5

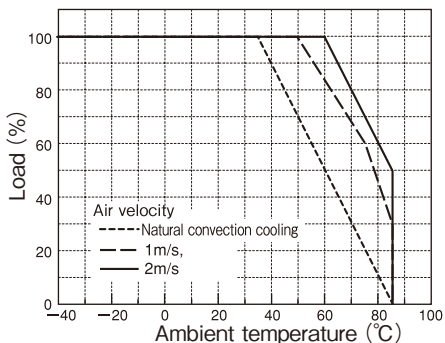

PAQ100S48-3R3

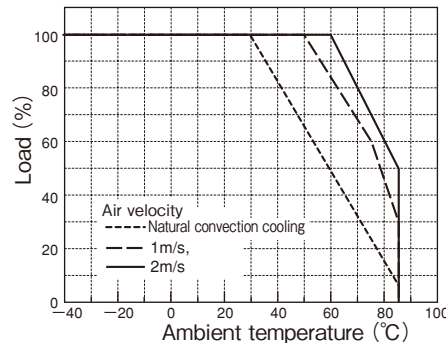

PAQ100S48-5

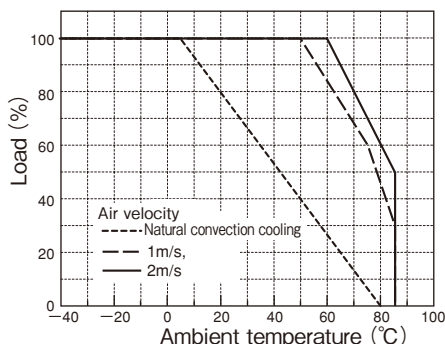

AIRFLOW DIRECTION FOR STANDARD VERTICAL MOUNTING

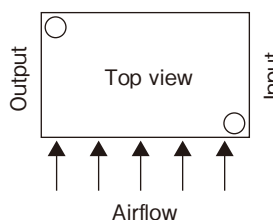

NOTES
 *For other mounting methods, airflow directions and conditions, refer to Instruction manual.

PAQ100S48-*/B Specifications

ITEMS/UNITS		MODEL	PAQ100S48-1R2/B	PAQ100S48-1R8/B	PAQ100S48-2R5/B	PAQ100S48-3R3/B	PAQ100S48-5/B	
Input	Voltage Range	V	DC36 - 76					
	Efficiency (typ)	(*1) %	80	84	86	89	90	
	Current (typ)	(*1) A	0.8	1.14	1.55	1.98	2.37	
Output	Nominal Voltage	VDC	1.2	1.8	2.5	3.3	5	
	Maximum Current	A	25					20
	Maximum Power	W	30	45	62.5	82.5	100	
	Voltage Setting Accuracy	(*1) %	±1					
	Maximum Line Regulation	(*2) mV	10					
	Maximum Load Regulation	(*3) mV	10					
	Temperature Coefficient		Less than 0.02%/°C					
	Maximum Ripple & Noise	(*8) mVp-p	100					
Function	Voltage Adjustable Range	(*8)	-20%, +10%			±15%		
	Over Current Protection	(*4)	105% - 140% (Option available : Refer to option table)					
	Over Voltage Protection	(*5)	120% - 140% (Option available : Refer to option table)					
	Remote Sensing	(*6)	Possible					
	Remote ON/OFF Control		Possible (Option available : Refer to option table)					
	Parallel Operation	(*6)	-					
Environment	Series Operation	(*6)	Possible					
	Operating Temperature	(*7) °C	Baseplate : -40 to +100 / MIN ambient temperature : -40					
	Storage Temperature	°C	-40 to +100					
	Operating Humidity	%RH	5 - 95 (No dewdrop)					
	Storage Humidity	%RH	5 - 95 (No dewdrop)					
	Vibration		At no operating, 10-55Hz (sweep for 1min.) Amplitude 0.825mm constant (maximum 49.0m/s ²) X, Y, Z 1 hour each					
	Shock		196.1m/s ²					
Isolation	Cooling	(*7)	Conduction cooled / Forced air cooled					
	Withstand Voltage		Input-Baseplate : 1.5kVDC, Input-Output : 1.5kVDC for 1min Output-Baseplate : 500VDC for 1min					
	Isolation Resistance		More than 100MΩ at 25°C and 70%RH Output-Baseplate...500VDC					
Standards	Safety Standards		Approved by UL60950-1, CSA 22.2 No.60950-1, EN60950-1					
	Weight (typ)	g	75					
Mechanical	Size (W x H x D)	mm	36.8 x 12.7 x 57.9 (Refer to outline drawing)					

(*1) At 48VDC, maximum output current, baseplate temperature = +25°C.

(*2) 36 - 76VDC, constant load.

(*3) No load - full load, constant input voltage.

(*4) Constant current limiting. (The unit automatically shutdown when left in OCP condition with the output voltage less than the LVP level.) Auto restart option available.

(*5) Inverter shutdown method, manual reset. Auto restart option available.

(*6) Refer to Instruction manual.

(*7) Refer to derating curve on the Right and Instruction manual.

(*8) External components are needed for operation. (Refer to basic connection and Instruction manual.)

Basic Connection

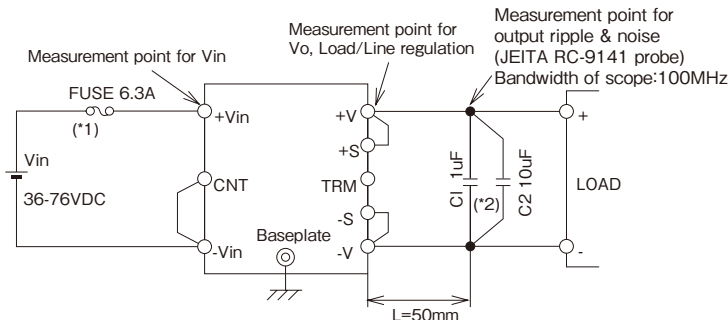

(*1) Use an external fuse (fast blow type) for each unit.

(*2) Put output capacitors.

C1: 1µF ceramic capacitor.

C2: 10µF tantalum capacitor or electrolytic capacitor.

(*3) Refer to instruction manual for further details.

Option Table

Option	OVP, OCP	Remote ON/OFF control
/B	Shut down (ON/OFF control reset or manual reset)	Negative (Short : ON, Open : OFF)
/BV	Auto restart	
/BP	Shut down (ON/OFF control reset or manual reset)	Positive (Short : OFF, Open : ON)
/BPV	Auto restart	

Outline Drawing

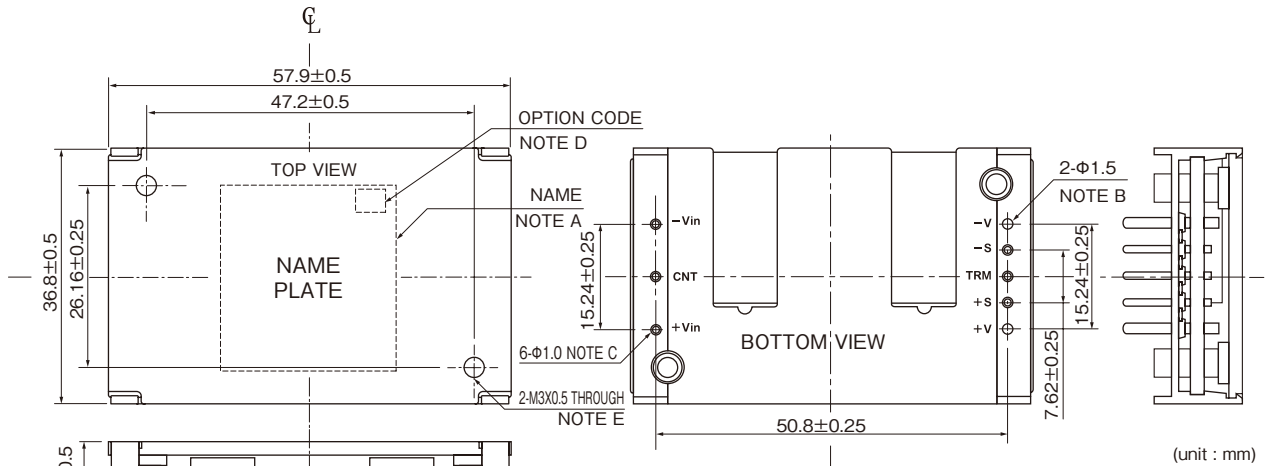

- = NOTE =
- A: Model name, country of manufacture, Lot No. and safety marking (TUV, C-UL-US & CE marking) are shown here in accordance with the specifications.
 - B: Output pin of +V and -V : 2-Φ1.5
 - C: Signal and Input pin : 6-Φ1.0
 - D: OPTION CODE

CODE	OVP/OC	REMOTE ON/OFF CONTROL
/B	SHUT DOWN (ON/OFF CONT. RESET OR MANUAL RESET)	NEGATIVE (SHORT : ON OPEN : OFF)
/BV	AUTO RESTART	
/BP	SHUT DOWN (ON/OFF CONT. RESET OR MANUAL RESET)	POSITIVE (SHORT : OFF OPEN : ON)
/BPV	AUTO RESTART	

E: M3X0.5 tapped holes 2 for customer chassis mounting (FG).

PAQ

Derating Curve

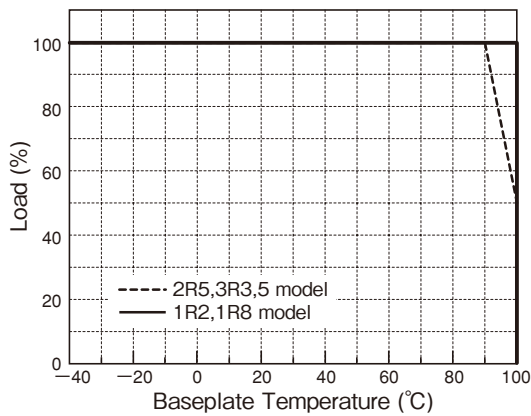

There is no restriction on mounting direction but there should be enough consideration for airflow so that heat does not accumulate around the power module vicinity. Determine external components configuration and mounting direction on PCB such that air could flow through power module at forced air cooling or convection cooling.

By maintaining baseplate temperature below 100°C, operation is possible. According to the models, output derating is needed.

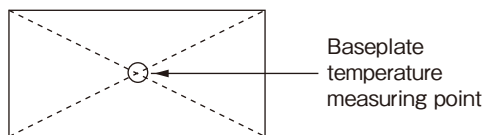

Measure baseplate temperature at center of baseplate.
For better improvement of power module reliability, more derating of baseplate temperature when using is recommended.

PAQ65D48 Specifications

ITEMS/UNITS	MODEL	PAQ65D48-2518		PAQ65D48-3318		PAQ65D48-3325		PAQ65D48-5033	
	CH	1	2	1	2	1	2	1	2
Input	Voltage Range	36 - 76 VDC							
	Efficiency (Typ) (*2)	86.0				87.0		90.0	
	Current (Typ) (*2)	0.82		0.97		1.10		1.36	
Output	Nominal Voltage	2.5	1.8	3.3	1.8	3.3	2.5	5	3.3
	Minimum Current	0							
	Maximum Current	15	17	15	17	15	17	13	16
	Maximum Current Combination	Io1+Io2 = 18A							
	Total Allowable Power (*1)	Po1+Po2 = 37.5		Po1+Po2 = 49.5		Po1+Po2 = 65			
	Voltage Setting Accuracy (*2)	± 2							
	Maximum Line Regulation (*5)	±6.6				±10		±6.6	
	Maximum Load Regulation (*6)	±16.5				±25		±16.5	
	Temperature Coefficient	0.02%/°C							
	Maximum Ripple & Noise (*4)	75	100	75	100	75	100	100	
Voltage Adjustable Range (*3)	±10%								
Function	Over Current Protection (Io1+Io2) (*7)(*8)(*10)	105 ~ 160% Current limiting with inverter shutdown (Option available : Refer to option table)							
	Over Voltage Protection (*7)(*8)	120 ~ 140% Inverter shutdown (Option available : Refer to option table)							
	Remote ON/OFF Control (*8)	Negative logic (Option available : Refer to option table)							
	Parallel Operation	-----							
	Series Operation	-----							
Environment	Operating Temperature	-40 to +85							
	Storage Temperature	-40 to +100							
	Operating Humidity	5 ~ 95 (No dewdrop)							
	Storage Humidity	5 ~ 95 (No dewdrop)							
	Vibration	At no operating, 10 - 55Hz (sweep for 1 min.) Amplitude 0.825mm constant (maximum 49.0 m/s ²) X,Y,Z 1 hour each							
	Shock	196.1 m/s ² (In package)							
Isolation	Cooling (*8)(*9)	Convection cooling / forced air cooling with derating							
	Withstand Voltage	Input - Output : 1.5kVDC for 1 min.							
Standards	Isolation Resistance	More than 100Mohm at 25°C and 70 %RH, Input - Output : 500 VDC							
	Safety Standards	Approved by UL60950-1, CSA 22.2 No.60950-1, EN60950							
Mechanical	Weight (Typ)	40							
	Size (W x H x D)	36.8 x 8.9 x 57.9 (Refer to outline drawing)							

(*1) Maximum allowable combination output power for both channel; also maximum output current for each channel and combination output current for both channel should not exceeded.

(*2) At 48 VDC, ambient temperature = +25°C and air velocity = 2m/S; 5033: Io1 = Io2 = 7.5A; 3325, 3318, 2518: Io1 = Io2 = 8.5A.

(*3) Additional external components have to be connected; Both outputs are trim independantly; Refer to application notes.

(*4) Measured at Ta = 25°C, Vin = 48VDC and with external components connected; refer to basical connection drawing. For all temperature range, please refer to the application notes.

(*5) 36 ~ 76 VDC with respect to nominal input line 48V; constant load; ambient temperature = +25°C.

(*6) No load ~ full load with respect to 50% of maximum load; other output: no load; constant input voltage; ambient temperature =+25°C.

(*7) CNT reset or manual reset. Auto-restart option available.

(*8) Refer to application notes.

(*9) Refer to output derating curve.

(*10) Percentage is with respect to maximum combination current which is 18A.

Basic Connection

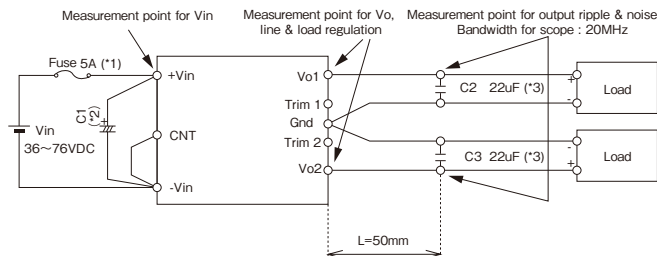

(*1) Use external fuse (fast blow type) for each unit.

(*2) Recommended input capacitor C1
 -20°C to +85°C: 33µF electrolytic type capacitor.
 -40°C to +85°C: 33µF ceramic capacitor or equivalent such as 5 parallel 6.8µF ceramic type capacitor.

(*3) 22µF ceramic capacitor

Option Table

Option :	ON/OFF Logic	OVP/OCP
Standard	Negative	Shut-down
/P	Positive	Shut-down
/V	Negative	Auto-restart
/PV	Positive	Auto-restart

Example : PAQ65D48-3325/PV; Represent positive logic, OVP/OCP Auto-restart

Option for "/C" (/C, /CP, /CV, /CPV)	Each output voltage can be varied simultaneously and by the same proportion by one trimmer.
---	---

Outline Drawing

● Standard, /P, /V, /PV

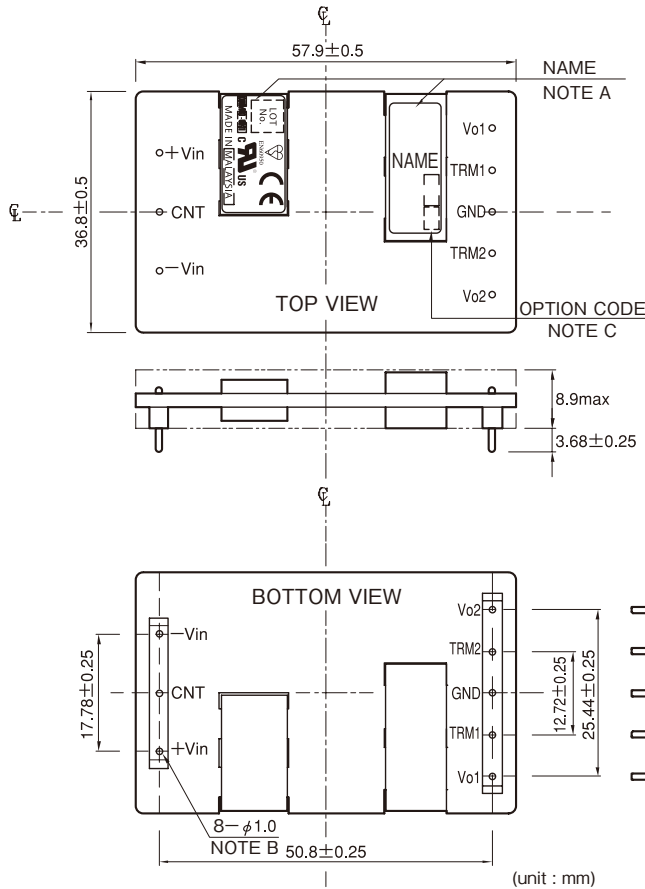

=NOTE=

A: MODEL NAME, COUNTRY OF MANUFACTURE, LOT NO. AND SAFETY MARKING (BSI, C-UL-US & CE MARKING) ARE SHOWN HERE IN ACCORDANCE WITH THE SPECIFICATIONS.

B: INPUT AND OUTPUT TERMINAL : 8-φ1.0
C: OPTION

OPTION	ON/OFF LOGIC	OVC/OCP
STANDARD	NEGATIVE(H:OFF/L:ON)	SHUT DOWN
/P	POSITIVE(H:OFF/L:ON)	(ON/OFF CONTROL RESET OR MANUAL RESET)
/V	NEGATIVE(H:OFF/L:ON)	AUTO RESTART
/PV	POSITIVE(H:OFF/L:ON)	

● /C, /CP, /CV, /CPV

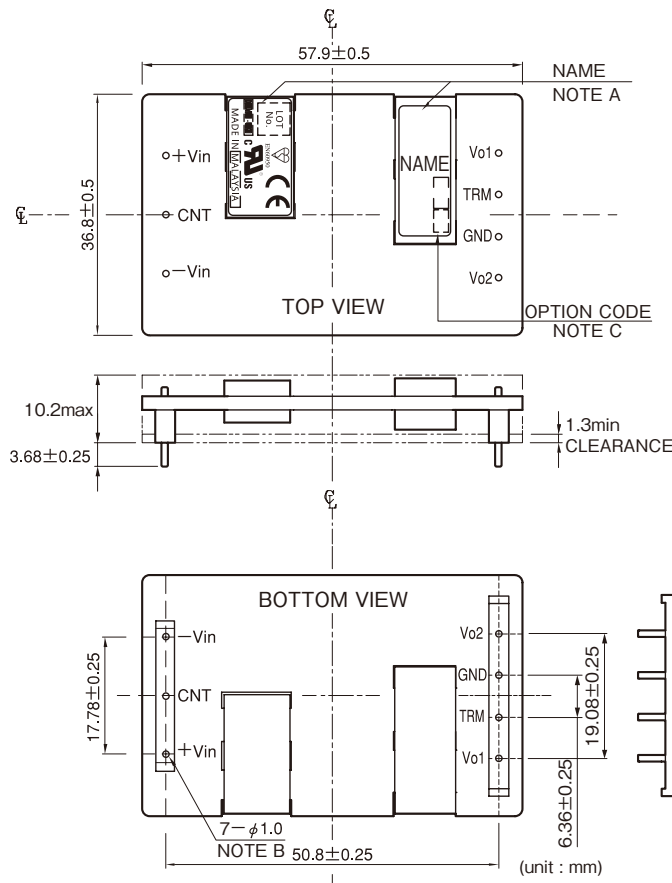

=NOTE=

A: MODEL NAME, COUNTRY OF MANUFACTURE, LOT NO. AND SAFETY MARKING (BSI, C-UL-US & CE MARKING) ARE SHOWN HERE IN ACCORDANCE WITH THE SPECIFICATIONS.

B: INPUT AND OUTPUT TERMINAL : 8-φ1.0
C: OPTION

OPTION	ON/OFF LOGIC	OVC/OCP
/C	NEGATIVE (H:OFF / L:ON)	SHUT DOWN
/CP	POSITIVE (H:OFF / L:ON)	(ON/OFF CONTROL RESET OR MANUAL RESET)
/CV	NEGATIVE (H:OFF / L:ON)	AUTO RESTART
/CPV	POSITIVE (H:OFF / L:ON)	

Output Derating

● **Output derating by ambient temperature**

Please refer to Instruction Manual.

● **Output derating curve with respect to Q15**

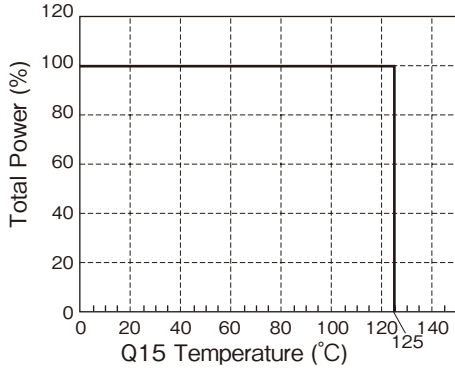

When using with different measuring conditions from those of output derating by ambient temperature, use output derating to keep temperature of MOSFET Q15 below 125°C.

Q15 temperature is decided by temperature of thermal sensor in the center of PCB. When the module operates over the output derating curve of PCB temperature, over thermal protection (OTP) functions and output shutdown.

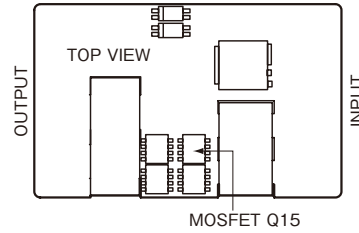

PAQ

Block Diagram

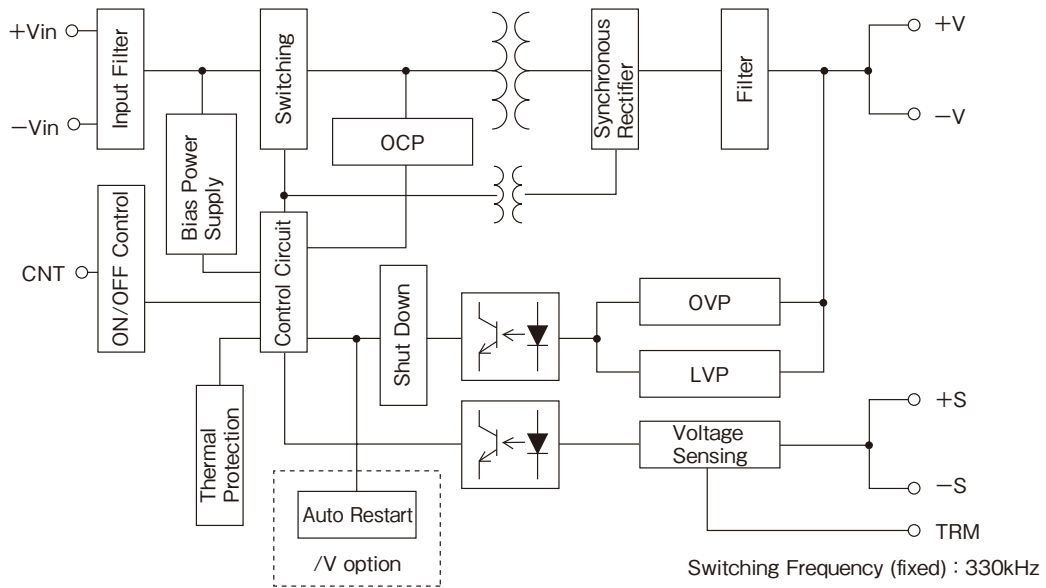

Sequence Time Chart

(For standard model with latch type OVP and OCP, ON/OFF control in negative logic)

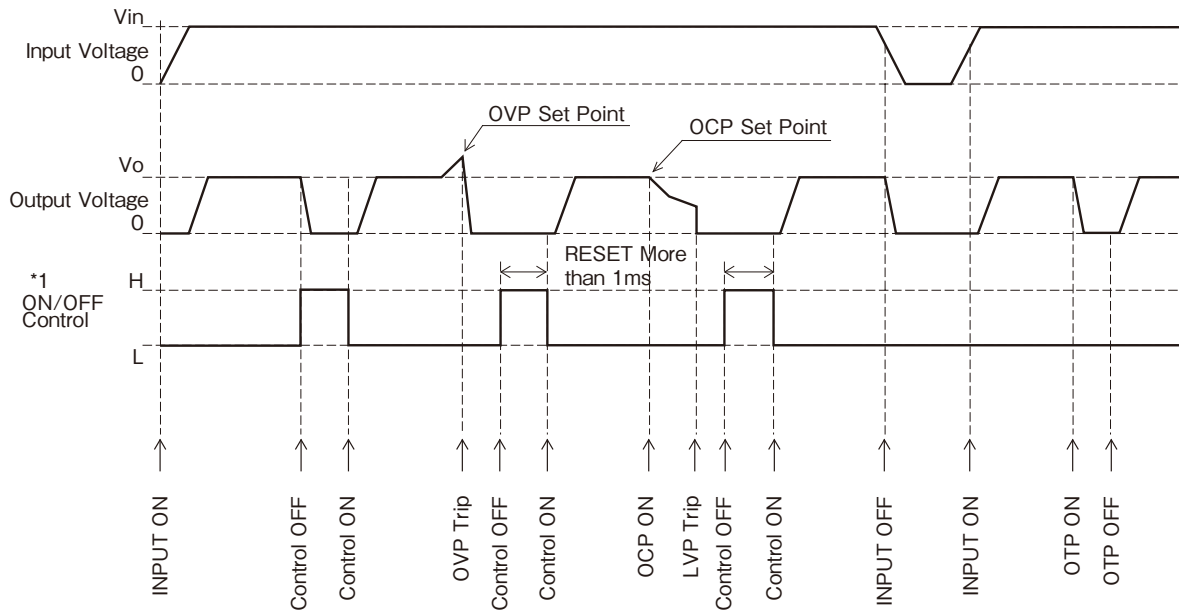

*1 level : $4 \leq H \leq 35(V)$ or Open
 $0 \leq L \leq 0.8(V)$ or Short

Block Diagram

● Standard model, /P, /V, /PV option models

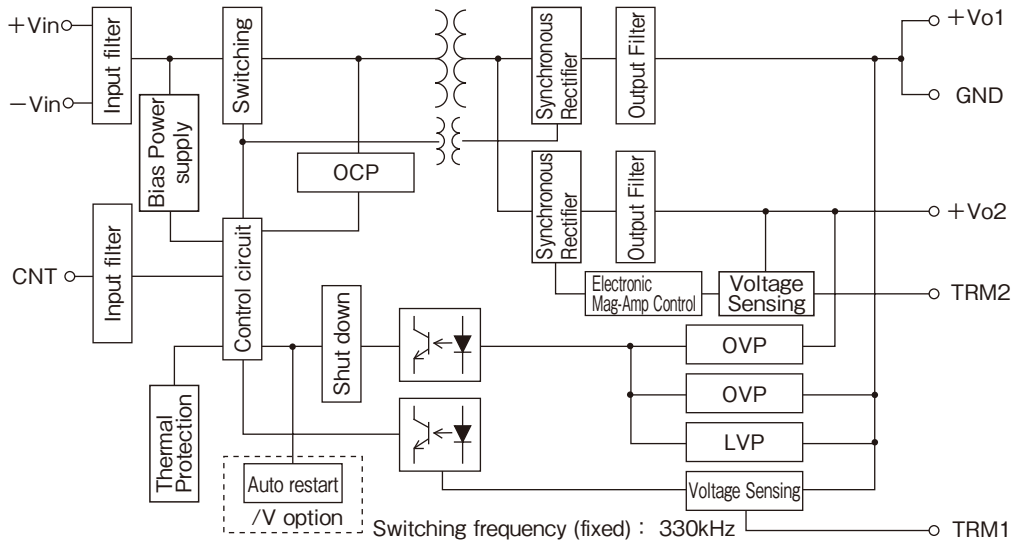

● /C, /CP, /CV, /CPV option models

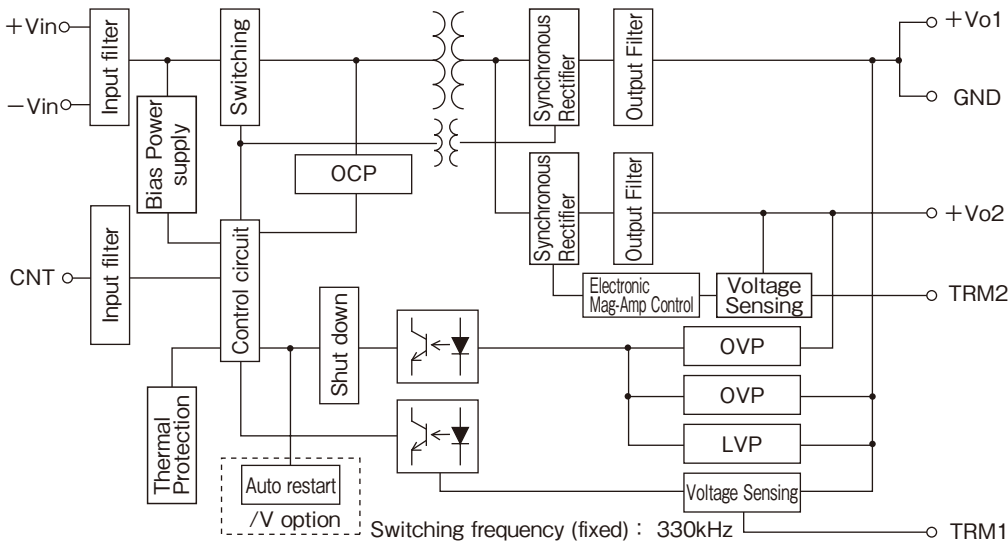

PAQ

Sequence Time Chart

(For standard model with latch type OVP and OCP)

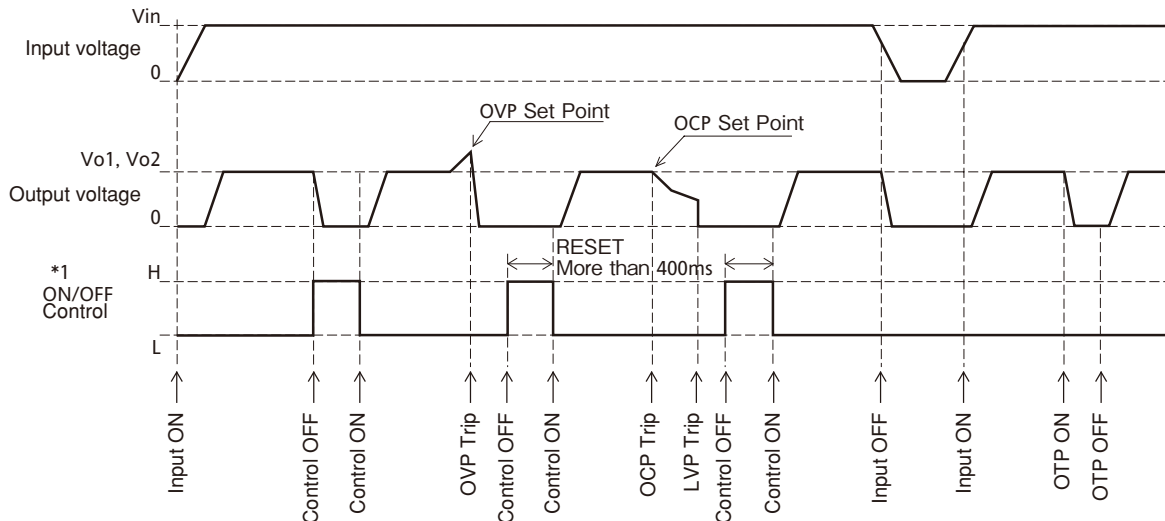

*1 Level : H ≧ 2(V) or Open
 0 ≧ L < 0.8(V) or Short

PAQ-S48 Instruction Manual

- PAQ100S48-*/B Instruction Manual  B-246Page
- PAQ65D Instruction Manual  B-250Page

Before Using This Power Module

Be sure to take note of precautions and warnings indicated in this manual when using this product. Improper usage may lead to electric shock or fire. Be sure to read this instruction manual thoroughly before using this product.

Caution

- There are high voltage and high temperature components within this product. Refrain from disassembling this product or touching its internal components as this may lead to electric shock or burned.
- When the unit is operating, keep your hands and face away from the unit. You may get injured by accident.
- Confirm connections to input/output terminals and signal terminals are correct as indicated in the instruction manual.
- Attach a fast blow type external fuse to each module to ensure safety operation and compliance to each safety standard approval.
- This power module is designed for professional installation within the end user equipment.
- Use isolated voltage by reinforced or double insulation as input power source.

- Do not inject abnormal voltage to output terminal and signal terminal from the outside.
The injection of reverse voltage or over voltage exceeding nominal output voltage to output terminals might cause damage to internal output capacitor (Functional Polymerized Capacitor)
- The application circuits and their parameter are for reference only. Be sure to verify effectiveness of application circuits and their parameters before finalizing circuit design.
- The information in this document is subject to change without prior notice. For actual design-in, please refer to the latest publications of data sheet, etc., for the most up-to date specifications of the unit.
- No part of this document may be copied or reproduced in any form, or by any means without prior written consent of Denset-Lambda.

Note : CE Marking

CE Marking, when applied to a product covered by instruction manual, indicates compliance with the low voltage directive which complies with EN60950

PAQ

1. Terminal Explanation

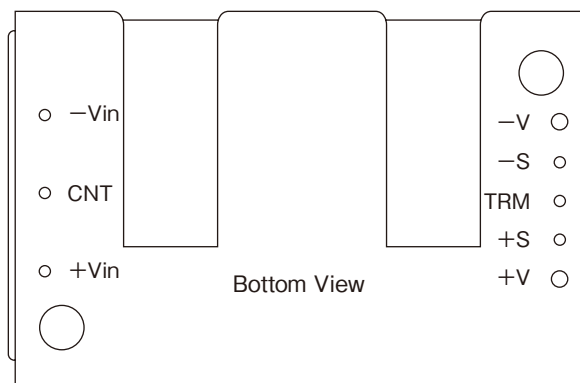

Input and Output Terminal Configurations (Bottom View)

[Input terminal]

-Vin: -Input Terminal
 CNT: ON/OFF Control Terminal
 +Vin: +Input Terminal

[Output terminal]

-V: -Output Terminal
 -S: -Remote Sensing Terminal
 TRM: Output Voltage Trimming Terminal
 +V: +Remote Sensing Terminal
 +S: +Output Terminal

2. Explanation on Specifications

1 Input Voltage Range

Input Voltage Range for PAQ-S48 Series is indicated below.

Input Voltage Range: 36-76VDC

Basically, ripple voltage (V_{rpl}) which results from rectification and filtering of commercial AC line is included within the input voltage as shown in Fig.1-1. Ripple voltage must be limited within the voltage described below.

Allowable input ripple voltage: 4Vp-p

When this value is exceeded, the output ripple voltage becomes large.

Note that sudden input voltage change may cause variation of output voltage transitionally.

Also, input voltage waveform peak value must not exceed above input voltage range.

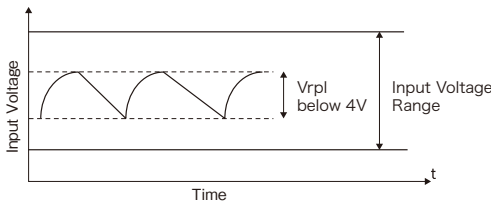

Fig.1-1 Input Ripple Voltage

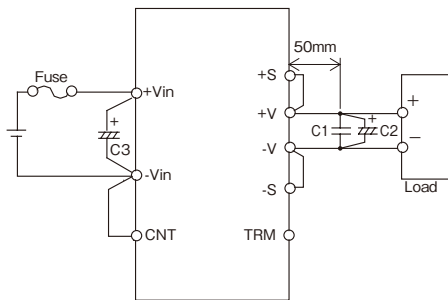

Fig.1-2 Basic Connection

Input Fuse

PAQ-S48 Series module is not internally fused. To ensure safe operation and to receive each Safety Standards approval, please connect an external fuse (fast-blow type) as shown in Fig.1-2.

Fuse must be connected to the +Vin side if -Vin side is used as ground, or fuse must be connected to -Vin side if +Vin side is used as a ground.

Recommended input fuse current rating:

PAQ100S48: 6.3A

PAQ50S48: 5A

C1: 1 μ F, C2: 10 μ F

To reduce spike noise voltage at the output, connect 1 μ F ceramic capacitor and 10 μ F electrolytic capacitor or tantalum capacitor between +V and -V within 50mm distance from the output terminals.

Also, take note that output spike noise voltage could vary according to PCB wiring design.

Maximum capacitance that can be connected between +V and -V, is total 10,000 μ F.

C3:

Input capacitor C3 is recommended to stabilize the module when the module is powered from a high impedance source.

Select the electrolytic capacitor with low ESR and sufficient allowable ripple current.

Verify actual ripple current value by actual measurement.

**Recommended capacitor value: 33 μ F and above
(voltage rating 100V or above)**

Note)

1. Use low impedance electrolytic capacitor with excellent temperature characteristics. (Nippon Chemicon LXV Series or equivalent)
2. When input line inductance becomes excessively high due to insertion of choke coil operation of the power module could become unstable. For this case, increase C3 value more than the value indicated above.
3. When ambient temperature becomes lower than -20°C, connect two capacitors indicate above in parallel.

C4 :

When switches or connectors are used between input source and PAQ-S48 Series input terminals, impulse surge voltage is generated due to input throw-in by switch on/off or due to inserting/removing of power module from the active line. For this case, connect an additional electrolytic capacitor C4 as shown in fig.1-3 and fig.1-4.

**Recommended Capacitor: 33 μ F and above
(Voltage Rating 100V or above)**

Also, in-rush current flows at line throw-in.

Therefore, be sure to verify capability of switch or fuse to withstand I^2t at line throw-in.

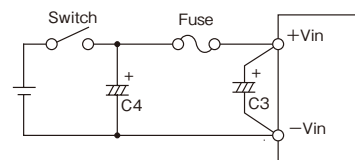

Fig.1-3 Input filter (C4) with Switch

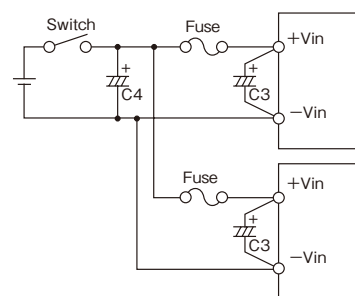

Fig.1-4 Input Filter with Switch when Plural Power

Reverse input connections

Reverse input polarity would cause module damage. For cases where reverse connections are possible, connect a protective diode and fuse. Use protective diode with higher voltage rating than the input voltage, and with higher surge current rating than the fuse.

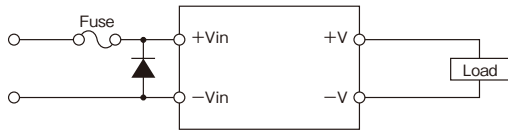

Fig.1-5 Protection for Reversed Input Connection

2 Output Voltage Adjustment Range

Output voltage could be adjusted within the range described below by external resistor or variable resistor. However, take note that OVP might trigger when output voltage adjustment exceeds the ranges indicated below.

Output Voltage Adjustment Range

3.3V, 5V: -15% to +15% of nominal output voltage
 1.2V, 1.8V, 2.5V: -20% to +10% of nominal output voltage

When increasing the output voltage, reduce the output current accordingly so as not to exceed the maximum output power.

For 3.3V and 5V output models, take note that when output voltage is increased, input voltage range is limited as show in fig.2-1.

Also, when output voltage is decreased under output adjustment range, output voltage will shut off.

Remote sensing is possible even when output voltage is varied. For details on remote sensing function, please refer to "9. Remote Sensing."

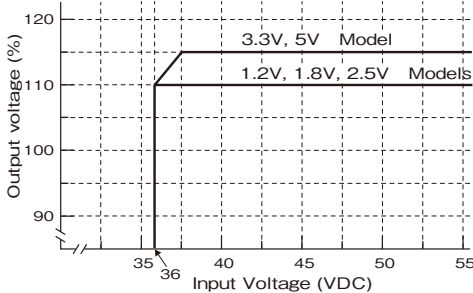

Fig.2-1 Limit of Input Voltage

Output Voltage Adjustment by external resistor or by variable resistor

- (1) In case of adjusting output voltage lower
 - (1-1) Available maximum output current = rated output current
 - (1-2) Connect an external resistor R_{adj} (down) between the TRM terminal and -S terminal.

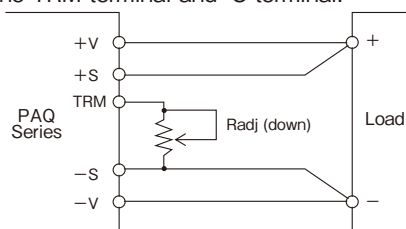

Fig.2-2 Connection for output voltage trim down

- (1-3) Equation of external resistor and output voltage

R_{adj} (down): Value of external resistor
 Δ (%): Output voltage change rate against nominal output voltage

1.2V model

$$R_{adj} \text{ (down)} = \left[\frac{5.777 \times 100 (\%)}{\Delta (\%)} - 10.887 \right] \text{ [k}\Omega\text{]}$$

1.8V, 2.5V, 3.3V, 5V model

$$R_{adj} \text{ (down)} = \left[\frac{5.11 \times 100 (\%)}{\Delta (\%)} - 10.22 \right] \text{ [k}\Omega\text{]}$$

Below graph is relation Δ (%) and value of external resistor.

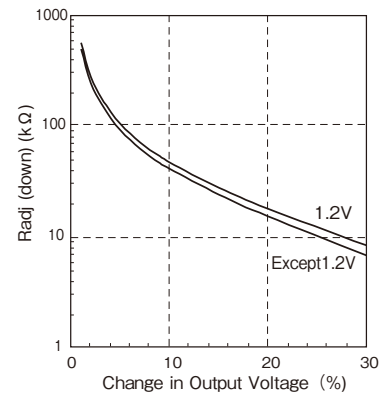

Fig.2-3 Δ (%) vs. R_{adj} (down)

- (2) In case of adjusting output voltage higher
 - (2-1) Allowable maximum output current = value of output power ÷ output voltage (Reduce maximum output current in specification.)
 - (2-2) Connect an external resistor R_{adj} (up) between TRM terminal and +S terminal

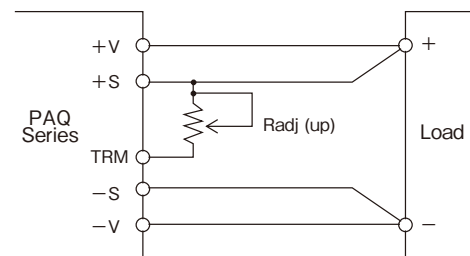

Fig.2-4 Connection for output voltage trim up

- (2-3) Equation of external resistor and output voltage

V_o : nominal output value of module
 R_{adj} (up) : external adjustment resistor
 Δ (%): Output voltage change rate against nominal output voltage

1.2V model

$$R_{adj} \text{ (up)} = \left[\frac{8.665 \times V_o (100\% + \Delta (\%))}{1.225 \times \Delta (\%)} - \frac{5.777 \times 100 (\%)}{\Delta (\%)} - 10.887 \right] \text{ [k}\Omega\text{]}$$

1.8V, 2.5V, 3.3V, 5V model

$$R_{adj} \text{ (up)} = \left[\frac{5.11 \times V_o (100\% + \Delta (\%))}{1.225 \times \Delta (\%)} - \frac{5.11 \times 100 (\%)}{\Delta (\%)} - 10.22 \right] \text{ [k}\Omega\text{]}$$

Below graph is relation Δ (%) and value of external resistor.

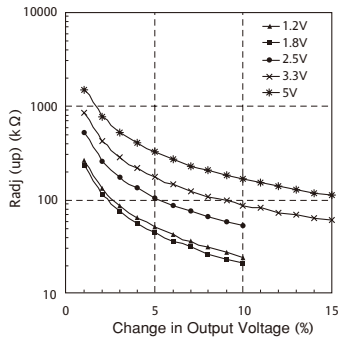

Fig.2-5 Δ (%) vs. Radj (up)

- (3) To adjust output voltage for whole range Resistor values, as well as, connecting methods for external resistor (R1) and external variable resistor (VR) are described below.

Model	1.2V	1.8V	2.5V	3.3V	5V
R1	3.3k	2.2k	4.7k	10k	3.3k
VR	2k	2k	2k	2k	5k

Unit: [k Ω]

Table 2-3
Values of External Resistor and Variable Resistor

$$\left[\begin{array}{l} V_o -20\%, +10\% \quad (1.2V, 1.8V, 2.5V) \\ V_o \pm 15\% \quad (3.3V, 5V) \end{array} \right]$$

Model	1.2V	1.8V	2.5V	3.3V	5V
R1	36k	33k	18k	27k	18k
VR	500	500	1k	1k	2k

Unit: [Ω]

Table 2-4
Values of External Resistor and Variable Resistor ($\pm 10\%$ Variable)

R1: $\pm 5\%$ Tolerance
VR: $\pm 20\%$ Tolerance
with end resistance below 1%

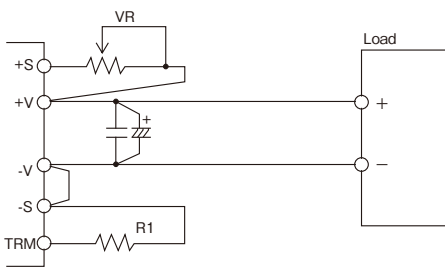

Fig.2-6 Example connection of external resistor

3 Maximum Ripple and Noise

- (1) Measurement based on JEITA RC-9141
Measure according to the specified methods (Fig.3-1) based on JEITA RC-9141 (Clause 7.12 and 7.13) which is described in the following. Connect capacitors (C1: ceramic capacitor 1 μ F, C2: electrolytic capacitor 10 μ F) at 50mm distance from the output terminals. Measure at ceramic capacitor (C2) leads as shown in fig.3-1 using coaxial cable with JEITA attachment. Use oscilloscope with 100MHz frequency bandwidth or equivalent.

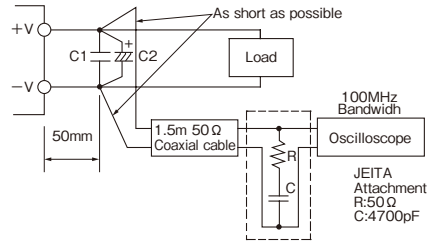

Fig.3-1 Measurement of Maximum Output Ripple & Noise Based on JEITA RC-9141

- (2) Measurement using coaxial cable
Measure according to fig.3-2. Connect capacitors (C1: ceramic capacitor 1 μ F, C2: electrolytic capacitor 10 μ F) at 50mm distance from the output terminals. Measure at ceramic capacitor (C2) leads using coaxial cable. Use oscilloscope with 20MHz frequency bandwidth or equivalent.

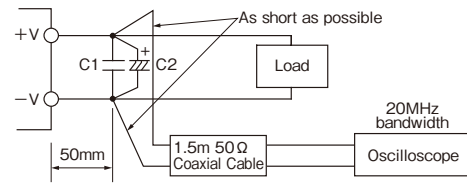

Fig.3-2 Measurement of Maximum Output Ripple & Noise Using coaxial cable

Take note that output ripple voltage and output spike noise may vary depending on PCB wiring design. Generally, output ripple voltage and output spike noise can be reduced by increasing value of external capacitor.

4 Maximum Line Regulation

Maximum line regulation is the maximum value of output voltage change when input voltage is gradually varied within specified input voltage range. The measurement point for the input and output voltage are $\pm V_{in}$ and $\pm S$ (sense point) respectively.

5 Maximum Load Regulation

Maximum value of output voltage change when output current is gradually varied within specified output current range. The measurement point for the input and output voltage are $\pm V_{in}$ and $\pm S$ (sense point) respectively. When using at dynamic load mode, audible noise may be heard from the power module and output voltage fluctuation might increase.

6 Over Current Protection (OCP)

This power module has built-in OCP function. Output will recover when short circuit or overload conditions are released. OCP setting value is fixed and therefore, can not be externally adjusted. Also, take note, when output voltage drops down below lower side of adjustment range for 20ms-50ms by output short circuit or over load conditions, output might be shut down. Output can be recovered by manual reset of the control

ON/OFF terminal or by turning input line off and then turning it on again .

7 Over Voltage Protection (OVP)

This power module has built-in OVP function. OVP set point is relative to the rated output voltage value. When output voltage exceed OVP set point, output voltage shut down. OVP set point is fixed and therefore can not be changed. When OVP is triggered, output can be recovered by turning input line off and then turning it on again after lowering the input voltage below the voltage value indicated below or by manual reset of the control ON/OFF terminal.

Input voltage for OVP reset: 24VDC and below

/V Option (automatic recovery)

The /V optional model will re-start with delay of 200ms-500ms after shutdown by OCP or OVP triggering. When over voltage and over current are removed, output will recover normally.

Verifying OVP function shall be done by increasing output voltage with external resistor. For verifying OVP function, avoid applying external voltage to output terminal because this will cause power module damage.

8 Over Thermal Protection (OTP)

This power module has built-in OTP function. This function operates and shuts down the output when temperature of the power module rises abnormally. Take note that OTP will operate again unless the cause of abnormal heat of the power module is eliminated.

For the details of OTP, refer to the clause of "Mounting Method and Thermal Condition".

9 Remote Sensing (+S, -S Terminal)

Remote sensing terminal is provided to compensate for voltage drop across the wirings from the power module output terminal to the load input terminal. When remote sensing function is not used (local sensing), short +S terminal to +V terminal and, -S terminal to -V terminal.

Take note that voltage compensation range for line drop (voltage drop due to wiring) should be kept such that output voltage at the output terminals is within output voltage range and the maximum power is not exceeded. Use shielded wire, twist pair, or parallel pattern to reduce noise effect.

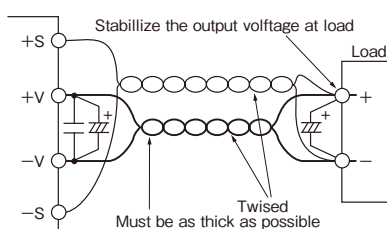

Fig.9-1 Remote Sensing in Use

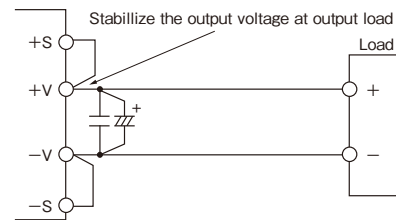

Fig.9-2 Remote Sensing Not in Use (Local Sensing)

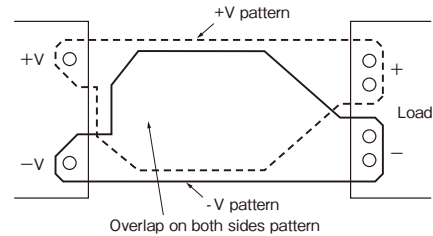

Fig.9-3 Load pattern layout example (by) using double side PCB

10 ON/OFF Control (CNT Terminal)

Without turning the input supply on and off, the output can be enabled and disabled using this function. This function also can be used for output sequence of plural modules ON/OFF control circuit is on the primary side (the input side), CNT Terminal pin. For secondary control, isolation can be achieved through the use of a opto coupler or relay.

CNT Terminal Level to -Vin Terminal	Output Status
H Level ($4V \leq H \leq 35V$) or Open	OFF
L Level ($0V \leq L \leq 0.8V$) or Short	ON

* When control function is not used, CNT terminal is shorted to -Vin terminal.

* When using long wiring, for prevention of noise, attach a 0.1μF capacitor between CNT Terminal and -Vin terminal.

* At L level, maximum source current from CNT Terminal to -Vin terminal is 0.5mA.

* The maximum CNT Terminal voltage when it is opened is 35V.

(1) Output ON/OFF control

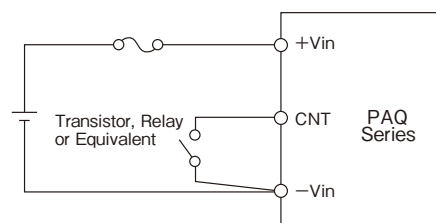

(2) Secondary (output side) control

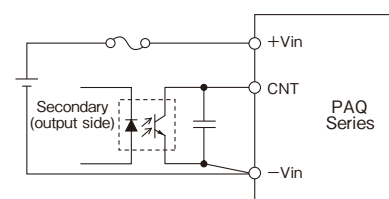

Fig.10-1 CNT connection

11 Parallel Operation

Parallel Operation can not be used.

12 Series Operation

Series operation is possible for PAQ-48 series. Connections shown in fig.12-1 and fig.12-2 is possible.

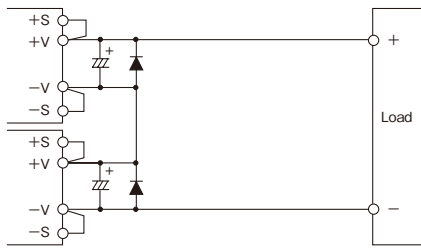

Fig.12-1 Series Operation for High Output Voltage Application

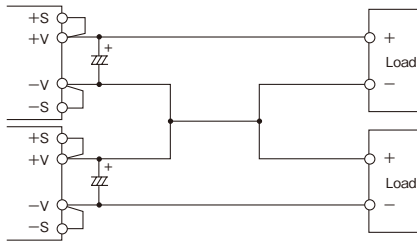

Fig.12-2 ±Output Series Operation

13 Operating Ambient Temperature

According to ambient temperature, output load should derated accordingly (refer to Mounting Method & Terminal Condition). There is no restriction on mounting direction but there should be enough consideration for airflow so that heat does not accumulate around the power module vicinity. Determine external components configuration and mounting direction on PCB such that air could flow through power module at forced air cooling or convection cooling. For better reliability, derating of ambient temperature is recommended. For details on derating, refer to "Mounting Method & Thermal Condition"

14 Operating Ambient Humidity

Take note that moisture could lead to power module abnormal operation or damage.

15 Storage Ambient Temperature

Abrupt temperature change would cause condensation built-up that leads to poor solderability of terminals of the power module.

16 Storage Ambient Humidity

High temperature and humidity can cause the terminals on the module to oxidize. The quality of the solder will become worse.

17 Cooling Method

Forced air cooling is recommended. Convection cooling is also possible. For the details of derating, refer to "Mounting Method and Thermal Condition"

18 Ambient Temperature vs. Output Voltage Drift

Temperature coefficient is defined as the rate of voltage change when ambient temperature is changed during operation.

19 Withstand Voltage

This power module is designed to have a withstand voltage of 1.5kVDC between input and output. When conducting withstand voltage test during incoming inspection, be sure to apply DC voltage. Also, set the current limit value of the withstand voltage testing equipment to 10mA. Be sure to avoid conducting test with AC voltage because this would cause power module damage. Furthermore, avoid throw in or shut off of the testing equipment when applying or when shutting down the test voltage. Instead, gradually increase or decrease the applied voltage. Take note especially not to use the timer of the test equipment because when the timer switches the applied voltage off, impulse voltage which has several times the magnitude of the applied voltage is generated causing damage to the power module. Short the output side as shown in the diagram below.

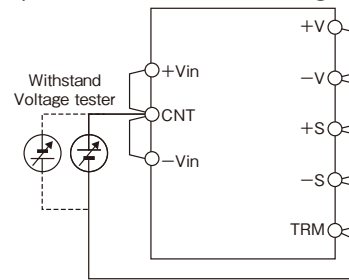

1.5kVDC 1minute (10mA)
Fig.19-1 Withstand Voltage Test for Input-Output

20 Insulation Resistance

Use DC insulation tester (MAX 500V) between output and input. Insulation resistance value is 100MΩ and above at 500VDC applied voltage. Make sure that during testing, the isolation testers does not produce a high pulse when the applied voltage is varied. Ensure that the tester is fully discharged after the test.

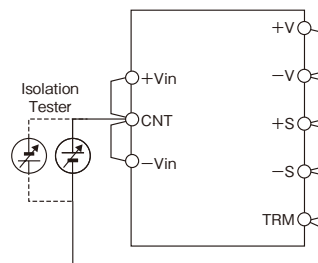

Fig.20-1 Isolation test

21 Vibration

Vibration of power module is defined in case of mounting on PCB.

22 Shock

Value for the conditions of out shipping and packaging.

PAQ

3. Mounting Method and Thermal Condition

1 Output derating

There is no restriction on mounting direction but there should be enough consideration for airflow so that heat does not accumulate around the power module vicinity. Determine external components configuration and mounting direction on PCB such that air could flow through power module at forced air cooling or convection cooling. Take note, output power derating is needed as shown in followings. (Refer to output derating by ambient temperature).

The derating curves provided is based on the below set-up condition. For actual application with difficulty of air flow measurement, find of PCB temperature is recommended to ensure the power module operates within derating curve. (Refer to Output derating by PCB temperature)

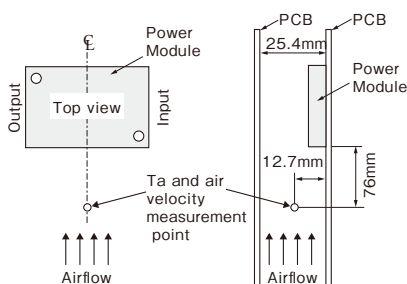

Fig.1-1

(1) Output Derating by ambient temperature

PAQ100S48 Vin=48VDC

PAQ100S48-1R2 (including /V option)

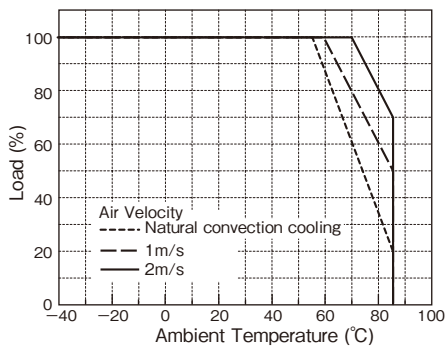

Fig.1-2

PAQ100S48-1R8 (including /V option)

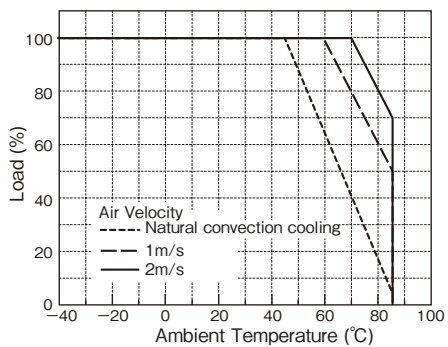

Fig.1-3

PAQ100S48-2R5 (including /V option)

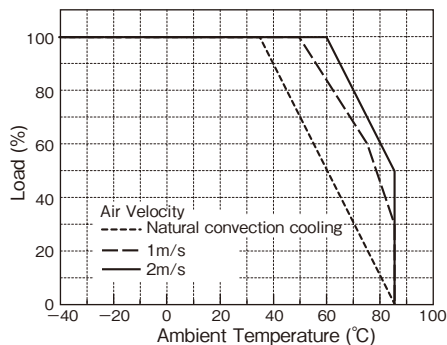

Fig.1-4

PAQ100S48-3R3 (including /V option)

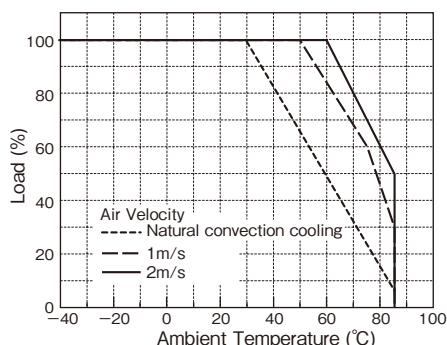

Fig.1-5

PAQ100S48-5 (including /V option)

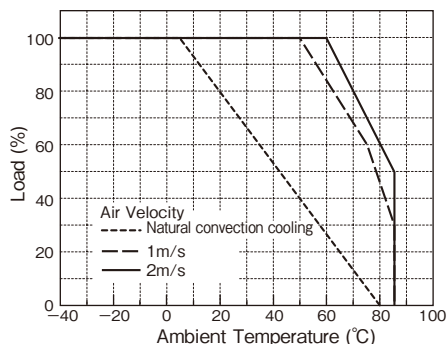

Fig.1-6

PAQ50S48 Vin=48VDC

PAQ50S48-1R2 (including /V option)

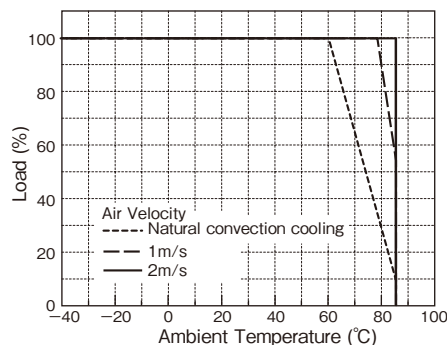

Fig.1-7

PAQ

PAQ50S48-1R8 (including /V option)

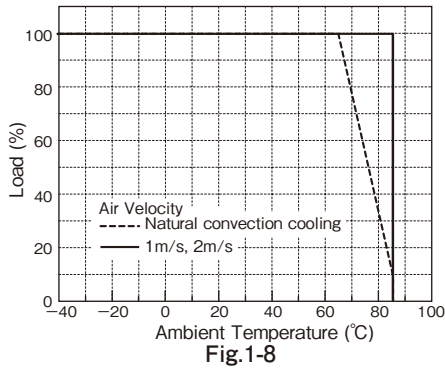

Fig.1-8

PAQ50S48-2R5 (including /V option)

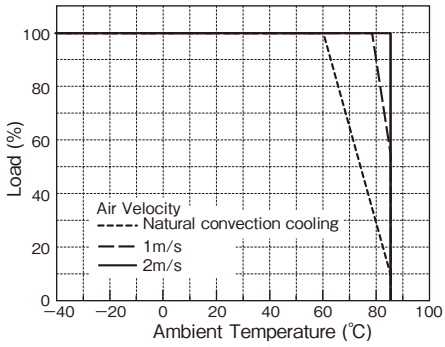

Fig.1-9

PAQ

PAQ50S48-3R3 (including /V option)

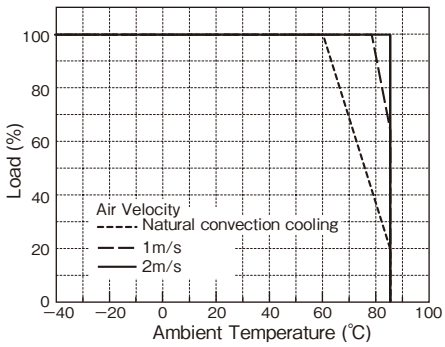

Fig.1-10

PAQ50S48-5 (including /V option)

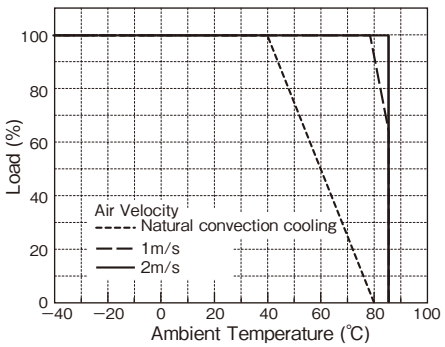

Fig.1-11

(2) Output derating by PCB

When use with different measurement conditions from output derating by ambient temperature, use output derating by PCB temperature as in Fig.1-13 and 1-14. PCB temperature is decided by temperature of thermal sensor in below Fig.1-12. As the thermal sensor terminals are exposed, when connecting

thermocouple, please take sufficient insulation from terminals. Over Thermal Protection of power module is achieved by detecting the PCB temperature through thermal sensor. When the module operates over the output derating curve of PCB temperature, Over Thermal Protection (OTP) functions and output shutdown. Therefore, measurement of PCB temperature is recommended to ensure the module to operate within the derating curve.

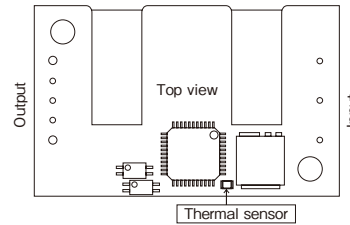

Fig.1-12 Thermal Sensor Position

Output Derating by PCB Temperature

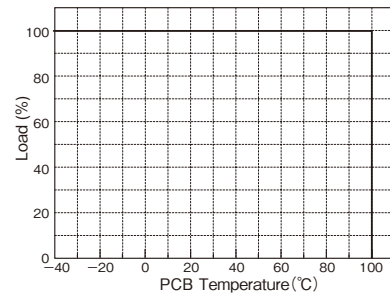

Fig.1-13 Output Derating by PAQ100S48 PCB Temperature

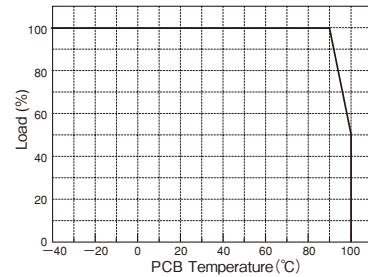

Fig.1-14 Output Derating by PAQ50S48 PCB Temperature

2 Mounting Method

(1) Prohibition area of pattern wiring

Avoid wiring pattern on PCB in shaded area as shown in Figure 2-1 as it may cause insulation problem.

Since the power module may influence by noise, care must be taken when wire the signal line on the unshaded area.

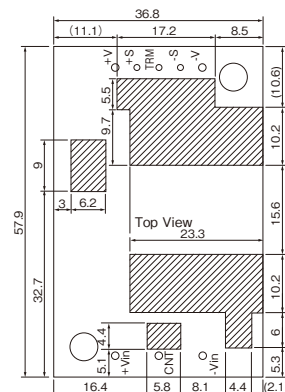

Fig.2-1 Prohibition area of wiring pattern

- (2) Mounting hole on PCB
Diameter of hole and land of PCB with referring below.

Type	PAQ-S48
Input Terminal Pin	φ 1.0mm
Hole Diameter	φ 1.5mm
Land Diameter	φ 3.0mm
Output Terminal Pin	φ 1.5mm
Hole Diameter	φ 2.0mm
Land Diameter	φ 4.0mm
Signal Terminal Pin	φ 1.0mm
Hole Diameter	φ 1.5mm
Land Diameter	φ 3.0mm

For position of the holes, see outline drawing of the power module.

- (3) Recommended Material of PCB
Recommended materials of the printed circuit board is double sided glass epoxy with through holes. (thickness: t=1.6mm)
- (4) Output Pattern Width
When several to tens amperes of current flows to output pattern, voltage would drop and heat generation would be higher for narrow pattern. Relationship between current and pattern width changes depending on material of printed circuit board, thickness of conductor, temperature raise allowance. 35mm copper glass epoxy printed circuit board is shown in Figure2-2 as an example.
For example, when 5A of current flows and temperature rise below 10°C are expected, pattern width shall be more than 4.2mm with 35μm copper plate (generally 1mm/A is standard). Confirmation is definitely necessary for designing because characteristics shown in figure 2-2 depends on manufactures of printed circuit board.

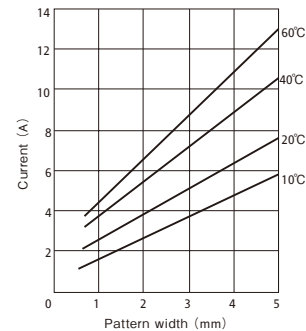

Fig.2-2 Characteristic of current allowance

3 Recommended Soldering Method

Recommended soldering temperature is as follows.

- (1) Soldering dip 260°C within 6seconds
Pre-heat condition 110°C 30-40seconds
- (2) Soldering iron 350°C within 3seconds

4 Recommended Cleaning Condition

Recommended cleaning condition after soldering is as follows.

- Cleaning solvent
IPA (isopropyl alcohol)
- Cleaning Procedure
Use brush and dry the solvent completely.

Note) For other cleaning methods, contact us.

PAQ

Before concluding power module damage



Verify following items before concluding power module damage.

- 1) No output voltage
 - Is specified input voltage applied?
 - Are the ON/OFF control terminal (CNT terminal), remote sensing terminal (+S, -S), output voltage trimming terminal (TRIM) correctly connected ?
 - For cases where output voltage adjustment is used, is the resistor or variable resistor setting, connections correctly done?
 - Are there no abnormalities in the output load used?
 - Is the baseplate temperature within the specified temperature range?
- 2) Output voltage is high.
 - Are the remote sensing terminals (+S, -S) correctly connected?
 - Is the measurement done at the sensing points?
 - For cases where output voltage adjustment is used, is the resistor or volume setting, connections correctly done?
- 3) Output voltage is low
 - Is specified input voltage applied?
 - Are the remote sensing terminals (+S, -S) correctly connected?
 - Is the measurement done at the sensing points?
 - For cases where output voltage adjustment is used, is the resistor or variable resistor setting, connections correctly done?
 - Are there no abnormalities in the output load used?
- 4) Load regulation and line regulation is large
 - Is specified input voltage applied?
 - Are the input terminals and the output terminals firmly connected?
 - Is the measurement done at the sensing points?
 - Is the input or output wire too thin?
- 5) Output ripple voltage is large
 - Is the measuring method used the same or equivalent with the specified method in the Application Notes?
 - Is the input ripple voltage value within the specified value?

PAQ100S48-*/B**Instruction Manual

Note

● This instruction manual describes only changed items from the standard model's instruction manual.

- PAQ-S Instruction Manual  B-237Page
- PAQ65D Instruction Manual  B-250Page
- Please refer to "PAQ-S48 Series instruction manual" more details.

1. Output Derating

There is no restriction on mounting direction but there should be enough consideration for airflow so that heat does not accumulate around the power module vicinity. Determine external components configuration and mounting direction on PCB such that air could flow through power module at forced air cooling or convection cooling. By maintaining baseplate temperature below 100°C, operation is possible. But according to the models, output derating is needed as shown in figure 1-1. Measure baseplate temperature at center of baseplate as indicated in fig.1-2. For better improvement of power module reliability, more derating of baseplate temperature when using is recommended.

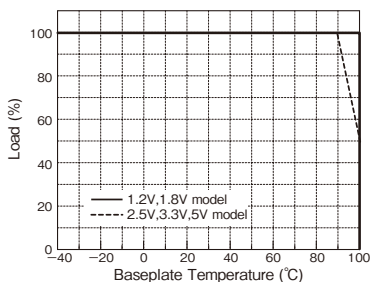

Fig.1-1 PAQ100S48/B Output Derating

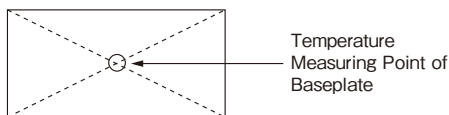

Fig.1-2 Temperature Measuring Point of Baseplate

Forced cooling to power module improve radiation capability more than convection cooling. Figure 1-3 indicates thermal resistance value between baseplate and air at standard vertical mounting. For details on standard vertical mounting, refer to "PAQ-S48 Series Instruction Manual" Figure 1-4 to 1-8 indicates power dissipation (Pd) of each models at following condition.

Output Voltage: Nominal value
Ambient Temperature: 60°C

An example of thermal design using these condition is shown as follows.

1 Example of Thermal design

Calculate minimum necessary air velocity at following condition.

Use Model: PAQ100S48-5/B
Input Voltage: 48V
Maximum Output Current: 15A
Maximum Ambient Temperature: 65°C
Mounting Method: Standard Vertical Mounting
Power dissipation is as shown in Fig.1-8

$$Pd=9.0 \text{ (W)}$$

Maximum baseplate temperature (Tbp) at output current 15A is as shown in Fig. 1-1

$$Tbp=95 \text{ (}^\circ\text{C)}$$

Therefore

$$Tbp = Ta + \theta_{bp-a} \times Pd$$

Ta: Ambient temperature (°C)
 θ_{bp-a} : Thermal Resistance (°C /W)
(Baseplate - Air)

Equation is as follows.

$$\theta_{bp-a} = \frac{Tbp - Ta}{Pd} = 3.33 \text{ (}^\circ\text{C /W)}$$

Air Velocity is as shown in Fig.1-3.

$$\text{Air Velocity} = 0.8 \text{ (m/s)}$$

This is minimum necessary air velocity at above condition. Measure actual baseplate temperature and verify it is same as the design. If there are discrepancy, re-check each condition and re-design.

Note

- 1) Data shown in Fig.1-3 to 1-8 is the typical value and it changes depending on measurement condition. Recommend to design with sufficient margin against calculation value.
- 2) When the condition of input voltage and output voltage are different and it is impossible to determine power dissipation (Pd) from Fig.1-4 to 1-8, calculate power dissipation as follows.

$$Pd = Pin - Pout = \frac{100 - \eta}{\eta} \times Pout$$

Pin: Input Power (W)
Pout: Output Power (W)
 η : Efficiency (%)

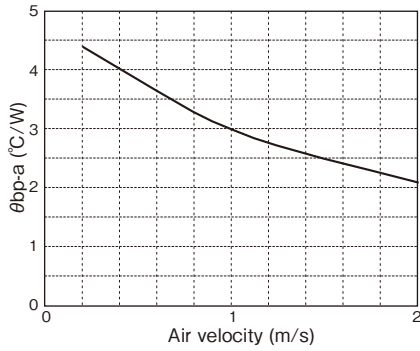

Fig.1-3 Thermal resistance at Baseplate-Air vs Air velocity (typical value)

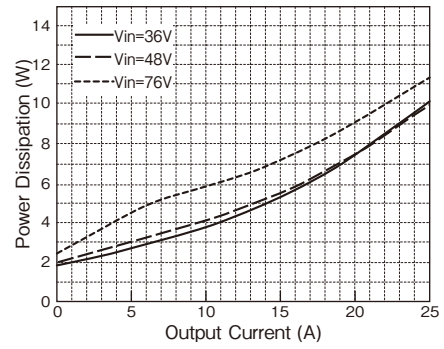

Fig.1-6 PAQ100S48-2R5/B Power dissipation vs Output Current (Output voltage: Nominal, Ta=60°C; typical value)

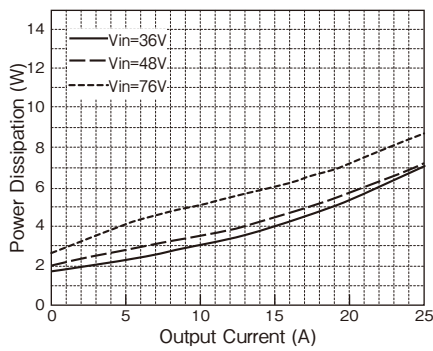

Fig.1-4 PAQ100S48-1R2/B Power dissipation vs Output Current (Output voltage: Nominal, Ta=60°C; typical value)

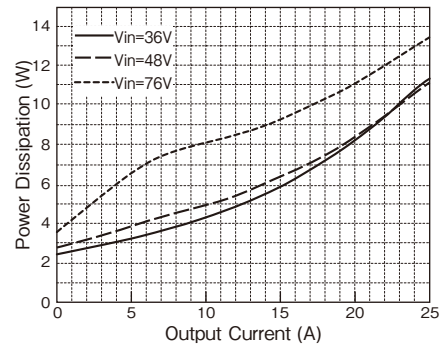

Fig.1-7 PAQ100S48-3R3/B Power dissipation vs Output Current (Output voltage: Nominal, Ta=60°C; typical value)

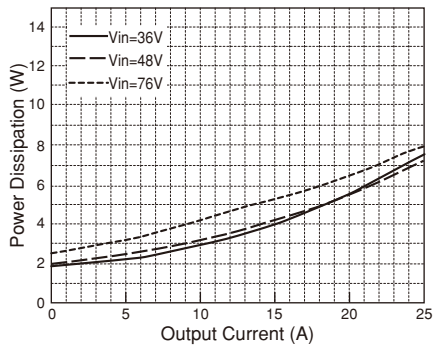

Fig.1-5 PAQ100S48-1R8/B Power dissipation vs Output Current (Output voltage: Nominal, Ta=60°C; typical value)

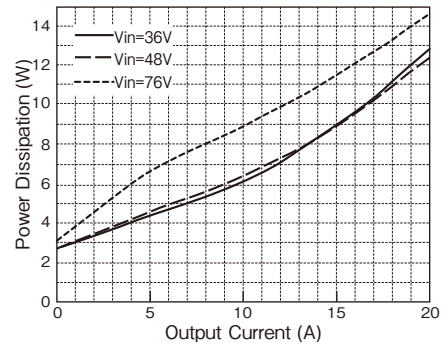

Fig.1-8 PAQ100S48-5/B Power dissipation vs Output Current (Output voltage: Nominal, Ta=60°C; typical value)

PAQ

2 Output derating against ambient temperature (reference value)

Following the previous design example, output derating against ambient temperature can be determined by the following conditions as shown in Fig.1-9 to 1-13. These value are for reference only. Be sure to verify baseplate temperature is within output derating as shown in Fig.1-1.for actual design-in

- Input Voltage: 48V
- Output Voltage: Nominal value
- Cooling Method: Convection cooling or forced air cooling (1m/s, 2m/s)
- Mounting Method: Standard vertical mounting

At this case, convection cooling means 0.2m/s air flows by power module heating itself.

At vertical mounting Vin =48VDC

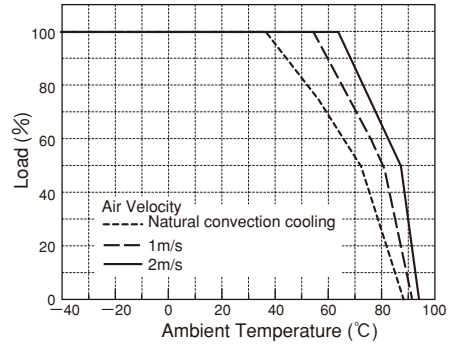

Fig.1-13 PAQ100S48-5/B
Output Derating at Ambient Temperature
(Vin=48V: reference value)

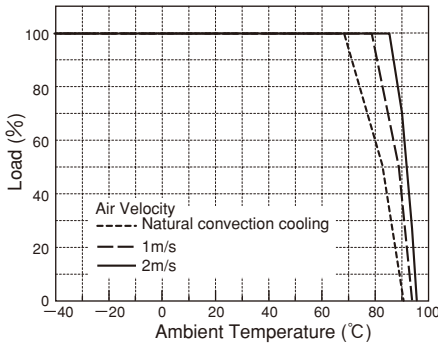

Fig.1-9 PAQ100S48-1R2/B
Output Derating at Ambient Temperature
(Vin=48V: reference value)

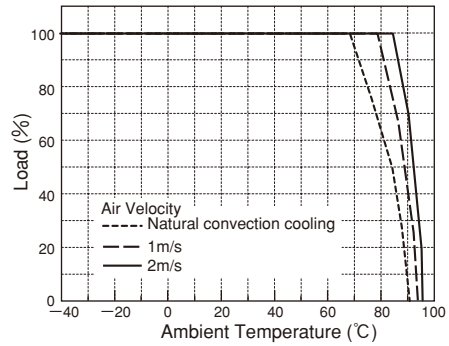

Fig.1-10 PAQ100S48-1R8/B
Output Derating at Ambient Temperature
(Vin=48V: reference value)

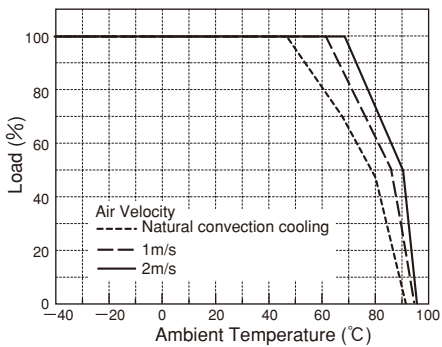

Fig.1-11 PAQ100S48-2R5/B
Output Derating at Ambient Temperature
(Vin=48V: reference value)

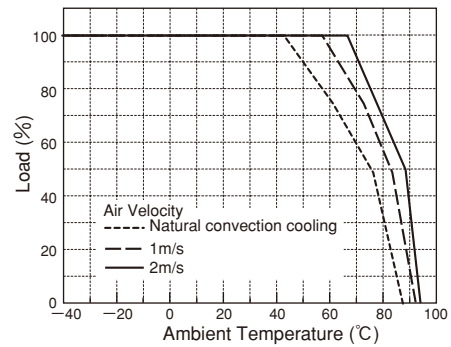

Fig.1-12 PAQ100S48-3R3/B
Output Derating at Ambient Temperature
(Vin=48V: reference value)

PAQ

2. PCB Mounting Method

By the following instruction shown in Fig2-1, mount power module onto printed circuit board.

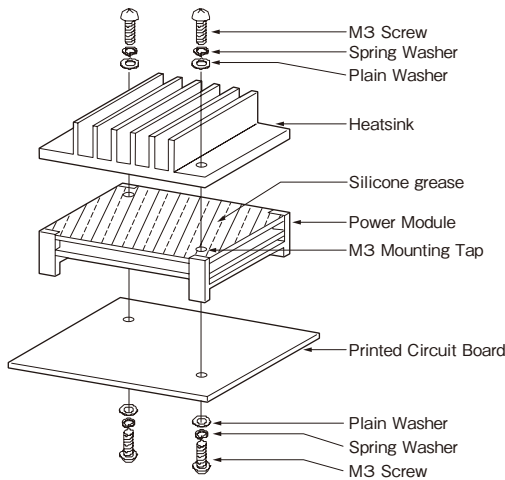

Fig2-1. Installation of Printed Circuit Board and Heatsink

1 Method to Fix

To fix a power module onto printed circuit board, use M3 screws and mount it to the tapped holes (2 places) of the module. Recommended torque is 0.54N·m.

2 M3 Mounting Tapped Holes

M3 mounting tapped holes of power module are connected to baseplate. Connect baseplate terminal to FG (Frame Ground) by using this M3 mounting tapped holes.

3 Mounting Holes on Printed Circuit Board

Refer to the following sizes when determining diameter of hole and land diameter of printed circuit board.

PAQ100S48/B

Input/Signal terminal pin ($\phi 1.0\text{mm}$)

Hole diameter: $\phi 1.5\text{mm}$

Land diameter: $\phi 2.5\text{mm}$

Output terminal pin ($\phi 1.5\text{mm}$)

Hole diameter: $\phi 2.0\text{mm}$

Land diameter: $\phi 3.5\text{mm}$

M3 Mounting Tap (FG)

Hole diameter: $\phi 3.5\text{mm}$

Land diameter: $\phi 5.5\text{mm}$

4 Clearance from Customer Board

Minimum clearance between PAQ100S48/B and a customer board is 1.5mm

The power module may influence by noise, care must be taken when wire the signal line.

PAQ

3. Heatsink Installation Method

1 Method to Fix

To fix the power module onto heatsink, use M3 screws and mount it to the tapped holes (2 places) at the baseplate side. Recommended torque is 0.54N·m.

Use with thermal grease or thermal sheet in between heatsink and baseplate to minimize the contact thermal resistance and to enhance the heat conductivity. Also use the no-warped heatsink and make sure good contact between baseplate and heatsink.

2 Mounting Hole of Heatsink

The recommended mounting hole diameter of the heatsink is $\phi 3.5\text{mm}$.

4. Vibration

The vibration specification of the module is determined assuming that only the power module is mounted on printed circuit board. To prevent excessive force to the module

and the printed circuit board, fix the heatsink to the chassis as well as to the module when a large size of heatsink is used.

PAQ65D SERIES Instruction Manual

● PAQ-S Instruction Manual  B-237Page

● PAQ100S48-*/B Instruction Manual  B-246Page

Before Using This Power Module

Be sure to take note of precautions and warnings indicated in this manual when using this product. Improper usage may lead to electric shock or fire. Be sure to read this instruction manual thoroughly before using this product.

Caution

- There are high voltage and high temperature components within this product. Refrain from disassembling this product or touching its internal components as this may lead to electric shock or burned.
- When the unit is operating, keep your hands and face away from the unit. You may get injured by accident.
- Confirm connections to input/output terminals and signal terminals are correct as indicated in the instruction manual.
- Attach a fast blow type external fuse to each module to ensure safety operation and compliance to each safety standard approval.
- This power module is designed for professional installation within the end user equipment.
- Use isolated voltage by reinforced or double insulation as input power source.

- Do not inject abnormal voltage to output terminal and signal terminal from the outside.
- The injection of reverse voltage or over voltage exceeding nominal output voltage to output terminals might cause damage to internal output capacitor (Functional Polymerized Capacitor).
- The application circuits and their parameter are for reference only. Be sure to verify effectiveness of application circuits and their parameters before finalizing circuit design.
- The information in this document is subject to change without prior notice. For actual design-in, please refer to the latest publications of data sheet, etc., for the most up-to date specifications of the unit.
- No part of this document may be copied or reproduced in any form, or by any mean without prior written consent of Densai-Lambda.

Note : CE Marking

CE Marking, when applied to a product covered by instruction manual, indicates compliance with the low voltage directive which complies with EN60950

PAQ

1. Terminal Descriptions

● Standard Model Input and Output Terminal Descriptions

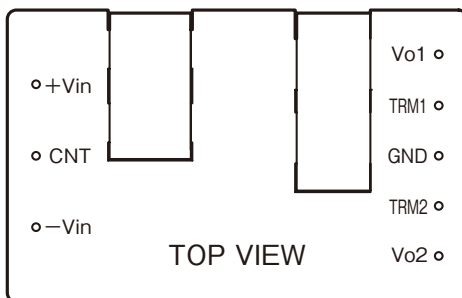

[Input Terminal]
 +Vin: Positive Input
 CNT: ON/OFF Control
 -Vin: Negative Input

[Output Terminal]
 Vo1: Channel 1 (CH1) Positive Output
 TRM1: CH1 Output Voltage Trimming
 GND: Output Ground (for CH1 & CH2)
 TRM2: CH2 Output Voltage Trimming
 Vo2: Channel 2 (CH2) Positive Output

● /C Option Model Input and Output Terminal Descriptions

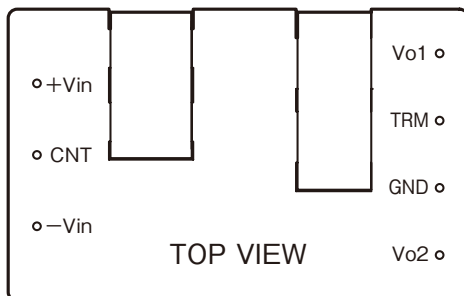

[Input Terminal]
 +Vin: Positive Input
 CNT: ON/OFF Control
 -Vin: Negative Input

[Output Terminal]
 Vo1: Channel 1 (CH1) Positive Output
 TRM: CH1 & CH2 Output Voltage Trimming
 GND: Output Ground (for CH1 & CH2)
 Vo2: Channel 2 (CH2) Positive Output

2. Explanation on Specifications

1 Basic Connection

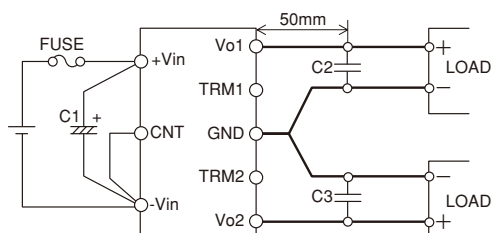

Fig.1-1: Basic Connection

Input Fuse

PAQ65D48 Series module is not internally fused. To ensure safe operation and to receive each Safety Standards approval, please connect an external fuse (fast-blow type) as shown in Fig.1-1. Recommended input fuse current rating is 5A.

Fuse must be connected to the +Vin side if -Vin side is used as ground, or fuse must be connected to -Vin side if +Vin side is used as a ground.

C1: 33 μ F

Input capacitor C1 is recommended to stabilize the module when the module is powered from a high impedance source. Select the electrolytic capacitor with low ESR and sufficient allowable ripple current. Verify actual ripple current value by actual measurement. The recommended capacitor value is 33 μ F and above (voltage rating 100V or above).

Note:

1. Use low impedance electrolytic capacitor with excellent temperature characteristics. (Nippon Chemicon LXV Series or equivalent)
2. When the input line inductance becomes excessively high due to insertion of choke coil operation of the power module could become unstable. For this case, increase C1 value more than the value indicated above.
3. When the ambient temperature becomes lower than -20°C, it is recommended to use 33 μ F ceramic capacitor.

C2 and C3: 22 μ F

To reduce spike noise voltage at the output, connect a 22 μ F ceramic capacitor across the +Vo and GND of each output. The position of the capacitor should be within 50mm distance from the output terminals. Also, take note that output spike noise voltage could vary according to PCB wiring design.

Note:

1. Total maximum capacitance that can be connected between +Vo and GND is 4,700 μ F for each output.
2. If using electrolytic capacitor, use a low impedance type (such as Nippon Chemicon LXV series or equivalent) with excellent temperature characteristics or parallel a few electrolytic capacitors; especially at negative temperature operation.

C4:

When switches or connectors are used between input source and PAQ65D48 Series input terminals, impulse surge voltage is generated due to input throw-in by switch on/off or due to inserting/removing of power module from the active line. For this case, connect an additional electrolytic capacitor C4 of 33 μ F as shown in Fig.1-2 and Fig.1-3.

Also, there will be in-rush current flows at input throw-in condition. Therefore, be sure to verify the capability of switch or fuse to withstand I^2t at line throw-in.

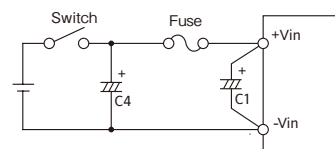

Fig.1-2: Input filter (C4) with Switch

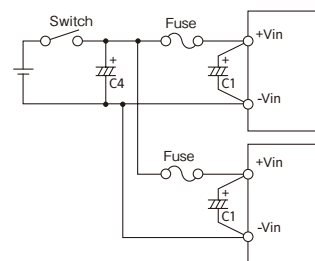

Fig.1-3: Input Filter with Switch when Multiple Power Modules are used.

Reverse input connections

A reverse input voltage polarity applied will cause the module to damage. For cases where reverse connections are possible, connect a protective diode and fuse as shown in Fig.1-4. Use protective diode with higher voltage rating than the input voltage, and with higher surge current rating than the fuse.



Fig.1-4: Protection for Reversed Input Connection

2 Input Voltage Range

The operating Input Voltage Range for PAQ65D48 Series is 36 - 76VDC.

Ripple voltage (V_{rpl}) which results from rectification and filtering of commercial AC line is included within the input voltage as shown in Fig.2-1. For example, input voltage waveform peak value must not exceed above input voltage range.

In addition, the allowable input ripple voltage must be limited within 4 Volt peak-peak. When this value is exceeded, the output ripple voltage will become large.

Note that sudden input voltage change may cause variation of output voltage transitionally.

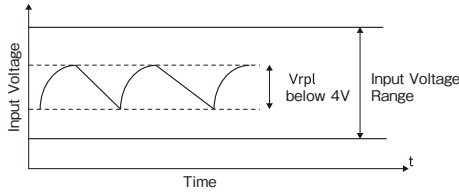

Fig.2-1: Input Ripple Voltage

3 Output Voltage Adjustment Range

Output voltage can be adjusted by using the trim function. There are 2 options available for the trim function, which are

- a) **Standard Model Trim:** 2 independent trim to adjust each output voltage individually. Note that the height of power module is 8.9mm. When both output voltage trim function are being use, make sure that $V_{o1}-V_{o2}$ is always equal or larger than 0.5V; ($V_{o1}-V_{o2} \geq 0.5V$). The allowable trim range for both output are as shown in the next page; Page 7, Figure3-1.
- b) **/C Option Model Trim:** A single trim to adjust both the output voltage simultaneously. Note that the height for this option model is 10.2mm. This model is compatible to other manufacturers power module.

Note:

- a) OVP might trigger when output voltage adjustment exceeds the maximum allowable range specified in the following section.
- b) Output under voltage protection for V_{o1} might trigger if V_{o1} is decreased below the minimum allowable range.
- c) When increasing the output voltage, reduce the output current accordingly so as not to exceed the maximum output power.
- d) When decreasing the output voltage, the allowable output current is the same as nominal voltage output current.

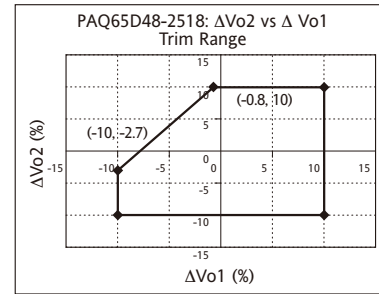
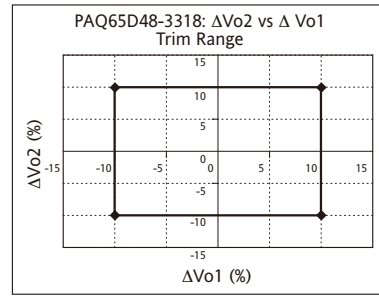
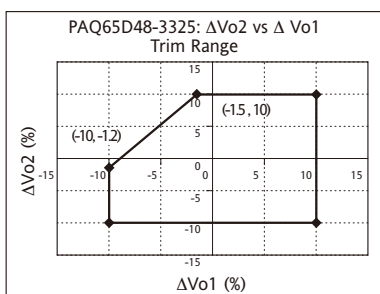
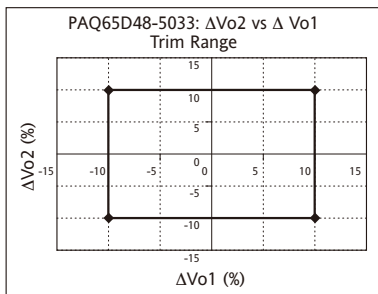

Fig.3-1: PAQ65D48 Standard Model Trim Range

3.1 Standard Model Trim

As mentioned above the standard product comes with 2 independent trim pins to adjust each output voltage individually. V_{o1}/V_{o2} output voltage can be adjusted by connecting an external resistor (R_{adj}) between TRM1/TRM2 to either

- a) V_{o1}/V_{o2} terminal: to adjust to higher output voltage; Fig. 3-2 or
- b) GND terminal: to adjust to lower output voltage; Fig. 3-3.

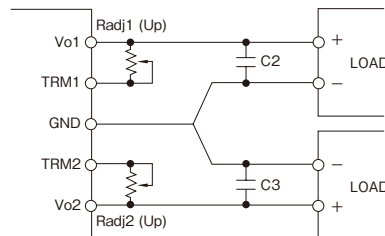

Fig.3-2: Connection for output voltage trim up

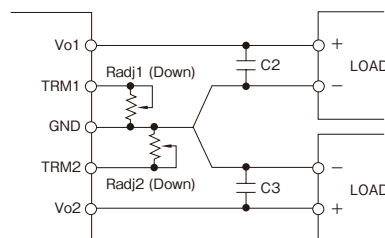

Fig.3-3: Connection for output voltage trim down

The required external resistor values to tune up or down the output voltage for the respective standard models can be found in Page 9 and 10.

3.2 /C Option Model Trim

This option model comes only with one trim pin to adjust both the output voltage simultaneously. Note that the height for this option model is 10.2mm. This model is compatible to other manufacturers power module.

Vo1 and Vo2 output voltage can be adjusted simultaneously by connecting an external resistor (Radj) between TRM to either

- a) GND terminal: to adjust to higher output voltage; Fig.3-4 or
- b) Vo2 terminal: to adjust to lower output voltage; Fig.3-5.

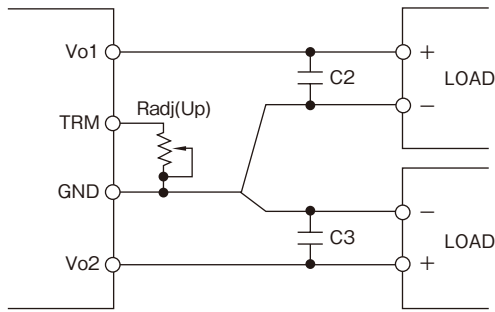

Fig. 3-4: Connection for output voltage trim up

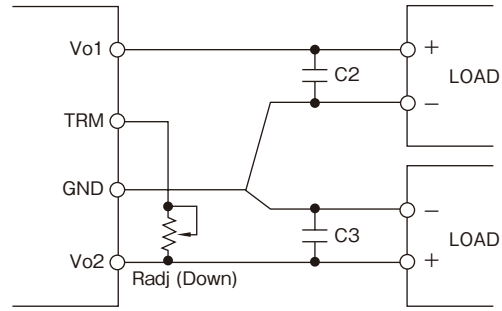

Fig. 3-5: Connection for output voltage trim down

The required external resistor values to tune up or down the output voltage for the respective /C option models can be found in Page 11.

3.1.1 Standard PAQ65D48-5033 model

(i) 5.0V: Output Trim Up

Trim Up ΔVo(%)	1	2	3	4	5	6	7	8	9	10
Radj1-up (kΩ)	837	422	284	215	174	146	126	112	100	91.0

(ii) 3.3V: Output Trim Up

Trim Up ΔVo(%)	1	2	3	4	5	6	7	8	9	10
Radj2-up (kΩ)	459	232	156	118	95.2	80.1	69.3	61.1	54.8	49.8

(iii) 5.0V: Output Trim Down

Trim Down ΔVo(%)	-1	-2	-3	-4	-5	-6	-7	-8	-9	-10
Radj1-down (kΩ)	265	131	86.5	64.2	50.7	41.8	35.4	30.6	26.9	23.9

(iv) 3.3V: Output Trim Down

Trim Down ΔVo(%)	-1	-2	-3	-4	-5	-6	-7	-8	-9	-10
Radj2-down (kΩ)	265	131	86.5	64.2	50.7	41.8	35.4	30.6	26.9	23.9

3.1.2 Standard PAQ65D48-3325 model

(i) 3.3V: Output Trim Up

Trim Up ΔVo(%)	1	2	3	4	5	6	7	8	9	10
Radj1-up (kΩ)	94.2	47.4	31.9	24.1	19.4	16.3	14.1	12.4	11.1	10.1

(ii) 2.5V: Output Trim Up

Trim Up ΔVo(%)	1	2	3	4	5	6	7	8	9	10
Radj2-up (kΩ)	58.3	29.3	19.7	14.8	11.9	10.0	8.63	7.60	6.79	6.15

(iii) 3.3V: Output Trim Down

Trim Down ΔVo(%)	-1	-2	-3	-4	-5	-6	-7	-8	-9	-10
Radj1-down (kΩ)	54.4	26.8	17.6	13.0	10.3	8.42	7.11	6.12	5.36	4.74

(iv) 2.5V: Output Trim Down

Trim Down ΔVo(%)	-1	-2	-3	-4	-5	-6	-7	-8	-9	-10
Radj2-down (kΩ)	54.4	26.8	17.6	13.0	10.3	8.42	7.11	6.12	5.36	4.74

3.1.3 Standard PAQ65D48-3318 model

(i) 3.3V: Output Trim Up

Trim Up ΔVo(%)	1	2	3	4	5	6	7	8	9	10
Radj1-up (kΩ)	301	152	102	77.3	62.4	52.5	45.4	40.0	35.9	32.6

(ii) 1.8V: Output Trim Up

Trim Up ΔVo(%)	1	2	3	4	5	6	7	8	9	10
Radj2-up (kΩ)	120	60.3	40.5	30.6	24.7	20.8	17.9	15.8	14.2	12.8

(iii) 3.3V: Output Trim Down

Trim Down ΔVo(%)	-1	-2	-3	-4	-5	-6	-7	-8	-9	-10
Radj1-down (kΩ)	94.2	46.5	30.6	22.7	17.9	14.7	12.5	10.7	9.42	8.36

(iv) 1.8V: Output Trim Down

Trim Down ΔVo(%)	-1	-2	-3	-4	-5	-6	-7	-8	-9	-10
Radj2-down (kΩ)	94.2	46.5	30.6	22.7	17.9	14.7	12.5	10.7	9.42	8.36



3.1.4 Standard PAQ65D48-2518 model

(i) 2.5V: Output Trim Up

Trim Up ΔV_o (%)	1	2	3	4	5	6	7	8	9	10
Radj1-up (k Ω)	205	103	69.4	52.5	42.4	35.6	30.8	27.2	24.4	22.1

(ii) 1.8V: Output Trim Up

Trim Up ΔV_o (%)	1	2	3	4	5	6	7	8	9	10
Radj2-up (k Ω)	120	60.3	40.5	30.6	24.7	20.8	17.9	15.8	14.2	12.8

(iii) 2.5V: Output Trim Down

Trim Down ΔV_o (%)	-1	-2	-3	-4	-5	-6	-7	-8	-9	-10
Radj1-down (k Ω)	94.2	46.5	30.6	22.7	17.9	14.7	12.5	10.7	9.42	8.36

(iv) 1.8V: Output Trim Down

Trim Down ΔV_o (%)	-1	-2	-3	-4	-5	-6	-7	-8	-9	-10
Radj2-down (k Ω)	94.2	46.5	30.6	22.7	17.9	14.7	12.5	10.7	9.42	8.36

3.2.1 PAQ65D48-5033/C option model

(i) Common Output Trim Up

Trim Up ΔV_o (%)	1	2	3	4	5	6	7	8	9	10
Radj-up (k Ω)	50.0	23.0	14.0	9.2	6.4	4.5	3.1	2.1	1.3	0.0

(ii) Common Output Trim Down

Trim Down ΔV_o (%)	-1	-2	-3	-4	-5	-6	-7	-8	-9	-10
Radj-down (k Ω)	67.0	30.0	17.0	11.0	7.8	5.4	3.7	2.4	1.4	0.0

3.2.2 PAQ65D48-3325/C option model

(i) Common Output Trim Up

Trim Up ΔV_o (%)	1	2	3	4	5	6	7	8	9	10
Radj-up (k Ω)	46.0	20.4	12.1	7.9	5.2	3.5	2.2	1.3	0.61	0.0

(ii) Common Output Trim Down

Trim Down ΔV_o (%)	-1	-2	-3	-4	-5	-6	-7	-8	-9	-10
Radj-down (k Ω)	56.9	25.0	13.8	8.8	5.8	3.8	2.3	1.3	0.43	0.0

3.2.3 PAQ65D48-3318/C option model

(i) Common Output Trim Up

Trim Up ΔV_o (%)	1	2	3	4	5	6	7	8	9	10
Radj-up (k Ω)	13.5	6.2	3.8	2.6	1.9	1.4	1.05	0.79	0.59	0.43

(ii) Common Output Trim Down

Trim Down ΔV_o (%)	-1	-2	-3	-4	-5	-6	-7	-8	-9	-10
Radj-down (k Ω)	15.2	6.9	4.2	2.8	1.98	1.43	1.03	0.74	0.51	0.33

3.2.4 PAQ65D48-2518/C option model

(i) Common Output Trim Up

Trim Up ΔV_o (%)	1	2	3	4	5	6	7	8	9	10
Radj-up (k Ω)	13.5	6.2	3.8	2.6	1.9	1.4	1.05	0.79	0.59	0.43

(ii) Common Output Trim Down

Trim Down ΔV_o (%)	-1	-2	-3	-4	-5	-6	-7	-8	-9	-10
Radj-down (k Ω)	15.2	6.9	4.2	2.8	1.98	1.43	1.03	0.74	0.51	0.33

PAQ

4 Maximum Ripple and Noise

The standard measurement for output ripple and noise is as shown in Fig.4-1. Connect a 22 μ F ceramic capacitor for each output (C2 and C3) at 50mm away from the output terminal. Use a normal probe with 20MHz bandwidth scope to measure the ripple and noise at the position of C2 and C3. Upon measurement of the ripple voltage, make sure that the oscilloscope probe leads are not too long.

Take note that output ripple voltage and output spike noise may vary depending on PCB wiring design. Generally, output ripple voltage and output spike noise can be reduced

by increasing value of external capacitor.

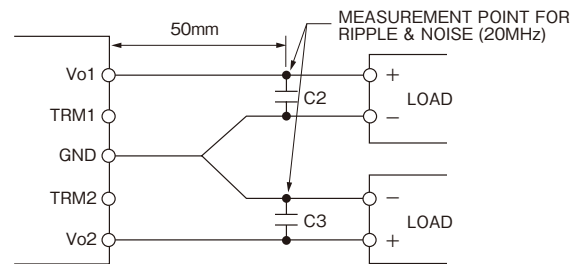

Fig.4-1: Measurement method for ripple and noise

5 Maximum Line Regulation

Maximum line regulation is the maximum value of output voltage change when input voltage is gradually varied within specified input voltage range. The measurement point for the input and output voltage are $\pm V_{in}$, $+V_{o1}$, $+V_{o2}$ and GND (output terminal point) respectively.

6 Maximum Load Regulation

Maximum load regulation is the value of output voltage change when output current is gradually varied within specified output current range. The measurement point for the input and output voltage are $\pm V_{in}$, $+V_{o1}$, $+V_{o2}$ and GND (output terminal point) respectively. When using at dynamic load mode, the output voltage fluctuation might increase.

7 Over Current Protection (OCP)

This power module has built-in OCP function. Output will recover when short circuit or overload conditions are released immediately. OCP setting value is fixed and therefore, can not be externally adjusted. Also, take note, when output voltage drops down below lower side of adjustment range for 20ms - 50ms by output short circuit or over load conditions, output might be shut down and latch.

Output can be recovered by manual reset (≥ 400 ms) of the control ON/OFF terminal or by turning input line off and then turning it on again. Auto-restart (/V option) from OCP shutdown is available; please refer to the next section.

8 Over Voltage Protection (OVP)

This power module has built-in OVP function. OVP set point is a percentage of nominal output voltage value. When output voltage exceeds OVP set point, output voltage shuts down. OVP set point is fixed and therefore can not be changed. When OVP is triggered, output can be recovered by i) turning input line off and then turning it on again after the input voltage drop below the value indicated below, or ii) by manual reset of the control ON/OFF terminal (≥ 400 ms).

Input Voltage for OVP reset: 26VDC and below

/V Option (auto-restart)

The /V optional model will re-start with delay of 400ms~900ms after shutdown by OCP or OVP triggering. When over voltage and over current are removed, output will recover normally.

9 Over Thermal Protection (OTP)

This power module has built-in OTP function. This function operates and shuts down the output when temperature of the power module rises excessively. The power module will recover automatically when the unit cools down. Take note that OTP will operate again unless the cause of abnormal heat of the power module is eliminated.

For the details of OTP, refer to the clause of "Mounting method and Thermal Condition"

10 ON/OFF Control (CNT Terminal)

Without turning the input supply on and off, the output can be enabled and disabled using this function. This function also can be used for output sequence of multiple modules.

ON/OFF control circuit is on the primary side (the input side), CNT Terminal pin. For secondary control, isolation can be achieved through the use of a opto coupler or relay.

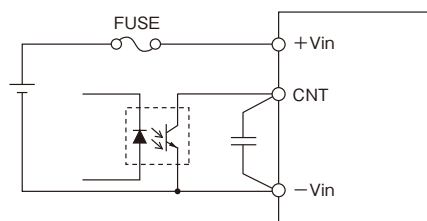

Fig.10-1 : CNT connection

There are 2 types of option which are negative logic (standard model) and positive logic (/P Option).

a) Negative Logic (Standard Model)

CNT Level to $-V_{in}$ Terminal	Output Status
H Level ($H \geq 2V$) or Open	OFF
L Level ($L \leq 0.8V$) or Short	ON

b) Positive Logic (/P Option)

CNT Level to $-V_{in}$ Terminal	Output Status
H Level ($H \geq 2V$) or Open	ON
L Level ($L \leq 0.8V$) or Short	OFF

- For standard model, when control function is not used, CNT terminal is shorted to $-V_{in}$ terminal.
- When using long wiring, for prevention of noise, attach a $0.1\mu F$ capacitor between CNT Terminal and $-V_{in}$ terminal.
- At L level, maximum source current from CNT Terminal to $-V_{in}$ terminal is 0.5mA.
- The maximum CNT Terminal voltage when it is opened is 6V.
- When the voltage at CNT pin is between 0.8V and 2V, the output voltage is undefined.

11 Operating Ambient Temperature

The operating ambient temperature is from $-40^{\circ}C \sim 85^{\circ}C$. However, the output load should be derated accordingly to the ambient temperature and airflow speed. (Refer to Mounting Method & Thermal Condition). There is no restriction on mounting direction but there should be enough consideration for airflow so that heat does not accumulate around the power module vicinity.

Determine external components configuration and mounting direction on PCB such that airflow through the power module from force air or convection cooling is not blocked.

12 Operating Ambient Humidity

Take note that moisture could lead to power module abnormal operation or damage.

13 Storage Ambient Temperature

Abrupt temperature change would cause condensation built-up that leads to poor solderability of terminals of the power module.

14 Storage Ambient Humidity

High temperature and humidity can cause the terminals on the module to oxidize. The quality of the solder will become worse.

15 Cooling Method

Forced air cooling is recommended. Convection cooling is also possible. For the details of derating, refer to “Mounting Method and Thermal condition”.

16 Ambient Temperature vs. Output Voltage Drift

Temperature coefficient is defined as the rate of voltage change when ambient temperature is changed during operation.

17 Withstand Voltage

This power module is designed to have a withstand voltage of 1.5kVDC between input to output. When conducting withstand voltage test during incoming inspection, be sure to apply DC voltage. Also, set the current limit value of the withstand voltage testing equipment to 10mA. Be sure to avoid conducting test with AC voltage because this would cause power module damage. Furthermore, avoid throw in or shut off of the testing equipment when applying or when shutting down the test voltage. Instead, gradually increase or decrease the applied voltage. Take note especially not to use the timer of the test equipment because when the timer switches the applied voltage off, impulse voltage which has several times the magnitude of the applied voltage is generated causing damage to the power module.

For testing, short all the input side together and output side together as shown in the diagram below.

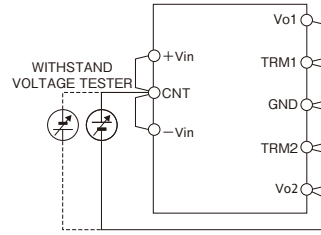

Test condition: 1.5kVDC 1minute (10mA)
Fig.17-1: Withstand Voltage Test for Input-Output

18 Insulation Resistance

Use DC insulation tester (MAX 500V) between output and input. Insulation resistance value is 100Mohm and above at 500VDC applied voltage.

Make sure that during testing, the isolation testers does not produce a high pulse when the applied voltage is varied. Ensure that the tester is fully discharged after the test.

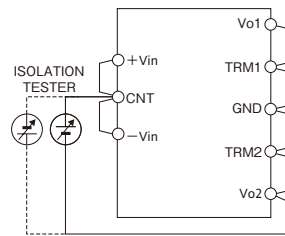

Fig.18-1: Isolation test

19 Vibration

Vibration of power module is defined in case of mounting on PCB.

20 Shock

Value for the conditions of out shipping and packaging.

3. Mounting Method and Thermal Condition

1 Output derating

There is no restriction on mounting direction but there should be enough consideration for airflow so that heat does not accumulate around the power module vicinity. Determine external components configuration and mounting direction on PCB such that air flow through power module from forced air or convection cooling is not blocked. Take note, output power derating is needed as shown in followings. (Refer to output derating by ambient temperature.)

For actual application with difficulty of air flow measurement, it is recommended to measure MOSFET Q15 temperature in order to ensure the power module operates within derating curve. (Refer to output derating by MOSFET Q15 temperature).

The output derating by ambient temperature curves provided is based on the below set-up condition. It is therefore advisable to do actual thermal measurement on MOSFET Q15 before confirming the thermal design.

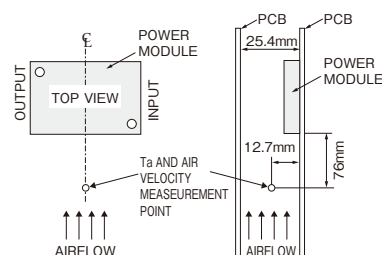

Fig.1-1: Mounting method

1.1 Output Derating by ambient temperature

- (a) Channel 1 Output Current (Io1) = 30% rated load
- Condition: Vin = 48VDC
- Io1: PAQ65D48-5033 = 3.6A (fixed)
- Other models = 30% Rated Load (fixed)

- (b) Channel 1 Output Current (Io1) = 50% rated load
- Condition: Vin = 48VDC
- Io1: PAQ65D48-5033 = 6A (fixed)
- Other models = 50% Rated Load (fixed)

Note : Derating is done by fixed Channel 1 (Io1) output current to 30% , except PAQ65D48-5033 model which is set to 3.6A, and reduce Channel 2 (Io2) output current.

Note : Derating is done by fixed Channel 1 (Io1) output current to 50% , except PAQ65D48-5033 model which is set to 6A, and reduce Channel 2 (Io2) output current.

PAQ65D48-5033 Output current derating curve
5V=3.6A (fixed), 3.3V=14.2A (variable)

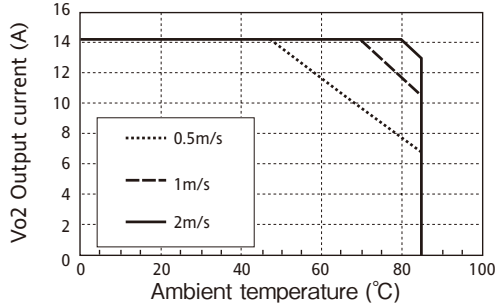

Fig. 1-2 : PAQ65D48-5033 Output Derating

PAQ65D48-5033 Output current derating curve
5V=6A (fixed), 3.3V=10.6A (variable)

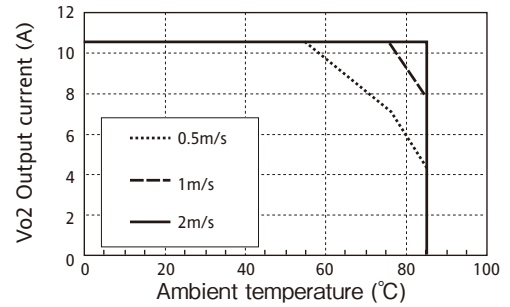

Fig. 1-6 : PAQ65D48-5033 Output Derating

PAQ65D48-3325 Output current derating curve
3.3V=4.5A (fixed), 2.5V=13.5A (variable)

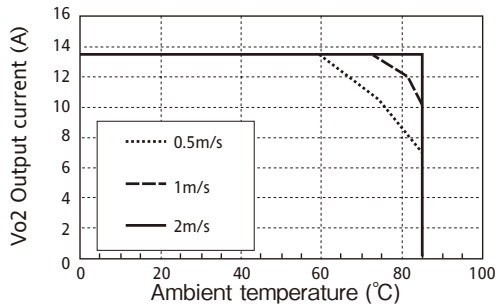

Fig. 1-3 : PAQ65D48-3325 Output Derating

PAQ65D48-3325 Output current derating curve
3.3V=7.5A (fixed), 2.5V=9.9A (variable)

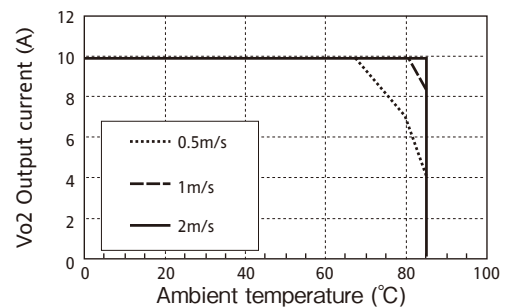

Fig. 1-7 : PAQ65D48-3325 Output Derating

PAQ65D48-3318 Output current derating curve
3.3V=4.5A (fixed), 1.8V=13.5A (variable)

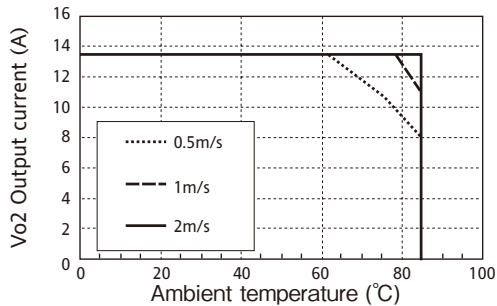

Fig. 1-4 : PAQ65D48-3318 Output Derating

PAQ65D48-3318 Output current derating curve
3.3V=7.5A (fixed), 1.8V=10.5A (variable)

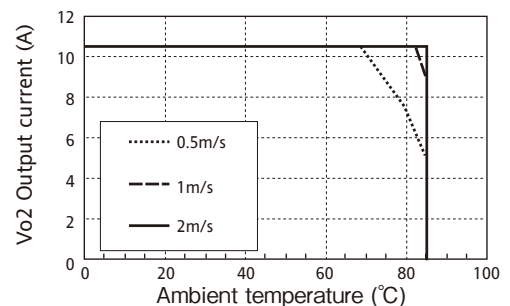

Fig. 1-8 : PAQ65D48-3318 Output Derating

PAQ65D48-2518 Output current derating curve
2.5V=4.5A (fixed), 1.8V=13.5A (variable)

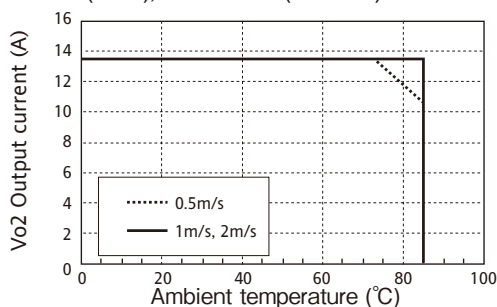

Fig. 1-5 : PAQ65D48-2518 Output Derating

PAQ65D48-2518 Output current derating curve
2.5V=7.5A (fixed), 1.8V=10.5A (variable)

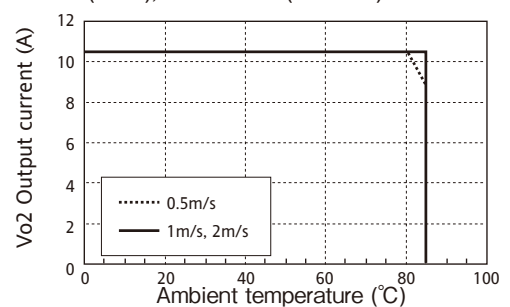

Fig. 1-9 : PAQ65D48-2518 Output Derating

PAQ

1.2 Output derating by MOSFET Q15

It is recommended to use the output derating curve by measuring MOSFET Q15 temperature if there is difficulty in taking the actual airflow and ambient temperature in actual application. Fig.1-10 shows the position of MOSFET Q15 for thermal measurement. Connect a thermocouple at the center of this device body. Make sure that at any operating condition, the temperature for this device should not exceed 125°C as shown in Figure 1-11 output derating curve. If exceeded, the Over Thermal Protection (OTP) of power module will operate and output will shutdown.

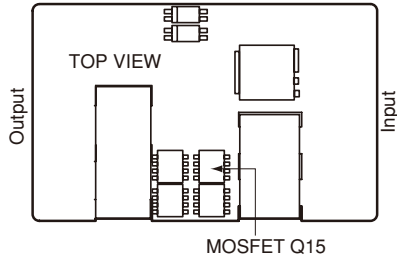

Fig.1-10: MOSFET Q15 Position

● Output derating curve with respect to Q15

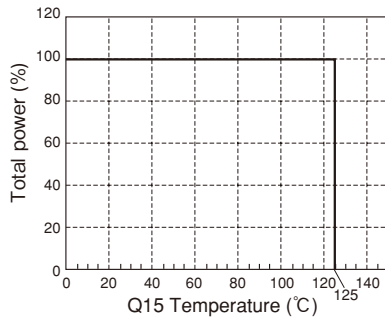

Fig.1-11: PAQ65D48 Output Derating curve by MOSFET Q15 Temperature

2 Mounting Method

(a) Prohibition area of pattern wiring

For the standard model, avoid wiring pattern on PCB in shaded area, as shown in Figure 2-1 as it may cause insulation problem. Since the power module may be influenced by noise, care must be taken when wiring the signal line on the unshaded area. Note that for /C option, it is not necessary to have kept out area for PCB pattern.

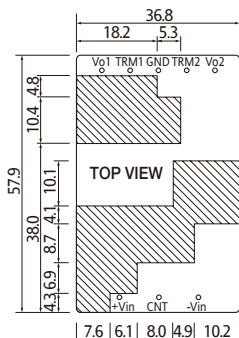

Fig.2-1 : Prohibition area of wiring pattern

(b) Mounting hole on PCB

Below is the recommended diameter of hole and land of PCB.

Type	PAQ65D48
Terminal Pin	φ 1.0mm
Hole Diameter	φ 1.3mm
Land Diameter	φ 2.8mm

For position of the holes, see outline drawing of the power module.

(c) Recommended Material of PCB

Recommended materials of the printed circuit board is double sided glass epoxy with through holes. (thickness: t=1.6mm)

(d) Output Pattern Width

When several to tens amperes of current flows to output pattern, voltage would drop and heat generation would be higher for narrow pattern. Relationship between current and pattern width changes depending on material of printed circuit board, thickness of conductor and temperature rise allowance. Fig. 2-2 shows an example of a 35μm copper glass epoxy printed circuit board. For example, when 5A of current flows and temperature rise below 10°C are expected, pattern width shall be more than 4.2mm with 35μm copper plate (generally 1mm/A is standard). Confirmation is definitely necessary for designing because characteristics shown in Fig. 2-2 depend on manufacturers of printed circuit board.

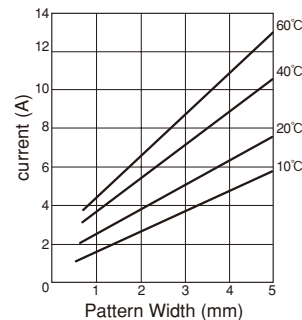

Fig.2-2 Characteristic of current allowance

3 Recommended Soldering Condition

Recommended soldering temperature is as follows.

- (1) Soldering dip: 260°C within 6 seconds
Pre-heat condition: 110°C 30 - 40 seconds
- (2) Soldering iron: 350°C within 3seconds

4 Recommended Cleaning Condition

Recommended cleaning condition after soldering is as follows.

- Cleaning solvent: IPA (isopropyl alcohol)
- Cleaning Procedure: Use brush and dry the solvent completely.

Note: For other cleaning methods, contact us.

3. Before concluding power module damage

Verify following items before concluding power module damage.

- 1) No output voltage
 - Is specified input voltage applied?
 - Are the ON/OFF control terminal (CNT terminal), output voltage trimming terminal (TRIM) correctly connected?
 - For cases where output voltage adjustment is used, is the resistor or variable resistor setting, connections correctly done?
 - Are there no abnormalities in the output load used?
- 2) Output voltage is high
 - For cases where output voltage adjustment is used, is the resistor or volume setting, connections correctly done?
- 3) Output voltage is low
 - Is specified input voltage applied?
 - For cases where output voltage adjustment is used, is the resistor or variable resistor setting, connections correctly done?
 - Are there no abnormalities in the output load used?
- 4) Load regulation and line regulation is large
 - Is specified input voltage applied?
 - Are the input terminals and the output terminals firmly connected?
 - Is the input or output wire too thin?
- 5) Output ripple voltage is large
 - Is the measuring method used the same or equivalent with the specified method in the Application Notes?
 - Is the input ripple voltage value within the specified value?

TDK-Lambda

X-ON Electronics

Largest Supplier of Electrical and Electronic Components

Click to view similar products for [Isolated DC/DC Converters](#) category:

Click to view products by [TDK-Lambda](#) manufacturer:

Other Similar products are found below :

[ESM6D044440C05AAQ](#) [FMD15.24G](#) [PSL486-7LR](#) [Q48T30020-NBB0](#) [JAHW100Y1](#) [SPB05C-12](#) [SQ24S15033-PS0S](#) [18952](#) [19-130041](#)
[CE-1003](#) [CE-1004](#) [GQ2541-7R](#) [RDS180245](#) [MAU228](#) [J80-0041NL](#) [DFC15U48D15](#) [XGS-0512](#) [XGS-1205](#) [XGS-1212](#) [XGS-2412](#) [XGS-2415](#) [XKS-1215](#) [06322](#) [NCT1000N040R050B](#) [SPB05B-15](#) [SPB05C-15](#) [L-DA20](#) [DCG40-5G](#) [QME48T40033-PGB0](#) [XKS-2415](#) [XKS-2412](#)
[XKS-2405](#) [XKS-1212](#) [XKS-1205](#) [XKS-0515](#) [XKS-0505](#) [XGS-2405](#) [XGS-1215](#) [XGS-0515](#) [PS9Z-6RM4](#) [73-551-5038I](#) [AK1601-9RT](#) [VI-R5022-EXWW](#) [PSC128-7iR](#) [RPS8-350ATX-XE](#) [DAS1004812](#) [VI-LJ11-iz](#) [PQA30-D24-S24-DH](#) [VI-M5F-CQ](#) [VI-LN2-EW](#)