

1200 to 2500W Front End Power Supplies

Features

- ◆ 1U High
- ◆ Up to 10,000W in 19" Rack
- ◆ Hot Swap Capable
- ◆ High Efficiency
- ◆ Full array of signals

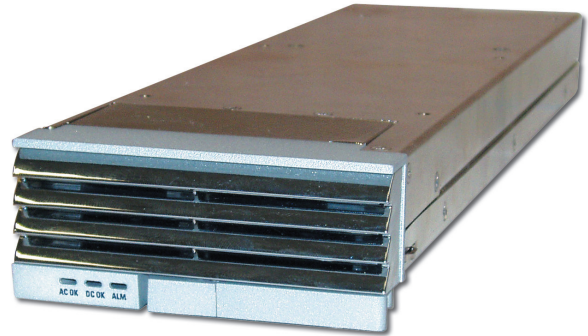

Key Market Segments & Applications



Specifications		TH120012 ⁽⁵⁾	TH120024	TH120048	TH250048 ⁽⁵⁾
Nominal Voltage	V	12	24	48	48
Output Voltage Range	VDC	10.5-14	21-28	42-56	42-56
Total Regulation	%	±1%			
Output Current	A(max)	100	50	25	50
Current limit	(1) A	120	60	30	60
Short Circuit Current	%	150	75	37	75
Output Noise	mV	250mV peak to peak (10kHz to 20MHz)			
Output Rise Time	ms	100-400 ms			
Dynamic Response	%	3% in 10ms for a 10-100% load change			
Overvoltage Protection	(1) VDC	13-15	27-30	50-60	50-60
Load Sharing	%	±5%			
I2C Programming	-	Set output Volt, Monitors AC present, Converter OK, Thermal Profile, Fan fail			
Signals (opto isolated)	(4) -	AC Fail, Module Alarm, Temp Alarm			
Remote On/Off	V	Shuts down outputs by applying 3.3 to 5V			
Auxiliary Output	(3) -	12V@100mA			
AC Input	VAC	90-264	90-264	90-264	180-264
Input Frequency	Hz	47-63			
Power Factor	-	0.99 typ. @ 230VAC, full load, meets EN61000-3-2			
Inrush Current	(2) A	30 Amps peak			
Efficiency (at full load)	%	88	90	92	93
Immunity	-	EN61000-4-2,-3,-4,-5,-6,-8,-11			
EMC (conducted and radiated)	-	EN55022, Level B, FCC Class B			
Operating Temperature	°C	-40 to 70, derate linearly to 60% load above 50°C			
Storage Temperature	°C	-40 to 85			
Humidity	%	5 to 95 (non-condensing)			
Altitude	ft	-200 to 8000			
Shock	G	IEC68-2-27, Mil-STD-810E, 20G			
Vibration	Hz	IEC68-2-64 (random) 20-2000Hz, 30 minutes			
Safety Agency	-	UL60950, CSA 22.2 No. 60950-00, EN60950, CE Mark			
Size (L x W x H)	in.	14.25 x 4.00 x 1.69 (stand alone), 16.30 x 17.31 x 1.7 (THR4 Rack)			
Weight	lbs	Power Module 6lbs, Rack 9lbs			
Warranty	yrs	Two Years			

- 1 Adjustable via i2C or through Lambda Network Interface Card
- 2 Excludes Xcaps in the EMC input filter
- 3 Output operates independent of main DC output and is referenced to (-)Vout
- 4 All three signals share a common return - logic ground
- 5 Use rack model THR400

THR4 Rack Outline Drawing

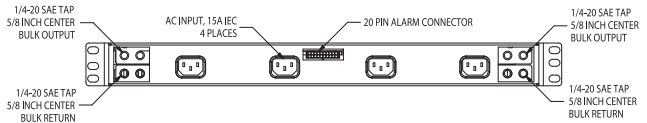
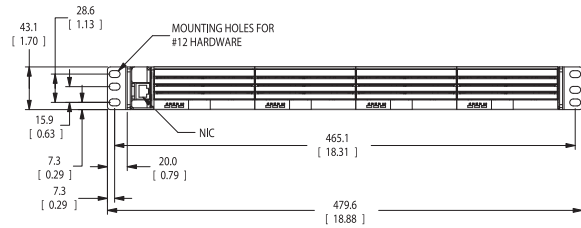
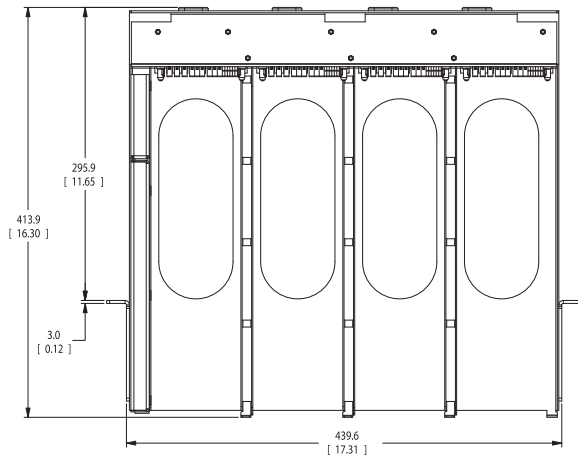

TH Module Outline Drawing

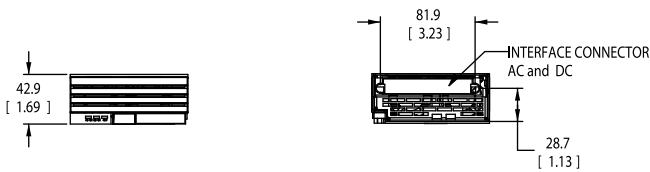
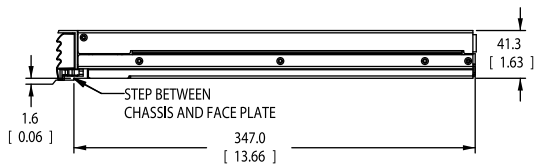
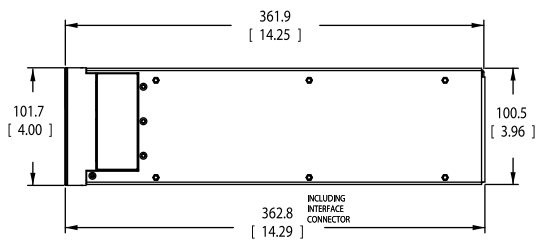

Models

Model	Output Voltage	Output Current	Maximum Power
TH120012 ⁽⁵⁾	12V	100A	1200W
TH120024	24V	50A	1250W
TH120048	48V	25A	1250W
TH250048 ⁽⁵⁾	48V	50A	2500W
THR4	19" Rack holds up to 4 TH Modules; 120A maximum output current.		
THR400	19" Rack holds up to 4 TH modules; 400A maximum output current. Screw terminal input connection.		
THRBP	Blanking panel for one module slot.		
THR4NIC	Network interface card for 48V systems.		
THR4NIC12	Network interface card for 12V systems.		
THR4NIC24	Network interface card for 24V systems.		
TLRC01	Signal cable		

Alarm Connector

Mating Housing	Molex MicroFit 43025-2000
Mating Terminal	Molex MicroFit 43030-0002

For Additional Information, please visit us.tdk-lambda.com/lp/products/th-series.htm



Other Industrial Products

PX, CC-E, PAQ, PAH, PAF	DC-DC Converters
FPS1000	1U 1kW to 3kW Low Cost Front End

X-ON Electronics

Largest Supplier of Electrical and Electronic Components

Click to view similar products for [Rack Mount Power Supplies](#) category:

Click to view products by [TDK-Lambda](#) manufacturer:

Other Similar products are found below :

[HFE2500BP](#) [PET1300-12-054NAE](#) [HFE1600BP](#) [73-311-0001](#) [73-317-0148](#) [73-495-0233](#) [750-1016](#) [SFP450-S101G](#) [FUP550SNRPS](#)
[VRA.00335.0](#) [VRA.00334.0](#) [VRA.00333.0](#) [HFE1600-KIT](#) [CC109146503](#) [RKP-1UI](#) [PFE1100-12-054ND](#) [FND300-1012G](#) [73-951-0001T](#)
[73-954-0001C](#) [DS550DC-3](#) [DRP-3200-48](#) [RCP-2000-24](#) [TSR10](#) [TET2000-12-086NA](#) [PET2000-12-074RA](#) [RCP-MU](#) [RCP-3K1UI-12](#) [605-](#)
[10144-2AC](#) [6609006-5](#) [D1U54P-W-1200-12-HC4PC](#) [DS450DC-3](#) [DS650DC-3](#) [HPR12K-00-001](#) [LCM1500L-T-4](#) [LCM300Q-T](#) [LCM300W-](#)
[T-4](#) [LCM600N-T-4-A](#) [FNP600-48G](#) [FNR-3-48G](#) [FNR-5-12G](#) [PFS1200-12-054RAH](#) [PFS1200-12-054RD](#) [SPSPFE3-05G](#)
[TET3200-12-069RA](#) [IEC-A-1](#) [FXX1600PCRPS](#) [915606](#) [DHP-1UT-A](#) [DRP-3200-24](#) [RCP-1000-12](#) [RCP-1000-12-C](#)