

# VS-E SERIES

Single Output 50 - 150W

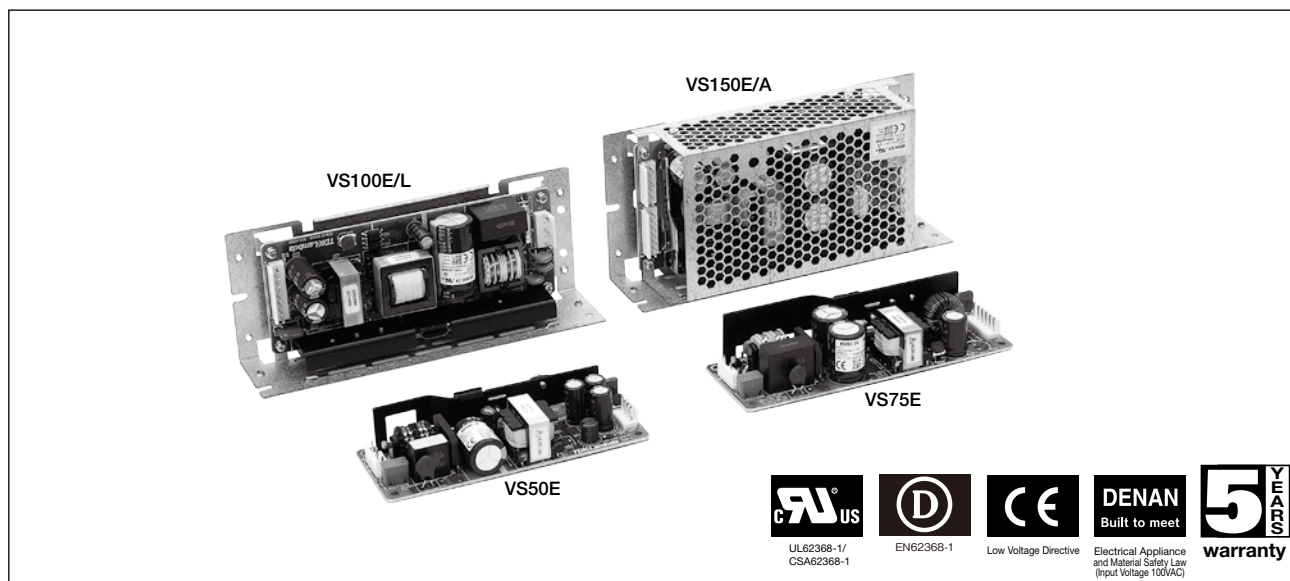

## ■ Features

- High efficiency and low standby power.
- 30% Miniaturization from previous models.
- 100% load at 50°C, suitable for industrial equipment.
- 5 Years warranty (conditions applied)

## ■ Model name identification method

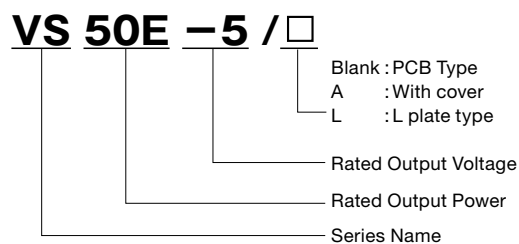

## ■ Applications



## ■ Conformity to RoHS Directive

## ■ Product line up

Model	VS50E 50W		VS75E 75W		VS100E 100W		VS150E 150W	
	Output Current	Efficiency(Typ)	Output Current	Efficiency(Typ)	Output Current	Efficiency(Typ)	Output Current	Efficiency(Typ)
3.3V	10A	80%	15A	80%	20A	80%	30A	80%
5V	10A	85%	15A	85%	20A	85%	30A	86%
12V	4.3A	85%	6.3A	85%	8.5A	85%	12.5A	87%
15V	3.5A	85%	5.0A	85%	7.0A	85%	10.0A	87%
24V	2.5A	85%	3.2A	86%	4.3A	86%	6.3A	87%
48V	1.3A	87%	1.6A	87%	2.2A	87%	3.2A	88%

## ■ Option line up

Model	VS50E 50W				VS75E 75W				VS100E 100W				VS150E 150W			
	/A	/L	/CO2	/FV	/A	/L	/CO2	/FV	/A	/L	/CO2	/FV	/A	/L	/CO2	/FV
3.3V	○	○	○	-	○	○	○	-	○	○	○	-	○	○	○	-
5V	○	○	○	-	○	○	○	-	○	○	○	-	○	○	○	-
12V	○	○	○	○	○	○	○	○	○	○	○	○	○	○	○	○
15V	○	○	○	-	○	○	○	-	○	○	○	-	○	○	○	-
24V	○	○	○	○	○	○	○	○	○	○	○	○	○	○	○	○
48V	○	○	○	○	○	○	○	○	○	○	○	○	○	○	○	○

# VS50E Specifications

ITEMS/UNITS		MODEL	VS50E-3	VS50E-5	VS50E-12	VS50E-15	VS50E-24	VS50E-48	
Input	Voltage Range	(*2) V	AC 85 - 132						
	Frequency	(*2) Hz	47 - 63						
	Efficiency (Typ)	(*1) %	80	85				87	
	Current (Typ)	(*1) A	0.9	1.1			1.3		
	Inrush Current (Typ)	(*1)(*11) A	30 at Cold Start						
	Leakage Current	(*8) mA	Less than 0.5						
Output	Nominal Voltage	VDC	3.3	5	12	15	24	48	
	Maximum Current	A	10		4.3	3.5	2.5	1.3	
	Maximum Power	W	33.0	50.0	51.6	52.5	60.0	62.4	
	Maximum Line Regulation	(*3)(*4) mV	20		48	60	96	192	
	Maximum Load Regulation	(*3)(*5) mV	40		96	120	150	240	
	Temperature Coefficient	(*3)	Less than 0.02% / °C						
	Maximum Ripple & Noise(0≤Ta≤70°C)	(*3) mVp-p	120			150		200	
	Maximum Ripple & Noise(-10≤Ta<0°C)	(*3) mVp-p	160			180		240	
	Hold-up Time (Typ)	(*1) ms	20						
Function	Voltage Adjustable Range	(*12) VDC	2.97 - 3.63	4.5 - 5.5	10.8 - 13.2	13.5 - 16.5	21.6 - 26.4	43.2 - 52.8	
	Over Current Protection	(*6) A	10.5 -		4.51 -	3.67 -	2.62 -	1.36 -	
	Over Voltage Protection	(*7) VDC	3.80 - 4.46	5.75 - 6.75	13.8 - 16.2	17.3 - 20.3	27.6 - 32.4	55.2 - 64.8	
	Parallel Operation		-						
	Series Operation		Possible						
Environment	Operating Temperature	(*9) °C	Convection : -10 - +70 (-10 - +50:100%, +60:70%, +70:20%)						
	Storage Temperature	°C	-30 - +85						
	Operating Humidity	%RH	30 - 90 (No dewdrop)						
	Storage Humidity	%RH	10 - 95 (No dewdrop)						
	Vibration		At no operating, 10 - 55Hz (Sweep for 1min) 19.6m/s <sup>2</sup> Constant, X,Y,Z 1hour each.						
	Shock		Less than 196.1m/s <sup>2</sup>						
	Cooling		Convection Cooling						
Isolation	Withstand Voltage		Input - FG : 2kVAC (10mA), Input - Output : 2kVAC (10mA) Output - FG : 500VAC (20mA) for 1min						
	Isolation Resistance		More than 100MΩ at 25°C and 70%RH Output - FG : 500VDC						
Standards	Safety Standards		Approved by UL62368-1, CSA62368-1, EN62368-1, EN50178(OV II), UL60950-1, CSA60950-1, EN60950-1. (Expire date of 60950-1: 20/12/2020) Designed to meet Den-an Appendix 12 (J60950-1).						
	EMI		Designed to meet EN55011/EN55032-B, FCC-B, VCCI-B						
	Immunity		Designed to meet IEC61000-4-2(Level 2,3), -3(Level 3), -4(Level 3), -5(Level 2,3), -6(Level 3), -8(Level 4), -11						
Mechanical	Weight (Typ)	g	150						
	Size (W×H×D)	(*10) mm	50 x 23 x 132 ( Refer to Outline Drawing )						

\*Read instruction manual carefully, before using the power supply unit.

(\*1) At 100VAC, Ta=25°C, nominal output voltage and maximum output power.

(\*2) For cases where conformance to various safety specs (UL, CSA, EN) are required, to be described as 100 - 120VAC(50/60Hz).

(\*3) Please refer to Fig. A for measurement of line & load regulation and ripple voltage.

(\*4) 85 - 132VAC, constant load.

(\*5) No load-Full load, constant input voltage.

(\*6) Fold back current limit with automatic recovery. Avoid to operate at over load or short circuit condition for more than 30seconds.

(\*7) OVP circuit will shut the output down, manual reset (Re power on).

(\*8) Measured by the each measuring method of UL, CSA, EN and DENAN(at 60Hz), Ta=25°C.

(\*9) Ratings - Derating at standard mounting. Refer to output derating curve(A239-01-02\_).

- Load (%) is percent of maximum output power or maximum output current, whichever is greater.

(\*10) Not include lead length on solder side.

(\*11) Inrush Current suppressors type. Limits vary according to ambient temperature and in case of re-entry.

(\*12) /FV option is for fixed output voltage.

# Outline Drawing

VS50E Standard Specification, /CO2, /FV

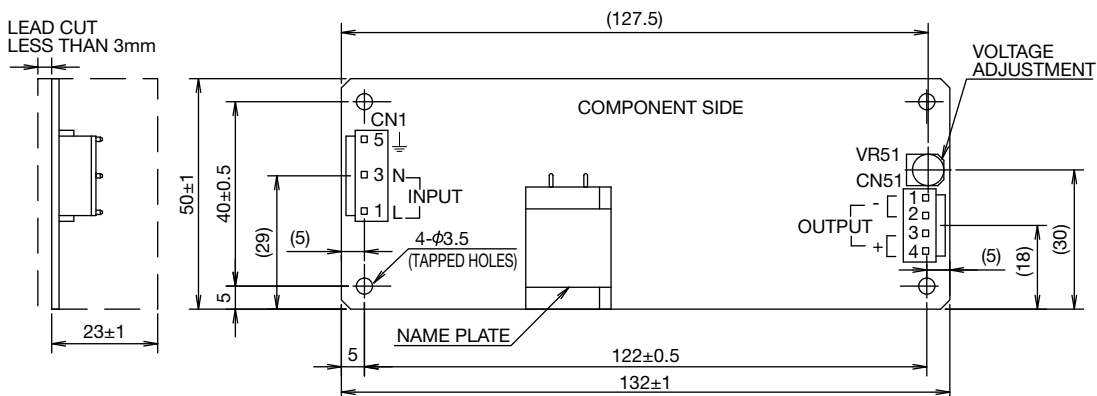

**CONNECTOR USED**

PART DESCRIPTION	PART NAME	MANUFACT	QTY
PIN HEADER (INPUT SIDE CN1)	B3P5-VH(LF)(SN)	J.S.T.	1
PIN HEADER (OUTPUT SIDE CN51)	B4P-VH(LF)(SN)	J.S.T.	1

\* OUTPUT CURRENT OF EACH CONNECTOR PIN MUST BE LESS THAN 5A.

**MATCHING HOUSINGS & PIN (NOT INCLUDED WITH THE PRODUCT.)**

PART DESCRIPTION	PART NAME	MANUFACT	QTY
SOCKET HOUSING (CN1)	VHR-5N	J.S.T.	1
SOCKET HOUSING (CN51)	VHR-4N	J.S.T.	1
Terminal pin	SVH-21T-P1.1	J.S.T.	7
	BVH-21T-P1.1		
HAND CRIMPING TOOL	YC-160R	J.S.T.	-

**OPEN HARNESS**

	PART NAME
INPUT	HA-2-IN
OUTPUT	HA-3-OU

**VS50E/A**

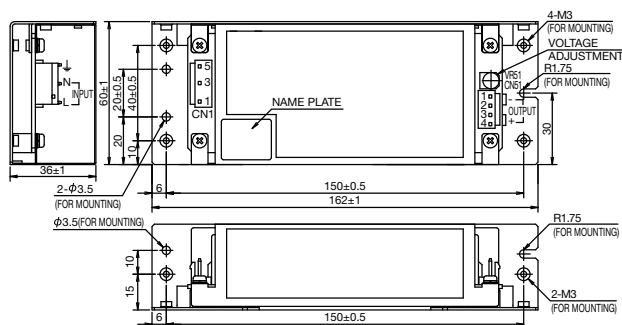

**VS50E/L**

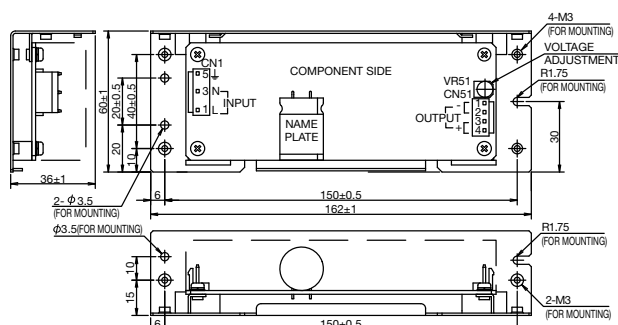

# Output Derating

VS50E Standard Specification, /CO2, /FV, /L  
VS50E-3, -5, -12, -15, -24

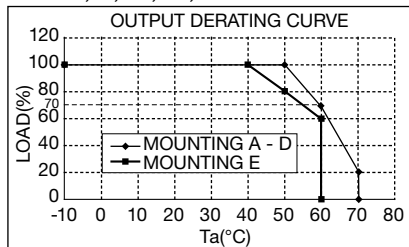

VS50E-48

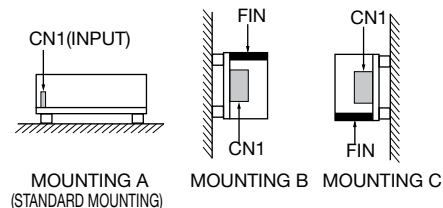
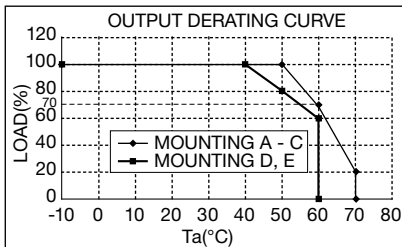

VS50E/A  
VS50E-3/A, -5/A, -12/A, -15/A, -24/A

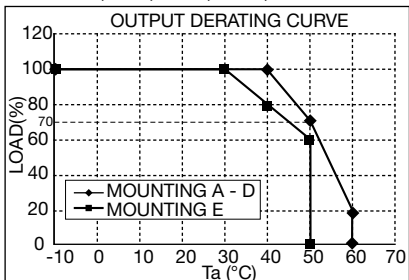

VS50E-48/A

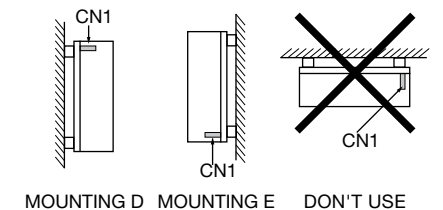
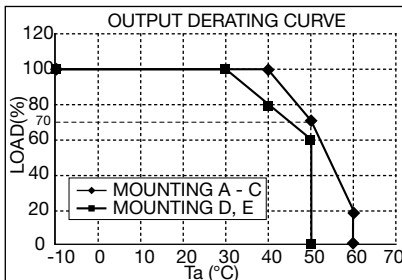

## VS75E Specifications

ITEMS/UNITS		MODEL	VS75E-3	VS75E-5	VS75E-12	VS75E-15	VS75E-24	VS75E-48	
Input	Voltage Range	(*2) V	AC 85 - 132						
	Frequency	(*2) Hz	47 - 63						
	Efficiency (Typ)	(*1) %	80	85			86	87	
	Current (Typ)	(*1) A	1.1	1.6					
	Inrush Current (Typ)	(*1)(*12) A	30A at Cold Start						
	Leakage Current	(*9) mA	Less than 0.5						
Output	Nominal Voltage	VDC	3.3	5	12	15	24	48	
	Maximum Current	A	15		6.3	5.0	3.2	1.6	
	Maximum Power	W	49.5	75.0	75.6	75.0	76.8		
	Maximum Line Regulation	(*3)(*5) mV	20		48	60	96	192	
	Maximum Load Regulation	(*3)(*6) mV	40		96	120	150	240	
	Temperature Coefficient	(*3)	Less than 0.02% / °C						
	Maximum Ripple & Noise(0≤Ta≤70°C)	(*3)(*4) mVp-p	120		150			200	
	Maximum Ripple & Noise(-10≤Ta<0°C)	(*3)(*4) mVp-p	160		180			240	
	Hold-up Time (Typ)	(*1) ms	20						
Function	Voltage Adjustable Range	(*13) VDC	2.97 - 3.63	4.5 - 5.5	10.8 - 13.2	13.5 - 16.5	21.6 - 26.4	43.2 - 52.8	
	Over Current Protection	(*7) A	15.7 -		6.61 -	5.25 -	3.36 -	1.68 -	
	Over Voltage Protection	(*8) VDC	3.80 - 4.46	5.75 - 6.75	13.8 - 16.2	17.3 - 20.3	27.6 - 32.4	55.2 - 64.8	
	Parallel Operation		-						
Environment	Series Operation		Possible						
	Operating Temperature	(*10) °C	Convection : -10 - +70 (-10 - +50:100%, +60:70%, +70:20%)						
	Storage Temperature	°C	-30 - +85						
	Operating Humidity	%RH	30 - 90 (No dewdrop)						
	Storage Humidity	%RH	10 - 95 (No dewdrop)						
	Vibration		At no operating, 10 - 55Hz (Sweep for 1min) 19.6m/s <sup>2</sup> Constant, X, Y, Z 1hour each.						
	Shock		Less than 196.1m/s <sup>2</sup>						
	Cooling		Convection Cooling						
Isolation	Withstand Voltage		Input - FG : 2kVAC (10mA), Input - Output : 2kVAC (10mA) Output - FG : 500VAC (20mA) for 1min						
	Isolation Resistance		More than 100MΩ at 25°C and 70%RH Output - FG : 500VDC						
Standards	Safety Standards		Approved by UL62368-1, CSA62368-1, EN62368-1, EN50178(OV II), UL60950-1, CSA60950-1, EN60950-1. (Expire date of 60950-1: 20/12/2020) Designed to meet Den-an Appendix 12 (J60950-1).						
	EMI		Designed to meet EN55011/EN55032-B, FCC-B, VCCI-B						
	Immunity		Designed to meet IEC61000-4-2(Level 2,3), -3(Level 3), -4(Level 3), -5(Level 2,3), -6(Level 3), -8(Level 4), -11						
Mechanical	Weight (Typ)	g	200						
	Size (W×H×D)	(*11) mm	50 x 29 x 150 ( Refer to Outline Drawing )						

\*Read instruction manual carefully, before using the power supply unit.

(\*1) At 100VAC, Ta=25°C, nominal output voltage and maximum output power.

(\*2) For cases where conformance to various safety specs (UL, CSA, EN) are required, to be described as 100 - 120VAC(50/60Hz).

(\*3) Please refer to Fig. A for measurement of line & load regulation and ripple voltage.

(\*4) For start up at low ambient temperature and low input voltage, output ripple noise might not meet specification.

However, there is no overshoot at start up and output ripple noise specification can be met after one second.

(\*5) 85 - 132VAC, constant load.

(\*6) No load-Full load, constant input voltage.

(\*7) 3.3, 5V model : Constant current limit and hiccup with automatic recovery.

12 - 48V model : Constant current limit with automatic recovery.

Avoid to operate at over load or short circuit condition for more than 30seconds.

(\*8) OVP circuit will shut the output down, manual reset (Re power on).

(\*9) Measured by the each measuring method of UL, CSA, EN and DENAN (at 60Hz), Ta=25°C.

(\*10) Ratings

- Derating at standard mounting. Refer to output derating curve(A240-01-02\_).

- Load (%) is percent of maximum output power or maximum output current, whichever is greater.

(\*11) Not include lead length on solder side.

(\*12) Inrush Current suppressors type. Limits vary according to ambient temperature and in case of re-entry.

(\*13) /FV option is for fixed output voltage.

# Outline Drawing

VS75E Standard Specification, /CO2, /FV

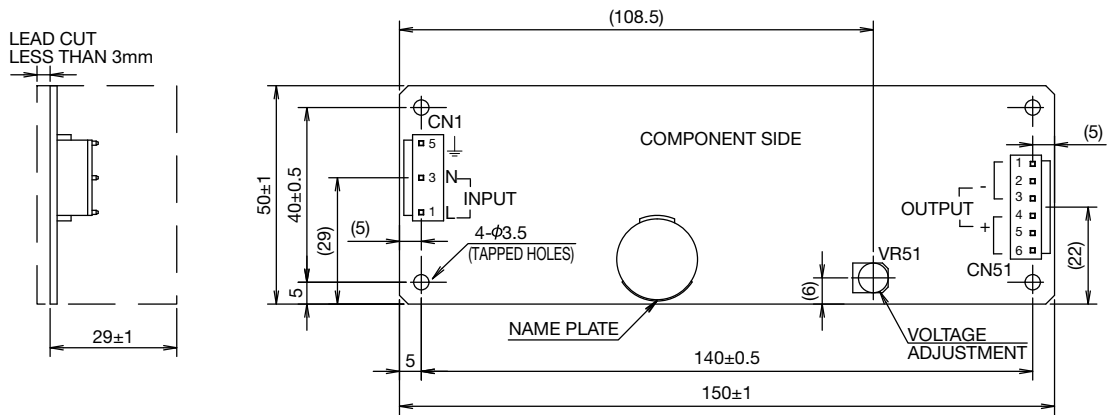

**CONNECTOR USED**

PART DESCRIPTION	PART NAME	MANUFACT	QTY
PIN HEADER (INPUT SIDE CN1)	B3P5-VH(LF)(SN)	J.S.T.	1
PIN HEADER (OUTPUT SIDE CN51)	B6P-VH(LF)(SN)	J.S.T.	1

\* OUTPUT CURRENT OF EACH CONNECTOR PIN MUST BE LESS THAN 5A.

**MATCHING HOUSINGS & PIN. (NOT INCLUDED WITH THE PRODUCT.)**

PART DESCRIPTION	PART NAME	MANUFACT	QTY
SOCKET HOUSING (CN1)	VHR-5N	J.S.T.	1
SOCKET HOUSING (CN51)	VHR-6N	J.S.T.	1
Terminal pin	SVH-21T-P1.1	J.S.T.	9
	BVH-21T-P1.1		
HAND CRIMPING TOOL	YC-160R	J.S.T.	-

**OPEN HARNESS**

	PART NAME
INPUT	HA-2-IN
OUTPUT	HA-4-OU

**VS75E/A**

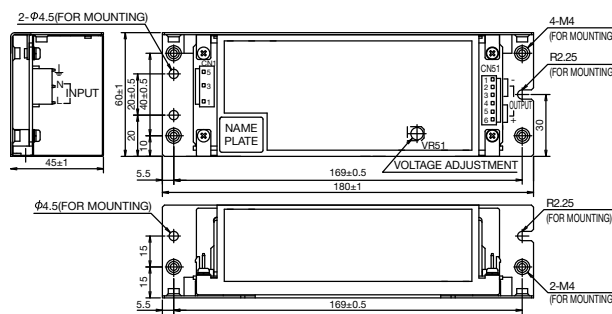

**VS75E/L**

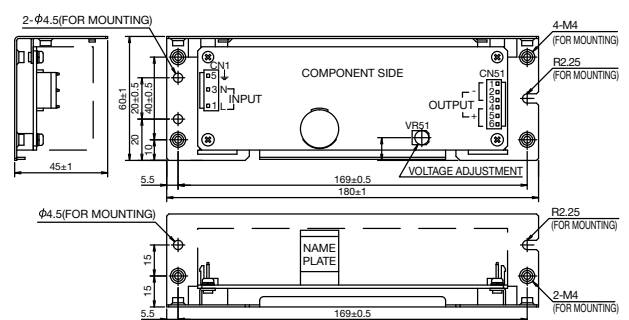

# Output Derating

VS75E Standard Specification, /CO2, /FV, /L

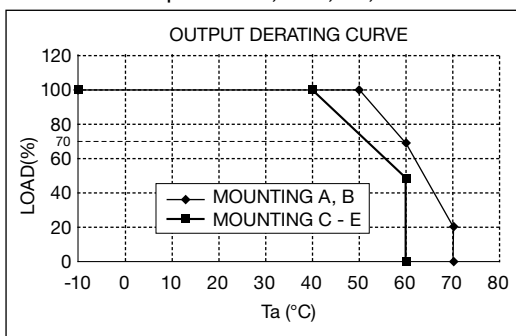

VS75E/A

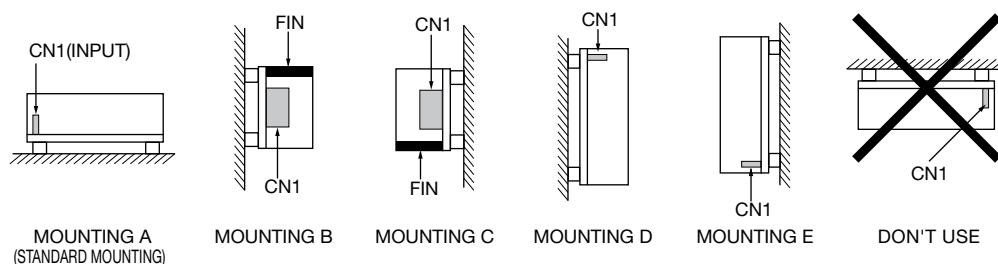
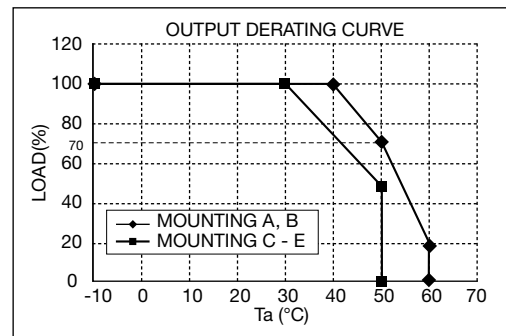

# VS100E Specifications

ITEMS/UNITS		MODEL	VS100E-3	VS100E-5	VS100E-12	VS100E-15	VS100E-24	VS100E-48	
Input	Voltage Range	(*2) V	AC 85 - 132 or DC 110 - 175						
	Frequency	(*2) Hz	47 - 63						
	Efficiency (Typ)	(*1) %	80	85			86	87	
	Current (Typ)	(*1) A	1.6	2.1					
	Inrush Current (Typ)	(*1)(*12) A	30A at Cold Start						
	Leakage Current	(*9) mA	Less than 0.5						
Output	Nominal Voltage	VDC	3.3	5	12	15	24	48	
	Maximum Current	A	20		8.5	7.0	4.3	2.2	
	Maximum Power	W	66.0	100.0	102.0	105.0	103.2	105.6	
	Maximum Line Regulation	(*3)(*5) mV	20		48	60	96	192	
	Maximum Load Regulation	(*3)(*6) mV	40		96	120	150	240	
	Temperature Coefficient	(*3)	Less than 0.02% / °C						
	Maximum Ripple & Noise(0≤Ta≤70°C)	(*3)(*4) mVp-p	120		150			200	
	Maximum Ripple & Noise(-10≤Ta<0°C)	(*3)(*4) mVp-p	160		180			240	
	Hold-up Time (Typ)	(*1) ms	20						
	Voltage Adjustable Range	(*13) VDC	2.97 - 3.63	4.5 - 5.5	10.8 - 13.2	13.5 - 16.5	21.6 - 26.4	43.2 - 52.8	
Function	Over Current Protection	(*7) A	21.0 -		8.92 -	7.35 -	4.51 -	2.31 -	
	Over Voltage Protection	(*8) VDC	3.80 - 4.46	5.75 - 6.75	13.8 - 16.2	17.3 - 20.3	27.6 - 32.4	55.2 - 64.8	
	Parallel Operation		-						
	Series Operation		Possible						
Environment	Operating Temperature	(*10) °C	Convection : -10 - +70 (-10 - +50:100%, +60:70%, +70:20%)						
	Storage Temperature	°C	-30 - +85						
	Operating Humidity	%RH	30 - 90 (No dewdrop)						
	Storage Humidity	%RH	10 - 95 (No dewdrop)						
	Vibration		At no operating, 10 - 55Hz (Sweep for 1min) 19.6m/s <sup>2</sup> Constant, X,Y,Z 1hour each.						
	Shock		Less than 196.1m/s <sup>2</sup>						
	Cooling		Convection Cooling						
Isolation	Withstand Voltage		Input - FG : 2kVAC (10mA), Input - Output : 2kVAC (10mA) Output - FG : 500VAC (20mA) for 1min						
	Isolation Resistance		More than 100MΩ at 25°C and 70%RH Output - FG : 500VDC						
Standards	Safety Standards		Approved by UL62368-1, CSA62368-1, EN62368-1, EN50178(OV II), UL60950-1, CSA60950-1, EN60950-1. (Expire date of 60950-1: 20/12/2020) Designed to meet Den-an Appendix 12 (J60950-1).						
	EMI		Designed to meet EN55011/EN55032-B, FCC-B, VCCI-B						
	Immunity		Designed to meet IEC61000-4-2(Level 2,3), -3(Level 3), -4(Level 3), -5(Level 2,3), -6(Level 3), -8(Level 4), -11						
Mechanical	Weight (Typ)	g	290						
	Size (W×H×D)	(*11) mm	62 x 29 x 155 ( Refer to Outline Drawing )						

\*Read instruction manual carefully, before using the power supply unit.

(\*1) At 100VAC, Ta=25°C, nominal output voltage and maximum output power.

(\*2) For cases where conformance to various safety specs (UL, CSA, EN) are required, to be described as 100 - 120VAC(50/60Hz).

(\*3) Please refer to Fig. A for measurement of line & load regulation and ripple voltage.

(\*4) For start up at low ambient temperature and low input voltage, output ripple noise might not meet specification.

However, there is no overshoot at start up and output ripple noise specification can be met after one second.

(\*5) 85 - 132VAC, constant load.

(\*6) No load-Full load, constant input voltage.

(\*7) 3.3, 5V model: Constant current limit and hiccup with automatic recovery.

12 - 48V model: Constant current limit with automatic recovery.

Avoid to operate at over load or short circuit condition for more than 30seconds.

(\*8) OVP circuit will shut the output down, manual reset (Re power on).

(\*9) Measured by the each measuring method of UL, CSA, EN and DENAN(at 60Hz), Ta=25°C.

(\*10) Ratings

- Derating at standard mounting. Refer to output derating curve(A241-01-02\_).

- Load (%) is percent of maximum output power or maximum output current, whichever is greater.

(\*11) Not include lead length on solder side.

(\*12) Inrush Current suppressors type. Limits vary according to ambient temperature and in case of re-entry.

(\*13) /FV option is for fixed output voltage.

# Outline Drawing

VS100E Standard Specification, /CO2, /FV

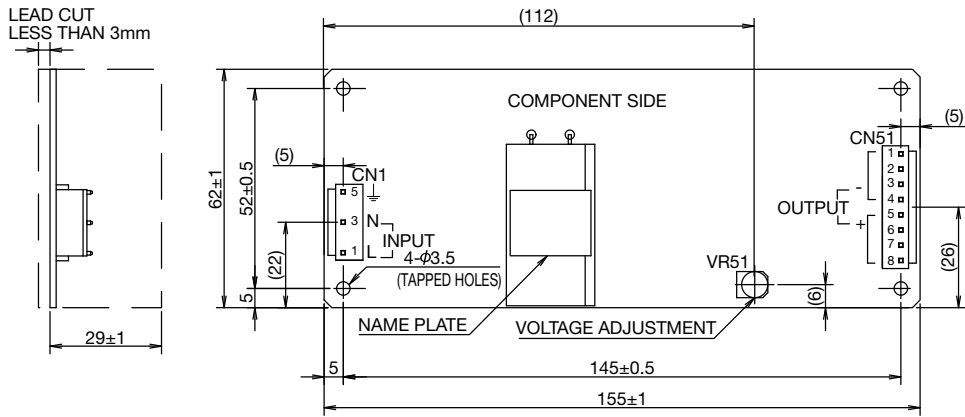

**CONNECTOR USED**

PART DESCRIPTION	PART NAME	MANUFACT	QTY
PIN HEADER (INPUT SIDE CN1)	B3P5-VH(LF)(SN)	J.S.T.	1
PIN HEADER (OUTPUT SIDE CN51)	B8P-VH(LF)(SN)	J.S.T.	1

\* OUTPUT CURRENT OF EACH CONNECTOR PIN MUST BE LESS THAN 5A.

**MATCHING HOUSINGS & PIN (NOT INCLUDED WITH THE PRODUCT.)**

PART DESCRIPTION	PART NAME	MANUFACT	QTY
SOCKET HOUSING (CN1)	VHR-5N	J.S.T.	1
SOCKET HOUSING (CN51)	VHR-8N	J.S.T.	1
Terminal pin	SVH-21T-P1.1	J.S.T.	11
	BVH-21T-P1.1		
HAND CRIMPING TOOL	YC-160R	J.S.T.	-

**OPEN HARNESS**

	PART NAME
INPUT	HA-2-IN
OUTPUT	HA-5-OU

**VS100E/A**

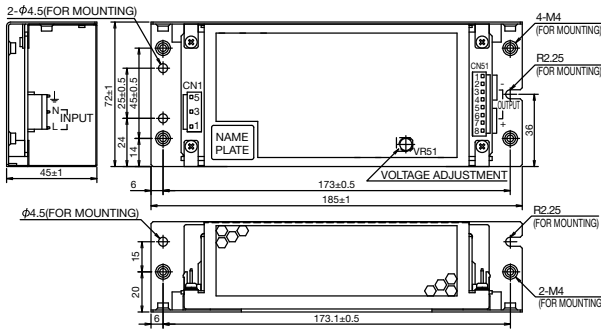

**VS100E/L**

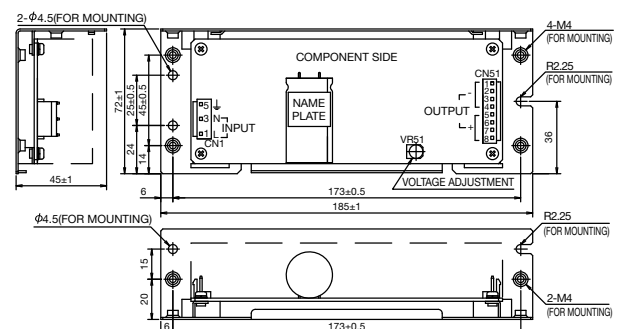

# Output Derating

VS100E Standard Specification, /CO2, /FV, /L

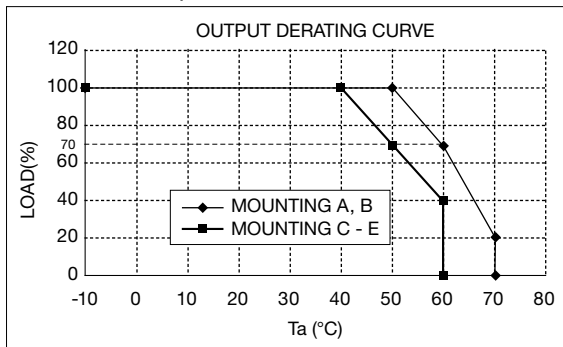

VS100E/A

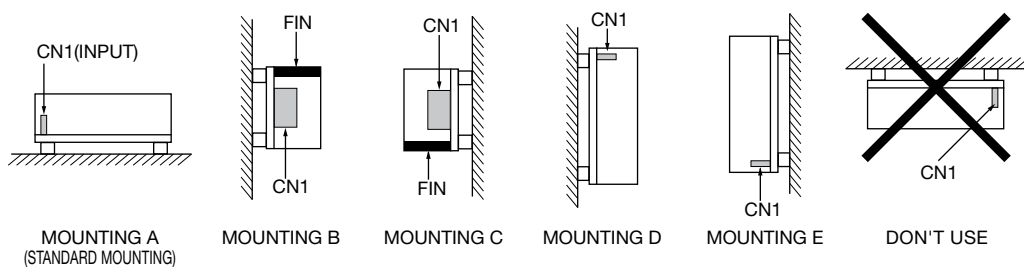
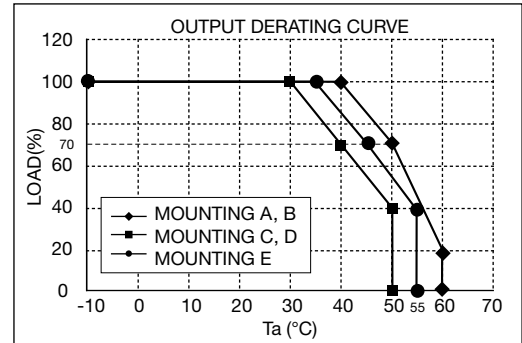

# VS150E Specifications

ITEMS/UNITS		MODEL	VS150E-3	VS150E-5	VS150E-12	VS150E-15	VS150E-24	VS150E-48
Input	Voltage Range	(*2) V	AC 85 - 132 or DC 110 - 175					
	Frequency	(*2) Hz	47 - 63					
	Efficiency (Typ)	(*1) %	80	86	87		88	
	Current (Typ)	(*1) A	2.4	3.2				
	Inrush Current (Typ)	(*1)(*12) A	30A at Cold Start					
	Leakage Current	(*9) mA	Less than 0.5					
Output	Nominal Voltage	VDC	3.3	5	12	15	24	48
	Maximum Current	A	30		12.5	10.0	6.3	3.2
	Maximum Power	W	99.0	150.0			151.2	153.6
	Maximum Line Regulation	(*3)(*5) mV	20		48	60	96	192
	Maximum Load Regulation	(*3)(*6) mV	40		96	120	150	240
	Temperature Coefficient	(*3)	Less than 0.02% / °C					
	Maximum Ripple & Noise(0≤Ta≤70°C)	(*3)(*4) mVp-p	120		150			200
	Maximum Ripple & Noise(-10≤Ta<0°C)	(*3)(*4) mVp-p	160		180			240
	Hold-up Time (Typ)	(*1) ms	20					
	Voltage Adjustable Range	(*13) VDC	2.97 - 3.63	4.5 - 5.5	10.8 - 13.2	13.5 - 16.5	21.6 - 26.4	43.2 - 52.8
Function	Over Current Protection	(*7) A	31.5 -		13.12 -	10.5 -	6.61 -	3.36 -
	Over Voltage Protection	(*8) VDC	3.80 - 4.46	5.75 - 6.75	13.8 - 16.2	17.3 - 20.3	27.6 - 32.4	55.2 - 64.8
	Parallel Operation		-					
	Series Operation		Possible					
Environment	Operating Temperature	(*10) °C	Convection : -10 - +70 (-10 - +50:100%, +60:70%, +70:20%)					
	Storage Temperature	°C	-30 - +85					
	Operating Humidity	%RH	30 - 90 (No dewdrop)					
	Storage Humidity	%RH	10 - 95 (No dewdrop)					
	Vibration		At no operating, 10 - 55Hz (Sweep for 1min) 19.6m/s <sup>2</sup> Constant, X,Y,Z 1hour each.					
	Shock		Less than 196.1m/s <sup>2</sup>					
	Cooling		Convection Cooling					
Isolation	Withstand Voltage		Input - FG : 2kVAC (10mA), Input - Output : 2kVAC (10mA) Output - FG : 500VAC (20mA) for 1min					
	Isolation Resistance		More than 100MΩ at 25°C and 70%RH Output - FG : 500VDC					
Standards	Safety Standards		Approved by UL62368-1, CSA62368-1, EN62368-1, EN50178(OV II), UL60950-1, CSA60950-1, EN60950-1. (Expire date of 60950-1: 20/12/2020) Designed to meet Den-an Appendix 12 (J60950-1).					
	EMI		Designed to meet EN55011/EN55032-B, FCC-B, VCCI-B					
	Immunity		Designed to meet IEC61000-4-2(Level 2,3), -3(Level 3), -4(Level 3), -5(Level 2,3), -6(Level 3), -8(Level 4), -11					
Mechanical	Weight (Typ)	g	390					
	Size (W×H×D)	(*11) mm	75 x 34 x 160 ( Refer to Outline Drawing )					

\*Read instruction manual carefully, before using the power supply unit.

(\*1) At 100VAC, Ta=25°C, nominal output voltage and maximum output power.

(\*2) For cases where conformance to various safety specs (UL, CSA, EN) are required, to be described as 100 - 120VAC(50/60Hz).

(\*3) Please refer to Fig. A for measurement of line & load regulation and ripple voltage.

(\*4) For start up at low ambient temperature and low input voltage, output ripple noise might not meet specification.

However, there is no overshoot at start up and output ripple noise specification can be met after one second.

(\*5) 85 - 132VAC, constant load.

(\*6) No load-Full load, constant input voltage.

(\*7) 3.3, 5V model: Constant current limit and hiccup with automatic recovery.

12 - 48V model: Constant current limit with automatic recovery.

Avoid to operate at over load or short circuit condition for more than 30seconds.

(\*8) OVP circuit will shut the output down, manual reset (Re power on).

(\*9) Measured by the each measuring method of UL, CSA, EN and DENAN(at 60Hz), Ta=25°C.

(\*10) Ratings

- Derating at standard mounting. Refer to output derating curve(A242-01-02\_).

- Load (%) is percent of maximum output power or maximum output current, whichever is greater.

(\*11) Not include lead length on solder side.

(\*12) Inrush Current suppressors type. Limits vary according to ambient temperature and in case of re-entry.

(\*13) /FV option is for fixed output voltage.



# Outline Drawing

## VS1150E Standard Specification, /CO2, /FV

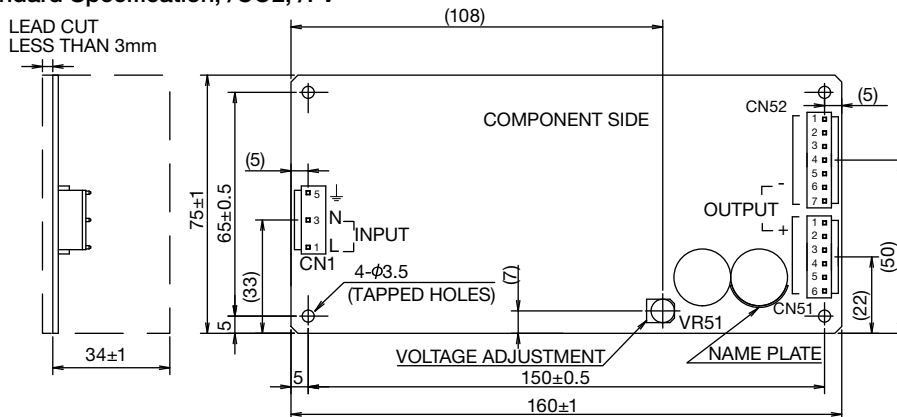

### CONNECTOR USED

PART DESCRIPTION	PART NAME	MANUFACT	QTY
PIN HEADER (INPUT SIDE CN1)	B3P5-VH(LF)(SN)	J.S.T.	1
PIN HEADER (OUTPUT SIDE CN51)	B6P-VH(LF)(SN)	J.S.T.	1
PIN HEADER (OUTPUT SIDE CN52)	B7P-VH(LF)(SN)	J.S.T.	1

\* OUTPUT CURRENT OF EACH CONNECTOR PIN MUST BE LESS THAN 5A.

### MATCHING HOUSINGS & PIN. (NOT INCLUDED WITH THE PRODUCT.)

PART DESCRIPTION	PART NAME	MANUFACT	QTY
SOCKET HOUSING (CN1)	VHR-5N	J.S.T.	1
SOCKET HOUSING (CN51)	VHR-6N	J.S.T.	1
SOCKET HOUSING (CN52)	VHR-7N	J.S.T.	1
Terminal pin	SVH-21T-P1.1	J.S.T.	11
	BVH-21T-P1.1		
HAND CRIMPING TOOL	YC-160R	J.S.T.	-

### OPEN HARNESS

	PART NAME
INPUT	HA-2-IN
OUTPUT	+ : HA-6-OU
	- : HA-7-OU

### VS150E/A

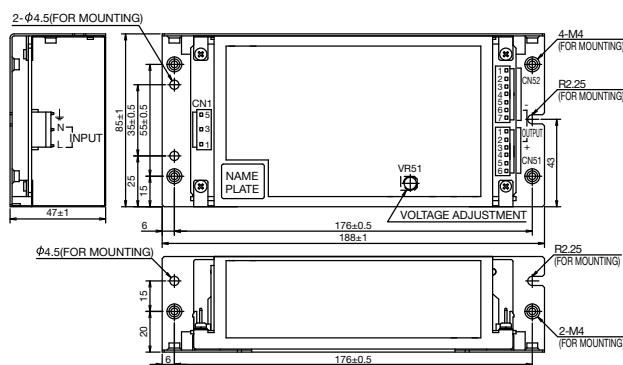

### VS150E/L

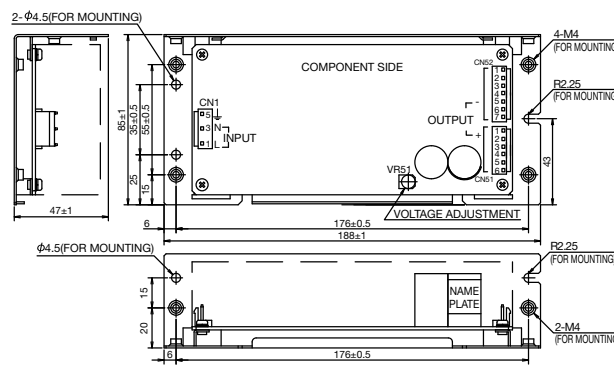

# Output Derating

## VS150E Standard Specification, /CO2, /FV, /L

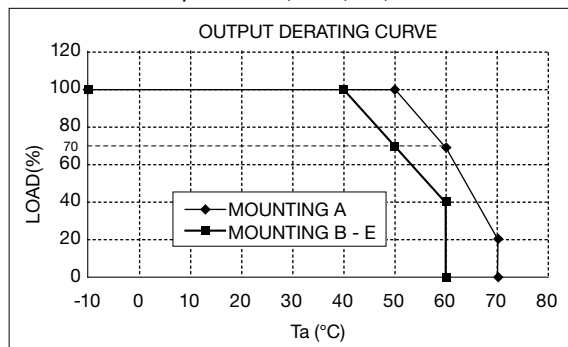

## VS150E/A

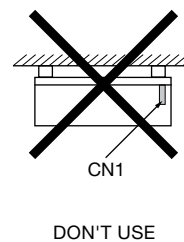
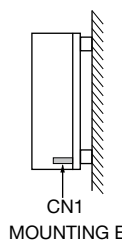
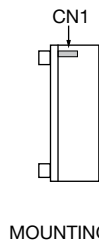
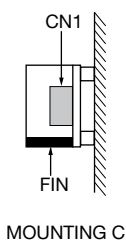
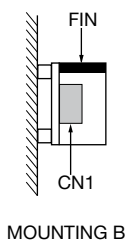
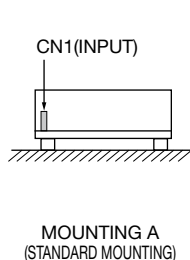
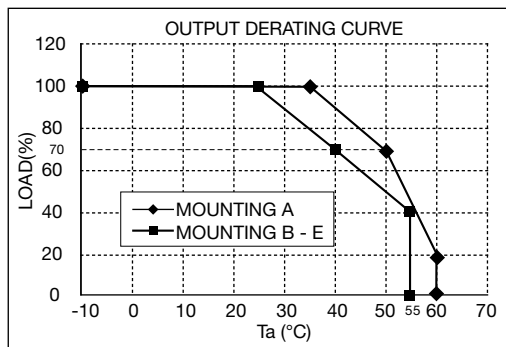

## **VS-E Series Instruction Manual**

Be sure to read this instruction manual thoroughly before using this product. Pay attention to all cautions and warnings before using this product.

VS-E Series Instruction Manual [https://product.tdk.com/info/en/documents/instruction\\_manual/vs-e\\_apl.pdf](https://product.tdk.com/info/en/documents/instruction_manual/vs-e_apl.pdf)

## X-ON Electronics

Largest Supplier of Electrical and Electronic Components

*Click to view similar products for [Switching Power Supplies](#) category:*

*Click to view products by [TDK-Lambda](#) manufacturer:*

Other Similar products are found below :

[70841011](#) [73-551-0005](#) [73-551-0048](#) [PS3E-B12F](#) [PS3E-E12F](#) [AAD600S-4-OP](#) [R22095](#) [KD0204](#) [9021](#) [LDIN100150](#) [LPM000-BBAR-01](#)  
[LPX17S-C](#) [EVS57-10R6/R](#) [FP80](#) [FRV7000G](#) [22929](#) [PS3E-F12F](#) [CQM1IA121](#) [40370121900](#) [VI-PU22-EXX](#) [40370121910](#) [LDIN5075](#)  
[LPM615-CHAS](#) [LPX140-C](#) [09-160CFG](#) [70841025](#) [VPX3000-CBL-DC](#) [VI-LUL-IU](#) [LPM000-BBAR-05](#) [LPM000-BBAR-08](#) [LPM124-](#)  
[OUTA1-48](#) [LPM000-BBAR-07](#) [LPM109-OUTA1-10](#) [LPM616-CHAS](#) [08-30466-1055G](#) [08-30466-2175G](#) [08-30466-2125G](#) [DMB-EWG](#)  
[TVQF-1219-18S](#) [6504-226-2101](#) [CQM1IPS01](#) [SP-300-5](#) [CQM1-IPS02](#) [VI-MUL-ES](#) [22829](#) [08-30466-0065G](#) [VI-RU031-EWWX](#) [08-30466-](#)  
[0028G](#) [EP3000AC48INZ](#) [VP-C2104853](#)