

General Description

The TD1509 is a series of easy to use fixed and adjustable step-down (buck) switch-mode voltage regulators. These devices are available in fixed output voltage of 5V,3.3V an adjustable output version. Both versions are capable of driving a 2A load with excellent line and load regulation.

Requiring a minimum number of external components, these regulators are simple to use and include internal frequency compensation, and a fixed-frequency oscillator.

The output voltage is guaranteed to $\pm 3\%$ tolerance under specified input voltage and output load conditions. The oscillator frequency is guaranteed to $\pm 15\%$. External shutdown is included, featuring typically 80 μA standby current. Self protection features include a two stage frequency reducing current limit for the output switch and an over temperature shutdown for complete protection under fault conditions.

The TD1509 is available in SOP8 and DIP8 packages.

Package Types

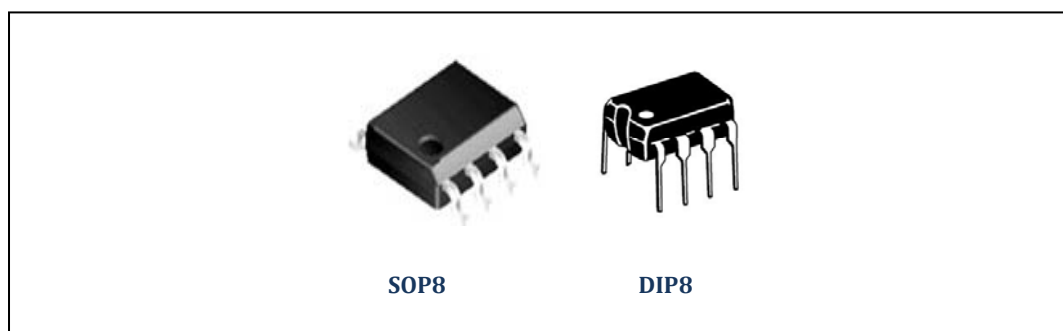

Figure 1. Package Types of TD1509

Features

- 5V,3.3V and adjustable output versions
- Output adjustable from 1.23v to 43V
- Fixed 150KHz frequency internal oscillator
- Guaranteed 3A output load current
- Input voltage range up to 45V
- Low power standby mode, I_Q typically 80 μA
- TTL shutdown capability
- Excellent line and load regulation
- Requires only 4 external components
- High efficiency
- Thermal shutdown and current limit protection
- Available in SOP8 and DIP8 packages

Applications

- Simple High-efficiency step-down regulator
- On-card switching regulators
- Positive to negative converter
- LCD monitor and LCD TV
- DVD recorder and PDP TV
- Battery charger
- Step-down to 3.3V for microprocessors

Pin Configurations

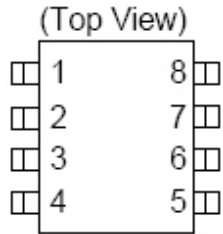

DIP8/SOP8

Figure 2 Pin Configuration of TD1509 (Top View)

Pin Description

Pin Number	Pin Name	Description
1	Vin	Input supply voltage
2	Output	Switching output
5~8	GND	Ground
3	FB	Output voltage feedback
4	ON/OFF	ON/OFF shutdown Active is "Low" or floating

Ordering Information

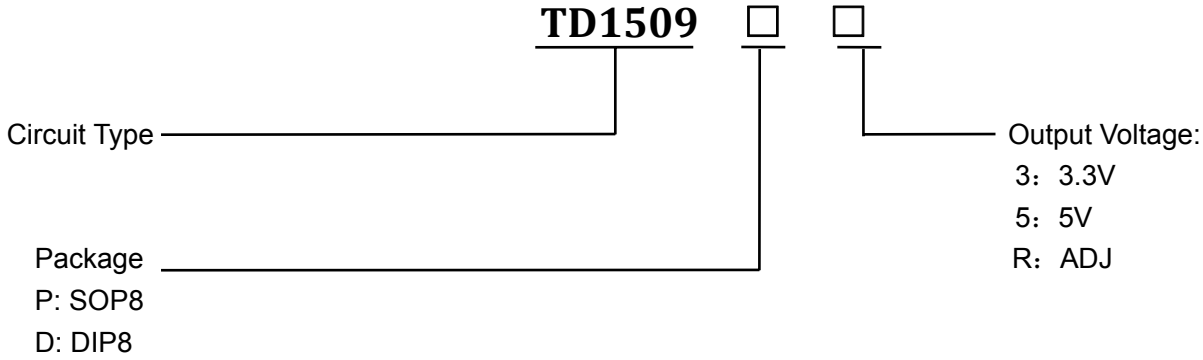

Function Block

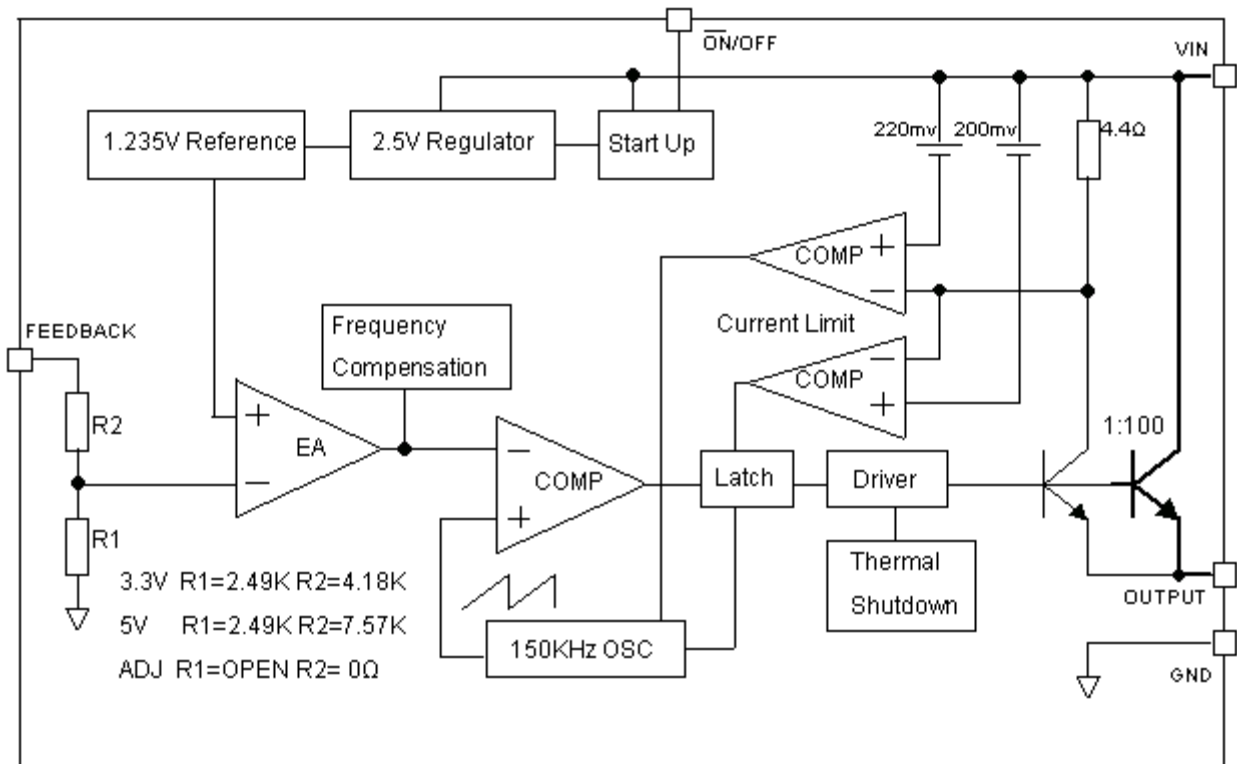

Figure 3 Function Block Diagram of TD1509

Absolute Maximum Ratings

Note1: Stresses greater than those listed under Maximum Ratings may cause permanent damage to the device. This is a stress rating only and functional operation of the device at these or any other conditions above those indicated in the operation is not implied. Exposure to absolute maximum rating conditions for extended periods may affect reliability.

Parameter	Symbol	Value	Unit
Input Voltage	V_{IN}	-0.3 to 45	V
Feedback Pin Voltage	V_{FB}	-0.3 to $V_{in}+0.3$	V
ON/OFF Pin Voltage	V_{EN}	-0.3 to $V_{in}+0.3$	V
Output Pin Voltage	V_{SW}	-0.3 to $V_{in}+0.3$	V
Power Dissipation	P_D	Internally limited	mW
Operating Junction Temperature	T_J	150	°C
Storage Temperature	T_{STG}	-65 to 150	°C
Lead Temperature (Soldering, 10 sec)	T_{LEAD}	260	°C
ESD (HBM)		2000	V
MSL		Level3	
Thermal Resistance-Junction to Ambient	$R_{\theta JA}$	85	°C / W
Thermal Resistance-Junction to Case	$R_{\theta JC}$	45	°C / W

Recommended Operating Conditions

Parameter	Symbol	Min.	Max.	Unit
Input Voltage	V_{IN}	3.6	45	V
Operating Junction Temperature	T_J	-40	125	°C
Operating Ambient Temperature	T_A	-40	85	°C

Electrical Characteristics

Specifications with **boldface type** are for full operating temperature range, the other type are for $T_j=25^{\circ}\text{C}$.

Note1: Thermal resistance with copper area of approximately 3 in².

Parameters	Symbol	Test Condition	Min.	Typ.	Max.	Unit
Feedback bias current	I_b	Adjustable only, $V_{FB}=1.3\text{V}$		10	50/100	nA
Quiescent current	I_Q	$V_{FB}=12\text{V}$ force driver off		5	10	mA
Standby quiescent current	I_{STBY}	ON/OFF=5V, $V_{IN}=36\text{V}$		80	200/250	uA
Oscillator frequency	F_{OSC}		127	150	173	KHz
Saturation voltage	V_{SAT}	$I_{OUT}=3\text{A}$		1.2	1.4/1.5	V
Current Limit	I_{CL}	Peak Current ($V_{FB}=0\text{V}$)		3.8	4.2	A
Output leakage current	I_L I_L	Output=0V ($V_{FB}=12\text{V}$)			50	uA
Output leakage current		Output=-1V ($V_{IN}=36\text{V}$)		2	30	mA
ON/OFF pin logic input Threshold voltage	V_{IL} V_{IH}	Low (Regulator ON)		1.3	0.6	V
ON/OFF pin input current	I_H I_L	High (Regulator OFF)	2.0	1.3		V
		$V_{LOGIC}=2.5\text{V}$ (Regulator OFF)		5	15	uA
		$V_{LOGIC}=0.5\text{V}$ (Regulator ON)		0.02	5	uA
Thermal Resistance Junction to Case	θ_{JC}			45		$^{\circ}\text{C/W}$
Thermal Resistance Junction to Ambient (Note1)	θ_{JA}			85		$^{\circ}\text{C/W}$

Electrical Characteristics(Cont.)

Specifications with **boldface type** are for full operating temperature range, the other type are for $T_j=25^{\circ}\text{C}$.

Note1: Thermal resistance with copper area of approximately 3 in².

Parameters	Symbol	Test Condition	Min.	Typ.	Max.	Unit
TD1509 ADJ	Vout: Output Voltage	$11\text{V} \leq V_{\text{IN}} \leq 45\text{V}$, $0.2\text{A} \leq I_{\text{LOAD}} \leq 3\text{A}$, V_{OUT} for 9V	1.193/ 1.180	1.23	1.267/ 1.280	V
	η : Efficiency	$V_{\text{IN}}=12\text{V}$, $V_{\text{OUT}}=9\text{V}$, $I_{\text{LOAD}}=3\text{A}$		88		%
TD1509 5V	Vout: Output Voltage	$7\text{V} \leq V_{\text{IN}} \leq 45\text{V}$, $0.2\text{A} \leq I_{\text{LOAD}} \leq 3\text{A}$	4.800/ 4.750	5.0	5.200/ 5.250	V
	η : Efficiency	$V_{\text{IN}}=12\text{V}$, $I_{\text{LOAD}}=3\text{A}$		83		%
TD1509 3.3V	Vout: Output Voltage	$4.75\text{V} \leq V_{\text{IN}} \leq 45\text{V}$, $0.2\text{A} \leq I_{\text{LOAD}} \leq 2\text{A}$	3.168/ 3.135	3.3	3.432/ 3.465	V
	η : Efficiency	$V_{\text{IN}}=12\text{V}$, $I_{\text{LOAD}}=2\text{A}$		76		%

Typical Performance Characteristics

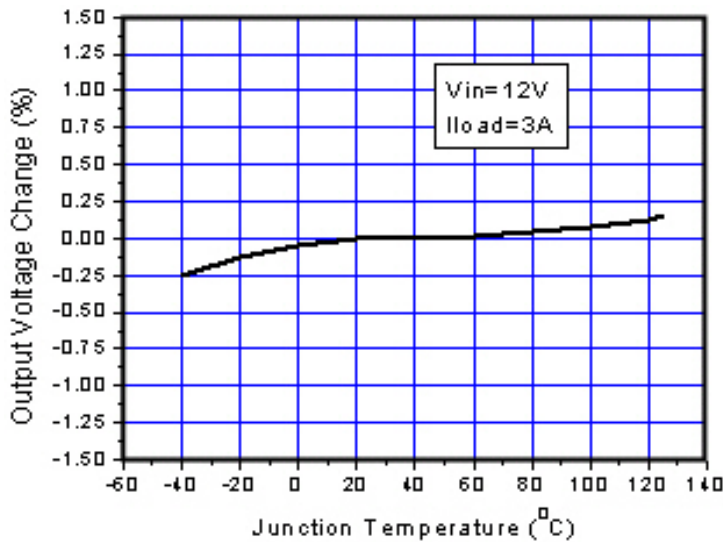

Figure 4. Output Voltage vs. Temperature

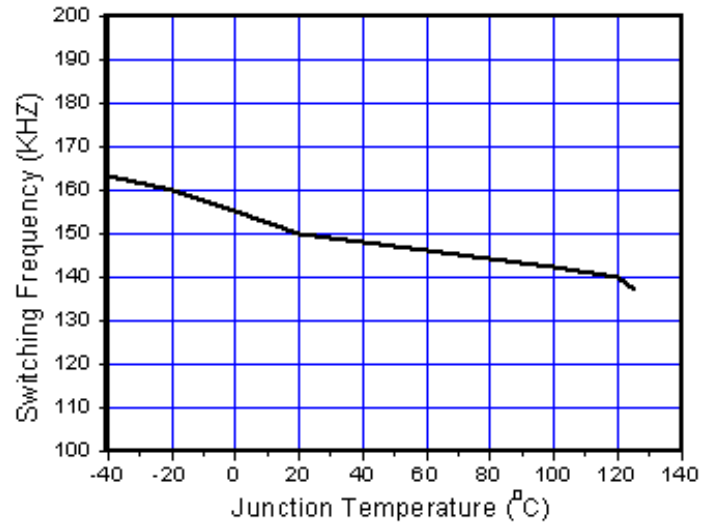

Figure 5. Switching Frequency vs. Temperature

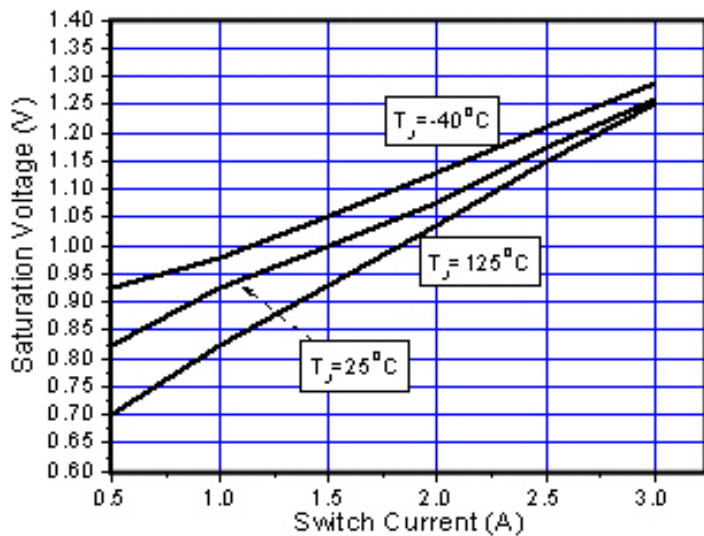

Figure 6. Output Saturation Characteristics

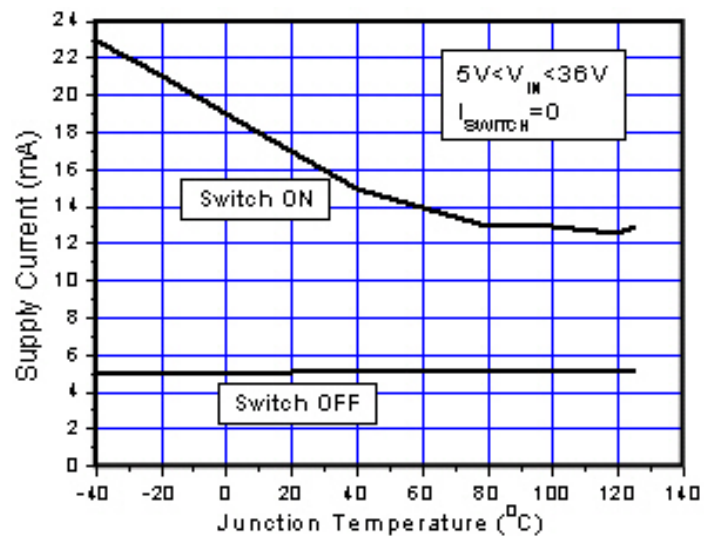

Figure 7. Quiescent Current vs. Temperature

Typical Performance Characteristics(Cont.)

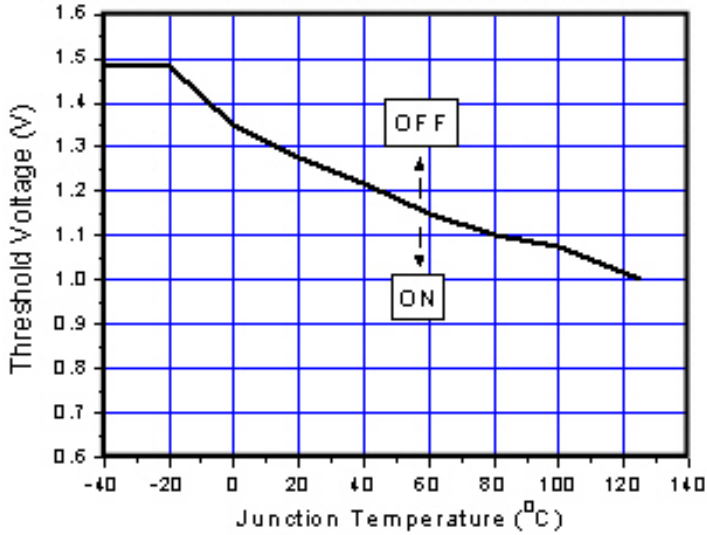

Figure 8. ON/OFF Pin Voltage

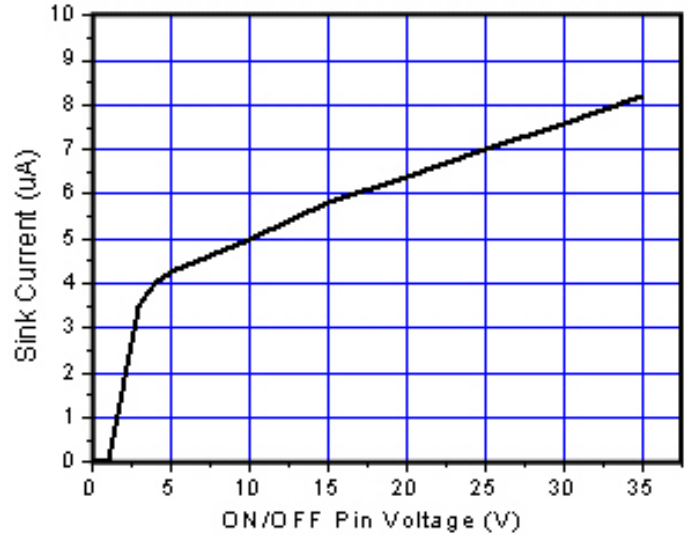

Figure 9. ON/OFF Pin Sink Current

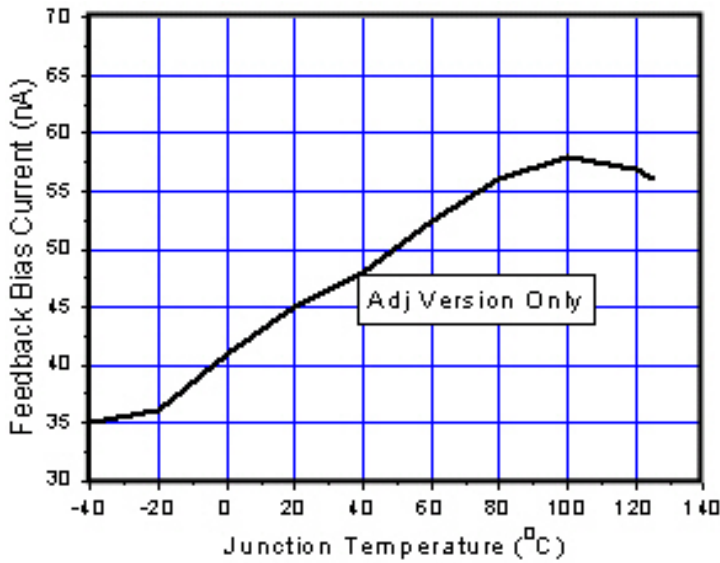

Figure 10. Output Saturation Characteristics

Typical Application Circuit

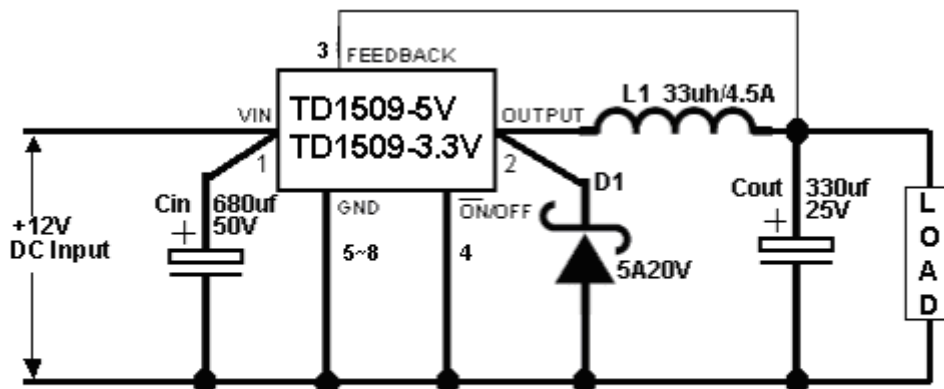

Figure 11. Typical Application of TD1509 For 3.3V 5V

Input Voltage	Inductor (L1)	Output Capacitor (Cout)	
		Through Hole Electrolytic	Surface Mount Tantalum
6V ~ 18V	47uh	470uf/25V	330uf/6.3V
6V ~ 45V	68uh	560uf/25V	330uf/6.3V

Table 1. TD1509 Series Buck Regulator Design Procedure For 3.3V

Input Voltage	Inductor (L1)	Output Capacitor (Cout)	
		Through Hole Electrolytic	Surface Mount Tantalum
8V ~ 18V	33uh	330uf/25V	220uf/10V
8V ~ 45V	47uh	470uf/25V	330uf/10V

Table 2. TD1509 Series Buck Regulator Design Procedure For 5V

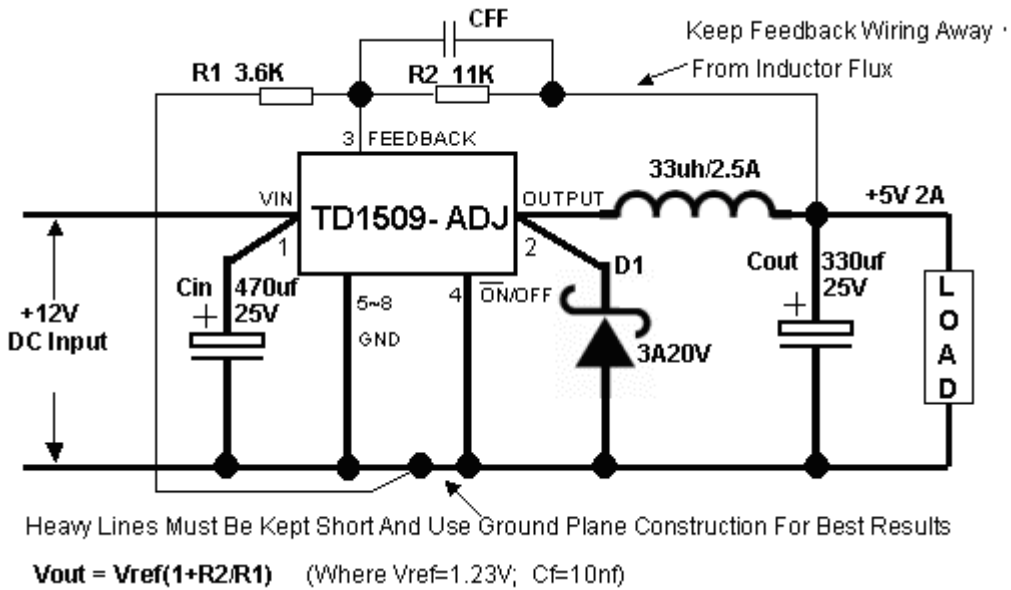

Figure 12. Typical Application of TD1509 For ADJ

Note:In PCB layout. Reserved an area for CFF

Vout	R1	R2	Cf (Operational)
3.3V	1.6K	2.7K	33nf
5V	3.6K	11K	10nf
9V	6.8K	43K	1.5nf
12V	1.5K	13K	1nf

Table 3. Vout VS. R1, R2, Cf Select Table

Output Voltage	Input Voltage	Inductor (L1)	Output Capacitor (Cout)
			Through Hole Electrolytic
3.3V	6V ~ 18V	47uh	470uf/25V
	6V ~ 36V	68uh	560uf/25V
5V	8V ~ 18V	33uh	330uf/25V
	8V ~ 36V	47uh	470uf/25V
9V	12V ~ 18V	47uh	330uf/25V
	12V ~ 36V	47uh	470uf/25V
12V	15V ~ 18V	47uh	220uf/25V
	15V ~ 36V	47uh	330uf/25V

Table 4. Typical Application Buck Regulator Design Procedure

Function Description

Pin Functions

+V_{IN}

This is the positive input supply for the IC switching regulator. A suitable input bypass capacitor must be present at this pin to minimize voltage transients and to supply the switching currents needed by the regulator

Ground

Circuit ground.

Output

Internal switch. The voltage at this pin switches between (+V_{IN} – V_{SAT}) and approximately – 0.5V, with a duty cycle of approximately V_{OUT} / V_{IN}. To minimize coupling to sensitive circuitry, the PC board copper area connected to this pin should be kept a minimum.

Feedback

Senses the regulated output voltage to complete the feedback loop.

ON/OFF

Allows the switching regulator circuit to be shutdown using logic level signals thus dropping the total input supply current to approximately 80uA. Pulling this pin below a threshold voltage of approximately 1.3V turns the regulator on, and pulling this pin above 1.3V (up to a maximum of 25V) shuts the regulator down. If this shutdown feature is not needed, the ON /OFF pin can be wired to the ground pin or it can be left open, in either case the regulator will be in the ON condition.

Thermal Considerations

The TD1509 is available in two packages,.

The TD1509 junction temperature rises above ambient temperature for a 2A load and different input and output voltages. The data for these curves was taken with the TD1509 operating as a buck switching regulator in an ambient temperature of 25°C (still air). These temperature rise numbers are all approximate and there are many factors that can affect these temperatures. Higher ambient temperatures require more heat sinking. The SOP8/DIP8 surface mount package tab is designed to be soldered to the copper on a printed circuit board. The copper and the board are the heat sink for this package and the other heat producing components, such as the catch diode and inductor. The PC board copper area that the package is soldered to should be at least 0.4 in², and ideally should have 2 or more square inches of 2 oz. Additional copper area improves the thermal characteristics, but with copper areas greater than approximately 6 in², only small improvements in heat dissipation are realized. If further thermal improvements are needed, double sided, multilayer PC board with large copper areas and/or airflow are recommended.

The TD1509 junction temperature rise above ambient temperature with a 2A load for various input and output voltages. This data was taken with the circuit operating as a buck switching regulator with all components mounted on a PC board to simulate the junction temperature under actual operating conditions. This curve can be used for a quick check for the approximate junction temperature for various conditions, but be aware that there are many factors that can affect the junction temperature. When load currents higher than 2A are used, double sided or multilayer PC boards with large copper areas and/or airflow might be needed, especially for high ambient temperatures and high output voltages. For the best thermal performance, wide copper traces and generous amounts of printed circuit board copper should be used in the board layout. (Once exception to

Function Description(Cont.)

this is the output (switch) pin, which should not have large areas of copper.) Large areas of copper provide the best transfer of heat (lower thermal resistance) to the surrounding air, and moving air lowers the thermal resistance even further.

Setting the Output Voltage

The output voltage is set using a resistive voltage divider from the output voltage to FB(TD1509-ADJ) The voltage divider divides the output voltage down by the ratio:

$$V_{FB} = V_{OUT} * R1 / (R1 + R2)$$

Thus the output voltage is:

$$V_{OUT} = 1.235 * (R1 + R2) / R1$$

R1 can be as high as 100KΩ, but a typical value is 10KΩ.

Using that value, R2 is determined by:

$$R2 \approx 8.18 * (V_{OUT} - 1.235) (K\Omega)$$

For example, for a 3.3V output voltage, R1 is 10KΩ, and R2 is 17KΩ.

Inductor

The inductor is required to supply constant current to the output load while being driven by the switched input voltage. A larger value inductor results in less ripple current that in turn results in lower output ripple voltage. However, the larger value inductor has a larger physical size, higher series resistance, and/or lower saturation current. Choose an inductor that does not saturate under the worst-case load conditions. A good rule for determining the inductance is to allow the peak-to-peak ripple current in the inductor to be approximately 30% of the maximum load current. Also, make sure that the peak inductor current (the load current plus half the peak to peak inductor ripple current) is below the TBDA minimum current limit. The inductance value can be calculated by the equation:

$$L = (V_{OUT}) * (V_{IN} - V_{OUT}) / V_{IN} * f * \Delta I$$

Where V_{OUT} is the output voltage, V_{IN} is the input voltage, f is the switching frequency, and ΔI is the peak-to-peak inductor ripple current.

Input Capacitor

The input current to the step-down converter is discontinuous, and so a capacitor is required to supply the AC current to the step-down converter while maintaining the DC input voltage. A low ESR capacitor is required to keep the noise at the IC to a minimum.

Ceramic capacitors are preferred, but tantalum or low-ESR electrolytic capacitors may also suffice.

The input capacitor value should be greater than 10μF.

The capacitor can be electrolytic, tantalum or ceramic.

However since it absorbs the input switching current it requires an adequate ripple current rating. Its RMS current rating should be greater than approximately 1/2 of the DC load current.

For insuring stable operation should be placed as close to the IC as possible. Alternately a smaller high quality ceramic 0.1μF capacitor may be placed closer to the IC and a larger capacitor placed further away. If using this technique, it is recommended that the larger capacitor be a tantalum or electrolytic type. All ceramic capacitors should be placed close to the TD1509.

Output Capacitor

The output capacitor is required to maintain the DC output voltage. Low ESR capacitors are preferred to keep the output voltage ripple low. The characteristics of the output capacitor also affect the stability of the regulation control system. Ceramic, tantalum, or low ESR electrolytic capacitors are recommended. In the case of ceramic capacitors, the impedance at the switching frequency is dominated by the capacitance,

Function Description(Cont.)

and so the output voltage ripple is mostly independent of the ESR. The output voltage ripple is estimated to be:

$$\text{VRIPPLE} \sim 1.4 * \text{VIN} * (\text{fLC}/\text{fSW})^2$$

Where VRIPPLE is the output ripple voltage, VIN is the input voltage, fLC is the resonant frequency of the LC filter, fSW is the switching frequency. In the case of tantalum or low-ESR electrolytic capacitors, the ESR dominates the impedance at the switching frequency, and so the output ripple is calculated as:

$$\text{VRIPPLE} \sim \Delta I * \text{RESR}$$

Where VRIPPLE is the output voltage ripple, ΔI is the inductor ripple current, and RESR is the equivalent series resistance of the output capacitors.

Output Rectifier Diode

The output rectifier diode supplies the current to the inductor when the high-side switch is off. To reduce losses due to the diode forward voltage and recovery times, use a Schottky rectifier.

Table 1 provides the Schottky rectifier part numbers based on the maximum input voltage and current rating. Choose a rectifier whose maximum reverse voltage rating is greater than the maximum input voltage, and whose current rating is greater than the maximum load current.

Feedforward Capacitor (CFF)

For output voltages greater than approximately 8V, an additional capacitor is required. The compensation capacitor is typically between 100 pF and 33 nF, and is wired in parallel with the output voltage setting resistor, R2. It provides additional stability for high output voltages, low input-output voltages, and/or very low ESR

output capacitors, such as solid tantalum capacitors.

$$C_{FF} = \frac{1}{31 \times 10^3 \times R_2}$$

This capacitor type can be ceramic, plastic, silver mica, etc. (Because of the unstable characteristics of ceramic capacitors made with Z5U material, they are not recommended.)

Note: In PCB layout, reserved an area for CFF.

Over Current Protection (OCP)

The cycle by cycle current limit threshold is set between 3.8A and 4A. When the load current reaches the current limit threshold, the cycle by cycle current limit circuit turns off the high side switch immediately to terminate the current duty cycle. The inductor current stops rising. The cycle by cycle current limit protection directly limits inductor peak current. The average inductor current is also limited due to the limitation on peak inductor current. When the cycle by cycle current limit circuit is triggered, the output voltage drops as the duty cycle is decreasing.

Thermal Management and Layout

Consideration

In the TD1509 buck regulator circuit, high pulsing current flows through two circuit loops. The first loop starts from the input capacitors, to the VIN pin, to the VOUT pins, to the filter inductor, to the output capacitor and load, and then returns to the input capacitor through ground.

Current flows in the first loop when the high side switch is on. The second loop starts from the inductor, to the output capacitors and load, to the GND pin of the TD1509, and to the VOUT pins of the TD1509. Current flows in the second loop when the low side diode is on.

In PCB layout, minimizing the two loops area reduces the

Function Description(Cont.)

noise of this circuit and improves efficiency. A ground plane is recommended to connect input capacitor, output capacitor, and GND pin of the TD1509.

In the TD1509 buck regulator circuit, the two major power dissipating components are the TD1509 and output inductor. The total power dissipation of converter circuit can be measured by input power minus output power.

$$P_{total_loss} = V_{IN} \times I_{IN} - V_O \times I_O$$

The power dissipation of inductor can be approximately calculated by output current and DCR of inductor.

$$P_{inductor_loss} = I_O^2 \times R_{inductor} \times 1.1$$

The junction to ambient temperature can be got from power dissipation in the TD1509 and thermal impedance from junction to ambient.

$$T_{(jun-amb)} = (P_{totalloss} - P_{inductorloss}) \times \Theta_{JA}$$

The maximum junction temperature of TD1509 is 145°C, which limits the maximum load current capability. Please see the thermal de-rating curves for the maximum load current of the TD1509 under different ambient temperatures.

The thermal performance of the TD1509 is strongly affected by the PCB layout. Extra care should be taken by users during the design process to ensure that the IC will operate under the recommended environmental conditions.

Several layout tips are listed below for the best electric and thermal performance.

1. Do not use thermal relief connection to the VIN and the GND pin. Pour a maximized copper area to the GND pin and the VIN pin to help thermal dissipation.
2. Input capacitor should be connected to the VIN pin and the GND pin as close as possible.
3. Make the current trace from VOUT pins to L to the GND as short as possible.
4. Pour copper plane on all unused board area and connect it to stable DC nodes, like VIN, GND, or VOUT.
5. Keep sensitive signal traces such as trace connecting FB pin away from the VOUT pins.

Package Information

SOP8 Package Outline Dimensions

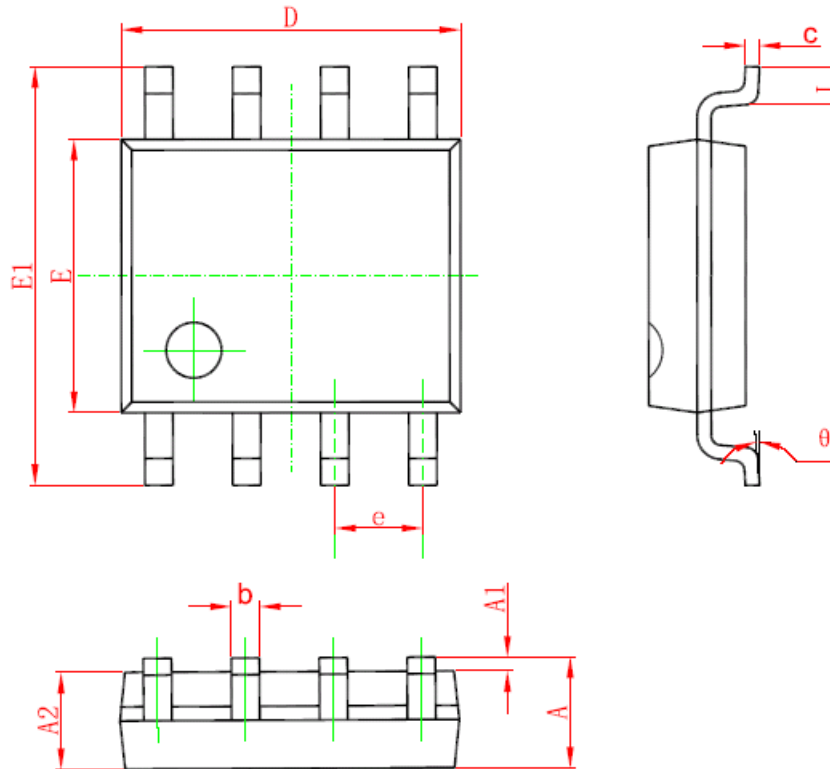

Symbol	Dimensions In Millimeters		Dimensions In Inches	
	Min	Max	Min	Max
A	1.350	1.750	0.053	0.069
A1	0.100	0.250	0.004	0.010
A2	1.350	1.550	0.053	0.061
b	0.330	0.510	0.013	0.020
c	0.170	0.250	0.006	0.010
D	4.700	5.100	0.185	0.200
E	3.800	4.000	0.150	0.157
E1	5.800	6.200	0.228	0.244
e	1.270 (BSC)		0.050 (BSC)	
L	0.400	1.270	0.016	0.050
θ	0°	8°	0°	8°

Package Information(Cont.)

DIP8 Package Outline Dimensions

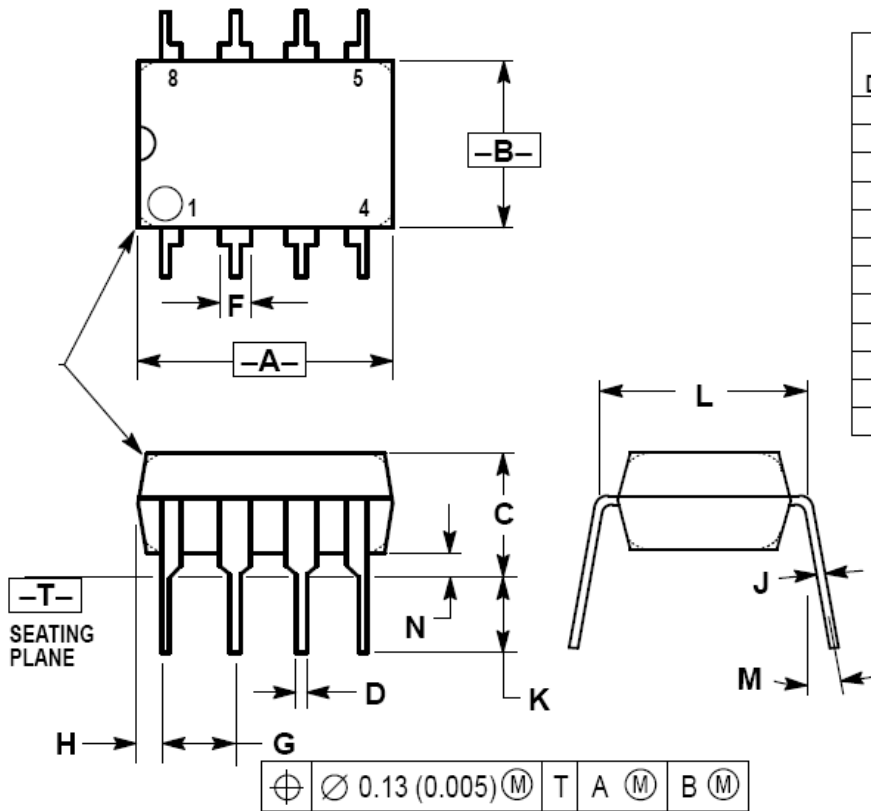

DIM	MILLIMETERS		INCHES	
	MIN	MAX	MIN	MAX
A	9.40	10.16	0.370	0.400
B	6.10	6.60	0.240	0.260
C	3.94	4.45	0.155	0.175
D	0.38	0.51	0.015	0.020
F	1.02	1.78	0.040	0.070
G	2.54 BSC		0.100 BSC	
H	0.76	1.27	0.030	0.050
J	0.20	0.30	0.008	0.012
K	2.92	3.43	0.115	0.135
L	7.62 BSC		0.300 BSC	
M	—	10°	—	10°
N	0.76	1.01	0.030	0.040

⊕	∅ 0.13 (0.005) (M)	T	A (M)	B (M)
---	--------------------	---	-------	-------

Design Notes

X-ON Electronics

Largest Supplier of Electrical and Electronic Components

Click to view similar products for [Switching Controllers](#) category:

Click to view products by [Techcode](#) manufacturer:

Other Similar products are found below :

[NCP1218AD65R2G](#) [NCP1244BD065R2G](#) [NCP1336ADR2G](#) [NCP6153MNTWG](#) [NCP81101BMNTXG](#) [NCP81205MNTXG](#) [SJE6600](#)
[AZ7500BMTR-E1](#) [SG3845DM](#) [NCP1250BP65G](#) [NCP4204MNTXG](#) [NCP6132AMNR2G](#) [NCP81102MNTXG](#) [NCP81206MNTXG](#)
[NCP1240AD065R2G](#) [NCP1240FD065R2G](#) [NCP1361BABAYSNT1G](#) [NCP1230P100G](#) [NX2124CSTR](#) [SG2845M](#) [NCP1366BABAYDR2G](#)
[NCP81101MNTXG](#) [NCP81174NMNTXG](#) [NCP4308DMTTWG](#) [NCP4308AMTTWG](#) [NCP1366AABAYDR2G](#) [NCP1251FSN65T1G](#)
[NCP1246BLD065R2G](#) [MB39A136PFT-G-BND-ERE1](#) [NCP1256BSN100T1G](#) [LV5768V-A-TLM-E](#) [NCP1365BABCYDR2G](#)
[NCP1365AABCYDR2G](#) [NCP1246ALD065R2G](#) [AZ494AP-E1](#) [CR1510-10](#) [NCP4205MNTXG](#) [XRP6141ELTR-F](#) [RY8017](#) [LP6260SQVF](#)
[LP6298QVF](#) [ISL6121LIB](#) [ISL6225CA](#) [ISL6244HRZ](#) [ISL6268CAZ](#) [ISL6315IRZ](#) [ISL6420AIAZ-TK](#) [ISL6420AIRZ](#) [ISL6420IAZ](#)
[ISL6421ERZ](#)