

DESCRIPTION

The TDM3428B uses advanced trench technology to provide excellent RDS(ON) and low gate charge. This device is suitable for use as a load switch or in PWM applications.

GENERAL FEATURES

- RDS(ON) < 17.5mΩ @ VGS=4.5V
RDS(ON) < 10.8mΩ @ VGS=10V
- High Power and current handling capability
- Lead free product is available
- Surface Mount Package

Application

- PWM applications
- Load switch
- Power management

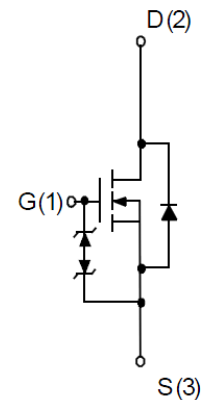

N-Channel MOSFET

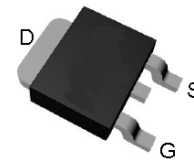

Top View of TO-252-3

ABSOLUTE MAXIMUM RATINGS(T_A=25°C unless otherwise noted)

Parameter	Symbol	Limit	Unit
Drain-Source Voltage	V _{DS}	30	V
Gate-Source Voltage	V _{GS}	±20	V
Diode Continuous Forward Current	I _S (T _C =25°C)	5	A
Continuous Drain Current (Note 1)	I _D (T _C =25°C)	45	A
	I _D (T _C =100°C)	30	A
Pulse Drain Current Tested	I _{DM} (T _A =25°C)	36	A
Maximum Power Dissipation	P _D (T _C =25°C)	40	W
	P _D (T _C =100°C)	16	W
Maximum Power Dissipation	P _D (T _A =25°C)	3.5	W
	P _D (T _A =70°C)	2.2	W
Thermal Resistance,Junction-to-Case	R _{θJC}	2.8	°C/W
Thermal Resistance,Junction-to-Ambient(t<10s)	R _{θJA}	50	°C/W
Maximum Operating Junction Temperature	T _J	150	°C
Storage Temperature Range	T _{STG}	-55 To 150	°C

NOTES:

1. Max continuous current is limited by bonding wire.

ELECTRICAL CHARACTERISTICS ($T_A=25^\circ\text{C}$ unless otherwise noted)

Parameter	Symbol	Condition	Min	Typ	Max	Unit
OFF CHARACTERISTICS						
Drain-Source Breakdown Voltage	BV_{DSS}	$V_{GS}=0V, I_D=250\mu A$	30	-	-	V
Zero Gate Voltage Drain Current	I_{DSS}	$V_{DS}=24V, V_{GS}=0V$	-	-	1	μA
Gate-Body Leakage Current	I_{GSS}	$V_{GS}=\pm 20V, V_{DS}=0V$	-	-	± 10	μA
ON CHARACTERISTICS (Note 2)						
Gate Threshold Voltage	$V_{GS(th)}$	$V_{DS}=V_{GS}, I_D=250\mu A$	1.4	1.8	2.5	V
Drain-Source On-State Resistance	$R_{DS(on)}$	$V_{GS}=10V, I_D=10A$	-	9.7	10.8	$m\Omega$
		$V_{GS}=4.5V, I_D=8A$	-	13.5	17.5	$m\Omega$
DYNAMIC CHARACTERISTICS (Note 3)						
Input Capacitance	C_{iss}	$V_{DS}=15V, V_{GS}=0V, F=1.0MHz$	-	450	600	PF
Output Capacitance	C_{oss}		-	318	-	PF
Reverse Transfer Capacitance	C_{rss}		-	22	-	PF
SWITCHING CHARACTERISTICS (Note 3)						
Turn-on Delay Time	$t_{d(on)}$	$V_{DS}=15V, R_L=15\Omega, V_{GEN}=10V, R_G=6\Omega, I_D=1A$	-	8.5	16	nS
Turn-on Rise Time	t_r		-	10	18	nS
Turn-Off Delay Time	$t_{d(off)}$		-	14	26	nS
Turn-Off Fall Time	t_f		-	10.6	19	nS
Total Gate Charge	Q_g	$V_{DS}=15V, I_D=10A, V_{GS}=10V$	-	8	12	nC
Gate-Source Charge	Q_{gs}		-	1.6	-	nC
Gate-Drain Charge	Q_{gd}		-	1.2	-	nC
Body Diode Reverse Recovery Time	T_{rr}	$I_{DS}=10A, di/dt=100A/\mu s$	-	20.5	-	nS
Body Diode Reverse Recovery Charge	Q_{rr}		-	7.2	-	nC
DRAIN-SOURCE DIODE CHARACTERISTICS						
Diode Forward Voltage (Note 2)	V_{SD}	$V_{GS}=0V, I_S=5A$	-	0.8	1.1	V

NOTES:

- Pulse Test: Pulse Width $\leq 300\mu s$, Duty Cycle $\leq 2\%$.
- Guaranteed by design, not subject to production testing

Typical Operating Characteristics

Power Dissipation

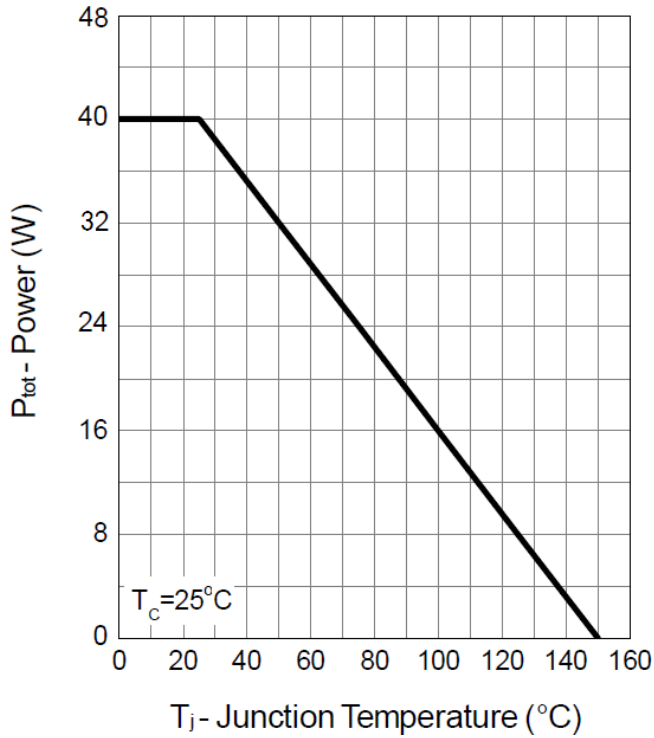

Drain Current

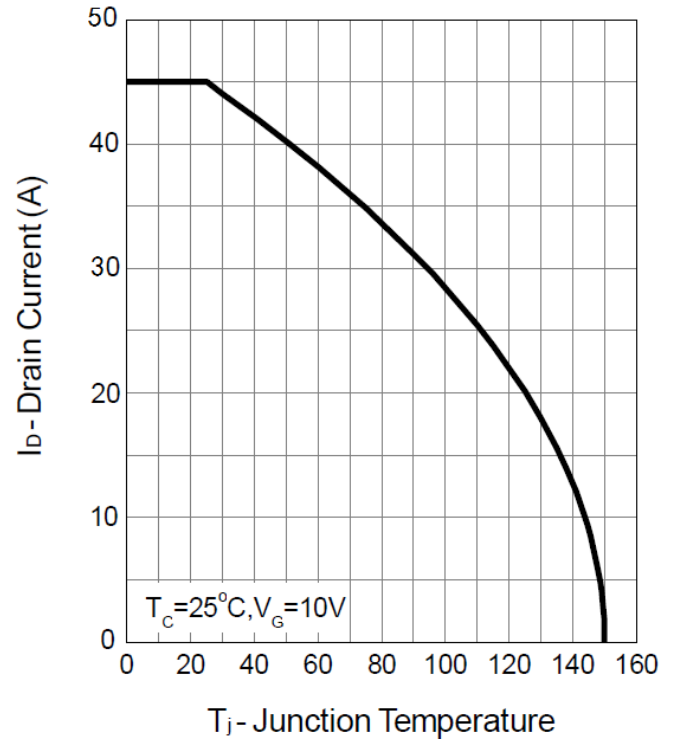

Safe Operation Area

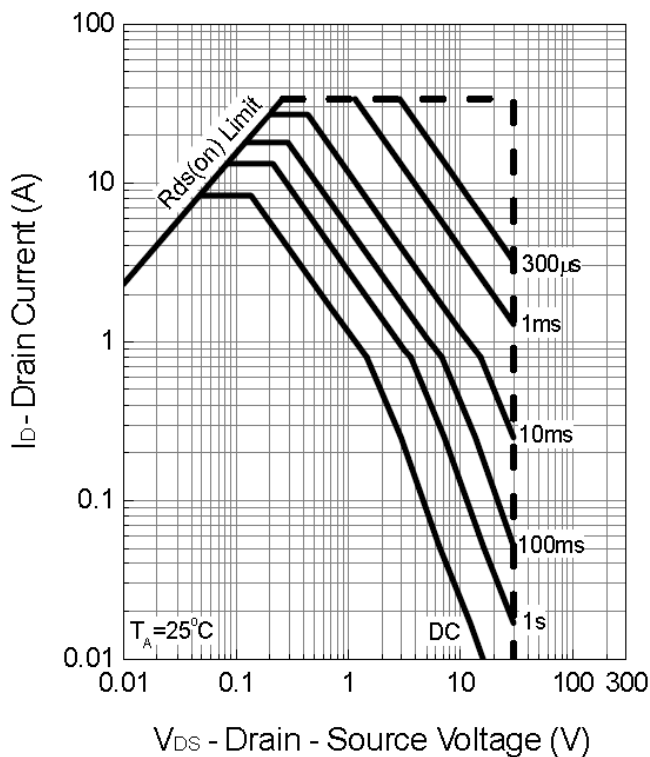

Thermal Transient Impedance

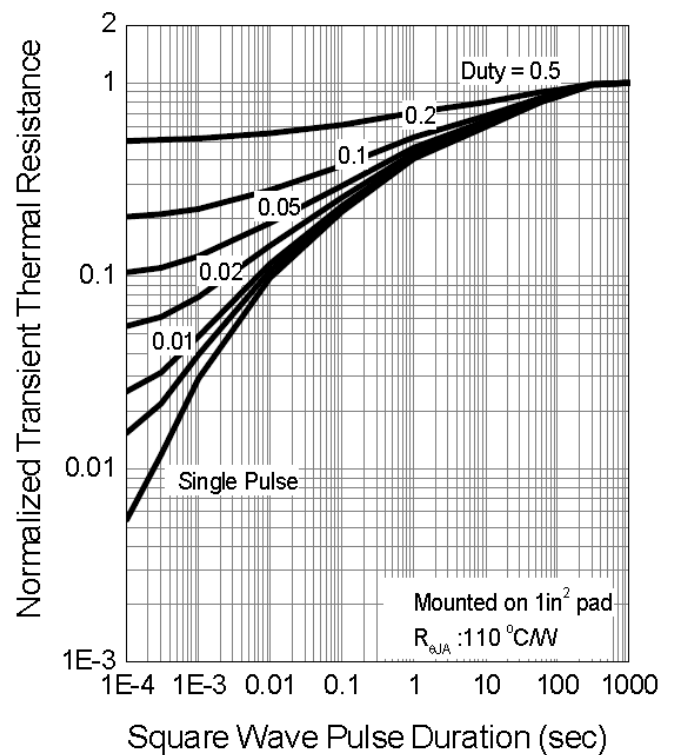

Typical Operating Characteristics(Cont.)

Output Characteristics

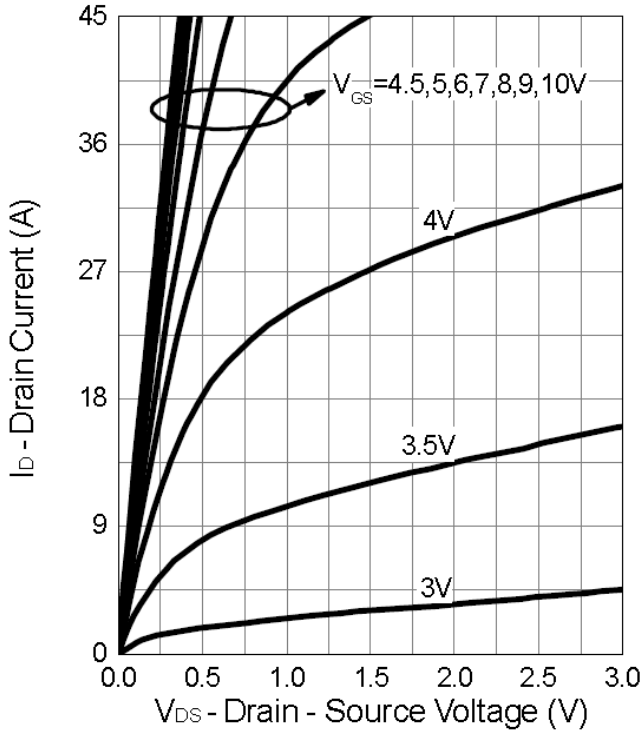

Drain-Source On Resistance

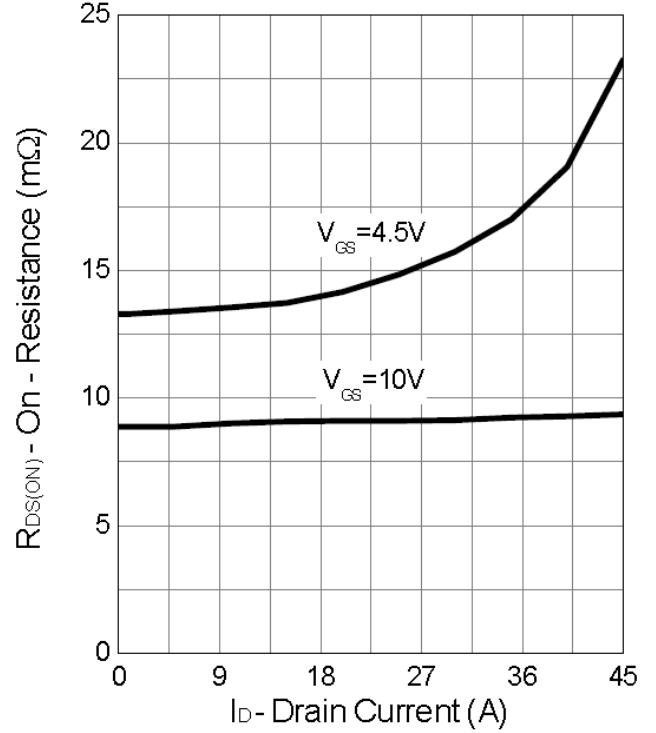

Gate-Source On Resistance

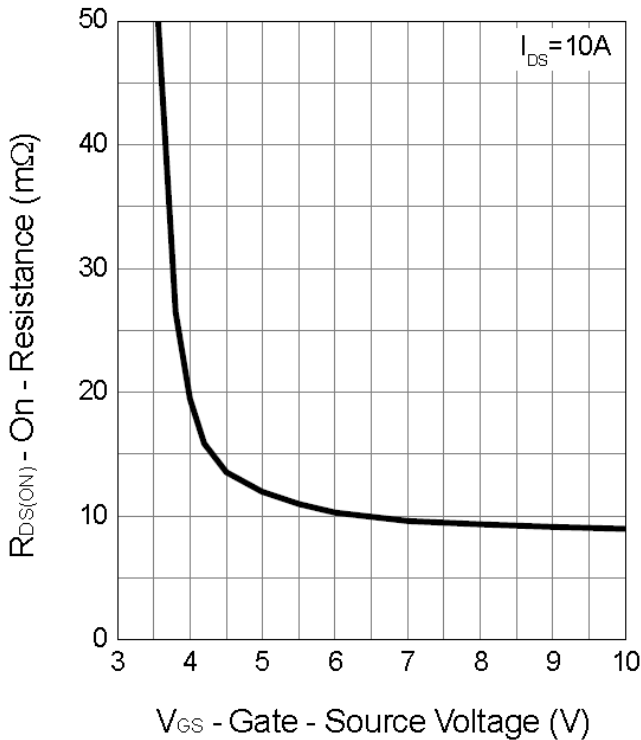

Gate Threshold Voltage

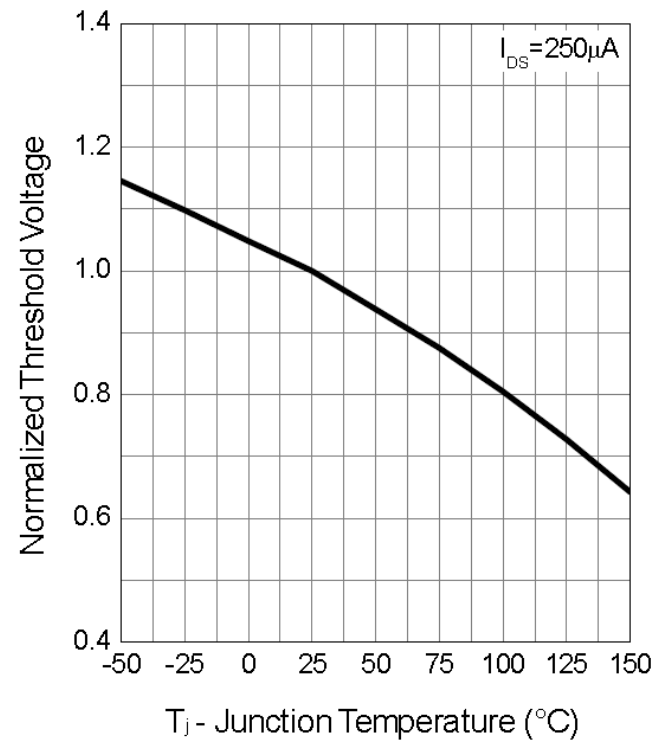

Typical Operating Characteristics (Cont.)

Drain-Source On Resistance

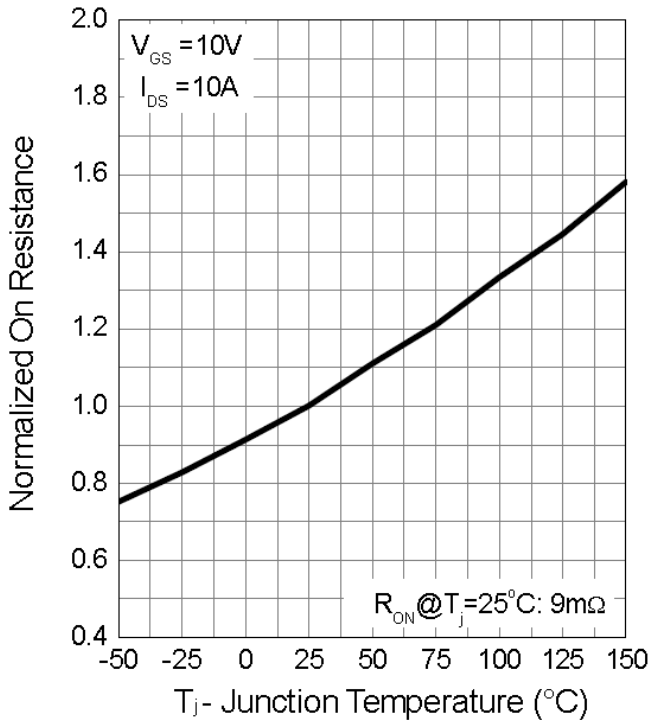

Source-Drain Diode Forward

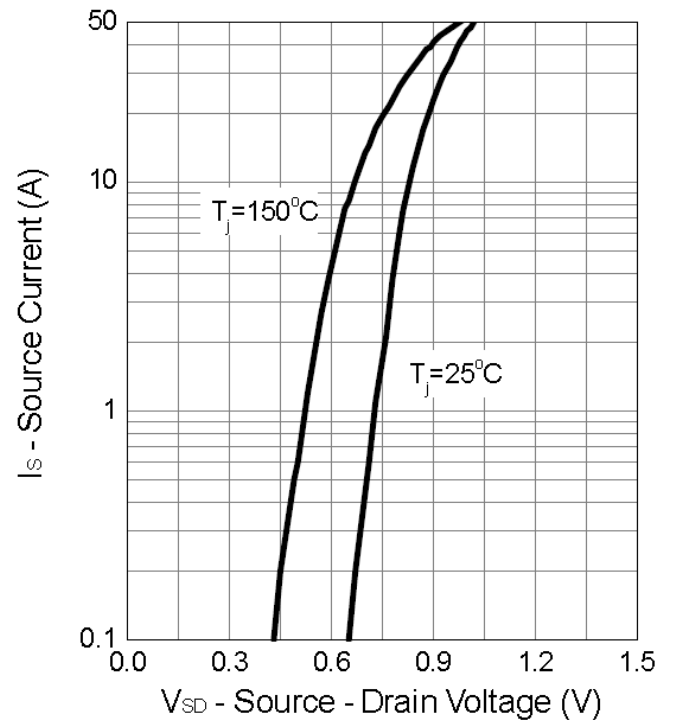

Capacitance

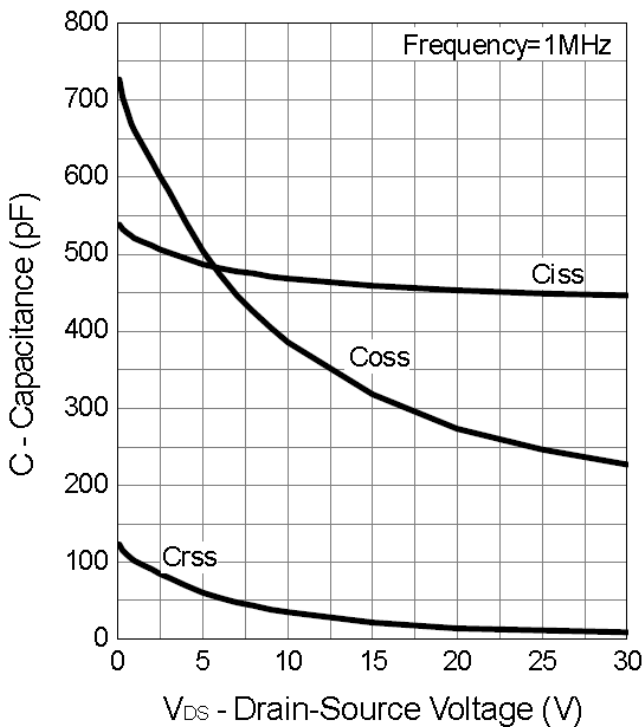

Gate Charge

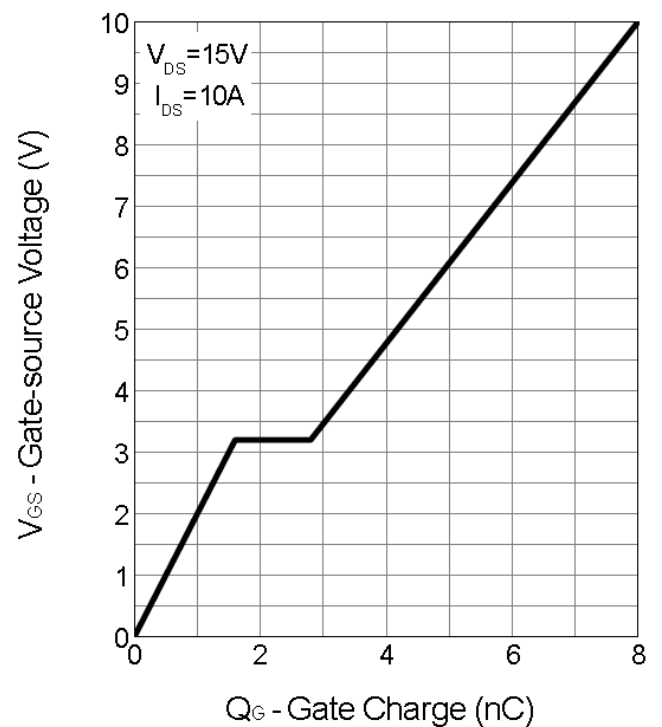

Package Information

TO252-3 Package

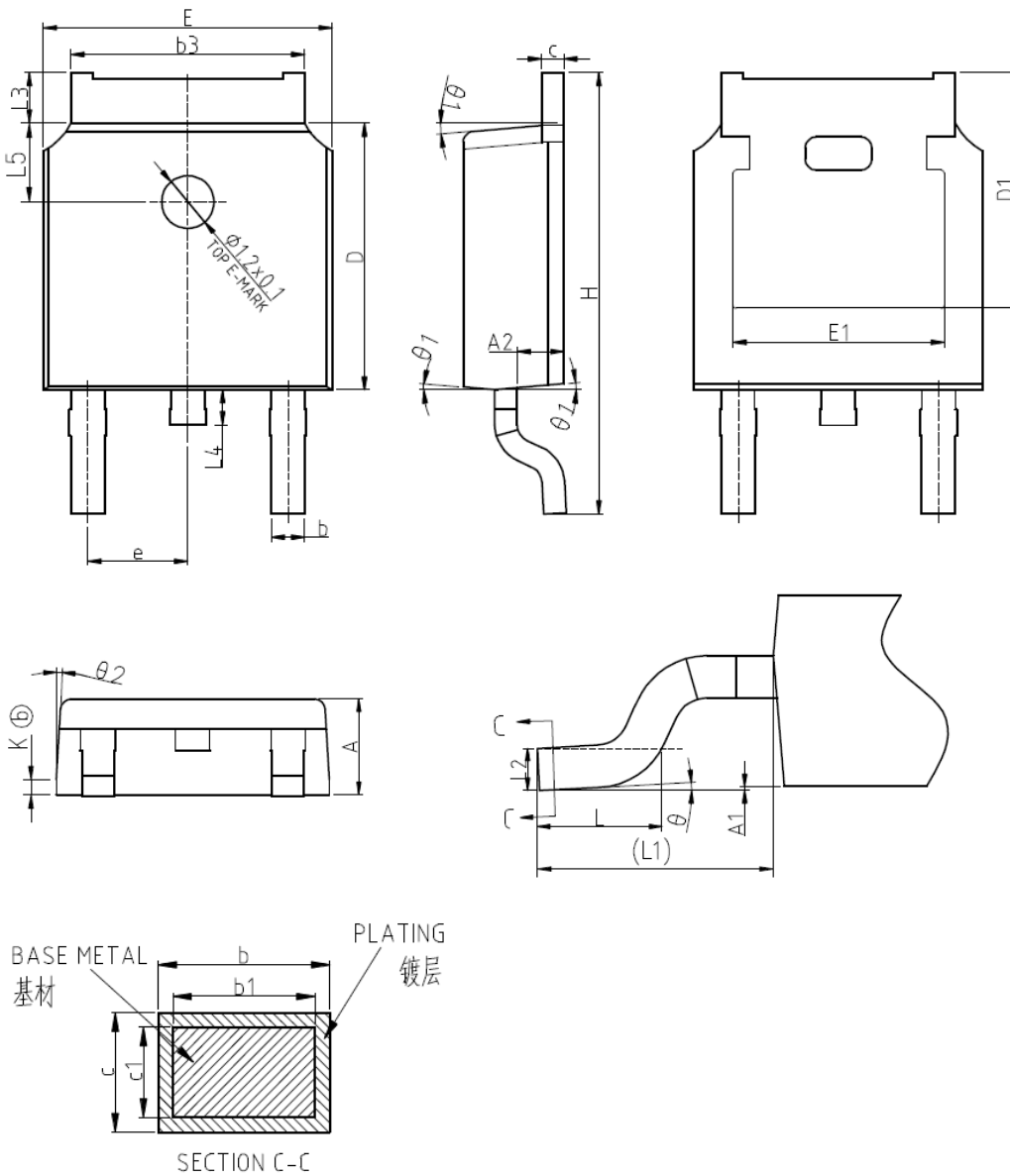

SYMBOL	mm		
	MIN	NOM	MAX
A	2.20	2.30	2.40
A1	0.00	-	0.20
A2	0.97	1.07	1.17
b	0.68	0.78	0.90
b1	0.66	0.76	0.88
b3	5.20	5.33	5.50
c	0.43	0.53	0.63
c1	0.41	0.51	0.61
D	5.98	6.10	6.22
D1	5.30REF		
E	6.40	6.60	6.80
E1	4.63	4.83	5.03
e	2.286BSC		
H	9.40	10.10	10.50
L	1.38	1.50	1.75
L1	2.90REF		
L2	0.51BSC		
L3	0.88	-	1.28
L4	-	-	1.00
L5	1.65	1.80	1.95
θ	0°	-	8°
θ1	5°	7°	9°
θ2	5°	7°	9°
K	0.40REF		

Design Notes

X-ON Electronics

Largest Supplier of Electrical and Electronic Components

Click to view similar products for [MOSFET](#) category:

Click to view products by [Techcode](#) manufacturer:

Other Similar products are found below :

[614233C](#) [648584F](#) [NTNS3A92PZT5G](#) [IRFD120](#) [IRFF430](#) [JANTX2N5237](#) [2N7000](#) [2SK2464-TL-E](#) [FCA20N60_F109](#) [FDZ595PZ](#) [AOD464](#)
[2SK2267\(Q\)](#) [2SK2545\(Q,T\)](#) [405094E](#) [423220D](#) [MIC4420CM-TR](#) [VN1206L](#) [614234A](#) [715780A](#) [SSM6J414TU,LF\(T](#) [751625C](#)
[IPP60R600P6XKSA1](#) [RJK60S5DPK-M0#T0](#) [PSMN4R2-30MLD](#) [TK31J60W5,S1VQ\(O](#) [2SK2614\(TE16L1,Q\)](#) [DMN1017UCP3-7](#)
[EFC2J004NUZTDG](#) [FCAB21350L1](#) [P85W28HP2F-7071](#) [DMN1053UCP4-7](#) [NTE2384](#) [NTE2969](#) [NTE6400A](#) [DMN61D9UWQ-13](#)
[US6M2GTR](#) [DMN31D5UDJ-7](#) [SSM6P54TU,LF](#) [DMP22D4UFO-7B](#) [IPS60R3K4CEAKMA1](#) [DMN1006UCA6-7](#) [DMN16M9UCA6-7](#)
[STF5N65M6](#) [STU5N65M6](#) [C3M0021120D](#) [DMN13M9UCA6-7](#) [BSS340NWH6327XTSA1](#) [MCM3400A-TP](#) [DMTH10H4M6SPS-13](#)
[IRF40SC240ARMA1](#)