



SEA & LAND ELECTRONIC CORP.

[www.sealand-pptc.com](http://www.sealand-pptc.com)

ALPHA-TOP TECHNOLOGY CORP.

[www.alpha-top.cn](http://www.alpha-top.cn)

---

## APPROVAL SHEET

MODEL NO.: SL0420~1265-SERIES

CUSTOMER:

CUSTOMER'S APPROVAL:

AUTHORIZED SIGNATURE/STAMP:

DATE

MANUFACTURER:

HEAD OFFICE:

13F.,No.120-10,Sec.3,Zhongshan Rd.,Zhonghe Dist.,New Taipei City 23544,Taiwan  
Tel: 886-2-8221-2567  
Fax:882-2-2225-7268  
E-mail:service@chipfast.com.tw

China Branch:

Factory Building B)Shuangpeng,Weibu Village, Qiuchang Town,  
Huiyang District, Huizhou City, Guangdong Province, P.R.C.)  
Tel: 86-752-3562001  
Fax:86-752-3558696  
E-mail:service@atpptc.com

Submitted by:

Chen

Approved by:

YC Lin

DATE:

25-Mar-24

# SPECIFICATION

**RoHS  
COMPLIANT**

<b>ITEM P/N</b>	<b>SL0420~1265-SERIES</b>
<b>PRODUCT</b>	<b>SMD Inductor</b>

## PACKING DIMENSIONS (mm)



0420	Dimensions
A	4.1 ± 0.5
B	4.5 ± 0.5
C	2.0 MAX
D	2.0 ± 0.5
E	1.0 ± 0.5
F	4.95 Typ
G	2.15 Typ
H	2.30 Typ

## EXPLANATION OF PART NUMBERS

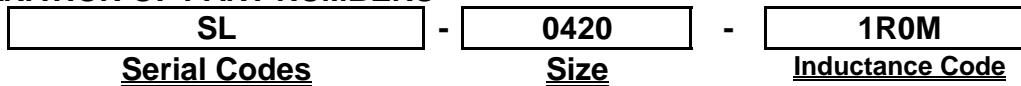

## ELECTRICAL CHARACTERISTICS

P/N	L0 Inductance μH ±20% @0A	DCR (mΩ)	Heat Rating Current	Saturation Current
		[ Max ]	I <sub>dc</sub> (AMP) Typical	I <sub>sat</sub> (AMP) Typical
SL0420-R22M	0.22	6.5	9.5	17.0
SL0420-R47M	0.47	12	7.5	13.0
SL0420-R56M	0.56	16	7.0	10.0
SL0420-R68M	0.68	18	6.5	8.0
SL0420-1R0M	1.00	27	6.0	7.0
SL0420-1R5M	1.50	45	5.0	6.5
SL0420-2R2M	2.20	58	4.5	5.0
SL0420-3R3M	3.30	89	3.5	4.0
SL0420-4R7M	4.70	105	3.0	3.5
SL0420-6R8M	6.80	150	2.5	3.0
SL0420-100M	10.00	200	2.0	2.5

- ⊙ All test Data is referenced to 25°C ambient
- ⊙ Typical Heat Rating DC Current would cause an approximately ΔT of 40°C
- ⊙ Typical Saturation DC Current would cause L<sub>0</sub> to drop approximately 30%
- ⊙ Operation Temperature Range : -40°C ~ 125°C
- ⊙ The Part temperature (ambient + ΔT) should not exceed 125°C under worst case operating conditions.
- ⊙ Circuit design, component placement, PWB trace size and thickness, airflow and other cooling provisions all effect the part temperature. Part temperature should be verified in the end application.

# SPECIFICATION

**RoHS  
COMPLIANT**

<b>ITEM P/N</b>	<b>SL0420~1265-SERIES</b>
<b>PRODUCT</b>	<b>SMD Inductor</b>

## PACKING DIMENSIONS (mm)



0520	Dimensions
A	5.2 ± 0.5
B	5.7 ± 0.5
C	2.0 MAX
D	2.0 ± 0.5
E	1.0 ± 0.5
F	5.20 Typ
G	2.00 Typ
H	2.50 Typ

## EXPLANATION OF PART NUMBERS

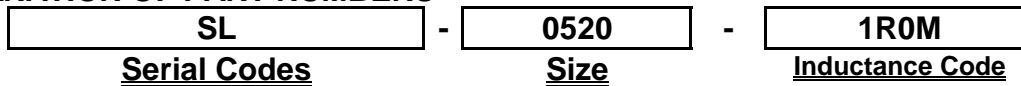

## ELECTRICAL CHARACTERISTICS

P/N	L0 Inductance μH ±20% @0A	DCR (mΩ)	Heat Rating Current	Saturation Current
		[ Max ]	I <sub>dc</sub> (AMP) Typical	I <sub>sat</sub> (AMP) Typical
SL0520-R22M	0.22	4.5	15.0	18.5
SL0520-R47M	0.47	9	10.5	15.5
SL0520-R56M	0.56	10	9.5	15.0
SL0520-R68M	0.68	13	9.0	11.5
SL0520-1R0M	1.00	17	8.0	9.0
SL0520-1R5M	1.50	27	7.0	8.0
SL0520-2R2M	2.20	34	5.0	7.0
SL0520-3R3M	3.30	58	4.5	5.5
SL0520-4R7M	4.70	85	3.5	4.5
SL0520-6R8M	6.80	120	2.8	3.5
SL0520-100M	10.00	155	2.5	3.0

- ⊙ All test Data is referenced to 25°C ambient
- ⊙ Typical Heat Rating DC Current would cause an approximately ΔT of 40°C
- ⊙ Typical Saturation DC Current would cause L<sub>0</sub> to drop approximately 30%
- ⊙ Operation Temperature Range : -40°C ~ 125°C
- ⊙ The Part temperature (ambient + ΔT) should not exceed 125°C under worst case operating conditions.
- ⊙ Circuit design, component placement, PWB trace size and thickness, airflow and other cooling provisions all effect the part temperature. Part temperature should be verified in the end application.

# SPECIFICATION

RoHS  
COMPLIANT

ITEM P/N	SL0420~1265-SERIES
PRODUCT	SMD Inductor

## PACKING DIMENSIONS (mm)

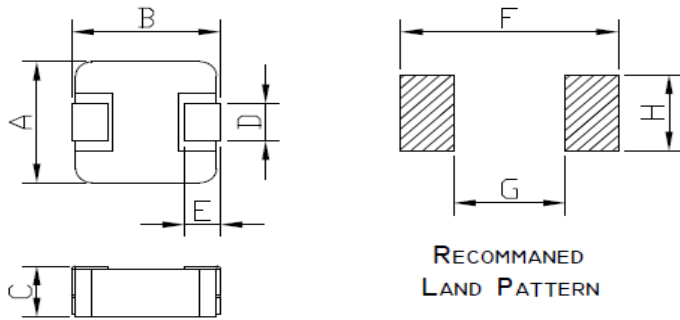

0530	Dimensions
A	5.2 ± 0.5
B	5.7 ± 0.5
C	3.0 MAX
D	2.0 ± 0.5
E	1.0 ± 0.5
F	5.20 Typ
G	2.00 Typ
H	2.50 Typ

## EXPLANATION OF PART NUMBERS

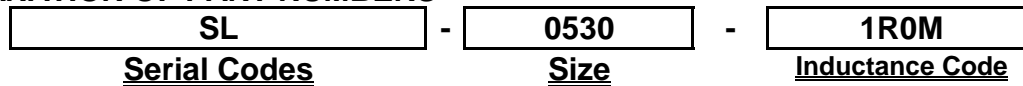

## ELECTRICAL CHARACTERISTICS

P/N	L0 Inductance μH ±20% @0A	DCR (mΩ)	Heat Rating Current	Saturation Current
		[ Max ]	I <sub>dc</sub> (AMP) Typical	I <sub>sat</sub> (AMP) Typical
SL0530-R22M	0.22	3.9	14.0	20.0
SL0530-R33M	0.33	5.5	13.0	18.0
SL0530-R47M	0.47	7.5	12.0	15.0
SL0530-R68M	0.68	10	10.0	14.0
SL0530-1R0M	1.00	14	9.0	13.0
SL0530-1R5M	1.50	25	8.0	9.5
SL0530-2R2M	2.20	29	7.0	8.5
SL0530-3R3M	3.30	38	5.5	7.5
SL0530-4R7M	4.70	55	4.5	6.0
SL0530-6R8M	6.80	70	3.5	5.0
SL0530-100M	10.00	115	3.0	4.0
SL0530-150M	15.00	175	2.5	3.0

- ⊙ All test Data is referenced to 25°C ambient
- ⊙ Typical Heat Rating DC Current would cause an approximately ΔT of 40°C
- ⊙ Typical Saturation DC Current would cause Lo to drop approximately 30%
- ⊙ Operation Temperature Range : -40°C ~ 125°C
- ⊙ The Part temperature (ambient + ΔT) should not exceed 125°C under worst case operating conditions.
- ⊙ Circuit design, component placement, PWB trace size and thickness, airflow and other cooling provisions all effect the part temperature. Part temperature should be verified in the end application.

# SPECIFICATION

RoHS  
COMPLIANT

<b>ITEM P/N</b>	<b>SL0420~1265-SERIES</b>
<b>PRODUCT</b>	<b>SMD Inductor</b>

## PACKING DIMENSIONS (mm)

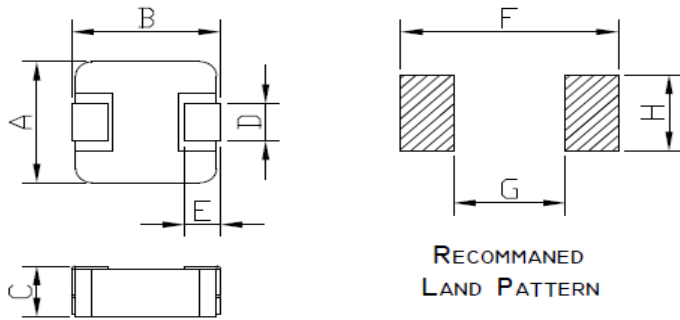

0620	Dimensions
A	6.6 ± 0.5
B	7.1 ± 0.5
C	2.0 MAX
D	3.0 ± 0.5
E	1.5 ± 0.5
F	8.40 Typ
G	3.60 Typ
H	3.50 Typ

## EXPLANATION OF PART NUMBERS

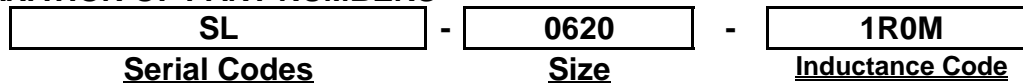

## ELECTRICAL CHARACTERISTICS

P/N	L0 Inductance μH ±20% @0A	DCR (mΩ)	Heat Rating Current	Saturation Current
		[ Max ]	Idc (AMP) Typical	Isat (AMP) Typical
SL0620-R10M	0.10	2.5	25.0	42.0
SL0620-R22M	0.22	3.5	16.0	25.0
SL0620-R33M	0.33	5.5	12.0	22.0
SL0620-R47M	0.47	8.4	11.5	18.0
SL0620-R68M	0.68	12	9.5	17.0
SL0620-1R0M	1.00	16	8.5	12.5
SL0620-1R5M	1.50	26	8.0	10.5
SL0620-2R2M	2.20	35	7.0	8.5
SL0620-3R3M	3.30	50	4.5	7.0
SL0620-4R7M	4.70	60	4.0	5.5
SL0620-6R8M	6.80	95	3.0	5.0
SL0620-100M	10.00	120	2.5	4.0

- ⊙ All test Data is referenced to 25°C ambient
- ⊙ Typical Heat Rating DC Current would cause an approximately ΔT of 40°C
- ⊙ Typical Saturation DC Current would cause Lo to drop approximately 30%
- ⊙ Operation Temperature Range : -40°C ~ 125°C
- ⊙ The Part temperature (ambient + ΔT) should not exceed 125°C under worst case operating conditions.
- ⊙ Circuit design, component placement, PWB trace size and thickness, airflow and other cooling provisions all effect the part temperature. Part temperature should be verified in the end application.

# SPECIFICATION

**RoHS  
COMPLIANT**

<b>ITEM P/N</b>	<b>SL0420~1265-SERIES</b>
<b>PRODUCT</b>	<b>SMD Inductor</b>

## PACKING DIMENSIONS (mm)

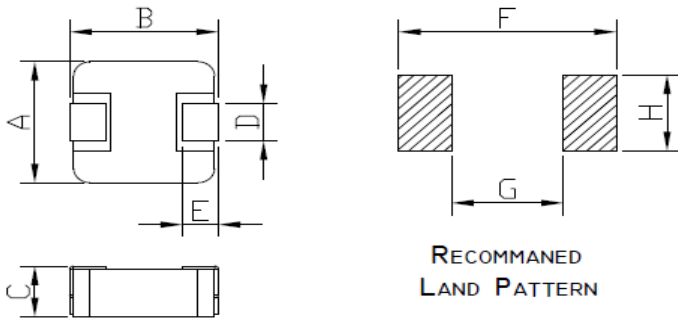

0624	Dimensions
A	6.6 ± 0.5
B	7.1 ± 0.5
C	2.4 MAX
D	3.0 ± 0.5
E	1.5 ± 0.5
F	8.40 Typ
G	3.60 Typ
H	3.50 Typ

## EXPLANATION OF PART NUMBERS

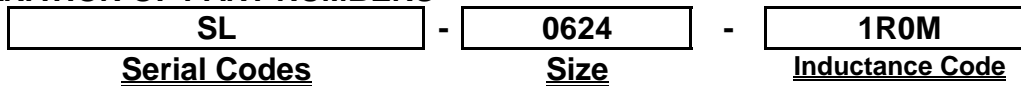

## ELECTRICAL CHARACTERISTICS

P/N	L0 Inductance μH ±20% @0A	DCR (mΩ)	Heat Rating Current	Saturation Current
		[ Max ]	Idc (AMP) Typical	Isat (AMP) Typical
SL0624-R10M	0.10	1.85	22.5	55.0
SL0624-R22M	0.22	3.2	21.0	33.0
SL0624-R33M	0.33	4.1	18.0	24.5
SL0624-R47M	0.47	5.1	15.0	21.0
SL0624-R68M	0.68	7	12.0	16.5
SL0624-1R0M	1.00	13.5	9.0	15.0
SL0624-1R5M	1.50	17.5	8.0	13.5
SL0624-2R2M	2.20	28	7.0	9.0
SL0624-3R3M	3.30	39	5.5	7.0
SL0624-4R7M	4.70	50	5.0	6.5
SL0624-6R8M	6.80	70	4.0	5.0
SL0624-100M	10.00	100	3.0	4.0
SL0624-150M	15.00	160	2.5	3.5
SL0624-220M	22.00	230	2.0	2.5

- ⊙ All test Data is referenced to 25°C ambient
- ⊙ Typical Heat Rating DC Current would cause an approximately ΔT of 40°C
- ⊙ Typical Saturation DC Current would cause Lo to drop approximately 30%
- ⊙ Operation Temperature Range : -40°C ~ 125°C
- ⊙ The Part temperature (ambient + ΔT) should not exceed 125°C under worst case operating conditions.
- ⊙ Circuit design, component placement, PWB trace size and thickness, airflow and other cooling provisions all effect the part temperature. Part temperature should be verified in the end application.

# SPECIFICATION

**RoHS  
COMPLIANT**

<b>ITEM P/N</b>	<b>SL0420~1265-SERIES</b>
<b>PRODUCT</b>	<b>SMD Inductor</b>

## PACKING DIMENSIONS (mm)

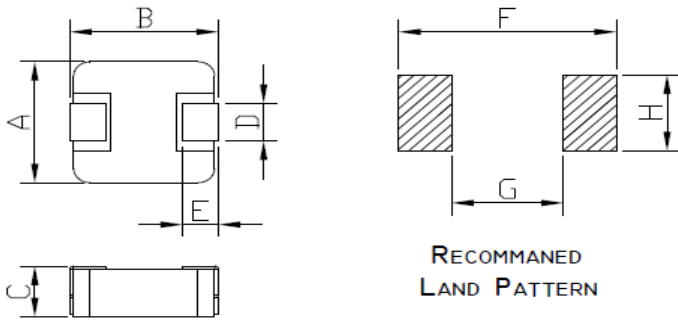

0630	Dimensions
A	6.6 ± 0.5
B	7.1 ± 0.5
C	3.0 MAX
D	3.0 ± 0.5
E	1.5 ± 0.5
F	8.40 Typ
G	3.60 Typ
H	3.50 Typ

## EXPLANATION OF PART NUMBERS

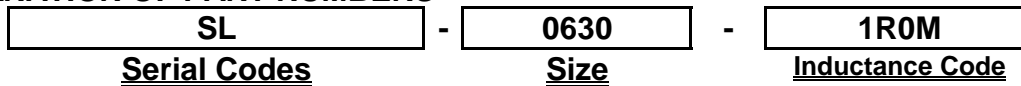

## ELECTRICAL CHARACTERISTICS

P/N	L0 Inductance μH ±20% @0A	DCR (mΩ)	Heat Rating Current	Saturation Current
		[ Max ]	Idc (AMP) Typical	Isat (AMP) Typical
SL0630-R33M	0.33	3.5	21.0	25.0
SL0630-R47M	0.47	4.5	18.0	20.0
SL0630-R56M	0.56	5	16.5	18.0
SL0630-R68M	0.68	5.8	16.0	17.0
SL0630-R82M	0.82	6	14.0	16.0
SL0630-1R0M	1.00	9.2	12.0	15.0
SL0630-1R5M	1.50	12.1	11.0	13.0
SL0630-2R2M	2.20	19.5	9.0	10.0
SL0630-3R3M	3.30	26	8.5	9.5
SL0630-4R7M	4.70	38	6.5	8.0
SL0630-6R8M	6.80	65	5.5	6.5
SL0630-100M	10.00	99.5	5.0	5.5
SL0630-150M	15.00	115	3.5	4.5
SL0630-220M	22.00	155	2.5	3.5
SL0630-330M	33.00	250	2.0	2.5
SL0630-470M	47.00	415	1.5	2.0

- ⊙ All test Data is referenced to 25°C ambient
- ⊙ Typical Heat Rating DC Current would cause an approximately ΔT of 40°C
- ⊙ Typical Saturation DC Current would cause Lo to drop approximately 30%
- ⊙ Operation Temperature Range : -40°C ~ 125°C
- ⊙ The Part temperature (ambient + ΔT) should not exceed 125°C under worst case operating conditions.
- ⊙ Circuit design, component placement, PWB trace size and thickness, airflow and other cooling provisions all effect the part temperature. Part temperature should be verified in the end application.

# SPECIFICATION

**RoHS  
COMPLIANT**

<b>ITEM P/N</b>	<b>SL0420~1265-SERIES</b>
<b>PRODUCT</b>	<b>SMD Inductor</b>

## PACKING DIMENSIONS (mm)

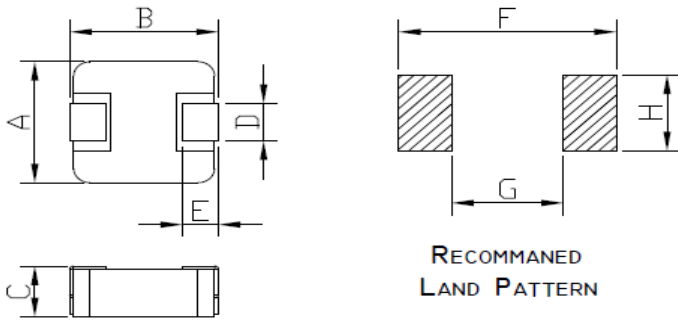

0650	Dimensions
A	6.6 ± 0.5
B	7.1 ± 0.5
C	5.0 MAX
D	3.0 ± 0.5
E	1.5 ± 0.5
F	8.40 Typ
G	3.60 Typ
H	3.50 Typ

## EXPLANATION OF PART NUMBERS

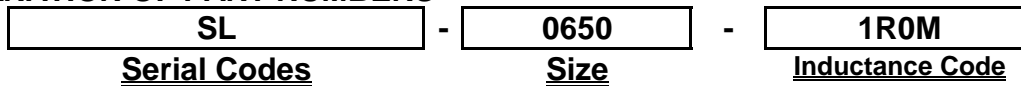

## ELECTRICAL CHARACTERISTICS

P/N	L0 Inductance μH ±20% @0A	DCR (mΩ)	Heat Rating Current	Saturation Current
		[ Max ]	Idc (AMP) Typical	Isat (AMP) Typical
SL0650-R22M	0.22	1.5	30.0	35.0
SL0650-R47M	0.47	5	20.0	24.0
SL0650-R56M	0.56	5.5	18.0	22.0
SL0650-R68M	0.68	6.5	14.0	18.0
SL0650-1R0M	1.00	8	12.0	16.0
SL0650-1R5M	1.50	10.5	9.5	13.0
SL0650-2R2M	2.20	12.5	9.0	12.0
SL0650-3R3M	3.30	22.5	8.5	10.0
SL0650-4R7M	4.70	27.5	7.0	9.0
SL0650-6R8M	6.80	35	6.0	8.0
SL0650-100M	10.00	58	5.0	7.0
SL0650-150M	15.00	65	4.0	5.0
SL0650-220M	22.00	98	3.0	5.0
SL0650-330M	33.00	186	2.5	3.5
SL0650-470M	47.00	255	2.0	2.5

- ⊙ All test Data is referenced to 25°C ambient
- ⊙ Typical Heat Rating DC Current would cause an approximately ΔT of 40°C
- ⊙ Typical Saturation DC Current would cause Lo to drop approximately 30%
- ⊙ Operation Temperature Range : -40°C ~ 125°C
- ⊙ The Part temperature (ambient + ΔT) should not exceed 125°C under worst case operating conditions.
- ⊙ Circuit design, component placement, PWB trace size and thickness, airflow and other cooling provisions all effect the part temperature. Part temperature should be verified in the end application.



# SPECIFICATION

RoHS  
COMPLIANT

ITEM P/N	SL0420~1265-SERIES
PRODUCT	SMD Inductor

### PACKING DIMENSIONS (mm)

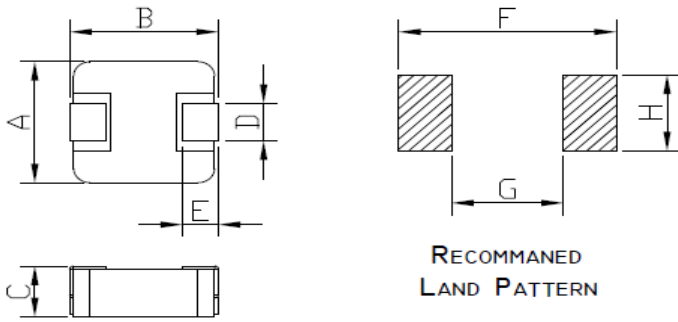

1040	Dimensions
A	10.5 ± 0.5
B	11.0 ± 0.5
C	4.0 MAX
D	3.0 ± 0.5
E	2.0 ± 0.5
F	12.5 Typ
G	6.00 Typ
H	4.00 Typ

### EXPLANATION OF PART NUMBERS

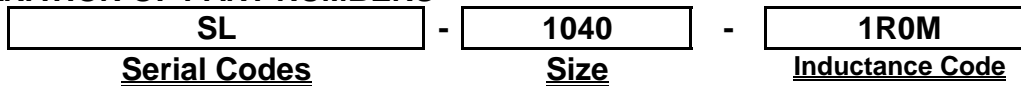

### ELECTRICAL CHARACTERISTICS

P/N	L0 Inductance μH ±20% @0A	DCR (mΩ)	Heat Rating Current	Saturation Current
		[ Max ]	Idc (AMP) Typical	Isat (AMP) Typical
SL1040-R47M	0.47	1.7	30.0	40.0
SL1040-R56M	0.56	1.9	25.0	33.0
SL1040-R68M	0.68	2.4	23.0	30.0
SL1040-1R0M	1.00	3.5	19.0	28.0
SL1040-1R5M	1.50	5	16.0	24.0
SL1040-2R2M	2.20	7	12.0	18.0
SL1040-3R3M	3.30	12	11.0	16.0
SL1040-4R7M	4.70	16	9.0	14.0
SL1040-5R6M	4.70	20	8.7	13.0
SL1040-6R8M	6.80	25	8.5	12.0
SL1040-8R2M	8.20	27	8.0	9.0
SL1040-100M	10.00	32	7.5	8.0
SL1040-150M	15.00	45	6.5	7.0
SL1040-220M	22.00	66	5.0	6.0
SL1040-330M	33.00	92	4.5	5.0
SL1040-470M	47.00	145	3.5	4.0

- ⊙ All test Data is referenced to 25°C ambient
- ⊙ Typical Heat Rating DC Current would cause an approximately ΔT of 40°C
- ⊙ Typical Saturation DC Current would cause Lo to drop approximately 30%
- ⊙ Operation Temperature Range : -40°C ~ 125°C
- ⊙ The Part temperature (ambient + ΔT) should not exceed 125°C under worst case operating conditions.
- ⊙ Circuit design, component placement, PWB trace size and thickness, airflow and other cooling provisions all effect the part temperature. Part temperature should be verified in the end application.

# SPECIFICATION

RoHS  
COMPLIANT

ITEM P/N	SL0420~1265-SERIES
PRODUCT	SMD Inductor

## PACKING DIMENSIONS (mm)

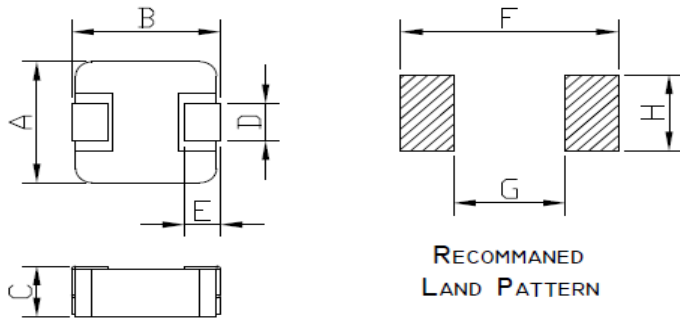

1050	Dimensions
A	10.5 ± 0.5
B	11.0 ± 0.5
C	5.0 MAX
D	3.0 ± 0.5
E	2.0 ± 0.5
F	12.5 Typ
G	6.00 Typ
H	4.00 Typ

## EXPLANATION OF PART NUMBERS

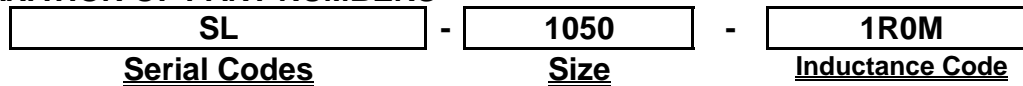

## ELECTRICAL CHARACTERISTICS

P/N	L0 Inductance μH ±20% @0A	DCR (mΩ)	Heat Rating Current	Saturation Current
		[ Max ]	I <sub>dc</sub> (AMP) Typical	I <sub>sat</sub> (AMP) Typical
SL1050-R82M	0.82	2.6	22.0	38.0
SL1050-1R0M	1.00	2.8	19.5	30.0
SL1050-1R5M	1.50	3.8	16.0	26.0
SL1050-2R2M	2.20	6	14.0	20.0
SL1050-3R3M	3.30	7.5	12.0	17.0
SL1050-4R7M	4.70	15	10.0	15.0
SL1050-5R6M	4.70	17	9.5	14.0
SL1050-6R8M	6.80	19.5	9.0	13.0
SL1050-8R2M	8.20	28	8.5	11.5
SL1050-100M	10.00	35	8.0	10.0
SL1050-150M	15.00	48	6.5	9.0
SL1050-220M	22.00	87	5.5	8.0
SL1050-330M	33.00	95	5.0	6.0
SL1050-470M	47.00	120	4.0	5.0
SL1050-680M	68.00	170	3.5	4.5
SL1050-101M	100.00	255	2.5	3.5

- ⊙ All test Data is referenced to 25°C ambient
- ⊙ Typical Heat Rating DC Current would cause an approximately ΔT of 40°C
- ⊙ Typical Saturation DC Current would cause L<sub>0</sub> to drop approximately 30%
- ⊙ Operation Temperature Range : -40°C ~ 125°C
- ⊙ The Part temperature (ambient + ΔT) should not exceed 125°C under worst case operating conditions.
- ⊙ Circuit design, component placement, PWB trace size and thickness, airflow and other cooling provisions all effect the part temperature. Part temperature should be verified in the end application.

# SPECIFICATION

RoHS  
COMPLIANT

<b>ITEM P/N</b>	<b>SL0420~1265-SERIES</b>
<b>PRODUCT</b>	<b>SMD Inductor</b>

## PACKING DIMENSIONS (mm)

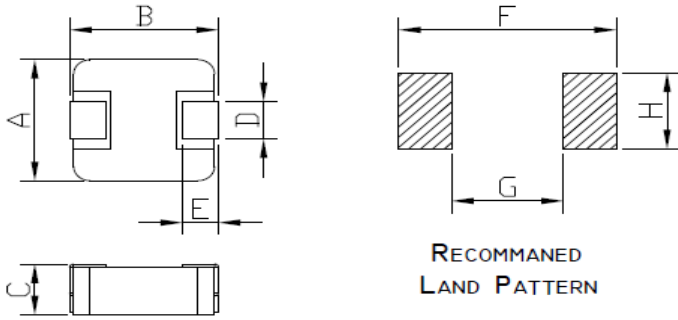

1250	Dimensions
A	12.8 ± 0.5
B	13.5 ± 0.5
C	5.0 MAX
D	3.5 ± 0.5
E	2.5 ± 0.5
F	14.5 Typ
G	8.00 Typ
H	4.50 Typ

## EXPLANATION OF PART NUMBERS

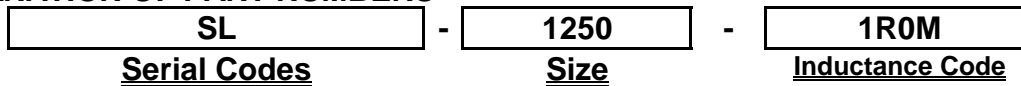

## ELECTRICAL CHARACTERISTICS

P/N	L0 Inductance μH ±20% @0A	DCR (mΩ)	Heat Rating Current	Saturation Current
		[ Max ]	Idc (AMP) Typical	Isat (AMP) Typical
SL1250-R82M	0.82	1.7	30.0	40.0
SL1250-1R0M	1.00	2.5	26.0	35.0
SL1250-1R5M	1.50	4	23.0	33.0
SL1250-2R2M	2.20	5.5	15.0	26.0
SL1250-3R3M	3.30	7.5	14.0	24.0
SL1250-4R7M	4.70	9	13.0	20.0
SL1250-5R6M	5.60	10.5	12.0	18.0
SL1250-6R8M	6.80	16.5	11.0	15.0
SL1250-8R2M	8.20	22	9.0	12.5
SL1250-100M	10.00	26.5	8.5	12.0
SL1250-150M	15.00	33	8.0	11.0
SL1250-220M	22.00	45	7.0	8.0
SL1250-330M	33.00	68	5.0	6.0

- ⊙ All test Data is referenced to 25°C ambient
- ⊙ Typical Heat Rating DC Current would cause an approximately ΔT of 40°C
- ⊙ Typical Saturation DC Current would cause Lo to drop approximately 30%
- ⊙ Operation Temperature Range : -40°C ~ 125°C
- ⊙ The Part temperature (ambient + ΔT) should not exceed 125°C under worst case operating conditions.
- ⊙ Circuit design, component placement, PWB trace size and thickness, airflow and other cooling provisions all effect the part temperature. Part temperature should be verified in the end application.

# SPECIFICATION

RoHS  
COMPLIANT

ITEM P/N	SL0420~1265-SERIES
PRODUCT	SMD Inductor

## PACKING DIMENSIONS (mm)

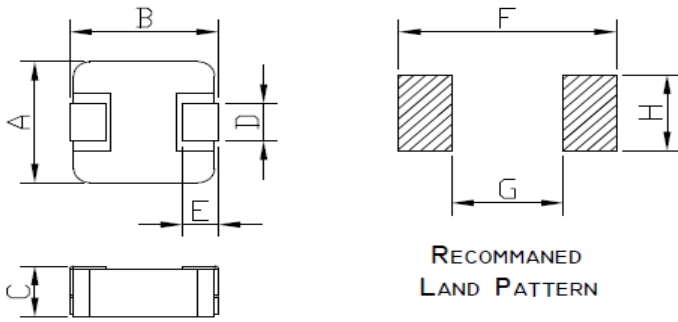

1265	Dimensions
A	12.8 ± 0.5
B	13.5 ± 0.5
C	6.5 MAX
D	3.5 ± 0.5
E	2.5 ± 0.5
F	14.5 Typ
G	8.00 Typ
H	4.50 Typ

## EXPLANATION OF PART NUMBERS

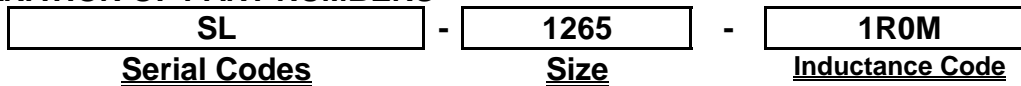

## ELECTRICAL CHARACTERISTICS

P/N	L0 Inductance μH ±20% @0A	DCR (mΩ)	Heat Rating Current	Saturation Current
		[ Max ]	I <sub>dc</sub> (AMP) Typical	I <sub>sat</sub> (AMP) Typical
SL1265-1R0M	1.00	1	24.0	40.0
SL1265-1R5M	1.50	1.8	23.0	30.0
SL1265-2R2M	2.20	3.2	21.0	27.0
SL1265-3R3M	3.30	6.5	15.0	24.0
SL1265-4R7M	4.70	7.5	15.0	22.0
SL1265-5R6M	5.60	10.5	13.0	21.0
SL1265-6R8M	6.80	13.5	12.0	19.0
SL1265-8R2M	8.20	16	11.0	15.5
SL1265-100M	10.00	18	10.0	15.0
SL1265-150M	15.00	26	8.5	13.5
SL1265-220M	22.00	39.5	7.0	10.0
SL1265-330M	33.00	53	6.0	8.0
SL1265-470M	47.00	75	5.5	6.5
SL1265-680M	68.00	115	3.5	4.5
SL1265-101M	100.00	138	2.0	3.5

- ⊙ All test Data is referenced to 25°C ambient
- ⊙ Typical Heat Rating DC Current would cause an approximately ΔT of 40°C
- ⊙ Typical Saturation DC Current would cause L<sub>0</sub> to drop approximately 30%
- ⊙ Operation Temperature Range : -40°C ~ 125°C
- ⊙ The Part temperature (ambient + ΔT) should not exceed 125°C under worst case operating conditions.
- ⊙ Circuit design, component placement, PWB trace size and thickness, airflow and other cooling provisions all effect the part temperature. Part temperature should be verified in the end application.

# CHARACTERISTICS

RoHS  
COMPLIANT

ITEM P/N	SL0420~1265-SERIES
PRODUCT	SMD Inductor

## RECOMMENDED SOLDERING TEMP. GRAPH

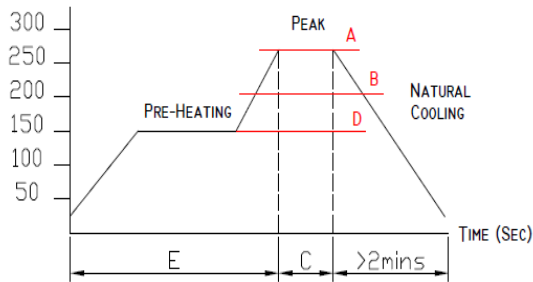

A	260°C
B	230°C
C	10 Sec
D	150°C
E	60~240 Sec

## MECHANICAL RELIABILITY

TEST	Specification & Requirement	Method Used
Solderability	The surface of terminal/pin tested shall be covered with new solder by 95%	Solder heat proof: Preheating: 180 ±10°C 90 seconds Soldering: 255 ±5°C for 3 ±1 sec
Shock	Inductance change within ± 5% Without mechanical damage	Drop down with 981m/s <sup>2</sup> (100G) shock Attitude upon a rubber block method shock testing machinem, 3 tests.
Vibration	Inductance change within ± 5% Without mechanical damage	Vibration frequency: 10Hz to 55Hz to 10Hz 60 seconds cycle Vibration time: 2 hours

## ENDURANCE RELIABILITY

TEST	Specification & Requirement	Method Used
Thermal Shock	Inductance change within ± 5% Without mechanical damage	-25°C, (30 mins) -> room temp. (5 mins) -> 125°C, (30 mins) -> room temp. (5 mins) 100 cycles
Heat Resistance	Inductance change within ± 5% Without mechanical damage	Apply IDC current @ 85°C ambient Duration: 1000 hrs
Humidity Resistance	Inductance change within ± 5% Without mechanical damage	Apply IDC current @ 60°C ambient Humidity: 90~95% Duration: 1000 hrs
Low Temp. Storing	Inductance change within ± 5% Without mechanical damage	Storing Temp. -25 ±2 °C for total 1,000 +4/-0 hours
High Temp. Storing	Inductance change within ± 5% Without mechanical damage	Storing Temp. 125 ±2 °C for total 1,000 +4/-0 hours

# PACKING FOR SMD

RoHS  
COMPLIANT

ITEM P/N

SL0420~1265-SERIES

PRODUCT

SMD Inductor

## CARRIERTAPEING REEL & CARRIER MATERIALS (PAPER PLASTICS) UNIT : (mm)

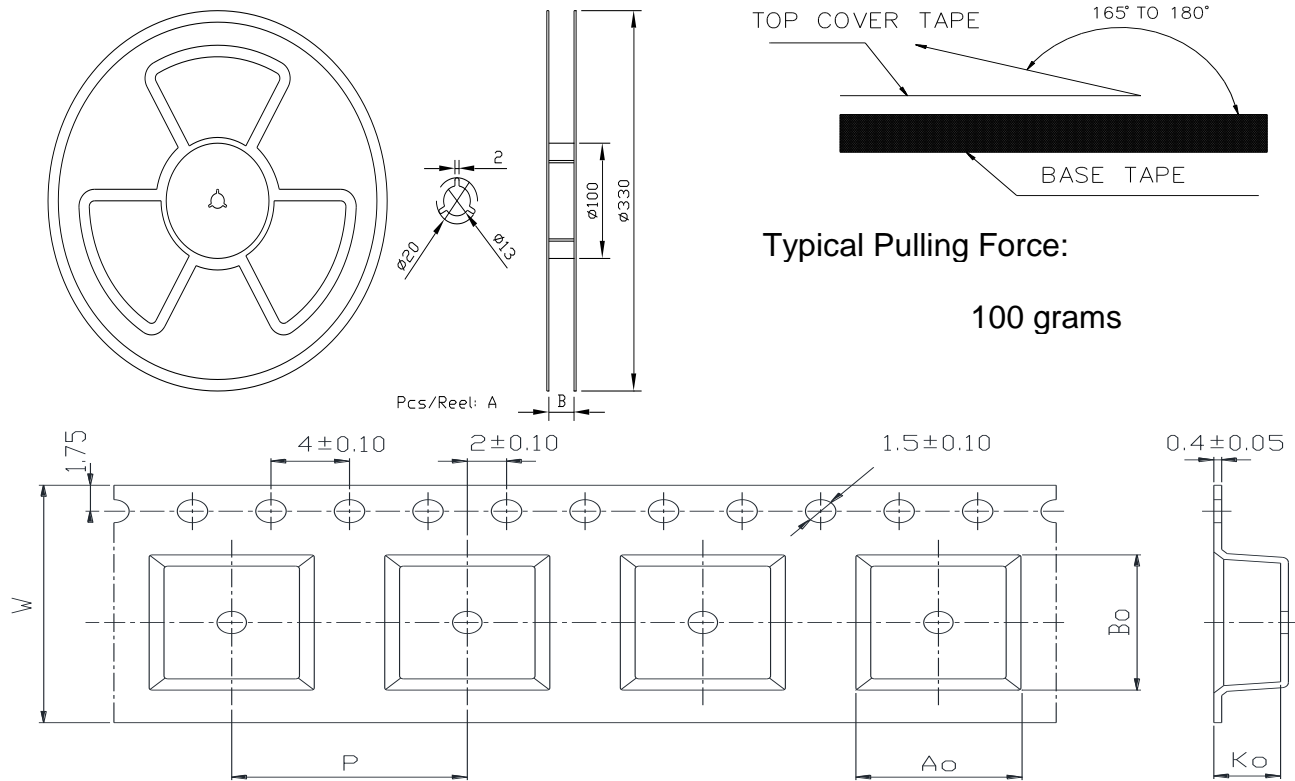

Series	A	B	W	Ao	Bo	Ko
0420	3000	12	12	4.6Typ	4.75 Typ	2.3Typ
0520	2000	12.5	12	5.7Typ	5.90 Typ	2.3Typ
0530	2000	12.5	12	5.7Typ	5.90 Typ	3.6Typ
0620	2000	17	16	6.9Typ	7.6 Typ	2.3Typ
0624	1000	17	16	6.9Typ	7.6 Typ	2.3Typ
0630	1000	17	16	6.9Typ	7.6 Typ	3.3Typ
0650	1000	17	16	6.9Typ	7.6 Typ	5.4Typ
1040	800	25	24	11.0Typ	12.6 Typ	4.3Typ
1050	800	25	24	11.0Typ	12.6 Typ	5.4Typ
1250	500	25	24	13.1Typ	15.0 Typ	5.3Typ
1265	500	25	24	13.1Typ	15.0 Typ	6.8Typ

## X-ON Electronics

Largest Supplier of Electrical and Electronic Components

*Click to view similar products for [Fixed Inductors](#) category:*

*Click to view products by [TECHFUSE](#) manufacturer:*

Other Similar products are found below :

[CR32NP-100KC](#) [70F224AI](#) [MHQ1005P10NJ](#) [MHQ1005P1N0S](#) [MHQ1005P2N4S](#) [MHQ1005P3N6S](#) [MHQ1005P5N1S](#) [MHQ1005P8N2J](#)  
[PE-53601NL](#) [PE-53602NL](#) [PG0936.113NLT](#) [9220-20](#) [9310-16](#) [PM06-2N7](#) [PM06-39NJ](#) [A01TK](#) [1206CS-471XJ](#) [HC2-R47-R](#) [HC8-1R2-R](#)  
[HCF1305-3R3-R](#) [1206CS-151XG](#) [RCH664NP-4R7M](#) [RCP1317NP-391L](#) [DH2280-4R7M](#) [DS1608C-106](#) [B10TJ](#) [B82498B3101J000](#) [ELJ-](#)  
[RE27NJF2](#) [1812CS-153XJ](#) [1812CS-183XJ](#) [1812CS-223XJ](#) [1812LS-104XJ](#) [1812LS-105XJ](#) [1812LS-124XJ](#) [1812LS-154XJ](#) [1812LS-223XJ](#)  
[1812LS-224XJ](#) [1812LS-563XJ](#) [1812LS-683XJ](#) [1812LS-824XJ](#) [NIN-FB101JTR110F](#) [NIN-FB471JTR62F](#) [NIN-FC1R5JTR220F](#) [NIN-](#)  
[HCR15JTRF](#) [NIN-HCR33JTRF](#) [NIN-HDR22JTRF](#) [NIN-HDR82JTRF](#) [NIN-HK2N7STRF](#) [NIN-PA150KTR370F](#) [NIN-PB100KTR550F](#)