



SEA & LAND ELECTRONIC CORP.

www.sealand-pptc.com

ALPHA-TOP TECHNOLOGY CORP.

www.alpha-top.cn

APPROVAL SHEET

MODEL NO.: SL0420~1265-SERIES

CUSTOMER:

CUSTOMER'S APPROVAL:

AUTHORIZED SIGNATURE/STAMP:

DATE

MANUFACTURER:

HEAD OFFICE:

13F.,No.120-10,Sec.3,Zhongshan Rd.,Zhonghe Dist.,New Taipei City 23544,Taiwan
Tel: 886-2-8221-2567
Fax:882-2-2225-7268
E-mail:service@chipfast.com.tw

China Branch:

Factory Building B)Shuangpeng,Weibu Village, Qiuchang Town,
Huiyang District, Huizhou City, Guangdong Province, P.R.C.)
Tel: 86-752-3562001
Fax:86-752-3558696
E-mail:service@atpptc.com

Submitted by:

Chen

Approved by:

YC Lin

DATE:

25-Mar-24

SPECIFICATION

RoHS
COMPLIANT

ITEM P/N	SL0420~1265-SERIES
PRODUCT	SMD Inductor

PACKING DIMENSIONS (mm)

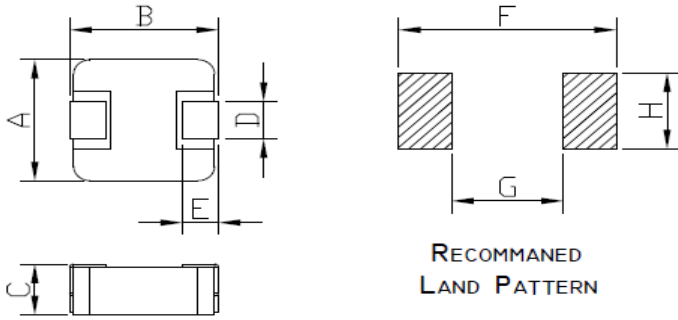

0420	Dimensions
A	4.1 ± 0.5
B	4.5 ± 0.5
C	2.0 MAX
D	2.0 ± 0.5
E	1.0 ± 0.5
F	4.95 Typ
G	2.15 Typ
H	2.30 Typ

EXPLANATION OF PART NUMBERS

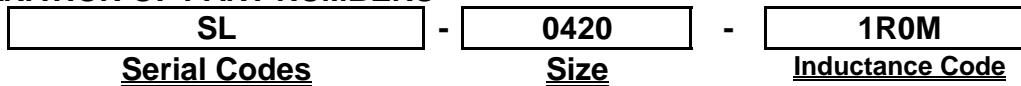

ELECTRICAL CHARACTERISTICS

P/N	L0 Inductance μH ±20% @0A	DCR (mΩ)	Heat Rating Current	Saturation Current
		[Max]	I _{dc} (AMP) Typical	I _{sat} (AMP) Typical
SL0420-R22M	0.22	6.5	9.5	17.0
SL0420-R47M	0.47	12	7.5	13.0
SL0420-R56M	0.56	16	7.0	10.0
SL0420-R68M	0.68	18	6.5	8.0
SL0420-1R0M	1.00	27	6.0	7.0
SL0420-1R5M	1.50	45	5.0	6.5
SL0420-2R2M	2.20	58	4.5	5.0
SL0420-3R3M	3.30	89	3.5	4.0
SL0420-4R7M	4.70	105	3.0	3.5
SL0420-6R8M	6.80	150	2.5	3.0
SL0420-100M	10.00	200	2.0	2.5

- ⊙ All test Data is referenced to 25°C ambient
- ⊙ Typical Heat Rating DC Current would cause an approximately ΔT of 40°C
- ⊙ Typical Saturation DC Current would cause L₀ to drop approximately 30%
- ⊙ Operation Temperature Range : -40°C ~ 125°C
- ⊙ The Part temperature (ambient + ΔT) should not exceed 125°C under worst case operating conditions.
- ⊙ Circuit design, component placement, PWB trace size and thickness, airflow and other cooling provisions all effect the part temperature. Part temperature should be verified in the end application.

SPECIFICATION

**RoHS
COMPLIANT**

ITEM P/N	SL0420~1265-SERIES
PRODUCT	SMD Inductor

PACKING DIMENSIONS (mm)



0520	Dimensions
A	5.2 ± 0.5
B	5.7 ± 0.5
C	2.0 MAX
D	2.0 ± 0.5
E	1.0 ± 0.5
F	5.20 Typ
G	2.00 Typ
H	2.50 Typ

EXPLANATION OF PART NUMBERS

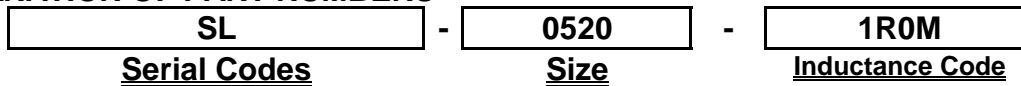

ELECTRICAL CHARACTERISTICS

P/N	L0 Inductance μH ±20% @0A	DCR (mΩ)	Heat Rating Current	Saturation Current
		[Max]	I _{dc} (AMP) Typical	I _{sat} (AMP) Typical
SL0520-R22M	0.22	4.5	15.0	18.5
SL0520-R47M	0.47	9	10.5	15.5
SL0520-R56M	0.56	10	9.5	15.0
SL0520-R68M	0.68	13	9.0	11.5
SL0520-1R0M	1.00	17	8.0	9.0
SL0520-1R5M	1.50	27	7.0	8.0
SL0520-2R2M	2.20	34	5.0	7.0
SL0520-3R3M	3.30	58	4.5	5.5
SL0520-4R7M	4.70	85	3.5	4.5
SL0520-6R8M	6.80	120	2.8	3.5
SL0520-100M	10.00	155	2.5	3.0

- ⊙ All test Data is referenced to 25°C ambient
- ⊙ Typical Heat Rating DC Current would cause an approximately ΔT of 40°C
- ⊙ Typical Saturation DC Current would cause L₀ to drop approximately 30%
- ⊙ Operation Temperature Range : -40°C ~ 125°C
- ⊙ The Part temperature (ambient + ΔT) should not exceed 125°C under worst case operating conditions.
- ⊙ Circuit design, component placement, PWB trace size and thickness, airflow and other cooling provisions all effect the part temperature. Part temperature should be verified in the end application.

SPECIFICATION

**RoHS
COMPLIANT**

ITEM P/N	SL0420~1265-SERIES
PRODUCT	SMD Inductor

PACKING DIMENSIONS (mm)

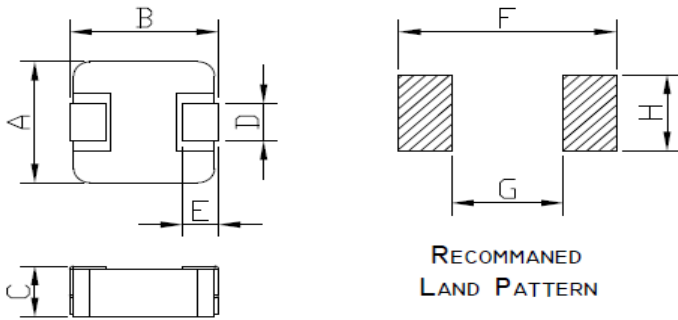

0530	Dimensions
A	5.2 ± 0.5
B	5.7 ± 0.5
C	3.0 MAX
D	2.0 ± 0.5
E	1.0 ± 0.5
F	5.20 Typ
G	2.00 Typ
H	2.50 Typ

EXPLANATION OF PART NUMBERS

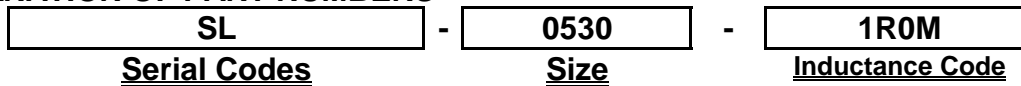

ELECTRICAL CHARACTERISTICS

P/N	L0 Inductance μH ±20% @0A	DCR (mΩ)	Heat Rating Current	Saturation Current
		[Max]	I _{dc} (AMP) Typical	I _{sat} (AMP) Typical
SL0530-R22M	0.22	3.9	14.0	20.0
SL0530-R33M	0.33	5.5	13.0	18.0
SL0530-R47M	0.47	7.5	12.0	15.0
SL0530-R68M	0.68	10	10.0	14.0
SL0530-1R0M	1.00	14	9.0	13.0
SL0530-1R5M	1.50	25	8.0	9.5
SL0530-2R2M	2.20	29	7.0	8.5
SL0530-3R3M	3.30	38	5.5	7.5
SL0530-4R7M	4.70	55	4.5	6.0
SL0530-6R8M	6.80	70	3.5	5.0
SL0530-100M	10.00	115	3.0	4.0
SL0530-150M	15.00	175	2.5	3.0

- ⊙ All test Data is referenced to 25°C ambient
- ⊙ Typical Heat Rating DC Current would cause an approximately ΔT of 40°C
- ⊙ Typical Saturation DC Current would cause Lo to drop approximately 30%
- ⊙ Operation Temperature Range : -40°C ~ 125°C
- ⊙ The Part temperature (ambient + ΔT) should not exceed 125°C under worst case operating conditions.
- ⊙ Circuit design, component placement, PWB trace size and thickness, airflow and other cooling provisions all effect the part temperature. Part temperature should be verified in the end application.

SPECIFICATION

**RoHS
COMPLIANT**

ITEM P/N	SL0420~1265-SERIES
PRODUCT	SMD Inductor

PACKING DIMENSIONS (mm)

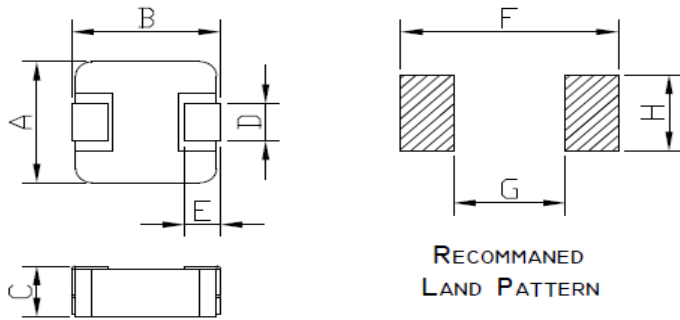

0620	Dimensions
A	6.6 ± 0.5
B	7.1 ± 0.5
C	2.0 MAX
D	3.0 ± 0.5
E	1.5 ± 0.5
F	8.40 Typ
G	3.60 Typ
H	3.50 Typ

EXPLANATION OF PART NUMBERS

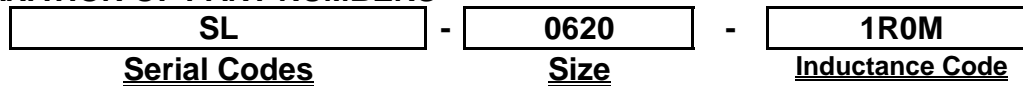

ELECTRICAL CHARACTERISTICS

P/N	L0 Inductance μH ±20% @0A	DCR (mΩ)	Heat Rating Current	Saturation Current
		[Max]	Idc (AMP) Typical	Isat (AMP) Typical
SL0620-R10M	0.10	2.5	25.0	42.0
SL0620-R22M	0.22	3.5	16.0	25.0
SL0620-R33M	0.33	5.5	12.0	22.0
SL0620-R47M	0.47	8.4	11.5	18.0
SL0620-R68M	0.68	12	9.5	17.0
SL0620-1R0M	1.00	16	8.5	12.5
SL0620-1R5M	1.50	26	8.0	10.5
SL0620-2R2M	2.20	35	7.0	8.5
SL0620-3R3M	3.30	50	4.5	7.0
SL0620-4R7M	4.70	60	4.0	5.5
SL0620-6R8M	6.80	95	3.0	5.0
SL0620-100M	10.00	120	2.5	4.0

- ⊙ All test Data is referenced to 25°C ambient
- ⊙ Typical Heat Rating DC Current would cause an approximately ΔT of 40°C
- ⊙ Typical Saturation DC Current would cause Lo to drop approximately 30%
- ⊙ Operation Temperature Range : -40°C ~ 125°C
- ⊙ The Part temperature (ambient + ΔT) should not exceed 125°C under worst case operating conditions.
- ⊙ Circuit design, component placement, PWB trace size and thickness, airflow and other cooling provisions all effect the part temperature. Part temperature should be verified in the end application.

SPECIFICATION

RoHS
COMPLIANT

ITEM P/N	SL0420~1265-SERIES
PRODUCT	SMD Inductor

PACKING DIMENSIONS (mm)

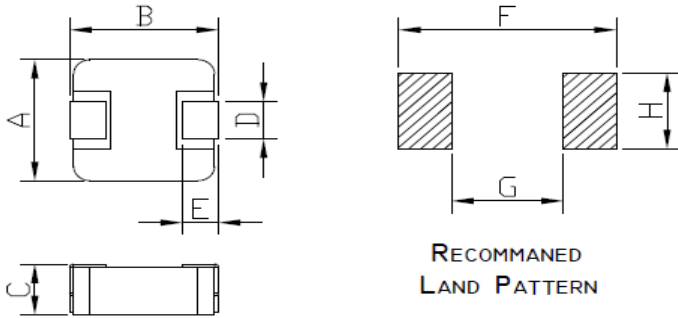

0624	Dimensions
A	6.6 ± 0.5
B	7.1 ± 0.5
C	2.4 MAX
D	3.0 ± 0.5
E	1.5 ± 0.5
F	8.40 Typ
G	3.60 Typ
H	3.50 Typ

EXPLANATION OF PART NUMBERS

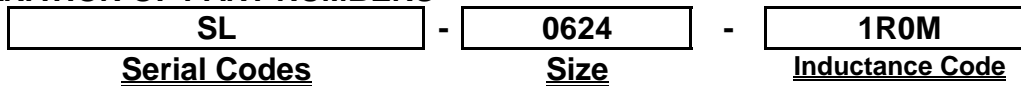

ELECTRICAL CHARACTERISTICS

P/N	L0 Inductance μH ±20% @0A	DCR (mΩ)	Heat Rating Current	Saturation Current
		[Max]	Idc (AMP) Typical	Isat (AMP) Typical
SL0624-R10M	0.10	1.85	22.5	55.0
SL0624-R22M	0.22	3.2	21.0	33.0
SL0624-R33M	0.33	4.1	18.0	24.5
SL0624-R47M	0.47	5.1	15.0	21.0
SL0624-R68M	0.68	7	12.0	16.5
SL0624-1R0M	1.00	13.5	9.0	15.0
SL0624-1R5M	1.50	17.5	8.0	13.5
SL0624-2R2M	2.20	28	7.0	9.0
SL0624-3R3M	3.30	39	5.5	7.0
SL0624-4R7M	4.70	50	5.0	6.5
SL0624-6R8M	6.80	70	4.0	5.0
SL0624-100M	10.00	100	3.0	4.0
SL0624-150M	15.00	160	2.5	3.5
SL0624-220M	22.00	230	2.0	2.5

- ⊙ All test Data is referenced to 25°C ambient
- ⊙ Typical Heat Rating DC Current would cause an approximately ΔT of 40°C
- ⊙ Typical Saturation DC Current would cause Lo to drop approximately 30%
- ⊙ Operation Temperature Range : -40°C ~ 125°C
- ⊙ The Part temperature (ambient + ΔT) should not exceed 125°C under worst case operating conditions.
- ⊙ Circuit design, component placement, PWB trace size and thickness, airflow and other cooling provisions all effect the part temperature. Part temperature should be verified in the end application.

SPECIFICATION

**RoHS
COMPLIANT**

ITEM P/N	SL0420~1265-SERIES
PRODUCT	SMD Inductor

PACKING DIMENSIONS (mm)

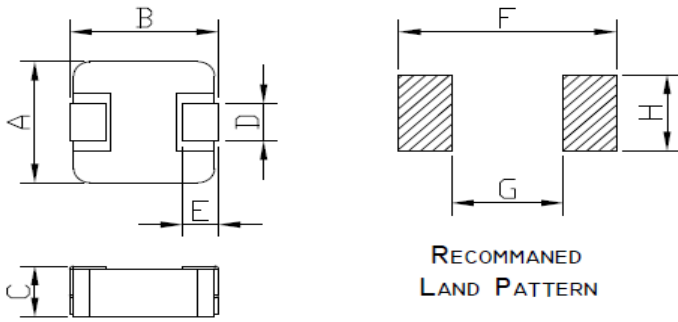

0630	Dimensions
A	6.6 ± 0.5
B	7.1 ± 0.5
C	3.0 MAX
D	3.0 ± 0.5
E	1.5 ± 0.5
F	8.40 Typ
G	3.60 Typ
H	3.50 Typ

EXPLANATION OF PART NUMBERS

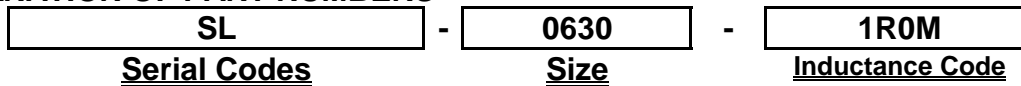

ELECTRICAL CHARACTERISTICS

P/N	L0 Inductance μH ±20% @0A	DCR (mΩ)	Heat Rating Current	Saturation Current
		[Max]	Idc (AMP) Typical	Isat (AMP) Typical
SL0630-R33M	0.33	3.5	21.0	25.0
SL0630-R47M	0.47	4.5	18.0	20.0
SL0630-R56M	0.56	5	16.5	18.0
SL0630-R68M	0.68	5.8	16.0	17.0
SL0630-R82M	0.82	6	14.0	16.0
SL0630-1R0M	1.00	9.2	12.0	15.0
SL0630-1R5M	1.50	12.1	11.0	13.0
SL0630-2R2M	2.20	19.5	9.0	10.0
SL0630-3R3M	3.30	26	8.5	9.5
SL0630-4R7M	4.70	38	6.5	8.0
SL0630-6R8M	6.80	65	5.5	6.5
SL0630-100M	10.00	99.5	5.0	5.5
SL0630-150M	15.00	115	3.5	4.5
SL0630-220M	22.00	155	2.5	3.5
SL0630-330M	33.00	250	2.0	2.5
SL0630-470M	47.00	415	1.5	2.0

- ⊙ All test Data is referenced to 25°C ambient
- ⊙ Typical Heat Rating DC Current would cause an approximately ΔT of 40°C
- ⊙ Typical Saturation DC Current would cause Lo to drop approximately 30%
- ⊙ Operation Temperature Range : -40°C ~ 125°C
- ⊙ The Part temperature (ambient + ΔT) should not exceed 125°C under worst case operating conditions.
- ⊙ Circuit design, component placement, PWB trace size and thickness, airflow and other cooling provisions all effect the part temperature. Part temperature should be verified in the end application.

SPECIFICATION

RoHS
COMPLIANT

ITEM P/N	SL0420~1265-SERIES
PRODUCT	SMD Inductor

PACKING DIMENSIONS (mm)

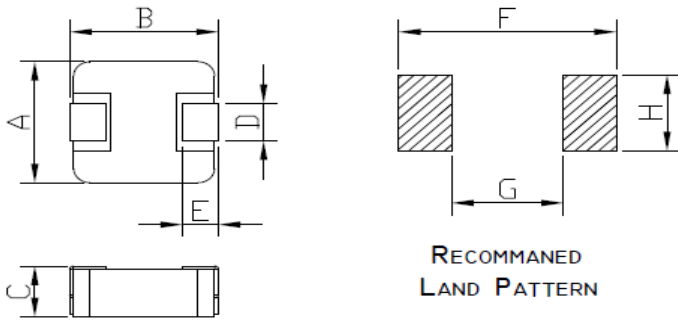

0650	Dimensions
A	6.6 ± 0.5
B	7.1 ± 0.5
C	5.0 MAX
D	3.0 ± 0.5
E	1.5 ± 0.5
F	8.40 Typ
G	3.60 Typ
H	3.50 Typ

EXPLANATION OF PART NUMBERS

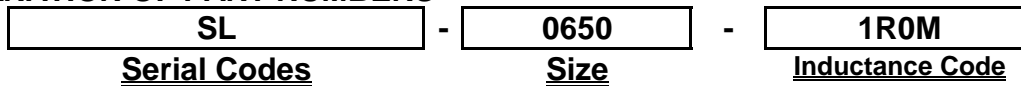

ELECTRICAL CHARACTERISTICS

P/N	L0 Inductance μH ±20% @0A	DCR (mΩ)	Heat Rating Current	Saturation Current
		[Max]	Idc (AMP) Typical	Isat (AMP) Typical
SL0650-R22M	0.22	1.5	30.0	35.0
SL0650-R47M	0.47	5	20.0	24.0
SL0650-R56M	0.56	5.5	18.0	22.0
SL0650-R68M	0.68	6.5	14.0	18.0
SL0650-1R0M	1.00	8	12.0	16.0
SL0650-1R5M	1.50	10.5	9.5	13.0
SL0650-2R2M	2.20	12.5	9.0	12.0
SL0650-3R3M	3.30	22.5	8.5	10.0
SL0650-4R7M	4.70	27.5	7.0	9.0
SL0650-6R8M	6.80	35	6.0	8.0
SL0650-100M	10.00	58	5.0	7.0
SL0650-150M	15.00	65	4.0	5.0
SL0650-220M	22.00	98	3.0	5.0
SL0650-330M	33.00	186	2.5	3.5
SL0650-470M	47.00	255	2.0	2.5

- ⊙ All test Data is referenced to 25°C ambient
- ⊙ Typical Heat Rating DC Current would cause an approximately ΔT of 40°C
- ⊙ Typical Saturation DC Current would cause Lo to drop approximately 30%
- ⊙ Operation Temperature Range : -40°C ~ 125°C
- ⊙ The Part temperature (ambient + ΔT) should not exceed 125°C under worst case operating conditions.
- ⊙ Circuit design, component placement, PWB trace size and thickness, airflow and other cooling provisions all effect the part temperature. Part temperature should be verified in the end application.

SPECIFICATION

RoHS
COMPLIANT

ITEM P/N	SL0420~1265-SERIES
PRODUCT	SMD Inductor

PACKING DIMENSIONS (mm)

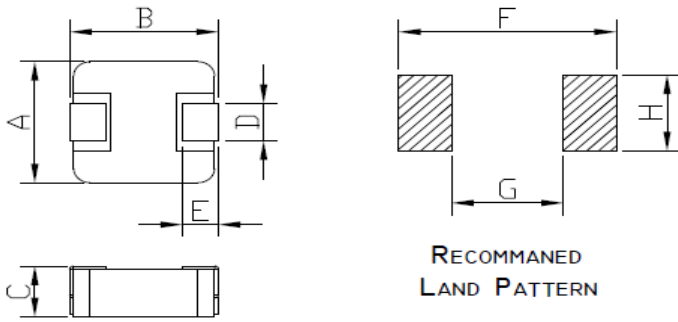

1040	Dimensions
A	10.5 ± 0.5
B	11.0 ± 0.5
C	4.0 MAX
D	3.0 ± 0.5
E	2.0 ± 0.5
F	12.5 Typ
G	6.00 Typ
H	4.00 Typ

EXPLANATION OF PART NUMBERS

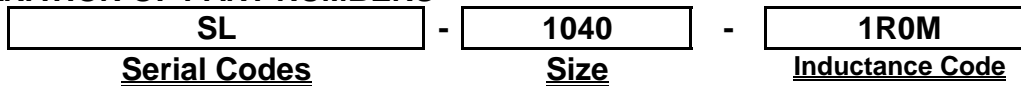

ELECTRICAL CHARACTERISTICS

P/N	L0 Inductance μH ±20% @0A	DCR (mΩ)	Heat Rating Current	Saturation Current
		[Max]	Idc (AMP) Typical	Isat (AMP) Typical
SL1040-R47M	0.47	1.7	30.0	40.0
SL1040-R56M	0.56	1.9	25.0	33.0
SL1040-R68M	0.68	2.4	23.0	30.0
SL1040-1R0M	1.00	3.5	19.0	28.0
SL1040-1R5M	1.50	5	16.0	24.0
SL1040-2R2M	2.20	7	12.0	18.0
SL1040-3R3M	3.30	12	11.0	16.0
SL1040-4R7M	4.70	16	9.0	14.0
SL1040-5R6M	4.70	20	8.7	13.0
SL1040-6R8M	6.80	25	8.5	12.0
SL1040-8R2M	8.20	27	8.0	9.0
SL1040-100M	10.00	32	7.5	8.0
SL1040-150M	15.00	45	6.5	7.0
SL1040-220M	22.00	66	5.0	6.0
SL1040-330M	33.00	92	4.5	5.0
SL1040-470M	47.00	145	3.5	4.0

- ⊙ All test Data is referenced to 25°C ambient
- ⊙ Typical Heat Rating DC Current would cause an approximately ΔT of 40°C
- ⊙ Typical Saturation DC Current would cause Lo to drop approximately 30%
- ⊙ Operation Temperature Range : -40°C ~ 125°C
- ⊙ The Part temperature (ambient + ΔT) should not exceed 125°C under worst case operating conditions.
- ⊙ Circuit design, component placement, PWB trace size and thickness, airflow and other cooling provisions all effect the part temperature. Part temperature should be verified in the end application.

SPECIFICATION

**RoHS
COMPLIANT**

ITEM P/N	SL0420~1265-SERIES
PRODUCT	SMD Inductor

PACKING DIMENSIONS (mm)

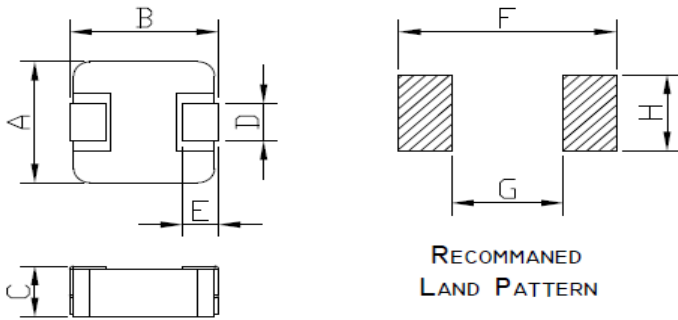

1050	Dimensions
A	10.5 ± 0.5
B	11.0 ± 0.5
C	5.0 MAX
D	3.0 ± 0.5
E	2.0 ± 0.5
F	12.5 Typ
G	6.00 Typ
H	4.00 Typ

EXPLANATION OF PART NUMBERS

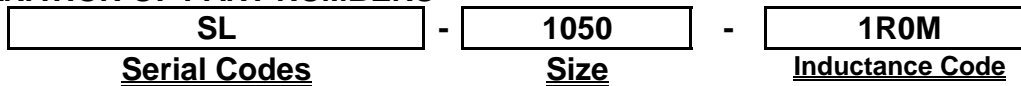

ELECTRICAL CHARACTERISTICS

P/N	L0 Inductance μH ±20% @0A	DCR (mΩ)	Heat Rating Current	Saturation Current
		[Max]	I _{dc} (AMP) Typical	I _{sat} (AMP) Typical
SL1050-R82M	0.82	2.6	22.0	38.0
SL1050-1R0M	1.00	2.8	19.5	30.0
SL1050-1R5M	1.50	3.8	16.0	26.0
SL1050-2R2M	2.20	6	14.0	20.0
SL1050-3R3M	3.30	7.5	12.0	17.0
SL1050-4R7M	4.70	15	10.0	15.0
SL1050-5R6M	4.70	17	9.5	14.0
SL1050-6R8M	6.80	19.5	9.0	13.0
SL1050-8R2M	8.20	28	8.5	11.5
SL1050-100M	10.00	35	8.0	10.0
SL1050-150M	15.00	48	6.5	9.0
SL1050-220M	22.00	87	5.5	8.0
SL1050-330M	33.00	95	5.0	6.0
SL1050-470M	47.00	120	4.0	5.0
SL1050-680M	68.00	170	3.5	4.5
SL1050-101M	100.00	255	2.5	3.5

- ⊙ All test Data is referenced to 25°C ambient
- ⊙ Typical Heat Rating DC Current would cause an approximately ΔT of 40°C
- ⊙ Typical Saturation DC Current would cause L₀ to drop approximately 30%
- ⊙ Operation Temperature Range : -40°C ~ 125°C
- ⊙ The Part temperature (ambient + ΔT) should not exceed 125°C under worst case operating conditions.
- ⊙ Circuit design, component placement, PWB trace size and thickness, airflow and other cooling provisions all effect the part temperature. Part temperature should be verified in the end application.

SPECIFICATION

RoHS
COMPLIANT

ITEM P/N	SL0420~1265-SERIES
PRODUCT	SMD Inductor

PACKING DIMENSIONS (mm)

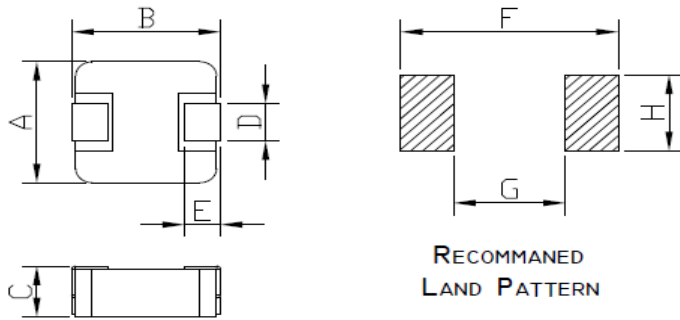

1250	Dimensions
A	12.8 ± 0.5
B	13.5 ± 0.5
C	5.0 MAX
D	3.5 ± 0.5
E	2.5 ± 0.5
F	14.5 Typ
G	8.00 Typ
H	4.50 Typ

EXPLANATION OF PART NUMBERS

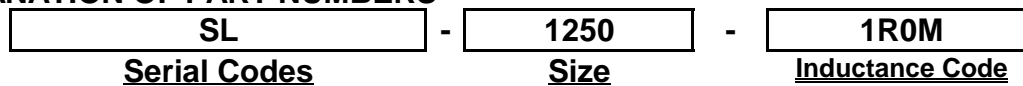

ELECTRICAL CHARACTERISTICS

P/N	L0 Inductance μH ±20% @0A	DCR (mΩ)	Heat Rating Current	Saturation Current
		[Max]	I _{dc} (AMP) Typical	I _{sat} (AMP) Typical
SL1250-R82M	0.82	1.7	30.0	40.0
SL1250-1R0M	1.00	2.5	26.0	35.0
SL1250-1R5M	1.50	4	23.0	33.0
SL1250-2R2M	2.20	5.5	15.0	26.0
SL1250-3R3M	3.30	7.5	14.0	24.0
SL1250-4R7M	4.70	9	13.0	20.0
SL1250-5R6M	5.60	10.5	12.0	18.0
SL1250-6R8M	6.80	16.5	11.0	15.0
SL1250-8R2M	8.20	22	9.0	12.5
SL1250-100M	10.00	26.5	8.5	12.0
SL1250-150M	15.00	33	8.0	11.0
SL1250-220M	22.00	45	7.0	8.0
SL1250-330M	33.00	68	5.0	6.0

- ⊙ All test Data is referenced to 25°C ambient
- ⊙ Typical Heat Rating DC Current would cause an approximately ΔT of 40°C
- ⊙ Typical Saturation DC Current would cause L₀ to drop approximately 30%
- ⊙ Operation Temperature Range : -40°C ~ 125°C
- ⊙ The Part temperature (ambient + ΔT) should not exceed 125°C under worst case operating conditions.
- ⊙ Circuit design, component placement, PWB trace size and thickness, airflow and other cooling provisions all effect the part temperature. Part temperature should be verified in the end application.

SPECIFICATION

RoHS
COMPLIANT

ITEM P/N	SL0420~1265-SERIES
PRODUCT	SMD Inductor

PACKING DIMENSIONS (mm)

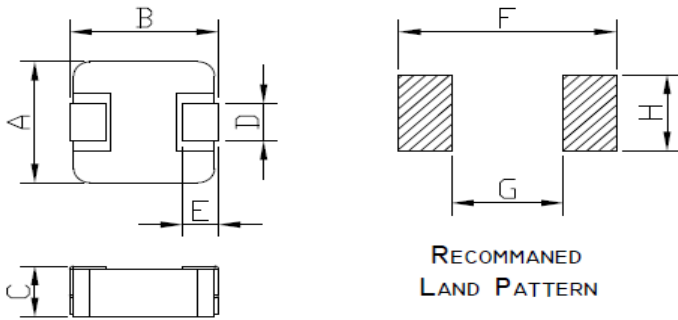

1265	Dimensions
A	12.8 ± 0.5
B	13.5 ± 0.5
C	6.5 MAX
D	3.5 ± 0.5
E	2.5 ± 0.5
F	14.5 Typ
G	8.00 Typ
H	4.50 Typ

EXPLANATION OF PART NUMBERS

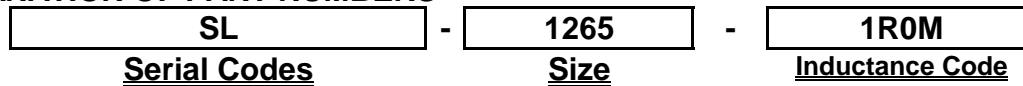

ELECTRICAL CHARACTERISTICS

P/N	L0 Inductance μH ±20% @0A	DCR (mΩ)	Heat Rating Current	Saturation Current
		[Max]	I _{dc} (AMP) Typical	I _{sat} (AMP) Typical
SL1265-1R0M	1.00	1	24.0	40.0
SL1265-1R5M	1.50	1.8	23.0	30.0
SL1265-2R2M	2.20	3.2	21.0	27.0
SL1265-3R3M	3.30	6.5	15.0	24.0
SL1265-4R7M	4.70	7.5	15.0	22.0
SL1265-5R6M	5.60	10.5	13.0	21.0
SL1265-6R8M	6.80	13.5	12.0	19.0
SL1265-8R2M	8.20	16	11.0	15.5
SL1265-100M	10.00	18	10.0	15.0
SL1265-150M	15.00	26	8.5	13.5
SL1265-220M	22.00	39.5	7.0	10.0
SL1265-330M	33.00	53	6.0	8.0
SL1265-470M	47.00	75	5.5	6.5
SL1265-680M	68.00	115	3.5	4.5
SL1265-101M	100.00	138	2.0	3.5

- ⊙ All test Data is referenced to 25°C ambient
- ⊙ Typical Heat Rating DC Current would cause an approximately ΔT of 40°C
- ⊙ Typical Saturation DC Current would cause L₀ to drop approximately 30%
- ⊙ Operation Temperature Range : -40°C ~ 125°C
- ⊙ The Part temperature (ambient + ΔT) should not exceed 125°C under worst case operating conditions.
- ⊙ Circuit design, component placement, PWB trace size and thickness, airflow and other cooling provisions all effect the part temperature. Part temperature should be verified in the end application.

CHARACTERISTICS

RoHS
COMPLIANT

ITEM P/N	SL0420~1265-SERIES
PRODUCT	SMD Inductor

RECOMMENDED SOLDERING TEMP. GRAPH

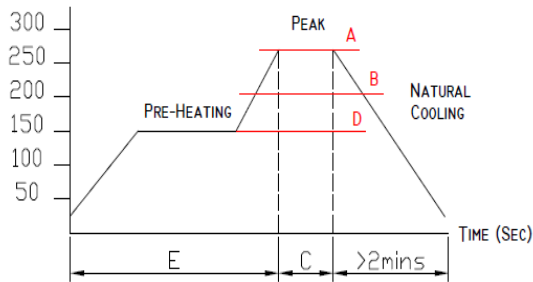

A	260°C
B	230°C
C	10 Sec
D	150°C
E	60~240 Sec

MECHANICAL RELIABILITY

TEST	Specification & Requirement	Method Used
Solderability	The surface of terminal/pin tested shall be covered with new solder by 95%	Solder heat proof: Preheating: 180 ±10°C 90 seconds Soldering: 255 ±5°C for 3 ±1 sec
Shock	Inductance change within ± 5% Without mechanical damage	Drop down with 981m/s ² (100G) shock Attitude upon a rubber block method shock testing machinem, 3 tests.
Vibration	Inductance change within ± 5% Without mechanical damage	Vibration frequency: 10Hz to 55Hz to 10Hz 60 seconds cycle Vibration time: 2 hours

ENDURANCE RELIABILITY

TEST	Specification & Requirement	Method Used
Thermal Shock	Inductance change within ± 5% Without mechanical damage	-25°C, (30 mins) -> room temp. (5 mins) -> 125°C, (30 mins) -> room temp. (5 mins) 100 cycles
Heat Resistance	Inductance change within ± 5% Without mechanical damage	Apply IDC current @ 85°C ambient Duration: 1000 hrs
Humidity Resistance	Inductance change within ± 5% Without mechanical damage	Apply IDC current @ 60°C ambient Humidity: 90~95% Duration: 1000 hrs
Low Temp. Storing	Inductance change within ± 5% Without mechanical damage	Storing Temp. -25 ±2 °C for total 1,000 +4/-0 hours
High Temp. Storing	Inductance change within ± 5% Without mechanical damage	Storing Temp. 125 ±2 °C for total 1,000 +4/-0 hours

PACKING FOR SMD

RoHS
COMPLIANT

ITEM P/N

SL0420~1265-SERIES

PRODUCT

SMD Inductor

CARRIERTAPEING REEL & CARRIER MATERIALS (PAPER PLASTICS) UNIT : (mm)

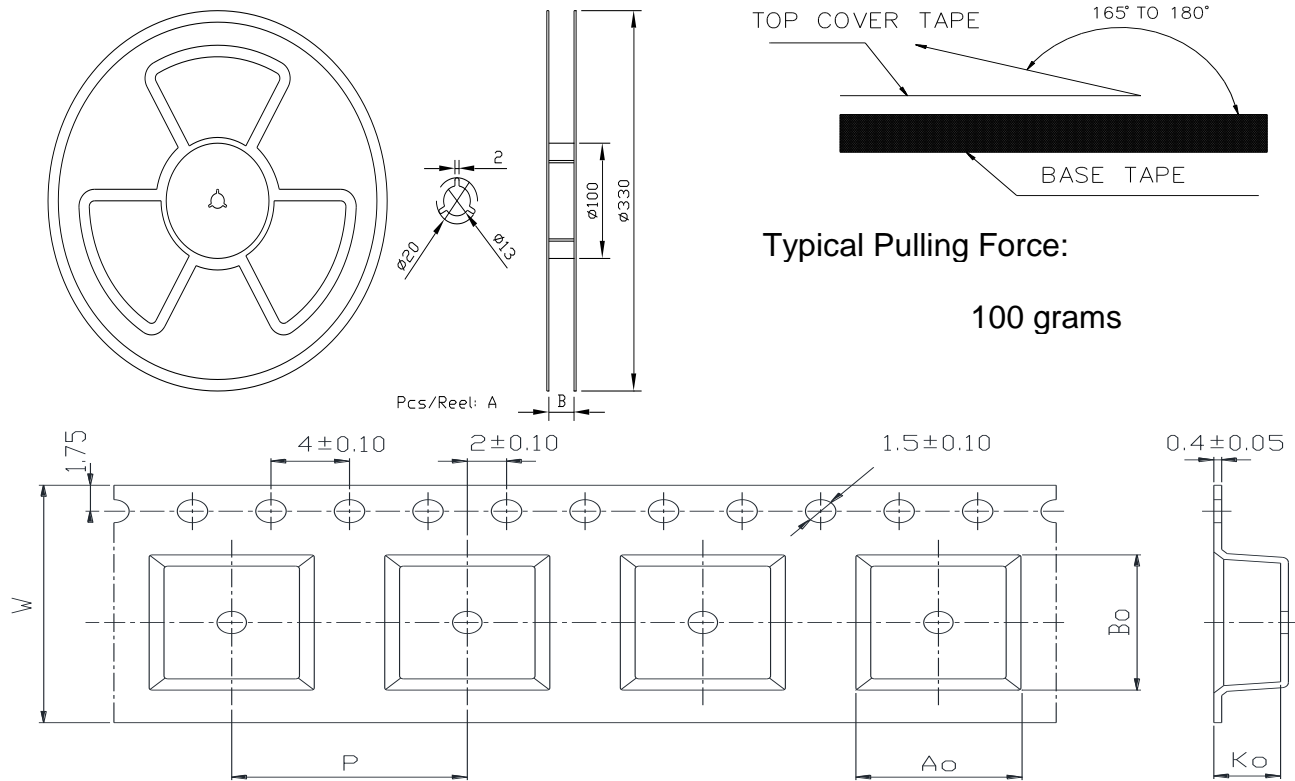

Typical Pulling Force:

100 grams

Series	A	B	W	Ao	Bo	Ko
0420	3000	12	12	4.6Typ	4.75 Typ	2.3Typ
0520	2000	12.5	12	5.7Typ	5.90 Typ	2.3Typ
0530	2000	12.5	12	5.7Typ	5.90 Typ	3.6Typ
0620	2000	17	16	6.9Typ	7.6 Typ	2.3Typ
0624	1000	17	16	6.9Typ	7.6 Typ	2.3Typ
0630	1000	17	16	6.9Typ	7.6 Typ	3.3Typ
0650	1000	17	16	6.9Typ	7.6 Typ	5.4Typ
1040	800	25	24	11.0Typ	12.6 Typ	4.3Typ
1050	800	25	24	11.0Typ	12.6 Typ	5.4Typ
1250	500	25	24	13.1Typ	15.0 Typ	5.3Typ
1265	500	25	24	13.1Typ	15.0 Typ	6.8Typ

X-ON Electronics

Largest Supplier of Electrical and Electronic Components

Click to view similar products for [Fixed Inductors](#) category:

Click to view products by [TECHFUSE](#) manufacturer:

Other Similar products are found below :

[CR32NP-100KC](#) [70F224AI](#) [MHQ1005P10NJ](#) [MHQ1005P1N0S](#) [MHQ1005P2N4S](#) [MHQ1005P3N6S](#) [MHQ1005P5N1S](#) [MHQ1005P8N2J](#)
[PE-53601NL](#) [PE-53602NL](#) [PG0936.113NLT](#) [9220-20](#) [9310-16](#) [PM06-2N7](#) [PM06-39NJ](#) [A01TK](#) [1206CS-471XJ](#) [HC2-R47-R](#) [HC8-1R2-R](#)
[HCF1305-3R3-R](#) [1206CS-151XG](#) [RCH664NP-4R7M](#) [RCP1317NP-391L](#) [DH2280-4R7M](#) [DS1608C-106](#) [B10TJ](#) [B82498B3101J000](#) [ELJ-](#)
[RE27NJF2](#) [1812CS-153XJ](#) [1812CS-183XJ](#) [1812CS-223XJ](#) [1812LS-104XJ](#) [1812LS-105XJ](#) [1812LS-124XJ](#) [1812LS-154XJ](#) [1812LS-223XJ](#)
[1812LS-224XJ](#) [1812LS-563XJ](#) [1812LS-683XJ](#) [1812LS-824XJ](#) [NIN-FB101JTR110F](#) [NIN-FB471JTR62F](#) [NIN-FC1R5JTR220F](#) [NIN-](#)
[HCR15JTRF](#) [NIN-HCR33JTRF](#) [NIN-HDR22JTRF](#) [NIN-HDR82JTRF](#) [NIN-HK2N7STRF](#) [NIN-PA150KTR370F](#) [NIN-PB100KTR550F](#)