



SEA & LAND ELECTRONIC CORP.

[www.sealand-pptc.com](http://www.sealand-pptc.com)

ALPHA-TOP TECHNOLOGY CORP.

[www.alpha-top.cn](http://www.alpha-top.cn)

---

## APPROVAL SHEET

MODEL NO.: SL0420~1265-SERIES

CUSTOMER:

CUSTOMER'S APPROVAL:

AUTHORIZED SIGNATURE/STAMP:

DATE

MANUFACTURER:

HEAD OFFICE:

13F.,No.120-10,Sec.3,Zhongshan Rd.,Zhonghe Dist.,New Taipei City 23544,Taiwan  
Tel: 886-2-8221-2567  
Fax:882-2-2225-7268  
E-mail:service@chipfast.com.tw

China Branch:

Factory Building B)Shuangpeng,Weibu Village, Qiuchang Town,  
Huiyang District, Huizhou City, Guangdong Province, P.R.C.)  
Tel: 86-752-3562001  
Fax:86-752-3558696  
E-mail:service@atpptc.com

Submitted by:

Chen

Approved by:

YC Lin

DATE:

25-Mar-24

# SPECIFICATION

**RoHS  
COMPLIANT**

|                 |                           |
|-----------------|---------------------------|
| <b>ITEM P/N</b> | <b>SL0420~1265-SERIES</b> |
| <b>PRODUCT</b>  | <b>SMD Inductor</b>       |

## PACKING DIMENSIONS (mm)



| 0420 | Dimensions |
|------|------------|
| A    | 4.1 ± 0.5  |
| B    | 4.5 ± 0.5  |
| C    | 2.0 MAX    |
| D    | 2.0 ± 0.5  |
| E    | 1.0 ± 0.5  |
| F    | 4.95 Typ   |
| G    | 2.15 Typ   |
| H    | 2.30 Typ   |

## EXPLANATION OF PART NUMBERS

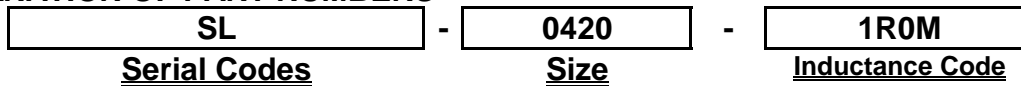

## ELECTRICAL CHARACTERISTICS

| P/N         | L0 Inductance<br>μH ±20%<br>@0A | DCR (mΩ) | Heat Rating<br>Current           | Saturation<br>Current             |
|-------------|---------------------------------|----------|----------------------------------|-----------------------------------|
|             |                                 | [ Max ]  | I <sub>dc</sub> (AMP)<br>Typical | I <sub>sat</sub> (AMP)<br>Typical |
| SL0420-R22M | 0.22                            | 6.5      | 9.5                              | 17.0                              |
| SL0420-R47M | 0.47                            | 12       | 7.5                              | 13.0                              |
| SL0420-R56M | 0.56                            | 16       | 7.0                              | 10.0                              |
| SL0420-R68M | 0.68                            | 18       | 6.5                              | 8.0                               |
| SL0420-1R0M | 1.00                            | 27       | 6.0                              | 7.0                               |
| SL0420-1R5M | 1.50                            | 45       | 5.0                              | 6.5                               |
| SL0420-2R2M | 2.20                            | 58       | 4.5                              | 5.0                               |
| SL0420-3R3M | 3.30                            | 89       | 3.5                              | 4.0                               |
| SL0420-4R7M | 4.70                            | 105      | 3.0                              | 3.5                               |
| SL0420-6R8M | 6.80                            | 150      | 2.5                              | 3.0                               |
| SL0420-100M | 10.00                           | 200      | 2.0                              | 2.5                               |

- ⊙ All test Data is referenced to 25°C ambient
- ⊙ Typical Heat Rating DC Current would cause an approximately ΔT of 40°C
- ⊙ Typical Saturation DC Current would cause L<sub>0</sub> to drop approximately 30%
- ⊙ Operation Temperature Range : -40°C ~ 125°C
- ⊙ The Part temperature (ambient + ΔT) should not exceed 125°C under worst case operating conditions.
- ⊙ Circuit design, component placement, PWB trace size and thickness, airflow and other cooling provisions all effect the part temperature. Part temperature should be verified in the end application.

# SPECIFICATION

**RoHS  
COMPLIANT**

|                 |                           |
|-----------------|---------------------------|
| <b>ITEM P/N</b> | <b>SL0420~1265-SERIES</b> |
| <b>PRODUCT</b>  | <b>SMD Inductor</b>       |

## PACKING DIMENSIONS (mm)



| 0520 | Dimensions |
|------|------------|
| A    | 5.2 ± 0.5  |
| B    | 5.7 ± 0.5  |
| C    | 2.0 MAX    |
| D    | 2.0 ± 0.5  |
| E    | 1.0 ± 0.5  |
| F    | 5.20 Typ   |
| G    | 2.00 Typ   |
| H    | 2.50 Typ   |

## EXPLANATION OF PART NUMBERS

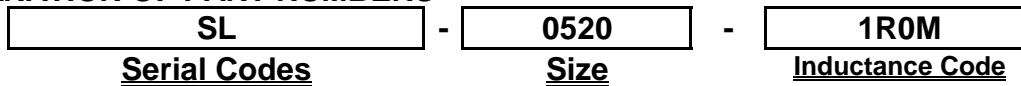

## ELECTRICAL CHARACTERISTICS

| P/N         | L0<br>Inductance<br>μH ±20%<br>@0A | DCR (mΩ) | Heat Rating<br>Current           | Saturation<br>Current             |
|-------------|------------------------------------|----------|----------------------------------|-----------------------------------|
|             |                                    | [ Max ]  | I <sub>dc</sub> (AMP)<br>Typical | I <sub>sat</sub> (AMP)<br>Typical |
| SL0520-R22M | 0.22                               | 4.5      | 15.0                             | 18.5                              |
| SL0520-R47M | 0.47                               | 9        | 10.5                             | 15.5                              |
| SL0520-R56M | 0.56                               | 10       | 9.5                              | 15.0                              |
| SL0520-R68M | 0.68                               | 13       | 9.0                              | 11.5                              |
| SL0520-1R0M | 1.00                               | 17       | 8.0                              | 9.0                               |
| SL0520-1R5M | 1.50                               | 27       | 7.0                              | 8.0                               |
| SL0520-2R2M | 2.20                               | 34       | 5.0                              | 7.0                               |
| SL0520-3R3M | 3.30                               | 58       | 4.5                              | 5.5                               |
| SL0520-4R7M | 4.70                               | 85       | 3.5                              | 4.5                               |
| SL0520-6R8M | 6.80                               | 120      | 2.8                              | 3.5                               |
| SL0520-100M | 10.00                              | 155      | 2.5                              | 3.0                               |

- ⊙ All test Data is referenced to 25°C ambient
- ⊙ Typical Heat Rating DC Current would cause an approximately ΔT of 40°C
- ⊙ Typical Saturation DC Current would cause L<sub>0</sub> to drop approximately 30%
- ⊙ Operation Temperature Range : -40°C ~ 125°C
- ⊙ The Part temperature (ambient + ΔT) should not exceed 125°C under worst case operating conditions.
- ⊙ Circuit design, component placement, PWB trace size and thickness, airflow and other cooling provisions all effect the part temperature. Part temperature should be verified in the end application.

# SPECIFICATION

**RoHS  
COMPLIANT**

|                 |                           |
|-----------------|---------------------------|
| <b>ITEM P/N</b> | <b>SL0420~1265-SERIES</b> |
| <b>PRODUCT</b>  | <b>SMD Inductor</b>       |

## PACKING DIMENSIONS (mm)

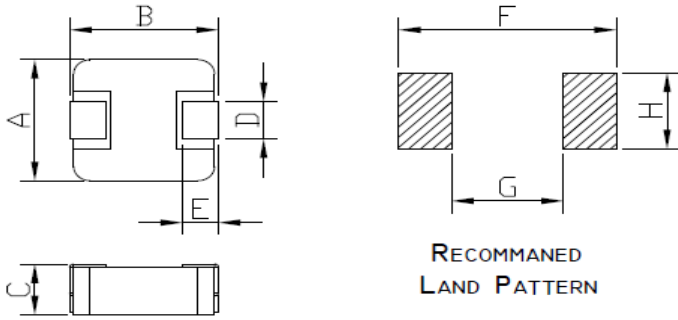

| 0530 | Dimensions |
|------|------------|
| A    | 5.2 ± 0.5  |
| B    | 5.7 ± 0.5  |
| C    | 3.0 MAX    |
| D    | 2.0 ± 0.5  |
| E    | 1.0 ± 0.5  |
| F    | 5.20 Typ   |
| G    | 2.00 Typ   |
| H    | 2.50 Typ   |

## EXPLANATION OF PART NUMBERS

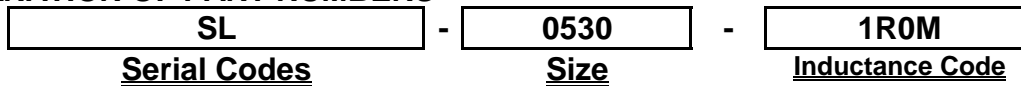

## ELECTRICAL CHARACTERISTICS

| P/N         | L0 Inductance<br>μH ±20%<br>@0A | DCR (mΩ) | Heat Rating<br>Current | Saturation<br>Current |
|-------------|---------------------------------|----------|------------------------|-----------------------|
|             |                                 | [ Max ]  | Idc (AMP)<br>Typical   | Isat (AMP)<br>Typical |
| SL0530-R22M | 0.22                            | 3.9      | 14.0                   | 20.0                  |
| SL0530-R33M | 0.33                            | 5.5      | 13.0                   | 18.0                  |
| SL0530-R47M | 0.47                            | 7.5      | 12.0                   | 15.0                  |
| SL0530-R68M | 0.68                            | 10       | 10.0                   | 14.0                  |
| SL0530-1R0M | 1.00                            | 14       | 9.0                    | 13.0                  |
| SL0530-1R5M | 1.50                            | 25       | 8.0                    | 9.5                   |
| SL0530-2R2M | 2.20                            | 29       | 7.0                    | 8.5                   |
| SL0530-3R3M | 3.30                            | 38       | 5.5                    | 7.5                   |
| SL0530-4R7M | 4.70                            | 55       | 4.5                    | 6.0                   |
| SL0530-6R8M | 6.80                            | 70       | 3.5                    | 5.0                   |
| SL0530-100M | 10.00                           | 115      | 3.0                    | 4.0                   |
| SL0530-150M | 15.00                           | 175      | 2.5                    | 3.0                   |

- ⊙ All test Data is referenced to 25°C ambient
- ⊙ Typical Heat Rating DC Current would cause an approximately ΔT of 40°C
- ⊙ Typical Saturation DC Current would cause Lo to drop approximately 30%
- ⊙ Operation Temperature Range : -40°C ~ 125°C
- ⊙ The Part temperature (ambient + ΔT) should not exceed 125°C under worst case operating conditions.
- ⊙ Circuit design, component placement, PWB trace size and thickness, airflow and other cooling provisions all effect the part temperature. Part temperature should be verified in the end application.

# SPECIFICATION

**RoHS  
COMPLIANT**

|                 |                           |
|-----------------|---------------------------|
| <b>ITEM P/N</b> | <b>SL0420~1265-SERIES</b> |
| <b>PRODUCT</b>  | <b>SMD Inductor</b>       |

## PACKING DIMENSIONS (mm)

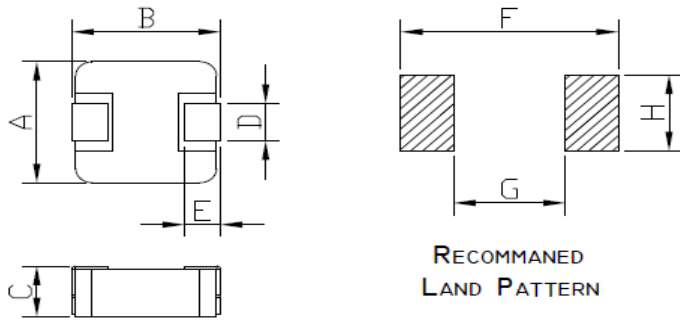

| 0620 | Dimensions |
|------|------------|
| A    | 6.6 ± 0.5  |
| B    | 7.1 ± 0.5  |
| C    | 2.0 MAX    |
| D    | 3.0 ± 0.5  |
| E    | 1.5 ± 0.5  |
| F    | 8.40 Typ   |
| G    | 3.60 Typ   |
| H    | 3.50 Typ   |

## EXPLANATION OF PART NUMBERS

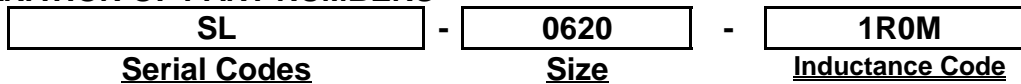

## ELECTRICAL CHARACTERISTICS

| P/N         | L0 Inductance<br>μH ±20%<br>@0A | DCR (mΩ) | Heat Rating<br>Current | Saturation<br>Current |
|-------------|---------------------------------|----------|------------------------|-----------------------|
|             |                                 | [ Max ]  | Idc (AMP)<br>Typical   | Isat (AMP)<br>Typical |
| SL0620-R10M | 0.10                            | 2.5      | 25.0                   | 42.0                  |
| SL0620-R22M | 0.22                            | 3.5      | 16.0                   | 25.0                  |
| SL0620-R33M | 0.33                            | 5.5      | 12.0                   | 22.0                  |
| SL0620-R47M | 0.47                            | 8.4      | 11.5                   | 18.0                  |
| SL0620-R68M | 0.68                            | 12       | 9.5                    | 17.0                  |
| SL0620-1R0M | 1.00                            | 16       | 8.5                    | 12.5                  |
| SL0620-1R5M | 1.50                            | 26       | 8.0                    | 10.5                  |
| SL0620-2R2M | 2.20                            | 35       | 7.0                    | 8.5                   |
| SL0620-3R3M | 3.30                            | 50       | 4.5                    | 7.0                   |
| SL0620-4R7M | 4.70                            | 60       | 4.0                    | 5.5                   |
| SL0620-6R8M | 6.80                            | 95       | 3.0                    | 5.0                   |
| SL0620-100M | 10.00                           | 120      | 2.5                    | 4.0                   |

- ⊙ All test Data is referenced to 25°C ambient
- ⊙ Typical Heat Rating DC Current would cause an approximately ΔT of 40°C
- ⊙ Typical Saturation DC Current would cause Lo to drop approximately 30%
- ⊙ Operation Temperature Range : -40°C ~ 125°C
- ⊙ The Part temperature (ambient + ΔT) should not exceed 125°C under worst case operating conditions.
- ⊙ Circuit design, component placement, PWB trace size and thickness, airflow and other cooling provisions all effect the part temperature. Part temperature should be verified in the end application.

# SPECIFICATION

RoHS  
COMPLIANT

|          |                    |
|----------|--------------------|
| ITEM P/N | SL0420~1265-SERIES |
| PRODUCT  | SMD Inductor       |

## PACKING DIMENSIONS (mm)

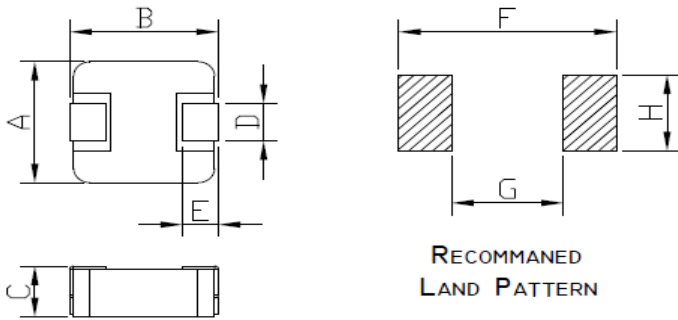

| 0624 | Dimensions |
|------|------------|
| A    | 6.6 ± 0.5  |
| B    | 7.1 ± 0.5  |
| C    | 2.4 MAX    |
| D    | 3.0 ± 0.5  |
| E    | 1.5 ± 0.5  |
| F    | 8.40 Typ   |
| G    | 3.60 Typ   |
| H    | 3.50 Typ   |

## EXPLANATION OF PART NUMBERS

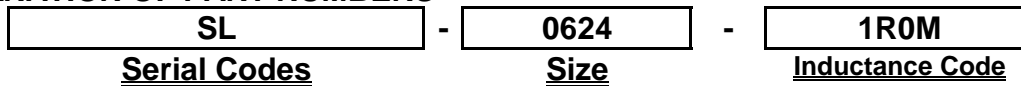

## ELECTRICAL CHARACTERISTICS

| P/N         | L0 Inductance<br>μH ±20%<br>@0A | DCR (mΩ) | Heat Rating<br>Current | Saturation<br>Current |
|-------------|---------------------------------|----------|------------------------|-----------------------|
|             |                                 | [ Max ]  | Idc (AMP)<br>Typical   | Isat (AMP)<br>Typical |
| SL0624-R10M | 0.10                            | 1.85     | 22.5                   | 55.0                  |
| SL0624-R22M | 0.22                            | 3.2      | 21.0                   | 33.0                  |
| SL0624-R33M | 0.33                            | 4.1      | 18.0                   | 24.5                  |
| SL0624-R47M | 0.47                            | 5.1      | 15.0                   | 21.0                  |
| SL0624-R68M | 0.68                            | 7        | 12.0                   | 16.5                  |
| SL0624-1R0M | 1.00                            | 13.5     | 9.0                    | 15.0                  |
| SL0624-1R5M | 1.50                            | 17.5     | 8.0                    | 13.5                  |
| SL0624-2R2M | 2.20                            | 28       | 7.0                    | 9.0                   |
| SL0624-3R3M | 3.30                            | 39       | 5.5                    | 7.0                   |
| SL0624-4R7M | 4.70                            | 50       | 5.0                    | 6.5                   |
| SL0624-6R8M | 6.80                            | 70       | 4.0                    | 5.0                   |
| SL0624-100M | 10.00                           | 100      | 3.0                    | 4.0                   |
| SL0624-150M | 15.00                           | 160      | 2.5                    | 3.5                   |
| SL0624-220M | 22.00                           | 230      | 2.0                    | 2.5                   |

- ⊙ All test Data is referenced to 25°C ambient
- ⊙ Typical Heat Rating DC Current would cause an approximately ΔT of 40°C
- ⊙ Typical Saturation DC Current would cause Lo to drop approximately 30%
- ⊙ Operation Temperature Range : -40°C ~ 125°C
- ⊙ The Part temperature (ambient + ΔT) should not exceed 125°C under worst case operating conditions.
- ⊙ Circuit design, component placement, PWB trace size and thickness, airflow and other cooling provisions all effect the part temperature. Part temperature should be verified in the end application.

# SPECIFICATION

RoHS  
COMPLIANT

|          |                    |
|----------|--------------------|
| ITEM P/N | SL0420~1265-SERIES |
| PRODUCT  | SMD Inductor       |

## PACKING DIMENSIONS (mm)

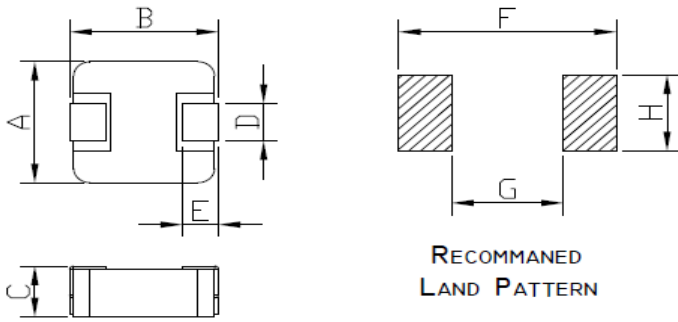

| 0630 | Dimensions |
|------|------------|
| A    | 6.6 ± 0.5  |
| B    | 7.1 ± 0.5  |
| C    | 3.0 MAX    |
| D    | 3.0 ± 0.5  |
| E    | 1.5 ± 0.5  |
| F    | 8.40 Typ   |
| G    | 3.60 Typ   |
| H    | 3.50 Typ   |

## EXPLANATION OF PART NUMBERS

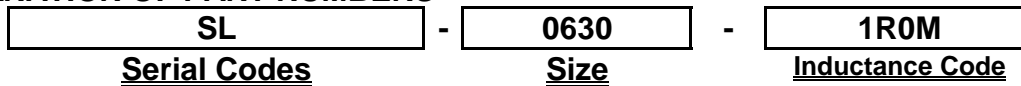

## ELECTRICAL CHARACTERISTICS

| P/N         | L0 Inductance<br>μH ±20%<br>@0A | DCR (mΩ) | Heat Rating Current  | Saturation Current    |
|-------------|---------------------------------|----------|----------------------|-----------------------|
|             |                                 | [ Max ]  | Idc (AMP)<br>Typical | Isat (AMP)<br>Typical |
| SL0630-R33M | 0.33                            | 3.5      | 21.0                 | 25.0                  |
| SL0630-R47M | 0.47                            | 4.5      | 18.0                 | 20.0                  |
| SL0630-R56M | 0.56                            | 5        | 16.5                 | 18.0                  |
| SL0630-R68M | 0.68                            | 5.8      | 16.0                 | 17.0                  |
| SL0630-R82M | 0.82                            | 6        | 14.0                 | 16.0                  |
| SL0630-1R0M | 1.00                            | 9.2      | 12.0                 | 15.0                  |
| SL0630-1R5M | 1.50                            | 12.1     | 11.0                 | 13.0                  |
| SL0630-2R2M | 2.20                            | 19.5     | 9.0                  | 10.0                  |
| SL0630-3R3M | 3.30                            | 26       | 8.5                  | 9.5                   |
| SL0630-4R7M | 4.70                            | 38       | 6.5                  | 8.0                   |
| SL0630-6R8M | 6.80                            | 65       | 5.5                  | 6.5                   |
| SL0630-100M | 10.00                           | 99.5     | 5.0                  | 5.5                   |
| SL0630-150M | 15.00                           | 115      | 3.5                  | 4.5                   |
| SL0630-220M | 22.00                           | 155      | 2.5                  | 3.5                   |
| SL0630-330M | 33.00                           | 250      | 2.0                  | 2.5                   |
| SL0630-470M | 47.00                           | 415      | 1.5                  | 2.0                   |

- ⊙ All test Data is referenced to 25°C ambient
- ⊙ Typical Heat Rating DC Current would cause an approximately ΔT of 40°C
- ⊙ Typical Saturation DC Current would cause Lo to drop approximately 30%
- ⊙ Operation Temperature Range : -40°C ~ 125°C
- ⊙ The Part temperature (ambient + ΔT) should not exceed 125°C under worst case operating conditions.
- ⊙ Circuit design, component placement, PWB trace size and thickness, airflow and other cooling provisions all effect the part temperature. Part temperature should be verified in the end application.

# SPECIFICATION

RoHS  
COMPLIANT

|          |                    |
|----------|--------------------|
| ITEM P/N | SL0420~1265-SERIES |
| PRODUCT  | SMD Inductor       |

## PACKING DIMENSIONS (mm)

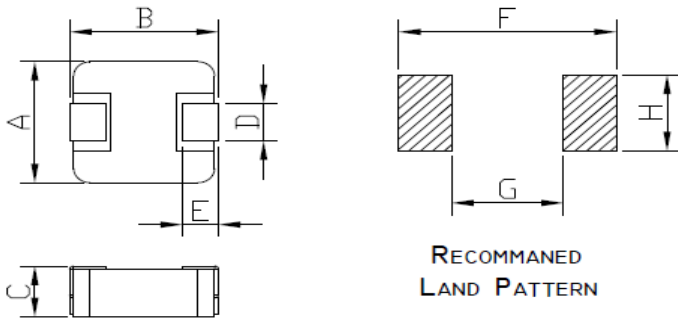

| 0650 | Dimensions |
|------|------------|
| A    | 6.6 ± 0.5  |
| B    | 7.1 ± 0.5  |
| C    | 5.0 MAX    |
| D    | 3.0 ± 0.5  |
| E    | 1.5 ± 0.5  |
| F    | 8.40 Typ   |
| G    | 3.60 Typ   |
| H    | 3.50 Typ   |

## EXPLANATION OF PART NUMBERS

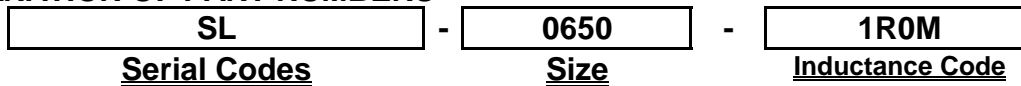

## ELECTRICAL CHARACTERISTICS

| P/N         | L0 Inductance<br>μH ±20%<br>@0A | DCR (mΩ) | Heat Rating Current  | Saturation Current    |
|-------------|---------------------------------|----------|----------------------|-----------------------|
|             |                                 | [ Max ]  | Idc (AMP)<br>Typical | Isat (AMP)<br>Typical |
| SL0650-R22M | 0.22                            | 1.5      | 30.0                 | 35.0                  |
| SL0650-R47M | 0.47                            | 5        | 20.0                 | 24.0                  |
| SL0650-R56M | 0.56                            | 5.5      | 18.0                 | 22.0                  |
| SL0650-R68M | 0.68                            | 6.5      | 14.0                 | 18.0                  |
| SL0650-1R0M | 1.00                            | 8        | 12.0                 | 16.0                  |
| SL0650-1R5M | 1.50                            | 10.5     | 9.5                  | 13.0                  |
| SL0650-2R2M | 2.20                            | 12.5     | 9.0                  | 12.0                  |
| SL0650-3R3M | 3.30                            | 22.5     | 8.5                  | 10.0                  |
| SL0650-4R7M | 4.70                            | 27.5     | 7.0                  | 9.0                   |
| SL0650-6R8M | 6.80                            | 35       | 6.0                  | 8.0                   |
| SL0650-100M | 10.00                           | 58       | 5.0                  | 7.0                   |
| SL0650-150M | 15.00                           | 65       | 4.0                  | 5.0                   |
| SL0650-220M | 22.00                           | 98       | 3.0                  | 5.0                   |
| SL0650-330M | 33.00                           | 186      | 2.5                  | 3.5                   |
| SL0650-470M | 47.00                           | 255      | 2.0                  | 2.5                   |

- ⊙ All test Data is referenced to 25°C ambient
- ⊙ Typical Heat Rating DC Current would cause an approximately ΔT of 40°C
- ⊙ Typical Saturation DC Current would cause Lo to drop approximately 30%
- ⊙ Operation Temperature Range : -40°C ~ 125°C
- ⊙ The Part temperature (ambient + ΔT) should not exceed 125°C under worst case operating conditions.
- ⊙ Circuit design, component placement, PWB trace size and thickness, airflow and other cooling provisions all effect the part temperature. Part temperature should be verified in the end application.



# SPECIFICATION

RoHS  
COMPLIANT

|          |                    |
|----------|--------------------|
| ITEM P/N | SL0420~1265-SERIES |
| PRODUCT  | SMD Inductor       |

## PACKING DIMENSIONS (mm)

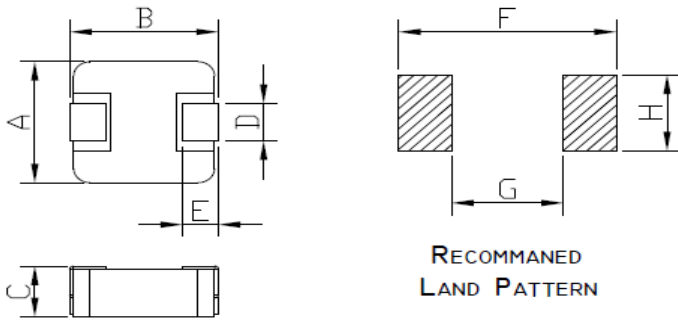

| 1040 | Dimensions |
|------|------------|
| A    | 10.5 ± 0.5 |
| B    | 11.0 ± 0.5 |
| C    | 4.0 MAX    |
| D    | 3.0 ± 0.5  |
| E    | 2.0 ± 0.5  |
| F    | 12.5 Typ   |
| G    | 6.00 Typ   |
| H    | 4.00 Typ   |

## EXPLANATION OF PART NUMBERS

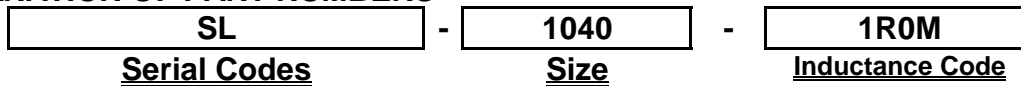

## ELECTRICAL CHARACTERISTICS

| P/N         | L0 Inductance<br>μH ±20%<br>@0A | DCR (mΩ) | Heat Rating<br>Current | Saturation<br>Current |
|-------------|---------------------------------|----------|------------------------|-----------------------|
|             |                                 | [ Max ]  | Idc (AMP)<br>Typical   | Isat (AMP)<br>Typical |
| SL1040-R47M | 0.47                            | 1.7      | 30.0                   | 40.0                  |
| SL1040-R56M | 0.56                            | 1.9      | 25.0                   | 33.0                  |
| SL1040-R68M | 0.68                            | 2.4      | 23.0                   | 30.0                  |
| SL1040-1R0M | 1.00                            | 3.5      | 19.0                   | 28.0                  |
| SL1040-1R5M | 1.50                            | 5        | 16.0                   | 24.0                  |
| SL1040-2R2M | 2.20                            | 7        | 12.0                   | 18.0                  |
| SL1040-3R3M | 3.30                            | 12       | 11.0                   | 16.0                  |
| SL1040-4R7M | 4.70                            | 16       | 9.0                    | 14.0                  |
| SL1040-5R6M | 4.70                            | 20       | 8.7                    | 13.0                  |
| SL1040-6R8M | 6.80                            | 25       | 8.5                    | 12.0                  |
| SL1040-8R2M | 8.20                            | 27       | 8.0                    | 9.0                   |
| SL1040-100M | 10.00                           | 32       | 7.5                    | 8.0                   |
| SL1040-150M | 15.00                           | 45       | 6.5                    | 7.0                   |
| SL1040-220M | 22.00                           | 66       | 5.0                    | 6.0                   |
| SL1040-330M | 33.00                           | 92       | 4.5                    | 5.0                   |
| SL1040-470M | 47.00                           | 145      | 3.5                    | 4.0                   |

- ⊙ All test Data is referenced to 25°C ambient
- ⊙ Typical Heat Rating DC Current would cause an approximately ΔT of 40°C
- ⊙ Typical Saturation DC Current would cause Lo to drop approximately 30%
- ⊙ Operation Temperature Range : -40°C ~ 125°C
- ⊙ The Part temperature (ambient + ΔT) should not exceed 125°C under worst case operating conditions.
- ⊙ Circuit design, component placement, PWB trace size and thickness, airflow and other cooling provisions all effect the part temperature. Part temperature should be verified in the end application.

# SPECIFICATION

RoHS  
COMPLIANT

|          |                    |
|----------|--------------------|
| ITEM P/N | SL0420~1265-SERIES |
| PRODUCT  | SMD Inductor       |

## PACKING DIMENSIONS (mm)



| 1050 | Dimensions |
|------|------------|
| A    | 10.5 ± 0.5 |
| B    | 11.0 ± 0.5 |
| C    | 5.0 MAX    |
| D    | 3.0 ± 0.5  |
| E    | 2.0 ± 0.5  |
| F    | 12.5 Typ   |
| G    | 6.00 Typ   |
| H    | 4.00 Typ   |

## EXPLANATION OF PART NUMBERS

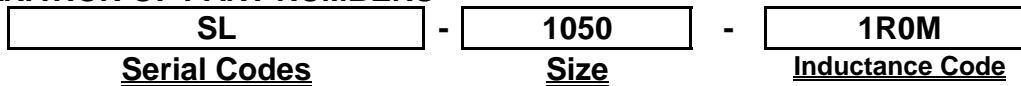

## ELECTRICAL CHARACTERISTICS

| P/N         | L0 Inductance<br>μH ±20%<br>@0A | DCR (mΩ) | Heat Rating<br>Current           | Saturation<br>Current             |
|-------------|---------------------------------|----------|----------------------------------|-----------------------------------|
|             |                                 | [ Max ]  | I <sub>dc</sub> (AMP)<br>Typical | I <sub>sat</sub> (AMP)<br>Typical |
| SL1050-R82M | 0.82                            | 2.6      | 22.0                             | 38.0                              |
| SL1050-1R0M | 1.00                            | 2.8      | 19.5                             | 30.0                              |
| SL1050-1R5M | 1.50                            | 3.8      | 16.0                             | 26.0                              |
| SL1050-2R2M | 2.20                            | 6        | 14.0                             | 20.0                              |
| SL1050-3R3M | 3.30                            | 7.5      | 12.0                             | 17.0                              |
| SL1050-4R7M | 4.70                            | 15       | 10.0                             | 15.0                              |
| SL1050-5R6M | 4.70                            | 17       | 9.5                              | 14.0                              |
| SL1050-6R8M | 6.80                            | 19.5     | 9.0                              | 13.0                              |
| SL1050-8R2M | 8.20                            | 28       | 8.5                              | 11.5                              |
| SL1050-100M | 10.00                           | 35       | 8.0                              | 10.0                              |
| SL1050-150M | 15.00                           | 48       | 6.5                              | 9.0                               |
| SL1050-220M | 22.00                           | 87       | 5.5                              | 8.0                               |
| SL1050-330M | 33.00                           | 95       | 5.0                              | 6.0                               |
| SL1050-470M | 47.00                           | 120      | 4.0                              | 5.0                               |
| SL1050-680M | 68.00                           | 170      | 3.5                              | 4.5                               |
| SL1050-101M | 100.00                          | 255      | 2.5                              | 3.5                               |

- ⊙ All test Data is referenced to 25°C ambient
- ⊙ Typical Heat Rating DC Current would cause an approximately ΔT of 40°C
- ⊙ Typical Saturation DC Current would cause L<sub>0</sub> to drop approximately 30%
- ⊙ Operation Temperature Range : -40°C ~ 125°C
- ⊙ The Part temperature (ambient + ΔT) should not exceed 125°C under worst case operating conditions.
- ⊙ Circuit design, component placement, PWB trace size and thickness, airflow and other cooling provisions all effect the part temperature. Part temperature should be verified in the end application.

# SPECIFICATION

RoHS  
COMPLIANT

|                 |                           |
|-----------------|---------------------------|
| <b>ITEM P/N</b> | <b>SL0420~1265-SERIES</b> |
| <b>PRODUCT</b>  | <b>SMD Inductor</b>       |

### PACKING DIMENSIONS (mm)

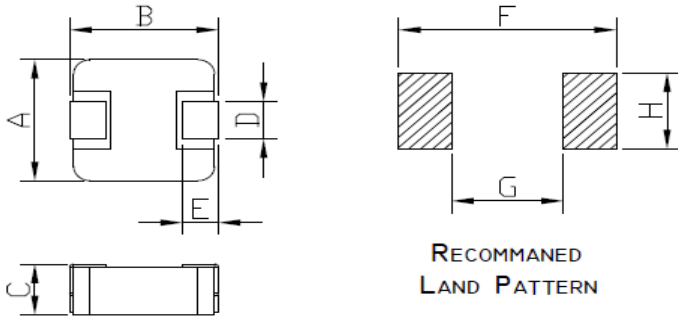

| 1250 | Dimensions |
|------|------------|
| A    | 12.8 ± 0.5 |
| B    | 13.5 ± 0.5 |
| C    | 5.0 MAX    |
| D    | 3.5 ± 0.5  |
| E    | 2.5 ± 0.5  |
| F    | 14.5 Typ   |
| G    | 8.00 Typ   |
| H    | 4.50 Typ   |

### EXPLANATION OF PART NUMBERS

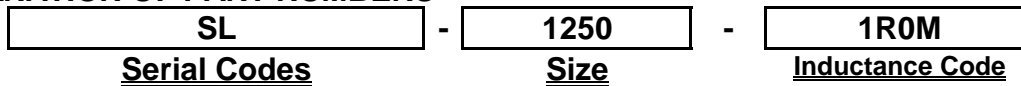

### ELECTRICAL CHARACTERISTICS

| P/N         | L0 Inductance<br>μH ±20%<br>@0A | DCR (mΩ) | Heat Rating Current              | Saturation Current                |
|-------------|---------------------------------|----------|----------------------------------|-----------------------------------|
|             |                                 | [ Max ]  | I <sub>dc</sub> (AMP)<br>Typical | I <sub>sat</sub> (AMP)<br>Typical |
| SL1250-R82M | 0.82                            | 1.7      | 30.0                             | 40.0                              |
| SL1250-1R0M | 1.00                            | 2.5      | 26.0                             | 35.0                              |
| SL1250-1R5M | 1.50                            | 4        | 23.0                             | 33.0                              |
| SL1250-2R2M | 2.20                            | 5.5      | 15.0                             | 26.0                              |
| SL1250-3R3M | 3.30                            | 7.5      | 14.0                             | 24.0                              |
| SL1250-4R7M | 4.70                            | 9        | 13.0                             | 20.0                              |
| SL1250-5R6M | 5.60                            | 10.5     | 12.0                             | 18.0                              |
| SL1250-6R8M | 6.80                            | 16.5     | 11.0                             | 15.0                              |
| SL1250-8R2M | 8.20                            | 22       | 9.0                              | 12.5                              |
| SL1250-100M | 10.00                           | 26.5     | 8.5                              | 12.0                              |
| SL1250-150M | 15.00                           | 33       | 8.0                              | 11.0                              |
| SL1250-220M | 22.00                           | 45       | 7.0                              | 8.0                               |
| SL1250-330M | 33.00                           | 68       | 5.0                              | 6.0                               |

- ⊙ All test Data is referenced to 25°C ambient
- ⊙ Typical Heat Rating DC Current would cause an approximately ΔT of 40°C
- ⊙ Typical Saturation DC Current would cause L<sub>0</sub> to drop approximately 30%
- ⊙ Operation Temperature Range : -40°C ~ 125°C
- ⊙ The Part temperature (ambient + ΔT) should not exceed 125°C under worst case operating conditions.
- ⊙ Circuit design, component placement, PWB trace size and thickness, airflow and other cooling provisions all effect the part temperature. Part temperature should be verified in the end application.

# SPECIFICATION

RoHS  
COMPLIANT

|                 |                           |
|-----------------|---------------------------|
| <b>ITEM P/N</b> | <b>SL0420~1265-SERIES</b> |
| <b>PRODUCT</b>  | <b>SMD Inductor</b>       |

## PACKING DIMENSIONS (mm)

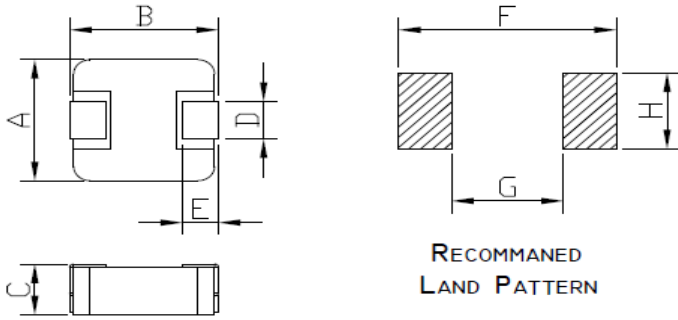

| 1265 | Dimensions |
|------|------------|
| A    | 12.8 ± 0.5 |
| B    | 13.5 ± 0.5 |
| C    | 6.5 MAX    |
| D    | 3.5 ± 0.5  |
| E    | 2.5 ± 0.5  |
| F    | 14.5 Typ   |
| G    | 8.00 Typ   |
| H    | 4.50 Typ   |

## EXPLANATION OF PART NUMBERS

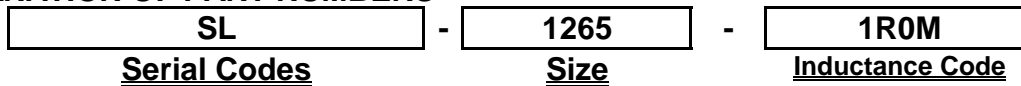

## ELECTRICAL CHARACTERISTICS

| P/N         | L0 Inductance<br>μH ±20%<br>@0A | DCR (mΩ) | Heat Rating Current              | Saturation Current                |
|-------------|---------------------------------|----------|----------------------------------|-----------------------------------|
|             |                                 | [ Max ]  | I <sub>dc</sub> (AMP)<br>Typical | I <sub>sat</sub> (AMP)<br>Typical |
| SL1265-1R0M | 1.00                            | 1        | 24.0                             | 40.0                              |
| SL1265-1R5M | 1.50                            | 1.8      | 23.0                             | 30.0                              |
| SL1265-2R2M | 2.20                            | 3.2      | 21.0                             | 27.0                              |
| SL1265-3R3M | 3.30                            | 6.5      | 15.0                             | 24.0                              |
| SL1265-4R7M | 4.70                            | 7.5      | 15.0                             | 22.0                              |
| SL1265-5R6M | 5.60                            | 10.5     | 13.0                             | 21.0                              |
| SL1265-6R8M | 6.80                            | 13.5     | 12.0                             | 19.0                              |
| SL1265-8R2M | 8.20                            | 16       | 11.0                             | 15.5                              |
| SL1265-100M | 10.00                           | 18       | 10.0                             | 15.0                              |
| SL1265-150M | 15.00                           | 26       | 8.5                              | 13.5                              |
| SL1265-220M | 22.00                           | 39.5     | 7.0                              | 10.0                              |
| SL1265-330M | 33.00                           | 53       | 6.0                              | 8.0                               |
| SL1265-470M | 47.00                           | 75       | 5.5                              | 6.5                               |
| SL1265-680M | 68.00                           | 115      | 3.5                              | 4.5                               |
| SL1265-101M | 100.00                          | 138      | 2.0                              | 3.5                               |

- ⊙ All test Data is referenced to 25°C ambient
- ⊙ Typical Heat Rating DC Current would cause an approximately ΔT of 40°C
- ⊙ Typical Saturation DC Current would cause L<sub>0</sub> to drop approximately 30%
- ⊙ Operation Temperature Range : -40°C ~ 125°C
- ⊙ The Part temperature (ambient + ΔT) should not exceed 125°C under worst case operating conditions.
- ⊙ Circuit design, component placement, PWB trace size and thickness, airflow and other cooling provisions all effect the part temperature. Part temperature should be verified in the end application.

# CHARACTERISTICS

RoHS  
COMPLIANT

|          |                    |
|----------|--------------------|
| ITEM P/N | SL0420~1265-SERIES |
| PRODUCT  | SMD Inductor       |

## RECOMMENDED SOLDERING TEMP. GRAPH

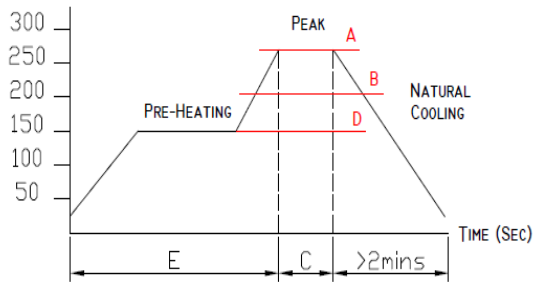

|   |            |
|---|------------|
| A | 260°C      |
| B | 230°C      |
| C | 10 Sec     |
| D | 150°C      |
| E | 60~240 Sec |

## MECHANICAL RELIABILITY

| TEST          | Specification & Requirement  | Method Used   |
|---------------|--|---|
| Solderability | The surface of terminal/pin tested shall be covered with new solder by 95% | Solder heat proof:<br>Preheating: 180 ±10°C 90 seconds<br>Soldering: 255 ±5°C for 3 ±1 sec                              |
| Shock         | Inductance change within ± 5% Without mechanical damage                    | Drop down with 981m/s <sup>2</sup> (100G) shock<br>Attitude upon a rubber block method shock testing machinem, 3 tests. |
| Vibration     | Inductance change within ± 5% Without mechanical damage                    | Vibration frequency:<br>10Hz to 55Hz to 10Hz 60 seconds cycle<br>Vibration time: 2 hours                                |

## ENDURANCE RELIABILITY

| TEST                | Specification & Requirement                             | Method Used  |
|---------------------|---|--|
| Thermal Shock       | Inductance change within ± 5% Without mechanical damage | -25°C, (30 mins) -> room temp. (5 mins) -> 125°C, (30 mins) -> room temp. (5 mins)<br>100 cycles |
| Heat Resistance     | Inductance change within ± 5% Without mechanical damage | Apply IDC current @ 85°C ambient<br>Duration: 1000 hrs   |
| Humidity Resistance | Inductance change within ± 5% Without mechanical damage | Apply IDC current @ 60°C ambient<br>Humidity: 90~95%<br>Duration: 1000 hrs                       |
| Low Temp. Storing   | Inductance change within ± 5% Without mechanical damage | Storing Temp.<br>-25 ±2 °C for total 1,000 +4/-0 hours   |
| High Temp. Storing  | Inductance change within ± 5% Without mechanical damage | Storing Temp.<br>125 ±2 °C for total 1,000 +4/-0 hours   |

# PACKING FOR SMD

RoHS  
COMPLIANT

ITEM P/N

SL0420~1265-SERIES

PRODUCT

SMD Inductor

## CARRIERTAPEING REEL & CARRIER MATERIALS (PAPER PLASTICS) UNIT : (mm)

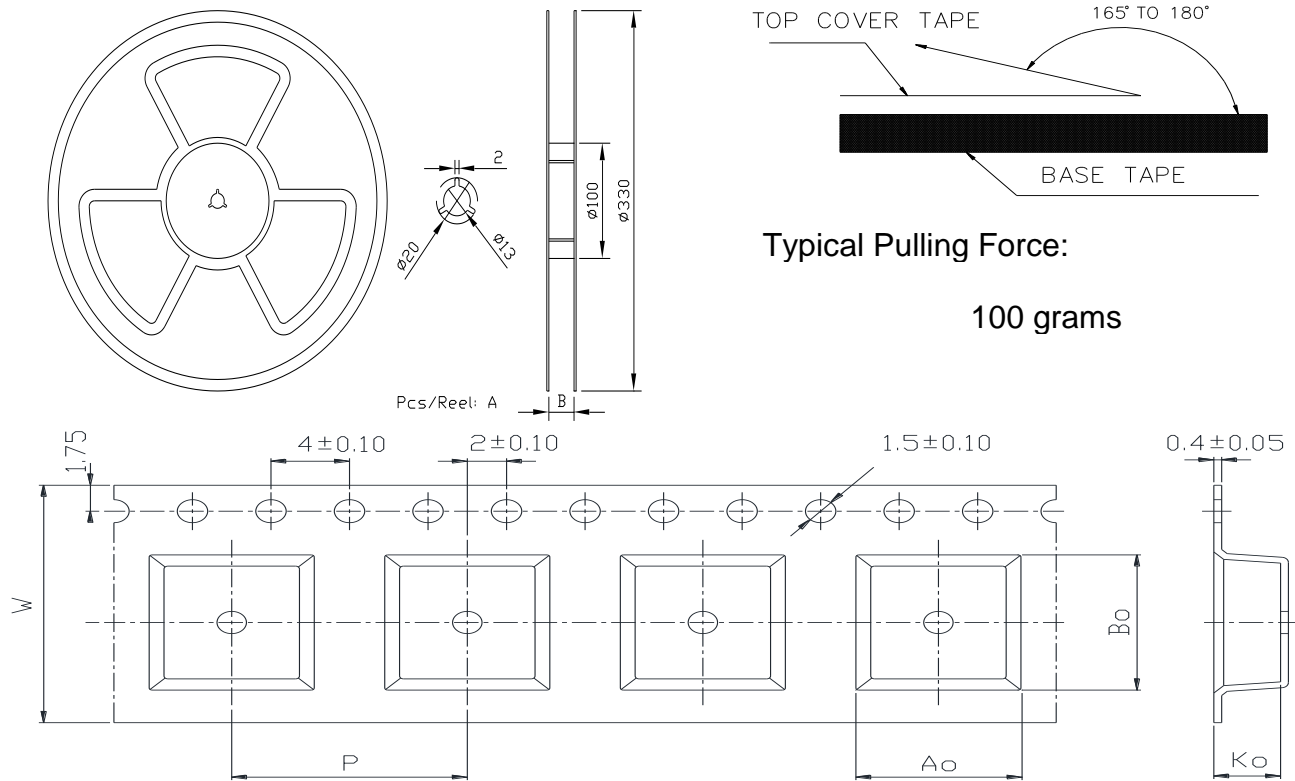

Typical Pulling Force:

100 grams

| Series | A    | B    | W  | Ao      | Bo       | Ko     |
|--------|------|------|----|---------|----------|--------|
| 0420   | 3000 | 12   | 12 | 4.6Typ  | 4.75 Typ | 2.3Typ |
| 0520   | 2000 | 12.5 | 12 | 5.7Typ  | 5.90 Typ | 2.3Typ |
| 0530   | 2000 | 12.5 | 12 | 5.7Typ  | 5.90 Typ | 3.6Typ |
| 0620   | 2000 | 17   | 16 | 6.9Typ  | 7.6 Typ  | 2.3Typ |
| 0624   | 1000 | 17   | 16 | 6.9Typ  | 7.6 Typ  | 2.3Typ |
| 0630   | 1000 | 17   | 16 | 6.9Typ  | 7.6 Typ  | 3.3Typ |
| 0650   | 1000 | 17   | 16 | 6.9Typ  | 7.6 Typ  | 5.4Typ |
| 1040   | 800  | 25   | 24 | 11.0Typ | 12.6 Typ | 4.3Typ |
| 1050   | 800  | 25   | 24 | 11.0Typ | 12.6 Typ | 5.4Typ |
| 1250   | 500  | 25   | 24 | 13.1Typ | 15.0 Typ | 5.3Typ |
| 1265   | 500  | 25   | 24 | 13.1Typ | 15.0 Typ | 6.8Typ |

## X-ON Electronics

Largest Supplier of Electrical and Electronic Components

*Click to view similar products for [Fixed Inductors](#) category:*

*Click to view products by [TECHFUSE](#) manufacturer:*

Other Similar products are found below :

[CR32NP-100KC](#) [70F224AI](#) [MHQ1005P10NJ](#) [MHQ1005P1N0S](#) [MHQ1005P2N4S](#) [MHQ1005P3N6S](#) [MHQ1005P5N1S](#) [MHQ1005P8N2J](#)  
[PE-53601NL](#) [PE-53602NL](#) [PG0936.113NLT](#) [9220-20](#) [9310-16](#) [PM06-2N7](#) [PM06-39NJ](#) [A01TK](#) [1206CS-471XJ](#) [HC2-R47-R](#) [HC8-1R2-R](#)  
[HCF1305-3R3-R](#) [1206CS-151XG](#) [RCH664NP-4R7M](#) [RCP1317NP-391L](#) [DH2280-4R7M](#) [DS1608C-106](#) [B10TJ](#) [B82498B3101J000](#) [ELJ-](#)  
[RE27NJF2](#) [1812CS-153XJ](#) [1812CS-183XJ](#) [1812CS-223XJ](#) [1812LS-104XJ](#) [1812LS-105XJ](#) [1812LS-124XJ](#) [1812LS-154XJ](#) [1812LS-223XJ](#)  
[1812LS-224XJ](#) [1812LS-563XJ](#) [1812LS-683XJ](#) [1812LS-824XJ](#) [NIN-FB101JTR110F](#) [NIN-FB471JTR62F](#) [NIN-FC1R5JTR220F](#) [NIN-](#)  
[HCR15JTRF](#) [NIN-HCR33JTRF](#) [NIN-HDR22JTRF](#) [NIN-HDR82JTRF](#) [NIN-HK2N7STRF](#) [NIN-PA150KTR370F](#) [NIN-PB100KTR550F](#)