



SEA & LAND ELECTRONIC CORP.

[www.sealand-pptc.com](http://www.sealand-pptc.com)



ALPHA-TOP TECHNOLOGY CORP.

[www.alpha-top.cn](http://www.alpha-top.cn)

## APPROVAL SHEET

MODEL NO.: SMD0603-035-12V

CUSTOMER:

CUSTOMER'S APPROVAL:

AUTHORIZED SIGNATURE/STAMP:

DATE

MANUFACTURER:

HEAD OFFICE:

13F.,No.120-10,Sec.3,Zhongshan Rd.,Zhonghe Dist.,New Taipei City 23544,Taiwan  
Tel: 886-2-8221-2567  
Fax:882-2-2225-7268  
E-mail:service@chipfast.com.tw

China Branch:

Factory Building B)Shuangpeng,Weibu Village, Qiuchang Town,  
Huiyang District, Huizhou City, Guangdong Province, P.R.C.)  
Tel: 86-752-3562001  
Fax:86-752-3558696  
E-mail:service@atpptc.com

Submitted by: Chen  
Approved by: YC Lin  
DATE: 17-May-24

SEA & LAND ELECTRONIC CORP.

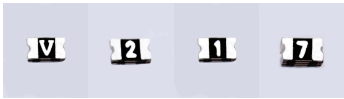

**Features**

- Surface Mount Devices
- Lead free device
- Size 1.5\*0.8 mm / 0.06\*0.03 inch
- Surface Mount packaging for automated assembly

**Applications**

- Almost anywhere there is a low voltage power supply, up to 15V and a load to be protected, including:
- Computer mother board, Modem, USB hub
  - PDAs & Charger, Analog & digital line card
  - Digital cameras, Disk drivers, CD-ROMs,

**SMD0603-035-12V**

Alpha-Top (Sea & Land Alliance)

**Performance Specification**

Model	Marking	V <sub>max</sub> (Vdc)	I <sub>max</sub> (A)	I <sub>hold</sub> @25°C (A)	I <sub>trip</sub> @25°C (A)	P <sub>d</sub> Typ. (W)	Maximum Time To Trip		Resistance		Agency Approval	
							Current (A)	Time (Sec)	R <sub>i min</sub> (Ω)	R <sub>1max</sub> (Ω)	UL	TUV
SMD0603-035-12V	3	12	40	0.35	0.75	0.5	8.0	0.10	0.200	1.400		

**I<sub>hold</sub>** = Hold Current. Maximum current device will not trip in 25°C still air.  
**I<sub>trip</sub>** = Trip Current. Minimum current at which the device will always trip in 25°C still air.  
**V<sub>max</sub>** = Maximum operating voltage device can withstand without damage at rated current (I<sub>max</sub>).  
**I<sub>max</sub>** = Maximum fault current device can withstand without damage at rated voltage (V<sub>max</sub>).  
**P<sub>d</sub>** = Power dissipation when device is in the tripped state in 25°C still air environment at rated voltage.  
**R<sub>imin/max</sub>** = Minimum/Maximum device resistance prior to tripping at 25°C.  
**R<sub>1max</sub>** = Maximum device resistance is measured one hour post reflow.  
**CAUTION** : Operation beyond the specified ratings may result in damage and possible arcing and flame.

**Environmental Specifications**

Test	Conditions
Passive aging	+85°C, 1000 hrs.
Humidity aging	+85°C, 85% R.H. , 168 hours
Thermal shock	+85°C to -40°C, 20 times
Resistance to solvent	MIL-STD-202, Method 215
Vibration	MIL-STD-202, Method 201
Ambient operating conditions : - 40 °C to +85 °C	
Maximum surface temperature of the device in the tripped state is 125 °C	
In case of special use, please contact our engineer	

**Agency Approvals :**

**Regulation/Standard:**

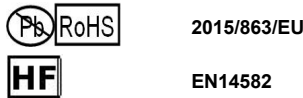

**I<sub>hold</sub> Versus Temperature**

Model	Maximum ambient operating temperature (T <sub>mao</sub> ) vs. hold current (I <sub>hold</sub> )								
	-40°C	-20°C	0°C	25°C	40°C	50°C	60°C	70°C	85°C
SMD0603-035-12V	0.47	0.41	0.38	0.35	0.29	0.26	0.24	0.20	0.14

### Construction And Dimension (Unit:mm)

Model	A		B		C		D		E
	Min.	Max.	Min.	Max.	Min.	Max.	Min.	Max.	Min.
SMD0603-035-12V	1.45	1.85	0.65	1.05	0.40	1.00	0.15	0.10	

### Dimensions & Marking

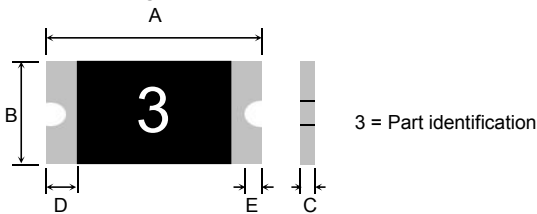

### Recommended Pad Layout (mm)

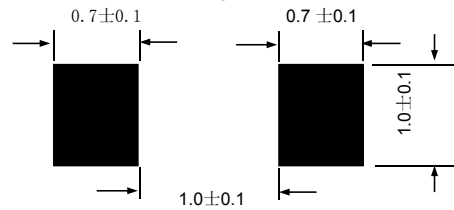

### Termination Pad Characteristics

Terminal pad materials : Tin-plated Nickel-Copper  
 Terminal pad solderability : Meets EIA specification RS186-9E and ANSI/J-STD-002 Category 3.

### Rework

Use standard industry practices, the removal device must be replaced with a fresh one.

### Thermal Derating Curve

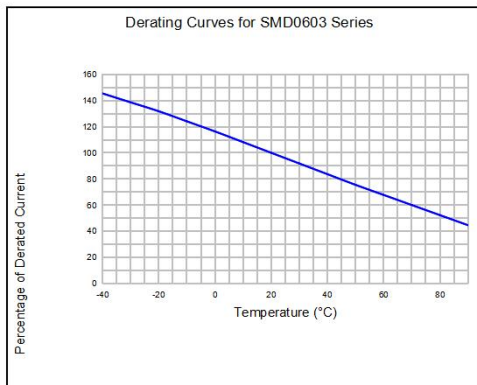

### Typical Time-To-Trip At 25°C

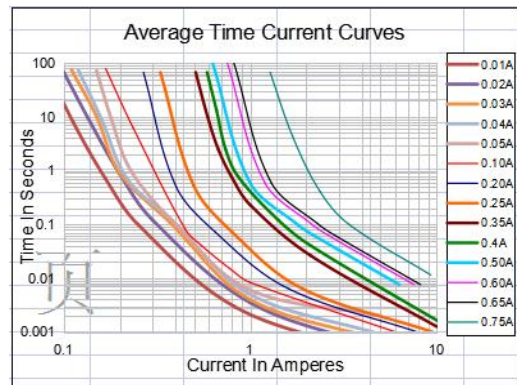

### WARNING:

- Use PPTC beyond the maximum ratings or improper use may result in device damage and possible electrical arcing and flame.
- PPTC are intended for protection against occasional over current or over temperature fault conditions and should not be used when repeated fault conditions or prolonged trip events are anticipated.
- Device performance can be impacted negatively if devices are handled in a manner inconsistent with recommended electronic, thermal, and mechanical procedures for electronic components.
- Use PPTC with a large inductance in circuit will generate a circuit voltage (L di/dt) above the rated voltage of the PPTC.
- Avoid impact PPTC device its thermal expansion like placed under pressure or installed in limited space.
- Contamination of the PPTC material with certain silicon based oils or some aggressive solvents can adversely impact the performance of the devices. PPTC SMD can be cleaned by standard methods.
- Requests that customers comply with our recommended solder pad layouts and recommended reflow profile. Improper board layouts or reflow profile could negatively impact solderability performance of our devices.

### Recommended Solder Reflow Conditions

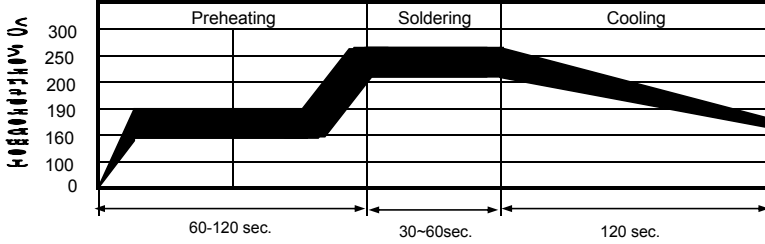

- Recommended reflow methods : IR, vapor phase oven, hot air oven.
  - Devices are not designed to be wave soldered to the bottom side of the board.
  - Recommended maximum paste thickness is 0.25 mm (0.010 inch).
  - Devices can be cleaned using standard method and solvents.
- Note : If reflow temperatures exceed the recommended profile, devices may not meet the performance requirements.

### Tape And Reel Specifications (mm)

Governing Specifications	
W	8.0 ± 0.2
P <sub>0</sub>	4.0 ± 0.10
P <sub>1</sub>	4.0 ± 0.10
P <sub>2</sub>	2.0 ± 0.05
A <sub>0</sub>	1.05 ± 0.10
B <sub>0</sub>	1.85 ± 0.10
D <sub>0</sub>	1.55 + 0.05
F	3.5 ± 0.05
E <sub>1</sub>	1.75 ± 0.10
E <sub>2</sub> min.	6.25
T	0.75
T <sub>1</sub> max.	0.1
K <sub>0</sub>	0.75/0.95 ± 0.1
Leader min.	390
Trailer min.	160
Reel Dimensions	
A max.	178
N min.	60
W <sub>1</sub>	9.0 ± 0.5
W <sub>2</sub>	12.0 ± 0.05

### Paper Tape Component Dimensions

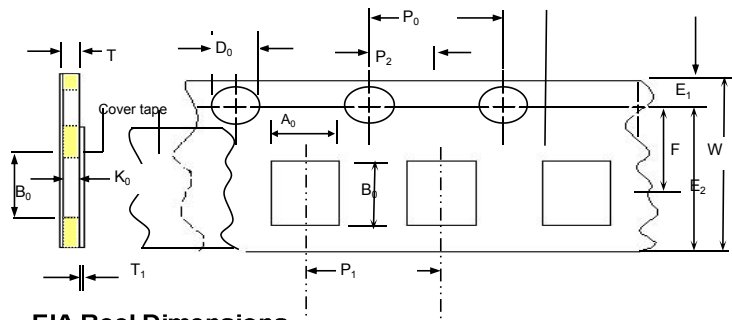

### EIA Reel Dimensions

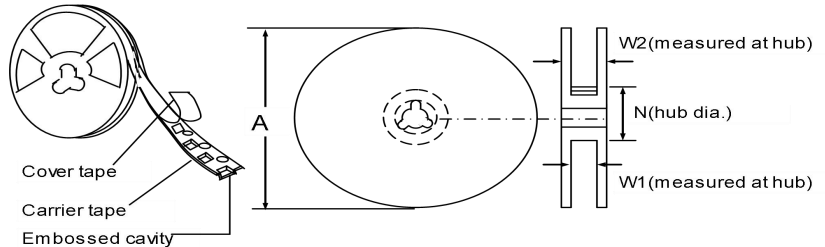

### Storage And Handling

- Storage conditions : 40°C max, 70% R.H.
- Devices may not meet specified performance if storage conditions are exceeded.

### Order Information

SMD0603	035-12V	Packaging	Tape & Reel Quantity
Product name	Hold		
Size 1508 mm / 0603 inch	Current		5,000 pcs/reel
SMD: surface mount device	0.35A		

Tape & reel packaging per EIA481-1 Labeling Information

**Sea & Land Electronic Corp.**

HF   Pb   RoHS

Model:  
Part no.:  
Spec.:  
Lot no.:  
Q'ty:

倉儲：密封！溫度：18~33°C/濕度：30~60% A

## X-ON Electronics

Largest Supplier of Electrical and Electronic Components

*Click to view similar products for [Resettable Fuses - PPTC](#) category:*

*Click to view products by [TECHFUSE](#) manufacturer:*

Other Similar products are found below :

[RF0077-000](#) [RF0627-000](#) [RF3301-000](#) [RF3382-000](#) [RF3394-000](#) [RF3399-000](#) [SMD125-2](#) [RF1973-000](#) [RF2531-000](#) [RF2873-000](#) [RF3060-000](#) [RF3311-000](#) [TR600-150Q-B-0.5-0.130](#) [RXE090](#) [5E4795/04-1502](#) [TRF250-080T-B-1.0-0.125](#) [SMD100-2](#) [NIS5431MT1TXG](#) [SMD250-2](#) [RS30-090](#) [RS30-600](#) [RS30-800](#) [RS30-900](#) [RS60RB-160](#) [RS60SB-250](#) [SB250-145](#) [K30U400](#) [0ZCH0110AF2E](#) [BK60-110-DI-E0.6](#) [BK250-120-SZ-E0.6](#) [BK60-010-DI-E0.5](#) [BK250-040-DY-E0.6](#) [RF2631-000](#) [NIS4461MT3TXG](#) [NIS5420MT2TXG](#) [NIS5420MT3TXG](#) [NIS6420MT1TWG](#) [RF5032-000](#) [RF5051-000](#) [RF5105-000](#) [RF5062-000](#) [RF5055-000](#) [RF5052-000](#) [2920L075/72MR](#) [BSMD0603-025-24V](#) [BSMD0402L-005](#) [BSMD0603-010-9V](#) [BSMD1812-020-60V](#) [BSMD2920-400-30V](#) [BSMD0603-010-12V](#)