

Features

- Operation voltage range: 1.65~5.5V
- 5V Tolerant Input/Output for Interfacing with 5V logic
- $\pm 24\text{mA}$ Output Drive ($V_{CC} = 3.3\text{V}$)
- CMOS Low-Power Consumption and High Noise Immunity
- ESD Protection Exceeds JESD 22
 - 2000-V Human-Body Model (A114-A)
 - 1000-V Charged-Device Model (C101)
- SOT23-6 Package Available
- SOT363 Package Available

Applications

- Voltage Level Shifting
- General Purpose Logic
- Power Down Signal Isolation
- Wide array of products such as:
 - PCs, Networking, Notebooks, Netbooks, PDAs
 - Tablet Computers, E-readers
 - Computer Peripherals, Hard Drives, CD/DVD ROM
 - TV, DVD, DVR, Set-Top Box
 - Cell Phones, Personal Navigation / GPS
 - MP3 Players, Cameras, Video Recorders

General Description

The 74LVC2G14 is a dual inverter gate and it provides the Boolean function $Y = \overline{A}$ in positive logic.

This device has power-down protective circuit to prevent the device from destruction when it is powered down.

Ordering Information

ORDER NUMBER	PACKAGE DESCRIPTION	PACKAGE OPTION
74LVC2G14GV	SOT23-6	Tape and Reel,3000
74LVC2G14GW	SOT363	Tape and Reel,3000

Logic Diagram

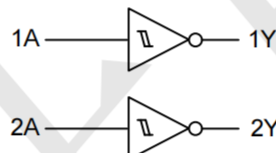
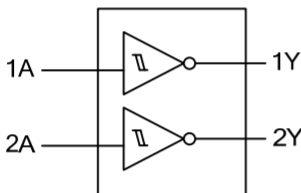

Pin Configuration

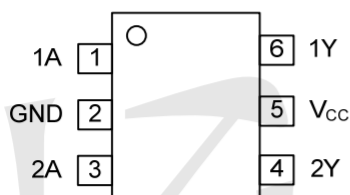

Marking

74LVC2G14GV Marking:V14

74LVC2G14GW Marking:VK

Function Table

INPUT(A)	OUTPUT(Y)
L	H
H	L

H=High level
L=Low Level



Absolute Maximum Ratings

PARAMETER		SYMBOL	RATINGS	UNIT
Supply Voltage		V_{CC}	-0.5 ~ +6.5	V
Input Voltage		V_{IN}	-0.5 ~ +6.5	V
Output Voltage	High-impedance	V_{OUT}	-0.5 ~ 6.5	V
	Power-off			
	High State		-0.5 ~ $V_{CC}+0.5$	V
	Low State			
V_{CC} or GND Current		I_{CC}	±100	mA
Continuous Output Current		I_O	±50	mA
Input Clamp Current		I_{IK}	-50	mA
Output Clamp Current		I_{OK}	-50	mA
Storage Temperature		T_{STG}	-65 ~ +150	°C

Note: Absolute maximum ratings are those values beyond which the device could be permanently damaged. Absolute maximum ratings are stress ratings only and functional device operation is not implied.

THERMAL DATA

PARAMETER		SYMBOL	RATINGS	UNIT
Junction to Ambient	SOT-363	θ_{JA}	350	°C/W
	SOT-23-6		230	°C/W

Recommended Operating Conditions

PARAMETER	SYMBOL	TEST CONDITIONS	MIN	TYP	MAX	UNIT
Supply Voltage	V_{CC}		1.65		5.5	V
Control Input Voltage	V_{IN}		0		5.5	V
Output Voltage	V_{OUT}	High or low state	0		V_{CC}	V
High Level Output Current	I_{OH}	$V_{CC} = 1.65V$			-4	mA
		$V_{CC} = 2.3V$			-8	mA
		$V_{CC} = 3V$			-16	mA
		$V_{CC} = 3V$			-24	mA
		$V_{CC} = 4.5V$			-32	mA
Low Level Output Current	I_{OL}	$V_{CC} = 1.65V$			4	mA
		$V_{CC} = 2.3V$			8	mA
		$V_{CC} = 3V$			16	mA
		$V_{CC} = 3V$			24	mA
		$V_{CC} = 4.5V$			32	mA
Operating Temperature	T_A		-40		+125	°C

Electrical Characteristics ($T_A = 25^\circ\text{C}$, unless otherwise specified)

PARAMETER	SYMBOL	TEST CONDITIONS	$T_A = 25^\circ\text{C}$			$T_A = -40 \sim +125^\circ\text{C}$			UNIT
			MIN	TYP	MAX	MIN	TYP	MAX	
Positive-Going Input Threshold Voltage	V_{T+}	$V_{CC} = 1.65\text{V}$	0.7	1.24	1.5	0.7		1.7	V
		$V_{CC} = 2.3\text{V}$	1.0	1.54	1.8	1.0		2.0	V
		$V_{CC} = 3\text{V}$	1.3	1.86	2.2	1.3		2.4	V
		$V_{CC} = 4.5\text{V}$	1.9	2.59	3.1	1.9		3.3	V
		$V_{CC} = 5.5\text{V}$	2.2	3.08	3.7	2.2		3.8	V
Negative-Going Input Threshold Voltage	V_{T-}	$V_{CC} = 1.65\text{V}$	0.25	0.61	0.9	0.25		1.1	V
		$V_{CC} = 2.3\text{V}$	0.4	0.82	1.15	0.4		1.35	V
		$V_{CC} = 3\text{V}$	0.6	1.15	1.5	0.6		1.7	V
		$V_{CC} = 4.5\text{V}$	1.0	1.73	2.0	1.0		2.2	V
		$V_{CC} = 5.5\text{V}$	1.2	2.13	2.5	1.2		2.5	V
Hysteresis Voltage ($V_{T+} - V_{T-}$)	ΔV_T	$V_{CC} = 1.65\text{V}$	0.15	0.67	1.0	0.15		1.2	V
		$V_{CC} = 2.3\text{V}$	0.25	0.72	1.1	0.25		1.3	V
		$V_{CC} = 3\text{V}$	0.4	0.73	1.2	0.4		1.4	V
		$V_{CC} = 4.5\text{V}$	0.6	0.92	1.5	0.6		1.7	V
		$V_{CC} = 5.5\text{V}$	0.7	1.02	1.7	0.7		1.9	V
High-Level Output Voltage	V_{OH}	$V_{CC} = 1.65 \sim 5.5\text{V}$, $I_{OH} = -100\mu\text{A}$	$V_{CC} - 0.1$			$V_{CC} - 0.1$			V
		$V_{CC} = 1.65\text{V}$, $I_{OH} = -4\text{mA}$	1.20			0.95			V
		$V_{CC} = 2.3\text{V}$, $I_{OH} = -8\text{mA}$	1.90			1.7			V
		$V_{CC} = 3\text{V}$, $I_{OH} = -16\text{mA}$	2.20			1.9			V
		$V_{CC} = 3\text{V}$, $I_{OH} = -24\text{mA}$	2.30			2.0			V
		$V_{CC} = 4.5\text{V}$, $I_{OH} = -32\text{mA}$	3.80			3.4			V
Low-Level Output Voltage	V_{OL}	$V_{CC} = 1.65 \sim 5.5\text{V}$, $I_{OL} = 100\mu\text{A}$			0.10			0.1	V
		$V_{CC} = 1.65\text{V}$, $I_{OL} = 4\text{mA}$			0.45			0.7	V
		$V_{CC} = 2.3\text{V}$, $I_{OL} = 8\text{mA}$			0.30			0.45	V
		$V_{CC} = 3\text{V}$, $I_{OL} = 16\text{mA}$			0.40			0.6	V
		$V_{CC} = 3\text{V}$, $I_{OL} = 24\text{mA}$			0.55			0.8	V
		$V_{CC} = 4.5\text{V}$, $I_{OL} = 32\text{mA}$			0.55			0.8	V
Input Leakage Current	$I_{I(\text{LEAK})}$	$V_{CC} = 0\text{V to } 5.5\text{V}$, $V_{IN} = 0$ or 5.5V			± 5			± 5	μA
Power OFF Leakage Current	I_{OFF}	$V_{CC} = 0\text{V}$, V_{IN} or $V_{OUT} = 5.5\text{V}$,			± 10			± 10	μA
Quiescent Supply Current	I_Q	$V_{CC} = 1.65\text{V to } 5.5\text{V}$, $I_{OUT} = 0$, $V_{IN} = 5.5\text{V}$ or GND		0.1	10			10	μA
Additional Quiescent Supply Current Per Pin	ΔI_Q	$V_{CC} = 3\text{V to } 5.5\text{V}$ One input at $V_{CC} - 0.6\text{V}$, Other inputs at V_{CC} or GND, $I_{OUT} = 0$			500			500	μA

Switching Characteristics (T_A =25°C , unless otherwise specified)

(see TEST CIRCUIT AND WAVEFORMS)

PARAMETER	SYMBOL	TEST CONDITIONS	T _A =25°C			T _A =-40~+125°C			UNIT
			MIN	TYP	MAX	MIN	TYP	MAX	
Propagation Delay from Input (nA) to Output(nY)	t _{PLH} / t _{PHL}	V _{CC} =1.8V±0.15V, V _{IN} =V _{CC} C _L =30pF, R _L =1KΩ	3.9		13	1.0		15	ns
		V _{CC} =2.5V±0.2V, V _{IN} =V _{CC} C _L =30pF, R _L =500Ω	1.9		6.5	1.0		8.5	ns
		V _{CC} =3.3V±0.3V, V _{IN} =3V C _L =50pF, R _L =500Ω	2.0		6.1	1.0		8.1	ns
		V _{CC} =5V±0.5V, V _{IN} =V _{CC} C _L =50pF, R _L =500Ω	1.5		5	0.5		6.0	ns

Operating Characteristics (Unless otherwise specified)

PARAMETER	SYMBOL	TEST CONDITIONS	MIN	TYP	MAX	UNIT
Input Capacitance	C _{IN}	V _{CC} =3.3V, V _{IN} =V _{CC} or GND		4		pF
Power Dissipation Capacitance	C _{PD}	V _{CC} =1.8V, f=10MHz		16		pF
		V _{CC} =2.5V, f=10MHz		17		pF
		V _{CC} =3.3V, f=10MHz		18		pF
		V _{CC} =5V, f=10MHz		21		pF



TEST CIRCUIT AND WAVEFORMS

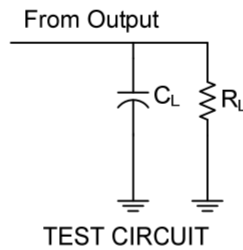

V_{CC}	Inputs		V_M	C_L	R_L
	V_{IN}	t_R, t_F			
$1.8V \pm 0.15V$	V_{CC}	$\leq 2ns$	$V_{CC}/2$	30pF	1k Ω
$2.5V \pm 0.2V$	V_{CC}	$\leq 2ns$	$V_{CC}/2$	30pF	500 Ω
$3.3V \pm 0.3V$	3V	$\leq 2.5ns$	1.5V	50pF	500 Ω
$5V \pm 0.5V$	V_{CC}	$\leq 2.5ns$	$V_{CC}/2$	50pF	500 Ω

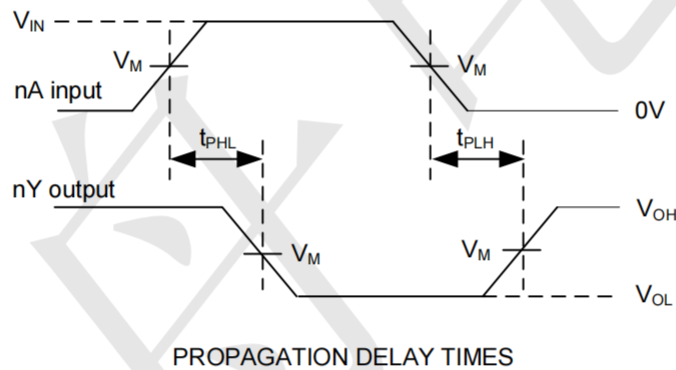

- Note: 1. C_L includes probe and jig capacitance.
 2. All input pulses are supplied by generators having the following characteristics:
 $PRR \leq 1MHz, Z_0 = 50\Omega: t_R \leq 2ns, t_F \leq 2ns$ ($V_{CC} = 1.8V \pm 0.15V$ and $V_{CC} = 2.5V \pm 0.2V$)
 $t_R \leq 2.5ns, t_F \leq 2.5ns$ ($V_{CC} = 3.3V \pm 0.3V$ and $V_{CC} = 5V \pm 0.5V$)



Package Outline Dimensions (Unit: mm)

SOT23-6

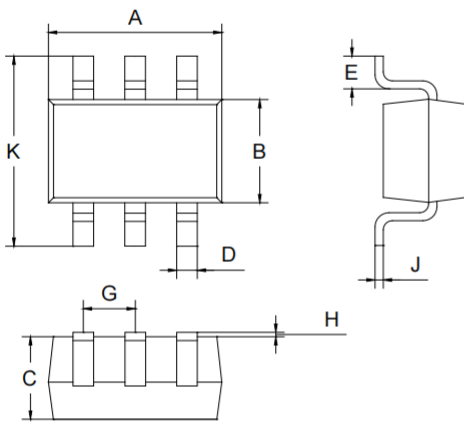

Dimension	Min.	Max.
A	2.80	3.00
B	1.50	1.70
C	1.00	1.20
D	0.35	0.45
E	0.35	0.55
G	0.90	1.00
H	0.02	0.10
J	0.10	0.20
K	2.60	3.00

Mounting Pad Layout (Unit: mm)

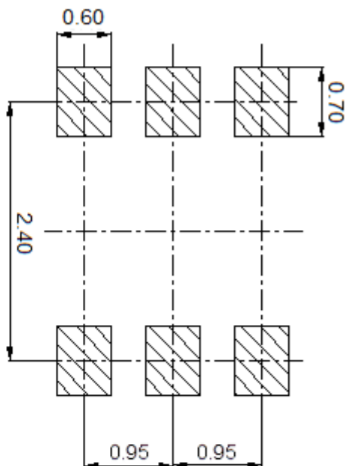



Package Outline Dimensions (Unit: mm)

SOT363

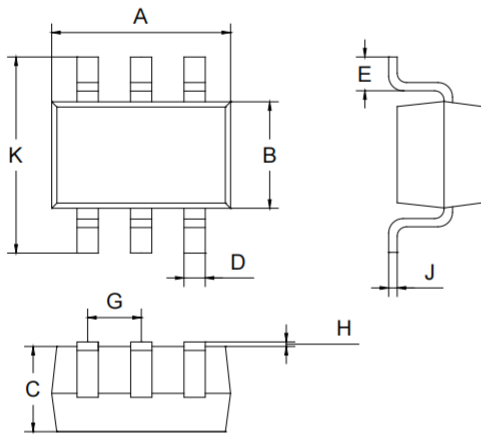

Dimension	Min.	Max.
A	2.00	2.20
B	1.15	1.35
C	0.85	1.05
D	0.15	0.35
E	0.25	0.40
G	0.60	0.70
H	0.02	0.10
J	0.05	0.15
K	2.20	2.40

Mounting Pad Layout (Unit: mm)

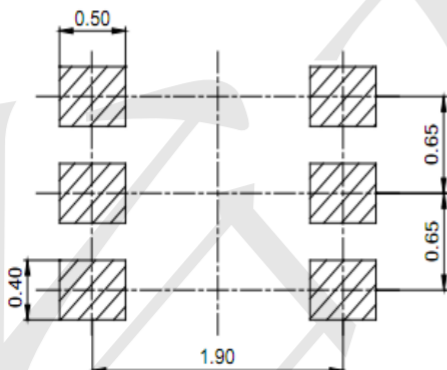

X-ON Electronics

Largest Supplier of Electrical and Electronic Components

Click to view similar products for [Buffers & Line Drivers](#) category:

Click to view products by [TECH PUBLIC](#) manufacturer:

Other Similar products are found below :

[LXV200-024SW](#) [74AUP2G34FW3-7](#) [HEF4043BP](#) [NL17SG125DFT2G](#) [NLU1GT126CMUTCG](#) [CD4041UBE](#) [54FCT240CTDB](#)
[74HCT540N](#) [DS14C88N](#) [070519XB](#) [NL17SZ07P5T5G](#) [74LVC2G17FW4-7](#) [CD4502BE](#) [5962-8982101PA](#) [61446R00](#) [NL17SH17P5T5G](#)
[NLV37WZ17USG](#) [74HCT126T14-13](#) [74VHC9126FT\(BJ\)](#) [RHRXH162244K1](#) [74AUP1G34FW5-7](#) [74AUP1G07FW5-7](#) [74LVC1G126FW4-7](#)
[74LVC2G126RA3-7](#) [74LVCE1G125FZ4-7](#) [54FCT240TLB](#) [NLX3G16DMUTCG](#) [NLX2G06AMUTCG](#) [LE87100NQCT](#) [LE87285NQC](#)
[LE87290YQC](#) [LE87290YQCT](#) [74AUP1G125FW5-7](#) [NLU2G16CMUTCG](#) [MC74LCX244MN2TWG](#) [NL17SG17P5T5G](#)
[NLV74HC125ADR2G](#) [NLVHCT245ADTR2G](#) [NLVVHC1G126DFT2G](#) [EL5623IRZ](#) [ISL15102AIRZ-T13](#) [ISL1539IRZ-T13](#)
[MC100EP17MNG](#) [MC74HCT365ADR2G](#) [MC74LCX244ADTR2G](#) [NL27WZ126US](#) [NL37WZ16US](#) [NLU1G07MUTCG](#) [NLU2G07MUTCG](#)
[NLX3G17BMX1TCG](#)