

**Product Summary**

- 20V, 3.5A,  $R_{DS(ON)} = 40m\Omega$  @ $V_{GS} = 4.5V$ .  
 $R_{DS(ON)} = 50m\Omega$  @ $V_{GS} = 2.5V$ .
- -20V, -2.8A,  $R_{DS(ON)} = 85m\Omega$  @ $V_{GS} = -4.5V$ .  
 $R_{DS(ON)} = 100m\Omega$  @ $V_{GS} = -2.5V$ .

**Application**

- DC-DC Converters.
- Load Switch.
- Power Management.

**Package and Pin Configuration**

SOT23-6 Or TSOP-6

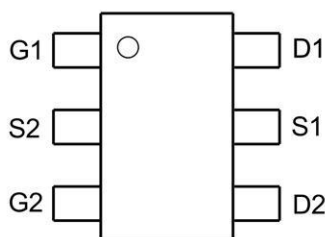

**Circuit diagram**

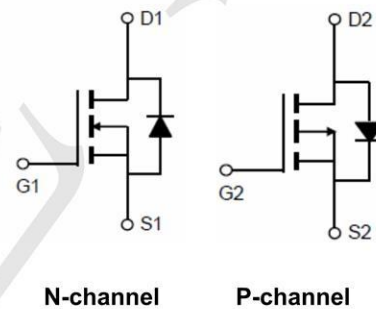

Marking:

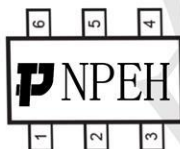

**Absolute Maximum Ratings ( $T_A=25^{\circ}C$  unless otherwise noted)**

Parameter	Symbol	N-Channel	P-Channel	Units
Drain-Source Voltage	$V_{DS}$	20	-20	V
Gate-Source Voltage	$V_{GS}$	$\pm 12$	$\pm 12$	V
Drain Current-Continuous	$I_D$	3.5	-2.8	A
Drain Current-Pulsed <sup>a</sup>	$I_{DM}$	14	10	A
Maximum Power Dissipation	$P_D$	1.14		W
Operating and Store Temperature Range	$T_J, T_{stg}$	-55 to 150		$^{\circ}C$

**Thermal Characteristic**

Parameter	Symbol	Limit	Units
Thermal Resistance, Junction-to-Ambient <sup>b</sup>	$R_{\theta JA}$	110	$^{\circ}C/W$

**N-CH Electrical Characteristics (T<sub>A</sub>=25°C unless otherwise noted)**

Parameter	Symbol	Test Condition	Min	Typ	Max	Units
<b>Off Characteristics</b>						
Drain-Source Breakdown Voltage	BV <sub>DSS</sub>	V <sub>GS</sub> = 0V, I <sub>D</sub> = 250μA	20			V
Zero Gate Voltage Drain Current	I <sub>DSS</sub>	V <sub>DS</sub> = 20V, V <sub>GS</sub> = 0V			1	μA
Gate Body Leakage Current, Forward	I <sub>GSSF</sub>	V <sub>GS</sub> = 12V, V <sub>DS</sub> = 0V			100	nA
Gate Body Leakage Current, Reverse	I <sub>GSSR</sub>	V <sub>GS</sub> = -12V, V <sub>DS</sub> = 0V			-100	nA
<b>On Characteristics<sup>c</sup></b>						
Gate Threshold Voltage	V <sub>GS(th)</sub>	V <sub>GS</sub> = V <sub>DS</sub> , I <sub>D</sub> = 250μA	0.4		1.2	V
Static Drain-Source On-Resistance	R <sub>DS(on)</sub>	V <sub>GS</sub> = 4.5V, I <sub>D</sub> = 3.5A		40	55	mΩ
		V <sub>GS</sub> = 2.5V, I <sub>D</sub> = 2.0A		50	80	mΩ
<b>Dynamic Characteristics<sup>d</sup></b>						
Input Capacitance	C <sub>iss</sub>	V <sub>DS</sub> = 10V, V <sub>GS</sub> = 0V, f = 1.0 MHz		380		pF
Output Capacitance	C <sub>oss</sub>			90		pF
Reverse Transfer Capacitance	C <sub>rss</sub>			60		pF
<b>Switching Characteristics<sup>d</sup></b>						
Turn-On Delay Time	t <sub>d(on)</sub>	V <sub>DD</sub> = 10V, I <sub>D</sub> = 3.5A, V <sub>GS</sub> = 4.5V, R <sub>GEN</sub> = 6Ω		16		ns
Turn-On Rise Time	t <sub>r</sub>			16		ns
Turn-Off Delay Time	t <sub>d(off)</sub>			32		ns
Turn-Off Fall Time	t <sub>f</sub>			7		ns
Total Gate Charge	Q <sub>g</sub>	V <sub>DS</sub> = 10V, I <sub>D</sub> = 3.5A, V <sub>GS</sub> = 3.3V		3.6		nC
Gate-Source Charge	Q <sub>gs</sub>			1.0		nC
Gate-Drain Charge	Q <sub>gd</sub>			1.2		nC
<b>Drain-Source Diode Characteristics and Maximum Ratings</b>						
Drain-Source Diode Forward Current <sup>b</sup>	I <sub>S</sub>				1	A
Drain-Source Diode Forward Voltage <sup>c</sup>	V <sub>SD</sub>	V <sub>GS</sub> = 0V, I <sub>S</sub> = 1A			1.1	V

**P-CH Electrical Characteristics (T<sub>A</sub>=25°C unless otherwise noted)**

Parameter	Symbol	Test Condition	Min	Typ	Max	Units
<b>Off Characteristics</b>						
Drain-Source Breakdown Voltage	BV <sub>DSS</sub>	V <sub>GS</sub> = 0V, I <sub>D</sub> = -250μA	-20			V
Zero Gate Voltage Drain Current	I <sub>DSS</sub>	V <sub>DS</sub> = -16V, V <sub>GS</sub> = 0V			-1	μA
Gate Body Leakage Current, Forward	I <sub>GSSF</sub>	V <sub>GS</sub> = 12V, V <sub>DS</sub> = 0V			100	nA
Gate Body Leakage Current, Reverse	I <sub>GSSR</sub>	V <sub>GS</sub> = -12V, V <sub>DS</sub> = 0V			-100	nA
<b>On Characteristics<sup>c</sup></b>						
Gate Threshold Voltage	V <sub>GS(th)</sub>	V <sub>GS</sub> = V <sub>DS</sub> , I <sub>D</sub> = -250μA	-0.4		-1.2	V
Static Drain-Source On-Resistance	R <sub>DS(on)</sub>	V <sub>GS</sub> = -4.5V, I <sub>D</sub> = -2.5A		85	100	mΩ
		V <sub>GS</sub> = -2.5V, I <sub>D</sub> = -1.5A		100	145	mΩ
<b>Dynamic Characteristics<sup>d</sup></b>						
Input Capacitance	C <sub>iss</sub>	V <sub>DS</sub> = -10V, V <sub>GS</sub> = 0V, f = 1.0 MHz		375		pF
Output Capacitance	C <sub>oss</sub>			90		pF
Reverse Transfer Capacitance	C <sub>rss</sub>			60		pF
<b>Switching Characteristics<sup>d</sup></b>						
Turn-On Delay Time	t <sub>d(on)</sub>	V <sub>DD</sub> = -10V, I <sub>D</sub> = -2.5A, V <sub>GS</sub> = -4.5V, R <sub>GEN</sub> = 3Ω		17		ns
Turn-On Rise Time	t <sub>r</sub>			17		ns
Turn-Off Delay Time	t <sub>d(off)</sub>			27		ns
Turn-Off Fall Time	t <sub>f</sub>			7		ns
Total Gate Charge	Q <sub>g</sub>	V <sub>DS</sub> = -10V, I <sub>D</sub> = -2.0A, V <sub>GS</sub> = -3.3V		2.9		nC
Gate-Source Charge	Q <sub>gs</sub>			0.46		nC
Gate-Drain Charge	Q <sub>gd</sub>			1.19		nC
<b>Drain-Source Diode Characteristics and Maximum Ratings</b>						
Drain-Source Diode Forward Current <sup>b</sup>	I <sub>S</sub>				-1	A
Drain-Source Diode Forward Voltage <sup>c</sup>	V <sub>SD</sub>	V <sub>GS</sub> = 0V, I <sub>S</sub> = -1A			-1.1	V

**N- Channel Typical Electrical and Thermal Characteristics**

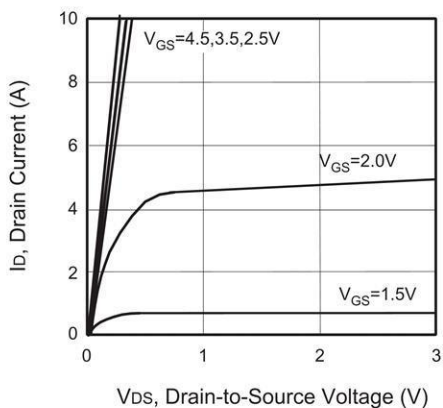

**Figure 1. Output Characteristics**

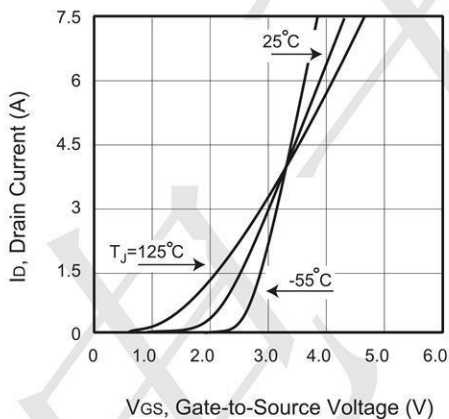

**Figure 2. Transfer Characteristics**

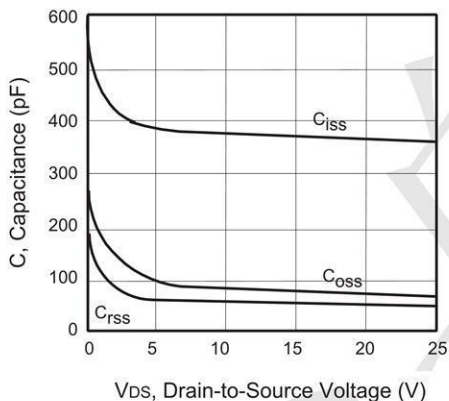

**Figure 3. Capacitance**

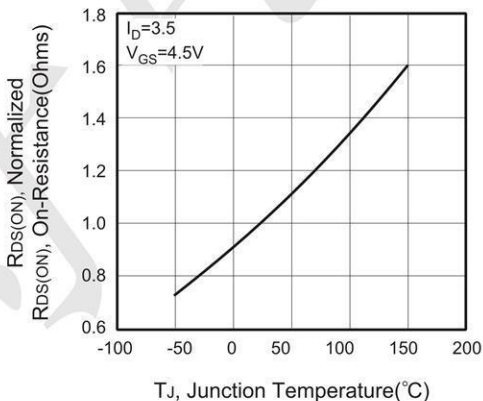

**Figure 4. On-Resistance Variation with Temperature**

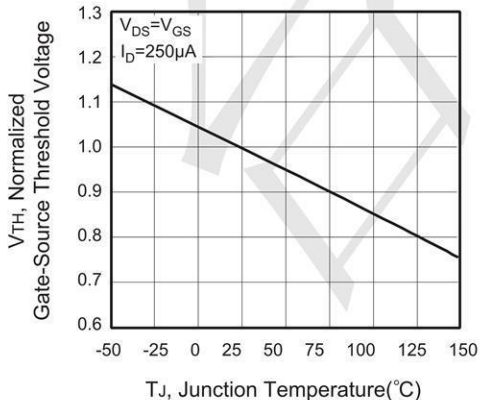

**Figure 5. Gate Threshold Variation with Temperature**

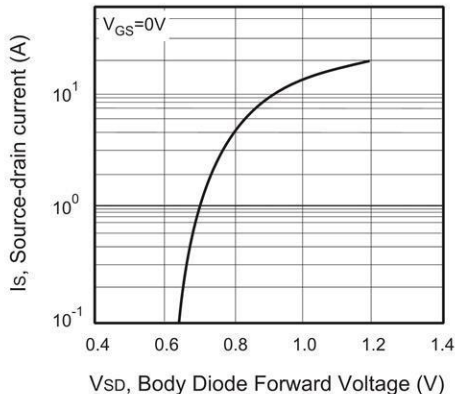

**Figure 6. Body Diode Forward Voltage Variation with Source Current**



**P-CHANNEL**

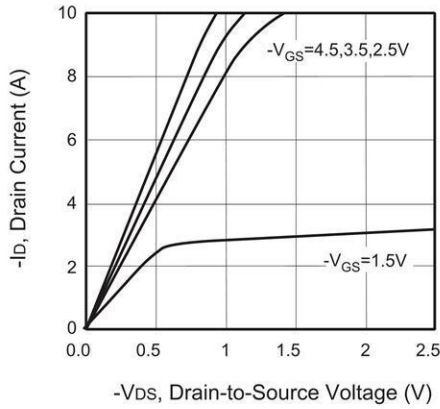

**Figure 1. Output Characteristics**

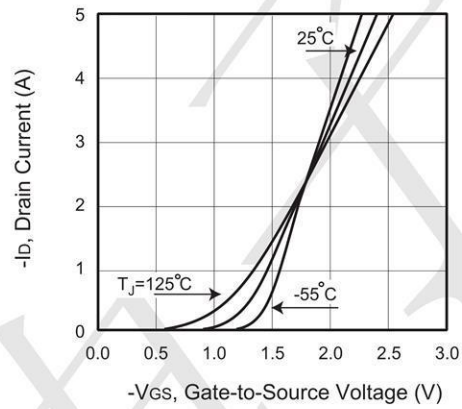

**Figure 2. Transfer Characteristics**

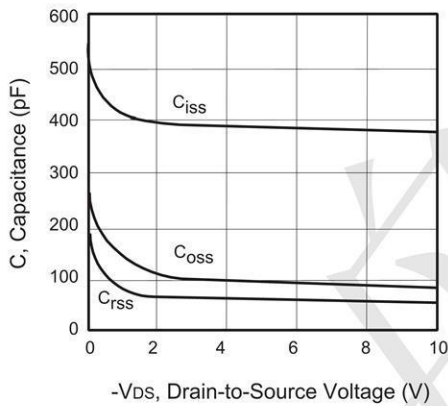

**Figure 3. Capacitance**

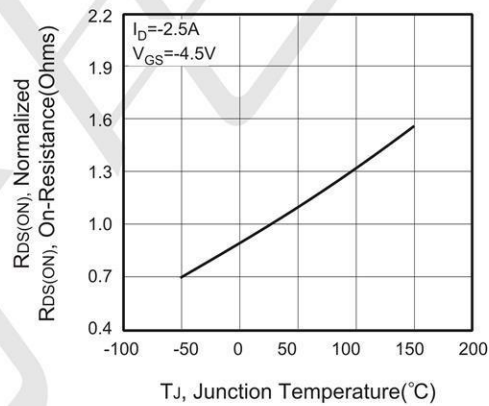

**Figure 4. On-Resistance Variation with Temperature**

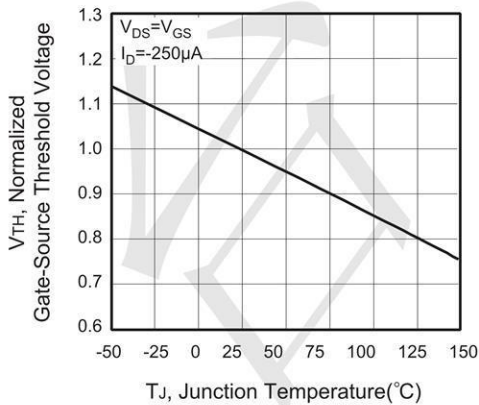

**Figure 5. Gate Threshold Variation with Temperature**

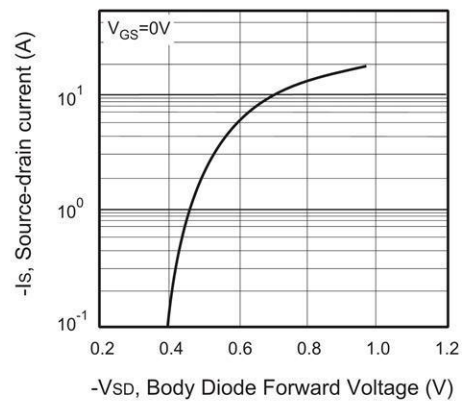

**Figure 6. Body Diode Forward Voltage Variation with Source Current**

**N-CHANNEL**

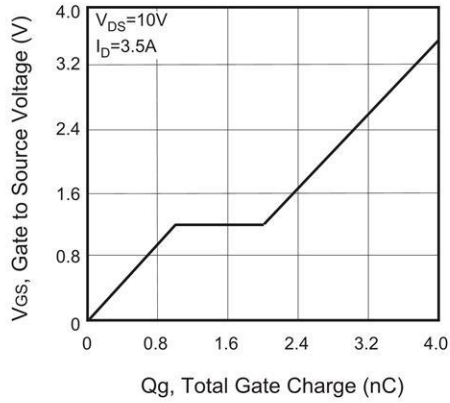

Figure 13. Gate Charge

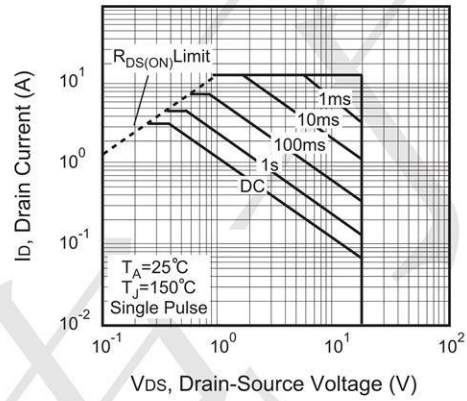

Figure 14. Maximum Safe Operating Area

**P-CHANNEL**

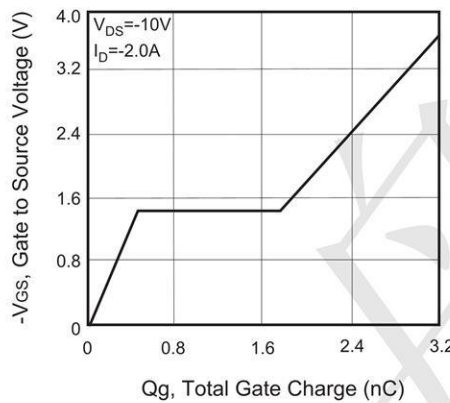

Figure 15. Gate Charge

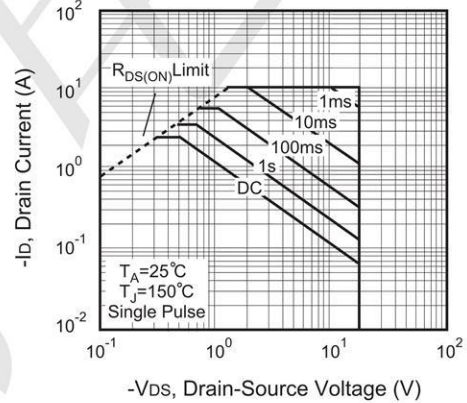

Figure 16. Maximum Safe Operating Area

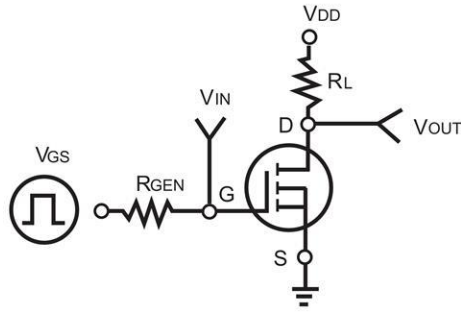

Figure 17. Switching Test Circuit

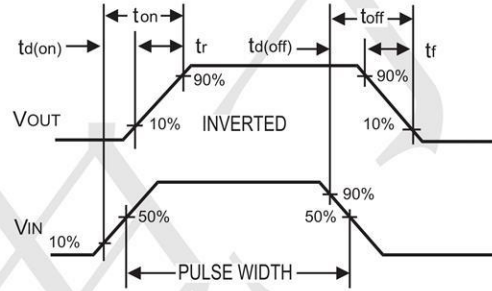

Figure 18. Switching Waveforms

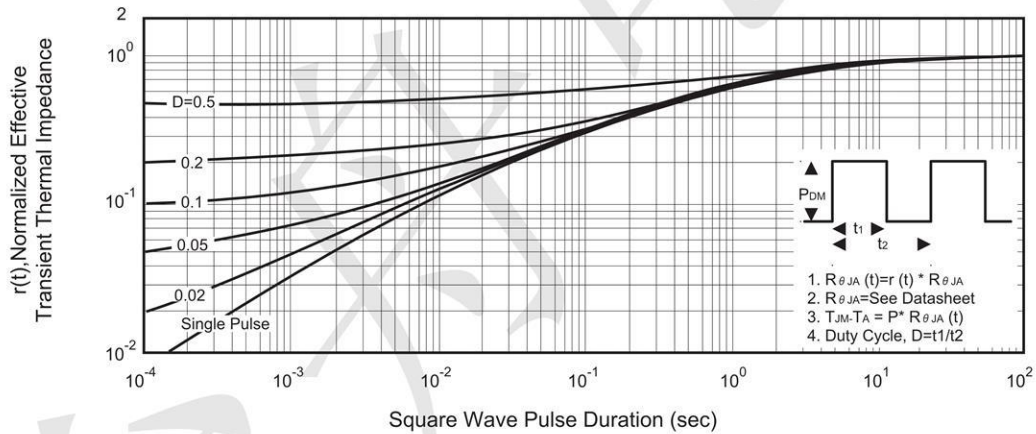

Figure 19. Normalized Thermal Transient Impedance Curve



**TECH PUBLIC**

—台丹电子—

**AO6604**

N and P-Channel Enhancement Mode Power MOSFET

[www.sot23.com.tw](http://www.sot23.com.tw)

**SOT23-6 Package Information**

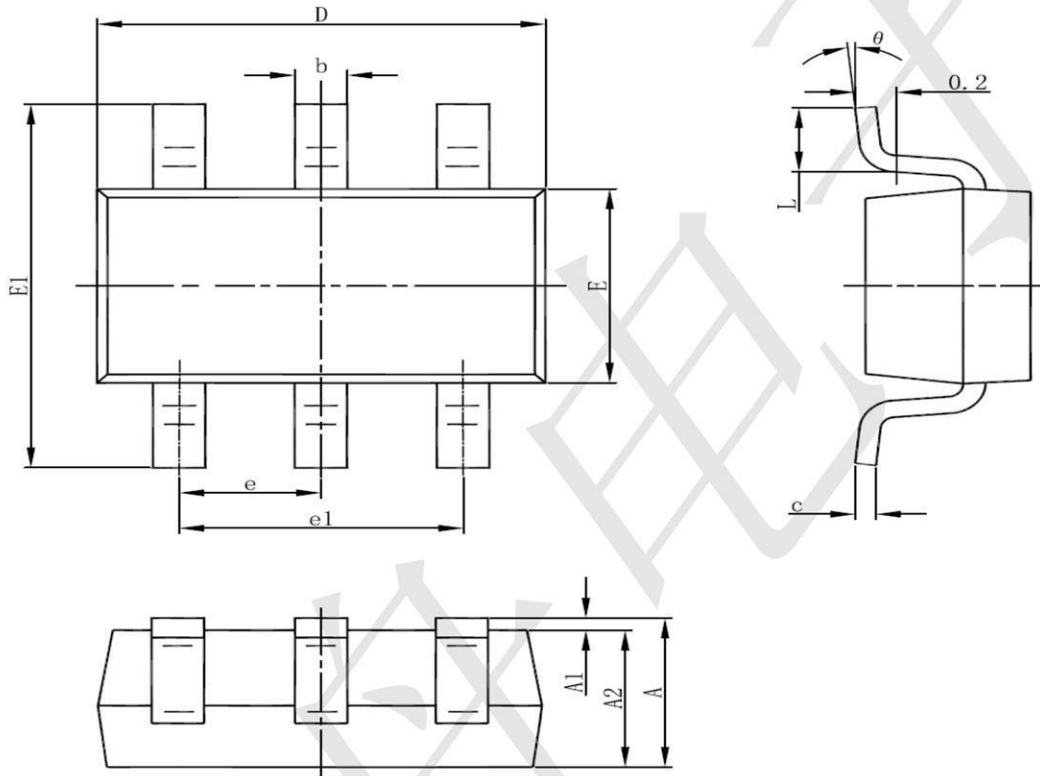

Symbol	Dimensions In Millimeters		Dimensions In Inches	
	Min	Max	Min	Max
A	1.050	1.250	0.041	0.049
A1	0.000	0.100	0.000	0.004
A2	1.050	1.150	0.041	0.045
b	0.300	0.500	0.012	0.020
c	0.100	0.200	0.004	0.008
D	2.820	3.020	0.111	0.119
E	1.500	1.700	0.059	0.067
E1	2.650	2.950	0.104	0.116
e	0.950(BSC)		0.037(BSC)	
e1	1.800	2.000	0.071	0.079
L	0.300	0.600	0.012	0.024
$\theta$	0°	8°	0°	8°



## X-ON Electronics

Largest Supplier of Electrical and Electronic Components

*Click to view similar products for [MOSFET](#) category:*

*Click to view products by [TECH PUBLIC](#) manufacturer:*

Other Similar products are found below :

[IRFD120](#) [JANTX2N5237](#) [2SK2267\(Q\)](#) [BUK455-60A/B](#) [TK100A10N1,S4X\(S](#) [MIC4420CM-TR](#) [VN1206L](#) [NDP4060](#) [SI4482DY](#)  
[IRS2092STRPBF-EL](#) [IPS70R2K0CEAKMA1](#) [SQM120N06-3M5L-GE3](#) [TK31J60W5,S1VQ\(O](#) [TK31J60W,S1VQ\(O](#) [TK16J60W,S1VQ\(O](#)  
[2SK2614\(TE16L1,Q\)](#) [DMN1017UCP3-7](#) [EFC2J004NUZTDG](#) [P85W28HP2F-7071](#) [NTE2384](#) [DMC2700UDMQ-7](#) [DMN2080UCB4-7](#)  
[DMN61D9UWQ-13](#) [US6M2GTR](#) [DMN31D5UDJ-7](#) [DMP22D4UFO-7B](#) [IPS60R3K4CEAKMA1](#) [DMN1006UCA6-7](#) [DMN16M9UCA6-7](#)  
[STF5N65M6](#) [IRF40H233XTMA1](#) [STU5N65M6](#) [DMN6022SSD-13](#) [DMN13M9UCA6-7](#) [DMTH10H4M6SPS-13](#) [IPS60R360PFD7SAKMA1](#)  
[DMN2990UFB-7B](#) [SSM3K35CT,L3F](#) [IPLK60R1K0PFD7ATMA1](#) [2N7002W-G](#) [MCAC30N06Y-TP](#) [IPWS65R035CFD7AXKSA1](#)  
[MCQ7328-TP](#) [SSM3J143TU,LXHF](#) [PJMF280N65E1\\_T0\\_00201](#) [PJMF380N65E1\\_T0\\_00201](#) [PJMF280N60E1\\_T0\\_00201](#)  
[PJMF600N65E1\\_T0\\_00201](#) [PJMF900N65E1\\_T0\\_00201](#) [PJMF900N60E1\\_T0\\_00201](#)