

FEATURES

N channel

- $V_{DS} = 60V, I_D = 15A$
- $R_{DS(ON)} < 40m\Omega @ V_{GS} = 10V$
- $R_{DS(ON)} < 71m\Omega @ V_{GS} = 4.5V$

p channel

- $V_{DS} = -60V, I_D = -15A$
- $R_{DS(ON)} < 65m\Omega @ V_{GS} = -10V$
- $R_{DS(ON)} < 85m\Omega @ V_{GS} = -4.5V$

Application

- Motor/Body Load Control
- Load Switch
- PWM Application
- DC-DC converters and Off-line UPS

PIN CONFIGURATION

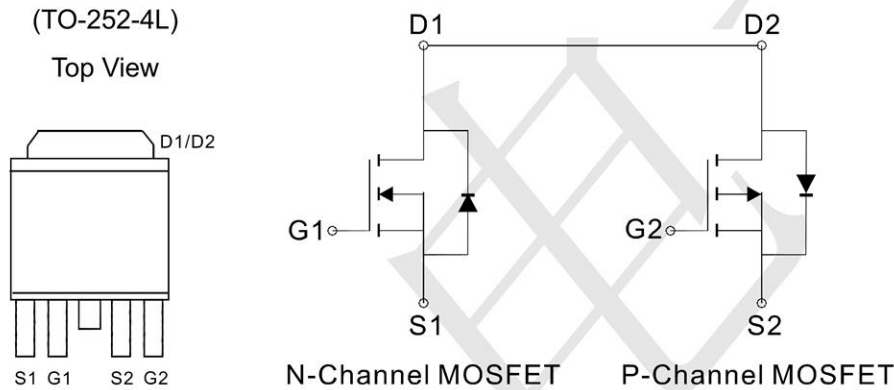

Marking: 6020

Absolute Maximum Ratings ($T_C = 25^\circ C$ unless otherwise noted)

Parameter		Symbol	N-Channel	P-Channel	Unit
Drain-Source Voltage		V_{DS}	60	-60	V
Gate-Source Voltage		V_{GS}	± 20	± 20	V
Continuous Drain Current	$T_C = 25^\circ C$	I_D	15	-15	A
	$T_C = 100^\circ C$		10.6	-10.6	
Pulsed Drain Current (Note 1)		I_{DM}	60	-60	A
Maximum Power Dissipation	$T_C = 25^\circ C$	P_D	35		W
Operating Junction and Storage Temperature Range		T_J, T_{STG}	-55 To 175		$^\circ C$

Thermal Characteristic

Thermal Resistance, Junction-to-Case (Note 2)	$R_{\theta JC}$	4.3	$^\circ C/W$
---	-----------------	-----	--------------

N-Channel Electrical Characteristics (T_C=25°C unless otherwise noted)

Parameter	Symbol	Condition	Min	Typ	Max	Unit
Off Characteristics						
Drain-Source Breakdown Voltage	BV _{DSS}	V _{GS} =0V, I _D =250μA	60	-	-	V
Zero Gate Voltage Drain Current	I _{DSS}	V _{DS} =60V, V _{GS} =0V	-	-	1	μA
Gate-Body Leakage Current	I _{GSS}	V _{GS} =±20V, V _{DS} =0V	-	-	±100	nA
On Characteristics (Note 3)						
Gate Threshold Voltage	V _{GS(th)}	V _{DS} =V _{GS} , I _D =250μA	1.2	1.9	2.5	V
Drain-Source On-State Resistance	R _{DS(on)}	V _{GS} =10V, I _D =10A	-	34	40	mΩ
		V _{GS} =4.5V, I _D =10A	-	59	71	
Forward Transconductance	g _{FS}	V _{DS} =5V, I _D =10A	8	-	-	S
Dynamic Characteristics (Note 4)						
Input Capacitance	C _{iss}	V _{DS} =30V, V _{GS} =0V, F=1.0MHz	-	551	-	PF
Output Capacitance	C _{OSS}		-	42	-	PF
Reverse Transfer Capacitance	C _{rss}		-	38.5	-	PF
Switching Characteristics (Note 4)						
Turn-on Delay Time	t _{d(on)}	V _{DD} =30V, R _L =3Ω V _{GS} =10V, R _G =3Ω	-	5	-	nS
Turn-on Rise Time	t _r		-	2.6	-	nS
Turn-Off Delay Time	t _{d(off)}		-	16.1	-	nS
Turn-Off Fall Time	t _f		-	2.3	-	nS
Total Gate Charge	Q _g	V _{DS} =30V, I _D =10A, V _{GS} =10V	-	17.1	-	nC
Gate-Source Charge	Q _{gs}		-	3.6	-	nC
Gate-Drain Charge	Q _{gd}		-	4.5	-	nC
Drain-Source Diode Characteristics						
Diode Forward Voltage (Note 3)	V _{SD}	V _{GS} =0V, I _S =10A	-	-	1.2	V
Diode Forward Current (Note 2)	I _S		-	-	15	A
Reverse Recovery Time	t _{rr}	T _J = 25°C, I _F =10A di/dt = 100A/μs (Note 3)	-	29	-	nS
Reverse Recovery Charge	Q _{rr}		-	49	-	nC
Forward Turn-On Time	t _{on}	Intrinsic turn-on time is negligible (turn-on is dominated by LS+LD)				

P-Channel Electrical Characteristics (T_C=25°C unless otherwise noted)

Parameter	Symbol	Condition	Min	Typ	Max	Unit
Off Characteristics						
Drain-Source Breakdown Voltage	BV _{DSS}	V _{GS} =0V, I _D =-250μA	-60	-	-	V
Zero Gate Voltage Drain Current	I _{DSS}	V _{DS} =-60V, V _{GS} =0V	-	-	-1	μA
Gate-Body Leakage Current	I _{GSS}	V _{GS} =±20V, V _{DS} =0V	-	-	±100	nA
On Characteristics (Note 3)						
Gate Threshold Voltage	V _{GS(th)}	V _{DS} =V _{GS} , I _D =-250μA	-1.0	1.5	-2.0	V
Drain-Source On-State Resistance	R _{DS(ON)}	V _{GS} =-10V, I _D =-10A	-	55	65	mΩ
		V _{GS} =-4.5V, I _D =-10A	-	65	85	mΩ
Forward Transconductance	g _{FS}	V _{DS} =-5V, I _D =-10A	-	15	-	S
Dynamic Characteristics (Note 4)						
Input Capacitance	C _{ISS}	V _{DS} =-30V, V _{GS} =0V, F=1.0MHz	-	1108	-	PF
Output Capacitance	C _{OSS}		-	73.7	-	PF
Reverse Transfer Capacitance	C _{RSS}		-	58.2	-	PF
Switching Characteristics (Note 4)						
Turn-on Delay Time	t _{d(on)}	V _{DD} =-30V, R _L =3Ω, V _{GS} =-10V, R _G =3Ω	-	8	-	nS
Turn-on Rise Time	t _r		-	4	-	nS
Turn-Off Delay Time	t _{d(off)}		-	32	-	nS
Turn-Off Fall Time	t _f		-	7	-	nS
Total Gate Charge	Q _g	V _{DS} =-30, I _D =-10A, V _{GS} =-10V	-	23.4	-	nC
Gate-Source Charge	Q _{gs}		-	4.1	-	nC
Gate-Drain Charge	Q _{gd}		-	4.8	-	nC
Drain-Source Diode Characteristics						
Diode Forward Voltage (Note 3)	V _{SD}	V _{GS} =0V, I _S =-10A	-	-	-1.2	V
Diode Forward Current (Note 2)	I _S		-	-	-15	A
Reverse Recovery Time	t _{rr}	T _J = 25°C, I _F = -10A	-	25		nS
Reverse Recovery Charge	Q _{rr}	di/dt = -100A/μs (Note 3)	-	31		nC

N-Channel Typical Electrical and Thermal Characteristics (Curves)

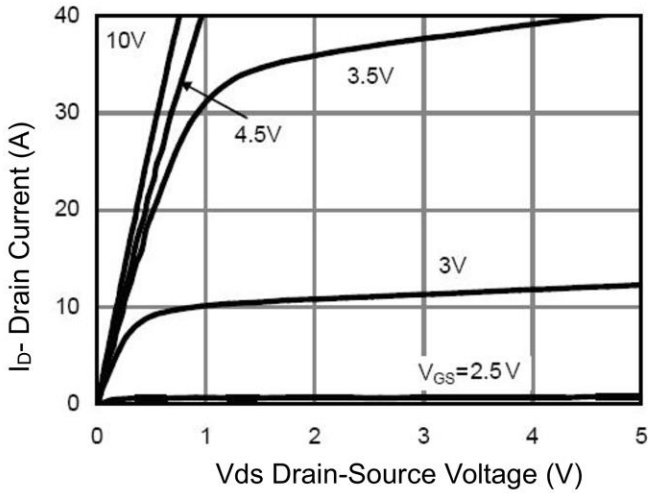

Figure 1 Output Characteristics

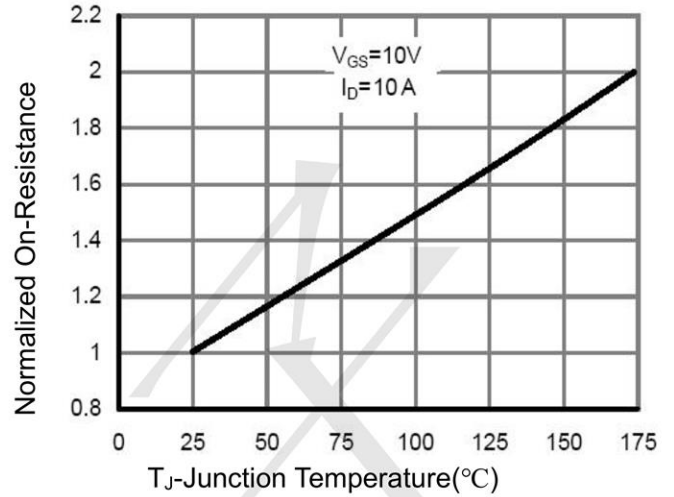

Figure 4 Rdson-Junction Temperature

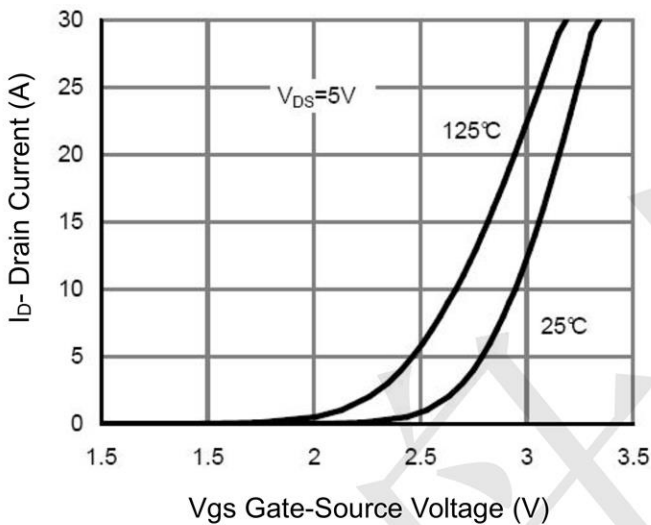

Figure 2 Transfer Characteristics

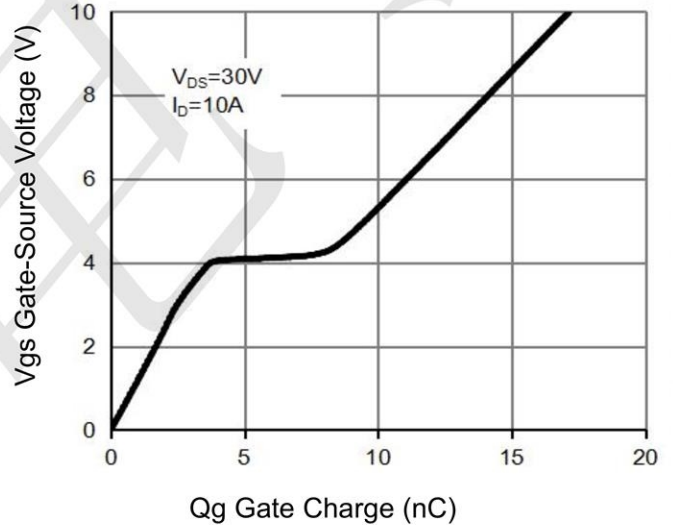

Figure 5 Gate Charge

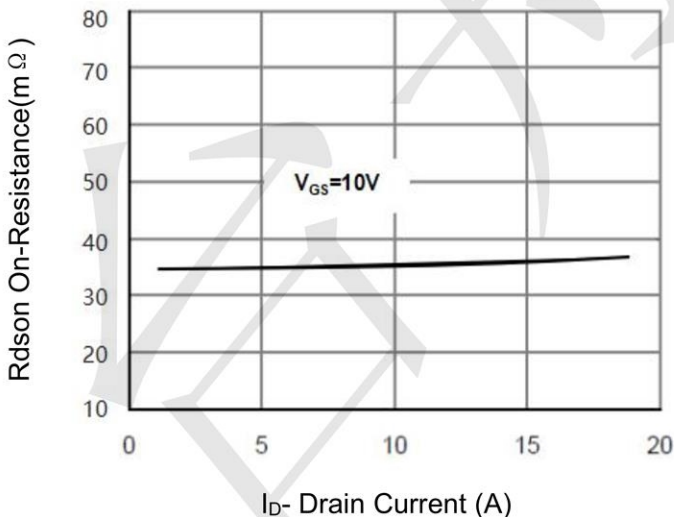

Figure 3 Rdson- Drain Current

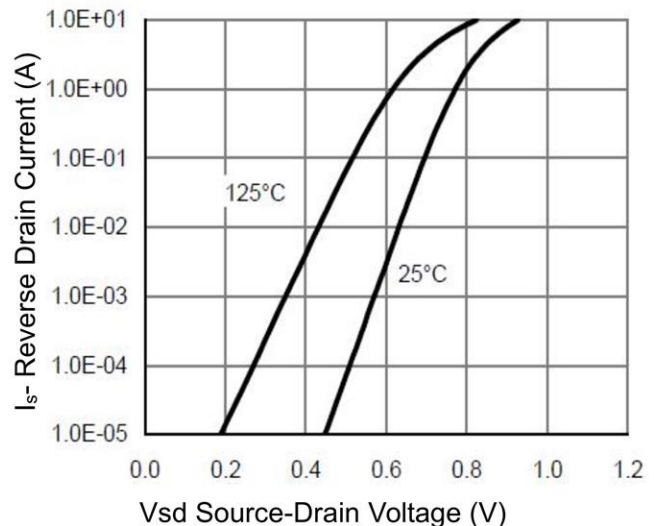

Figure 6 Source- Drain Diode Forward

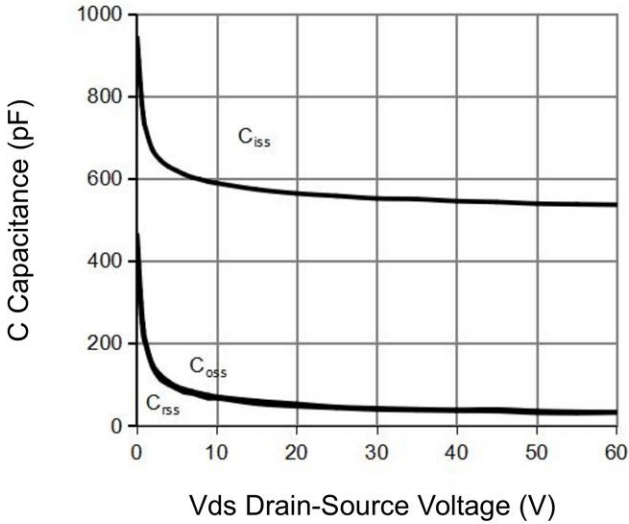

Figure 7 Capacitance vs Vds

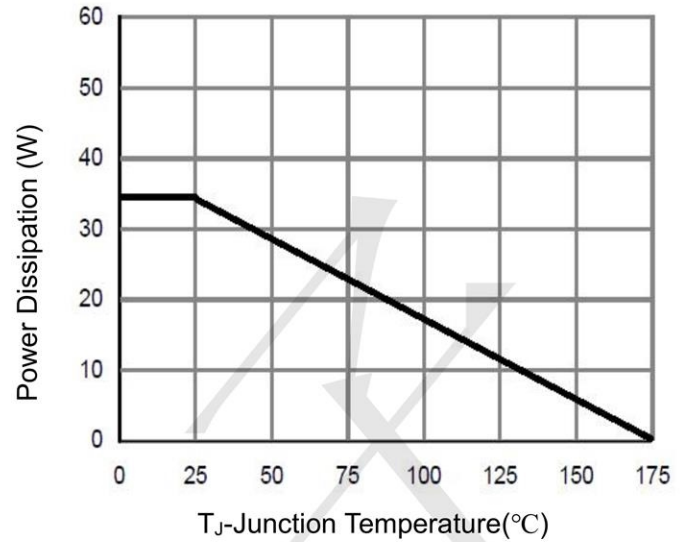

Figure 9 Power De-rating

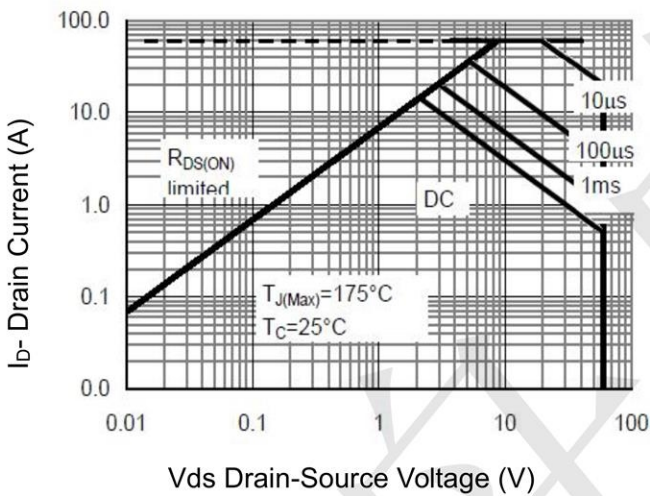

Figure 8 Safe Operation Area

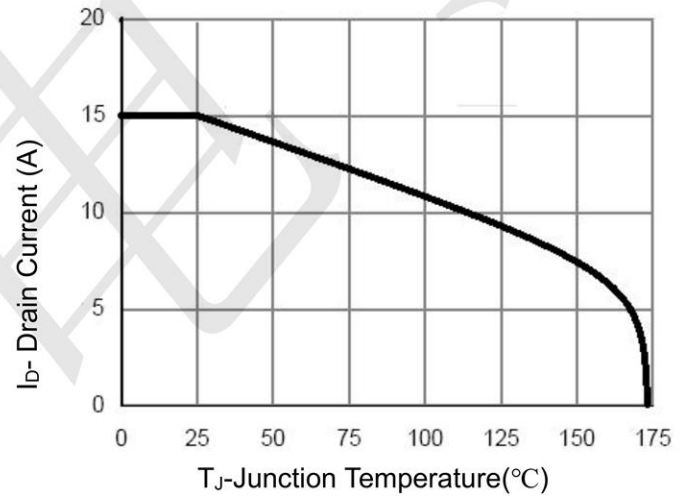
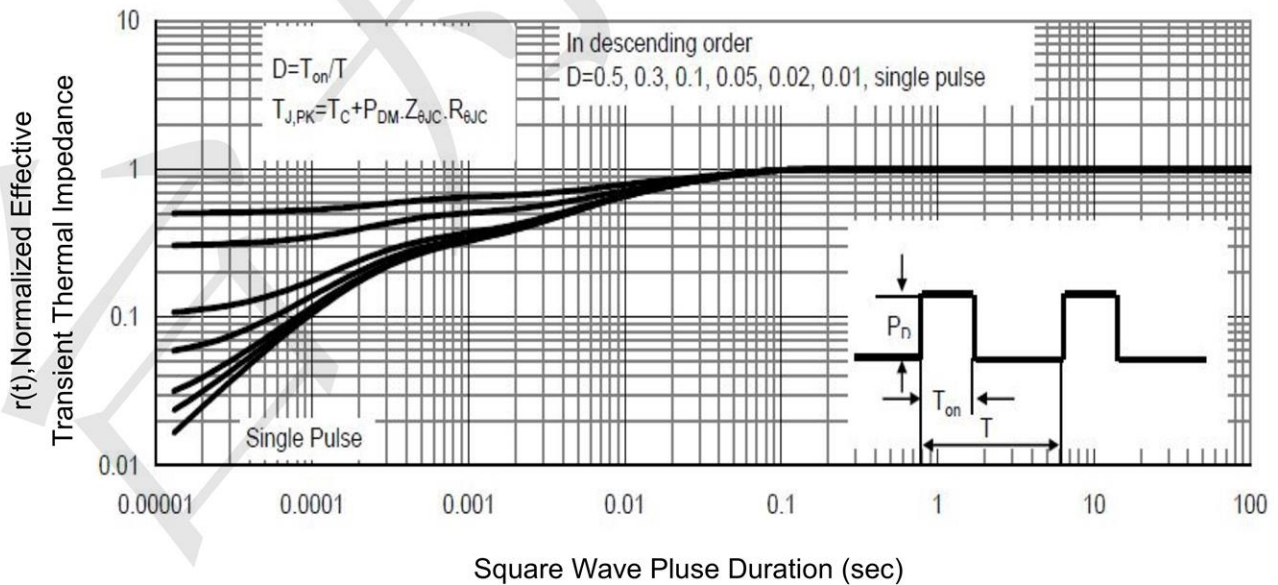

Figure 10 ID Current De-rating





P-Channel Typical Electrical and Thermal Characteristics (Curves)

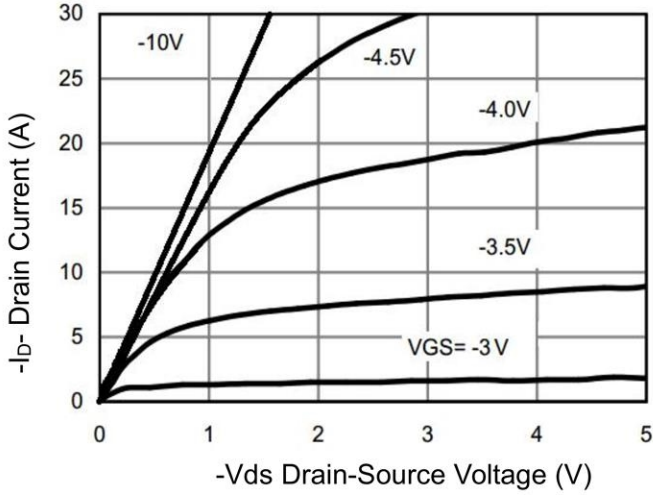

Figure 1 Output Characteristics

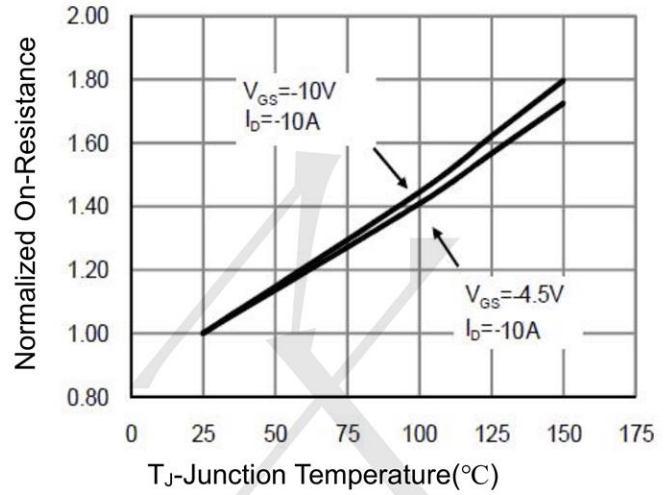

Figure 4 Rdson-Junction Temperature

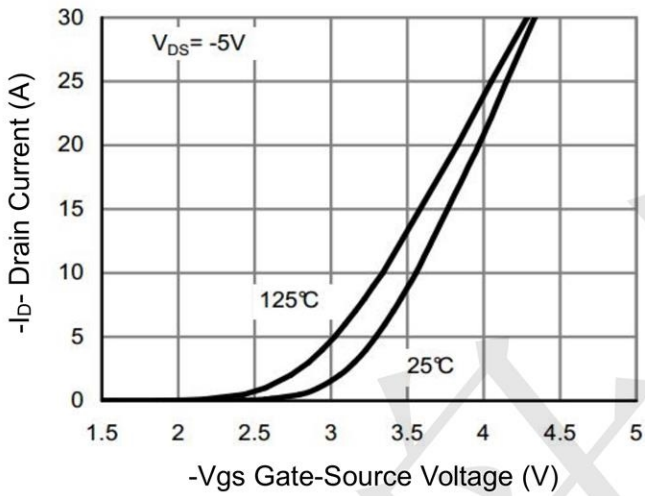

Figure 2 Transfer Characteristics

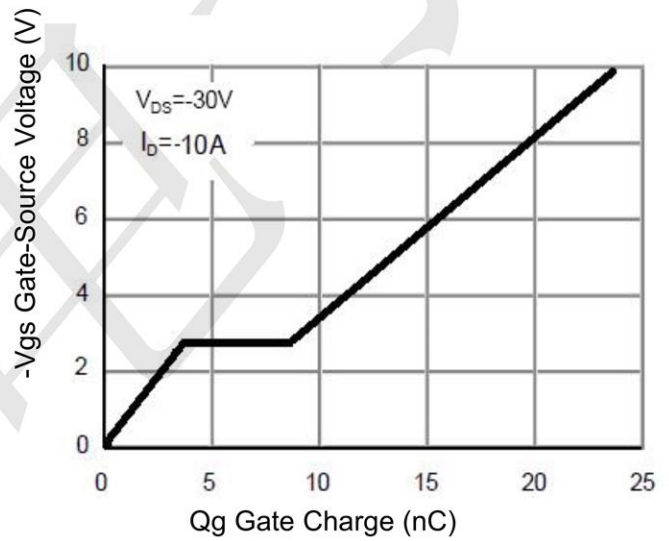

Figure 5 Gate Charge

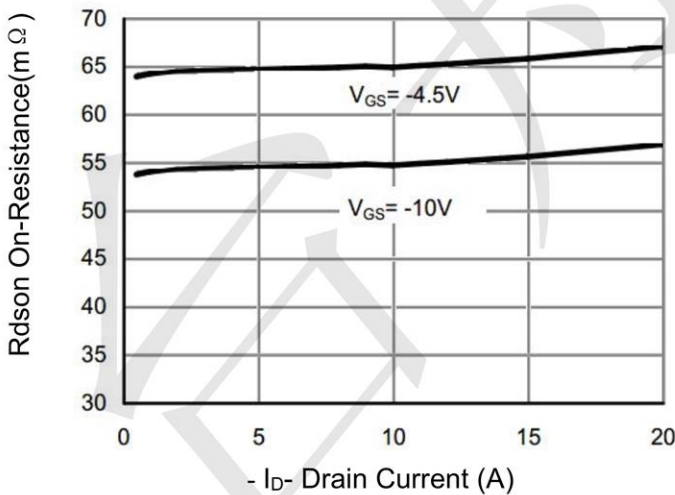

Figure 3 Rdson- Drain Current

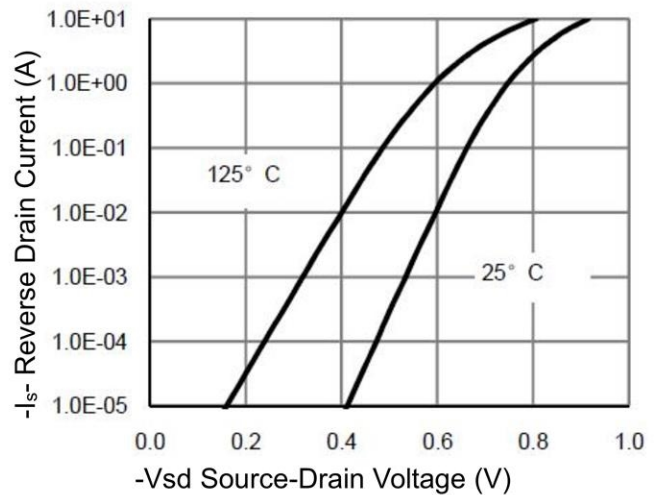

Figure 6 Source- Drain Diode Forward

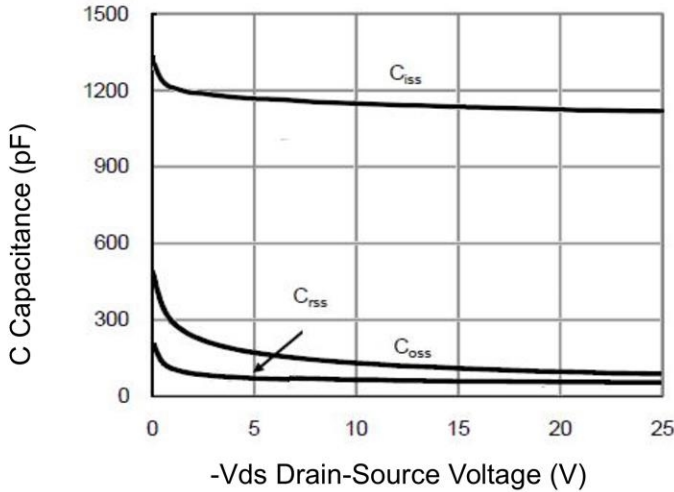

Figure 7 Capacitance vs Vds

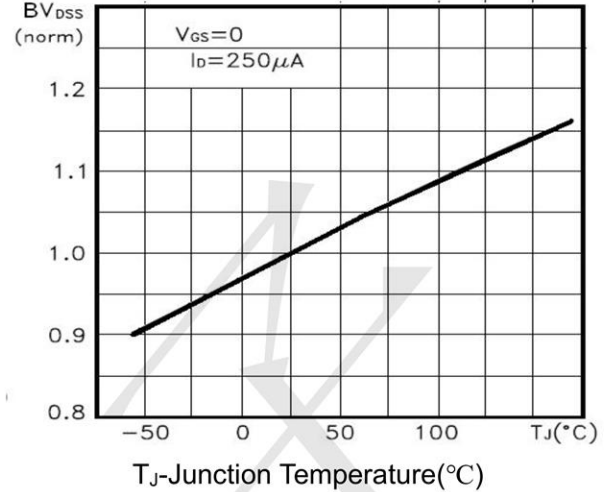

Figure 9 BV_{DSS} vs Junction Temperature

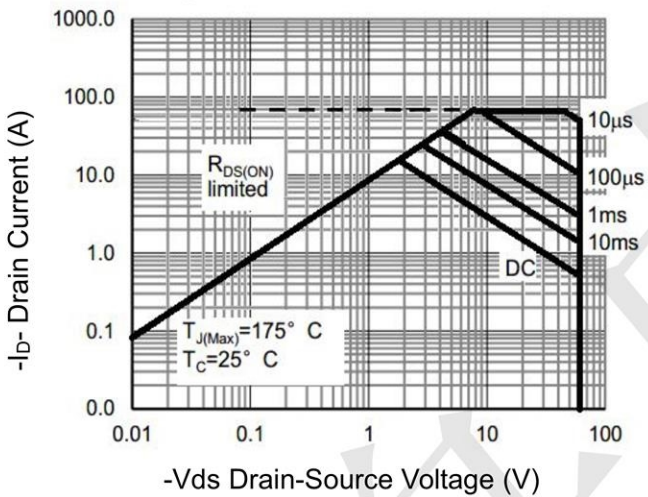

Figure 8 Safe Operation Area

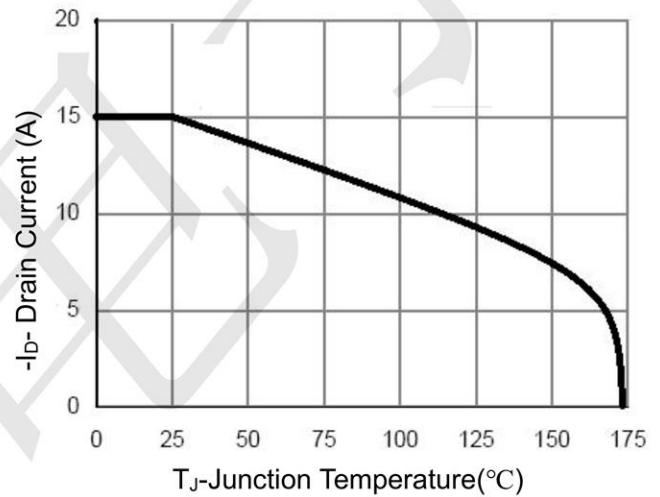

Figure 10 I_D Current De-rating

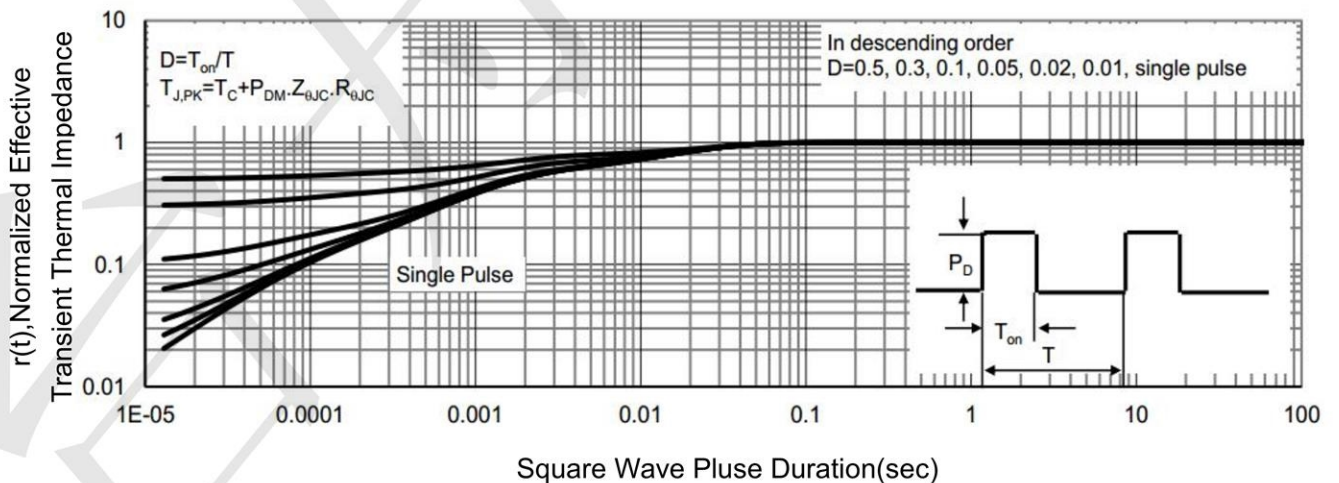
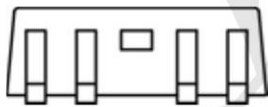
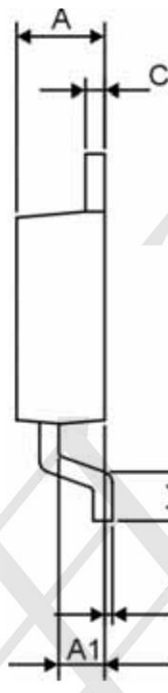
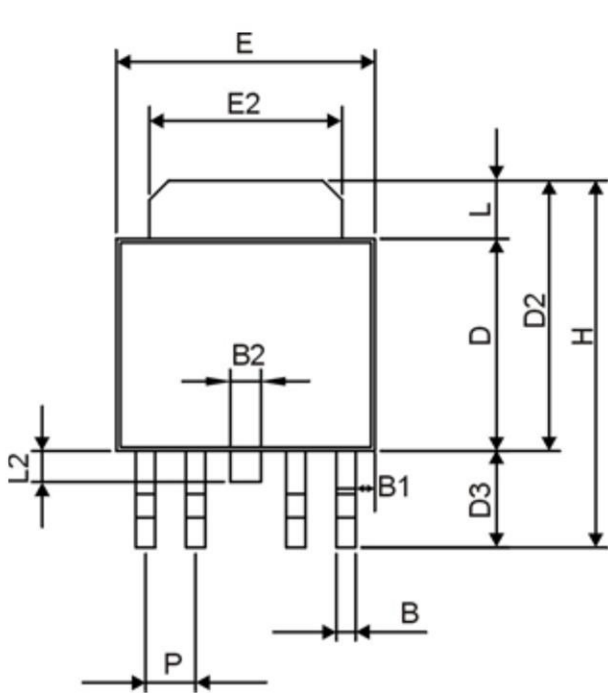

Figure 11 Normalized Maximum Transient Thermal Impedance

Package Outline Dimensions TO-252-4L Package



DIM	MILLIMETERS (mm)	
	MIN	MAX
A	2.20	2.50
A1	1.10	1.30
B	0.30	0.75
B1	0.55	0.75
B2	0.40	0.80
C	0.40	0.60
D	5.20	5.70
D2	6.50	7.30
D3	2.20	3.00
E	6.30	6.70
E2	4.50	5.50
H	9.50	10.50
L	1.30	1.70
L1	0.90	1.70
L2	0.50	1.10
L3	0.00	0.30
P	1.20	1.40

X-ON Electronics

Largest Supplier of Electrical and Electronic Components

Click to view similar products for [MOSFET](#) category:

Click to view products by [TECH PUBLIC](#) manufacturer:

Other Similar products are found below :

[IRFD120](#) [IRFY240C](#) [JANTX2N5237](#) [2SK2267\(Q\)](#) [BUK455-60A/B](#) [MIC4420CM-TR](#) [VN1206L](#) [NDP4060](#) [SI4482DY](#)
[IPS70R2K0CEAKMA1](#) [SQD23N06-31L-GE3](#) [TK16J60W,S1VQ\(O](#) [2SK2614\(TE16L1,Q\)](#) [DMN1017UCP3-7](#) [EFC2J004NUZTDG](#)
[DMN1053UCP4-7](#) [SQJ469EP-T1-GE3](#) [NTE2384](#) [DMC2700UDMQ-7](#) [DMN2080UCB4-7](#) [DMN61D9UWQ-13](#) [US6M2GTR](#)
[DMN31D5UDJ-7](#) [DMP22D4UFO-7B](#) [DMN1006UCA6-7](#) [DMN16M9UCA6-7](#) [STF5N65M6](#) [IRF40H233XTMA1](#) [STU5N65M6](#)
[DMN6022SSD-13](#) [DMN13M9UCA6-7](#) [DMTH10H4M6SPS-13](#) [DMN2990UFB-7B](#) [IPB80P04P405ATMA2](#) [2N7002W-G](#) [MCAC30N06Y-](#)
[TP](#) [MCQ7328-TP](#) [NTMC083NP10M5L](#) [NVMFS2D3P04M8LT1G](#) [BXP7N65D](#) [BXP4N65F](#) [AOL1454G](#) [WMJ80N60C4](#) [BXP2N20L](#)
[BXP2N65D](#) [BXT1150N10J](#) [BXT1700P06M](#) [TSM60NB380CP](#) [ROG](#) [RQ7L055BGTCR](#) [DMNH15H110SK3-13](#)