

Features

- 10 μ A Ground Current at no Load
- $\pm 2\%$ Output Accuracy
- 600mA Output Current
- 10nA Disable Current (by option)
- Wide Operating Input Voltage Range: 1.2V to 5.5V
- Dropout Voltage: 0.32V at 600mA/ V_{OUT} 3.3V
- Support Fixed Output Voltage 1.2V, 1.5V, 1.6V, 1.8V, 2.5V, 2.8V, 3.0V, 3.3V
- Stable with Ceramic or Tantalum Capacitor
- Current Limit Protection
- Over Temperature Protection
- SOT23-5 Packages

General Description

This production is group of low-dropout (LDO) voltage regulators offering the benefits of wide input voltage range from 1.2V to 5.5V, low dropout voltage, low power consumption, and miniaturized packaging. Quiescent current of only 10 μ A makes these devices ideal for powering the battery-powered, always-on systems that require very little idle-state power dissipation to a longer service life. There is an option of

shutdown mode by selecting the parts with the EN pin and pulling it low. The shutdown current in this mode goes down to only 10nA (typical).

This production is of linear regulators are stable with the ceramic output capacitor over its wide input range from 1.2V to 5.5V and the entire range of output load current (0mA to 600mA).

Ordering Information

AP2112K-3.3TRG1

Output voltage: 1.2=1.2V
1.8=1.8V
3.0=3.0V
3.3=3.3V
3.6=3.6V

PIN CONFIGURATION

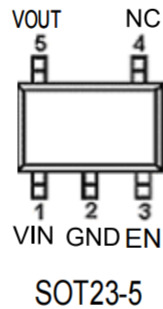

Typical Application Circuit

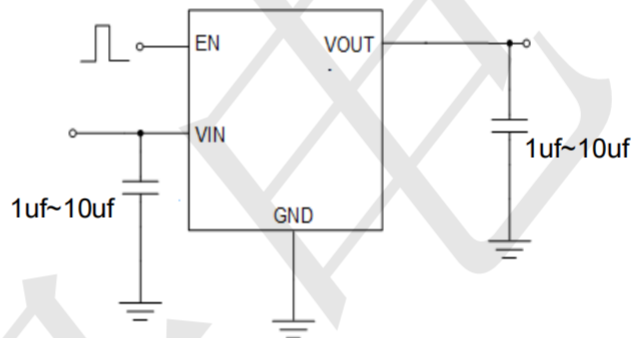

Figure 2: Application circuit of Fixed V_{OUT} LDO with enable function

ABSOLUTE MAXIMUM RATINGS

| | | |
|---|------------------|---------------|
| VIN Pin to GND Pin Voltage | | -0.3V to 6.5V |
| VOUT Pin and EN Voltage | | -0.3V to 6V |
| VOUT Pin to VIN Pin Voltage | | -6V to 0.3V |
| Storage Temperature Range | | -60°C~150°C |
| Lead Temperature (Soldering, 10 sec) | | 260°C |
| Junction Temperature | | 150°C |
| Operating Ambient Temperature Range T_A | | -40°C~85°C |
| Thermal Resistance Junction to Case, $R_{\theta JC}$ | SOT23-3 | 115°C/W |
| | SOT23-5 | 115°C/W |
| | DFN-4(1x1) | 65°C/W |
| | DFN-6(2x2) | 30°C/W |
| Thermal Resistance Junction to Ambient, $R_{\theta JA}$ | SOT23-3 | 250°C/W |
| | SOT23-5 | 250°C/W |
| | DFN-4(1x1) | 195°C/W |
| | DFN-6(2x2) | 165°C/W |

Electrical Characteristics (T_A=25°C unless otherwise noted)

(V_{IN} = 5V, V_{EN} = 5V T_A=25°C unless otherwise specified)

| Parameter | Symbol | Test Conditions | Min | Typ | Max | Unit | |
|--|------------------------|---|-------------------------|------|-----|------|-------------------|
| Supply Voltage | V _{IN} | | 1.2 | -- | 5.5 | V | |
| DC Output Voltage Accuracy | | I _{LOAD} = 0.1mA | -2 | | 2 | % | |
| Dropout Voltage (I _{LOAD} = 600mA) (Note 3) | V _{DROP_3V} | V _{OUT} ≥ 3V | | 0.32 | | V | |
| | V _{DROP_2.8V} | V _{OUT} = 2.8V | | 0.36 | | | |
| | V _{DROP_2.5V} | V _{OUT} = 2.5V | | 0.36 | | | |
| | V _{DROP_1.8V} | V _{OUT} = 1.8V | | 0.57 | | | |
| | V _{DROP_1.5V} | V _{OUT} = 1.5V | | 0.71 | | | |
| | V | V = 1.2V | | 0.8 | | | |
| Ground Current | I _Q | I _{LOAD} = 0mA | | 10 | | μA | |
| Shutdown Ground Current | I _{SD} | V _{EN} = 0V, | | 0.01 | 0.5 | μA | |
| V _{OUT} Shutdown Leakage Current | I _{LEAK} | V _{OUT} = 0V | | 0.01 | 0.5 | | |
| Enable Threshold Voltage | V _{IH} | EN Rising | | | 2 | V | |
| | V _{IL} | EN Falling | 0.6 | | | | |
| EN Input Current | I _{EN} | V _{EN} = 5V | | 10 | 100 | nA | |
| Line Regulation | Δ _{LINE} | I _{LOAD} = 30mA, 1.5V ≤ V _{IN} ≤ 5.5V or (V _{OUT} + 0.2V) ≤ V _{IN} ≤ 5.5V | | 0.2 | | % | |
| Load Regulation | Δ _{LOAD} | 10mA ≤ I _{LOAD} ≤ 0.3A | | 0.2 | | % | |
| Output Current Limit | I _{LIM} | V _{OUT} = 0 | 601 | 1100 | | mA | |
| Power Supply Rejection Ratio (I _{LOAD} = 5mA) | PSRR | V _{OUT} = 1.2V, V _{IN} = 2V | f = 100Hz | -- | 80 | -- | dB |
| | | | f = 1kHz | -- | 75 | -- | |
| Output Voltage Noise (BW = 10Hz to 100kHz, C _{OUT} = 1μF.) | | V _{IN} = 3.5V I _{LOAD} = 0.1A | V _{OUT} = 0.9V | -- | 40 | -- | μV _{RMS} |
| | | | V _{OUT} = 2.8V | -- | 50 | -- | |
| Thermal Shutdown Temperature | T _{SD} | I _{LOAD} = 10mA | | -- | 155 | -- | °C |
| Thermal Shutdown Hysteresis | ΔT _{SD} | | | -- | 15 | -- | °C |
| Discharge Resistance | | EN = 0V, V _{OUT} = 0.1V | -- | 100 | -- | Ω | |

Note 1. Stresses beyond those listed “Absolute Maximum Ratings” may cause permanent damage to the device. These are stress ratings only, and functional operation of the device at these or any other conditions beyond those indicated in the operational sections of the specifications is not implied. Exposure to absolute maximum rating conditions may affect device reliability.

Note 2. θ_{JA} is measured at $T_A = 25^\circ\text{C}$ on a TECH PUBLIC board.

Note 3. $V_{DROP} = V_{IN} - V_{OUT}$ when the V_{OUT} is 98% of its target value.

Typical Characteristics

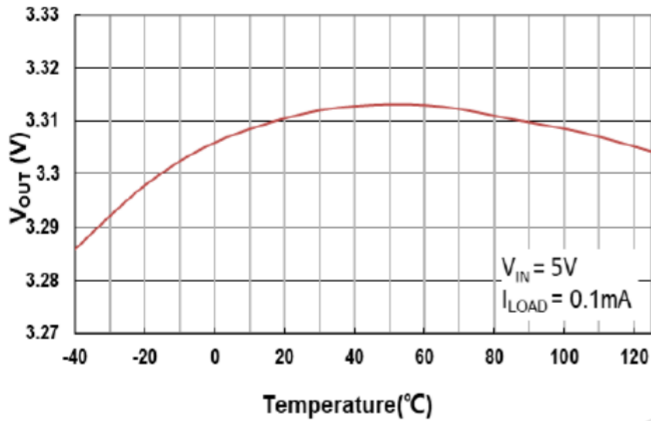

Fig. 5 Output Voltage vs. Temperature

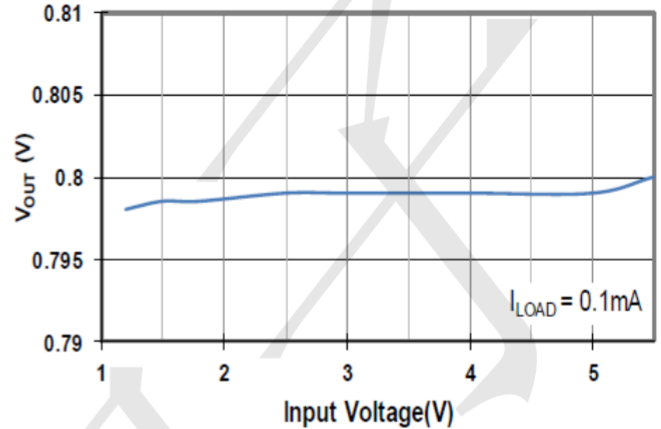

Fig. 6 Output Voltage vs. Input Voltage

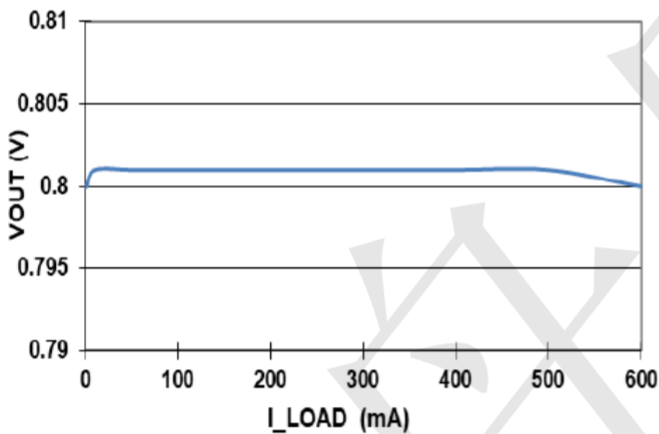

Fig. 7 Output Voltage vs. Load Current

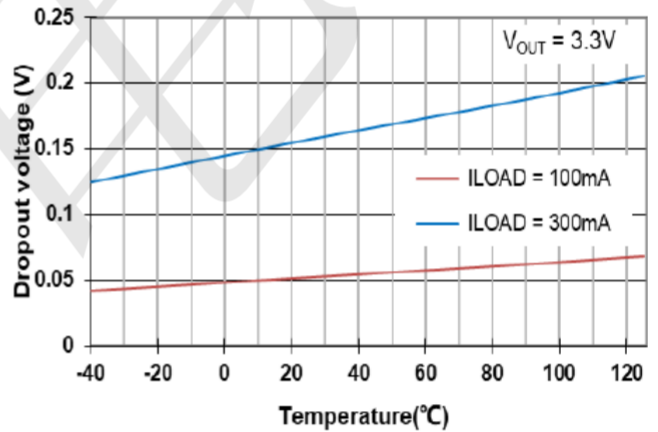

Fig. 8 Dropout Voltage vs. Temperature

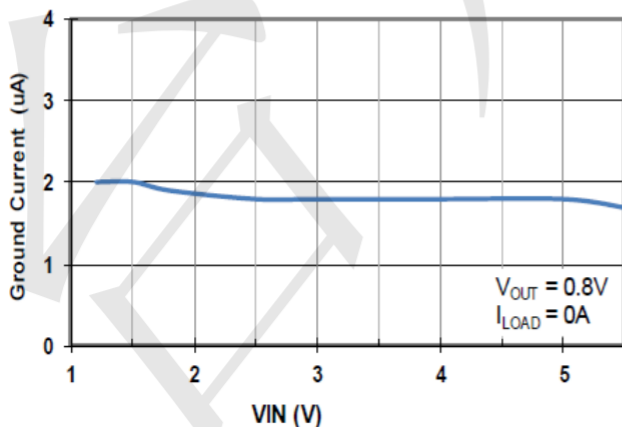

Fig. 9 Ground Current vs. Input Voltage

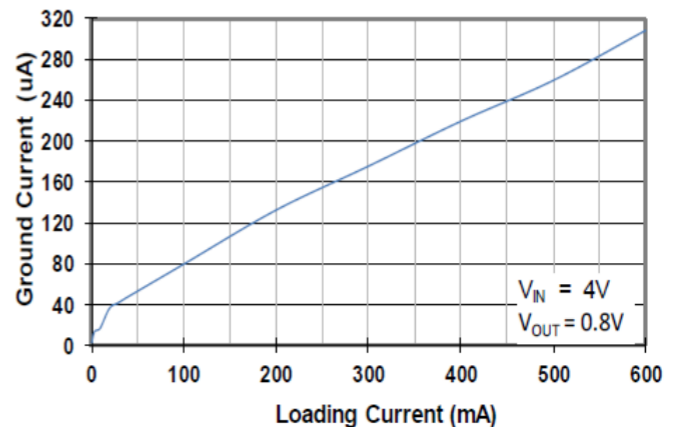
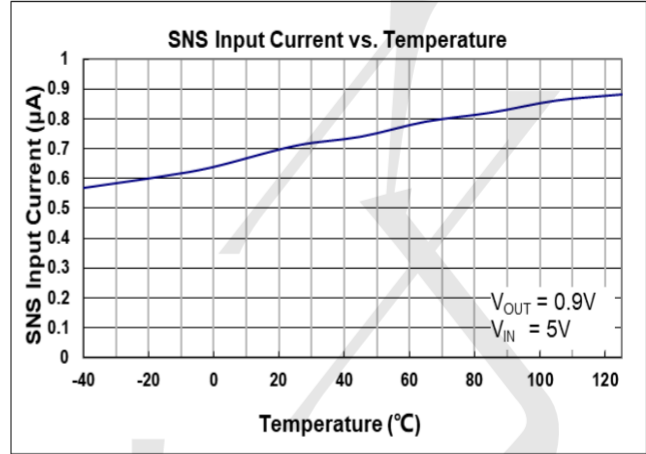
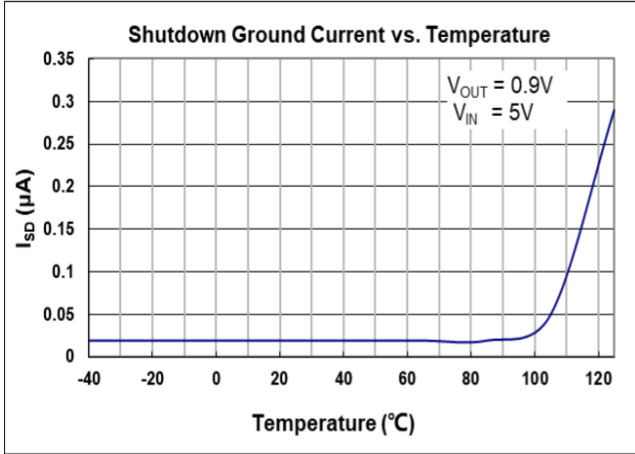
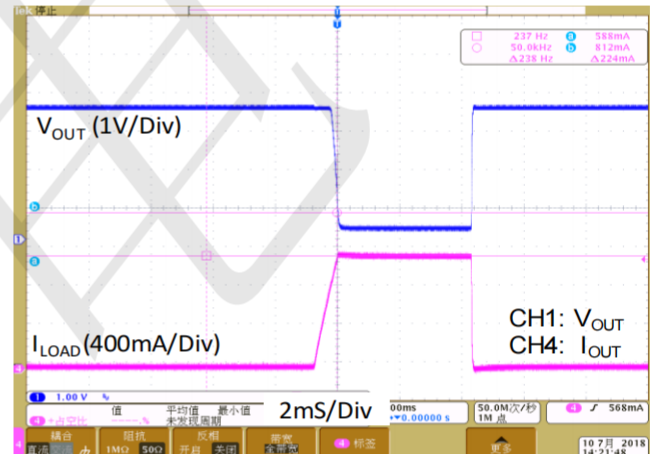
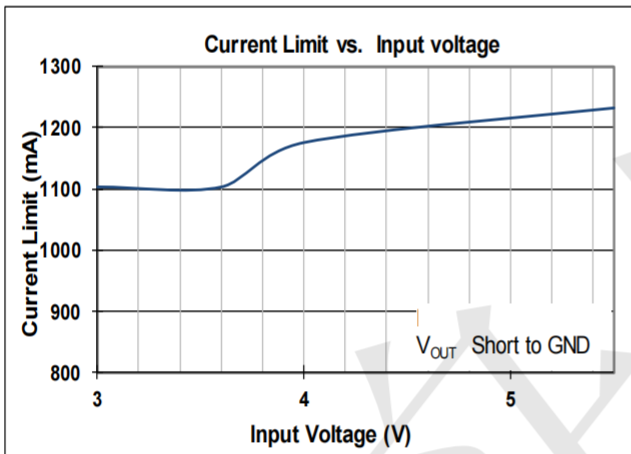

Fig. 10 Ground Current vs. Loading Current



Current Limit Response



Load Transient Response I

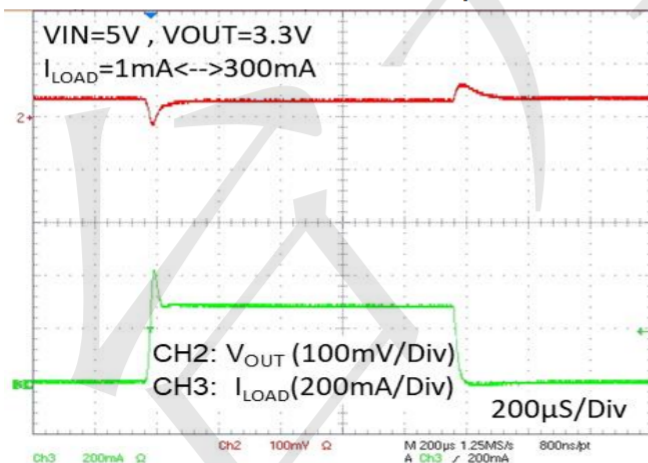

Load Transient Response II

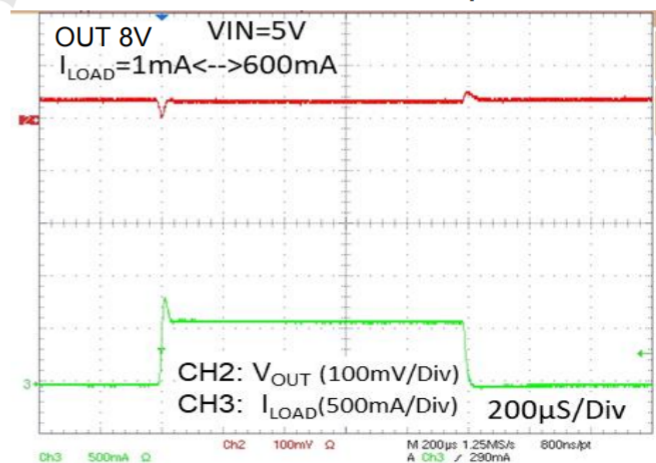

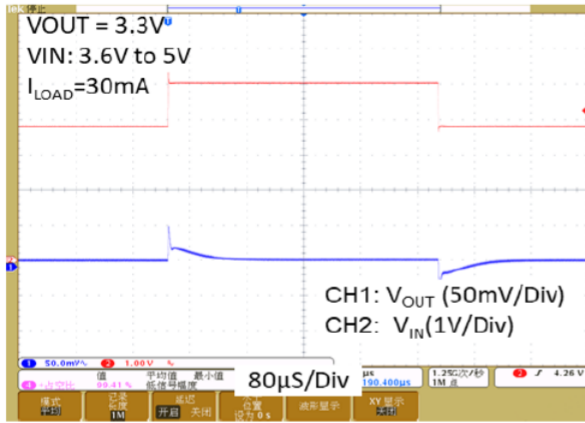

Fig. 17 Line Transient Response

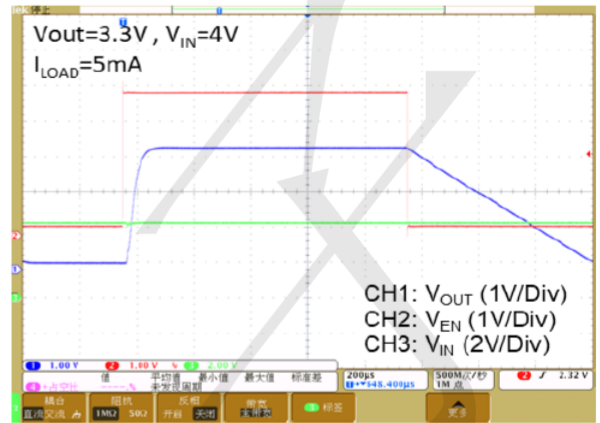
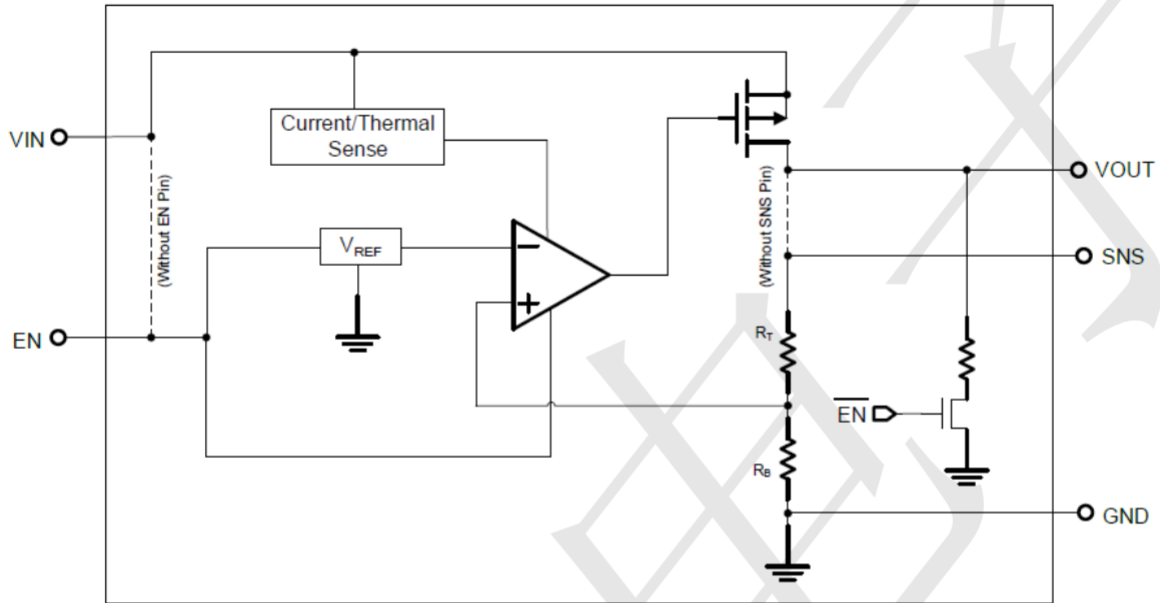

Fig. 18 V_{OUT} Turn On/Off by EN

BLOCK DIAGRAM



Package informantion

SOT23-5

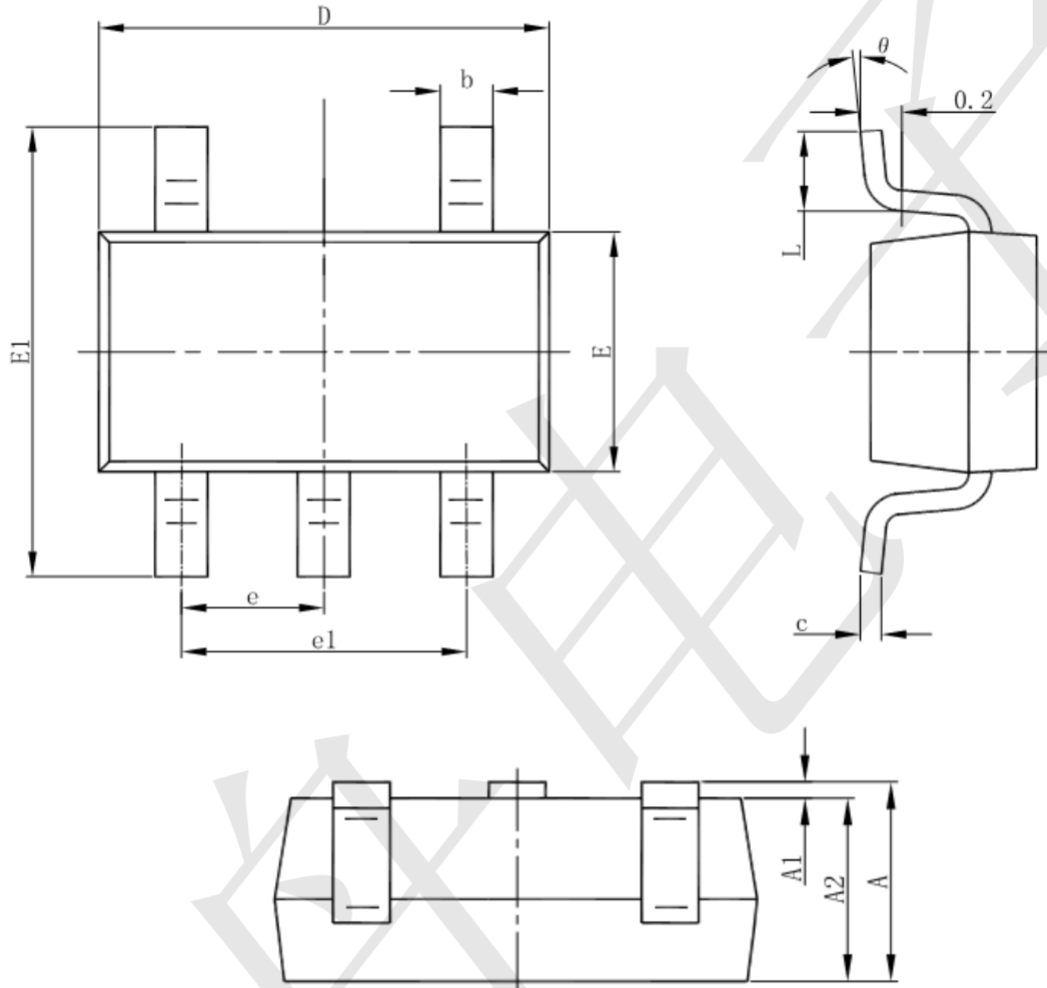

| Symbol | Dimensions In Millimeters | | Dimensions In Inches | |
|----------|---------------------------|-------|----------------------|-------|
| | Min | Max | Min | Max |
| A | 1.050 | 1.250 | 0.041 | 0.049 |
| A1 | 0.000 | 0.100 | 0.000 | 0.004 |
| A2 | 1.050 | 1.150 | 0.041 | 0.045 |
| b | 0.300 | 0.500 | 0.012 | 0.020 |
| c | 0.100 | 0.200 | 0.004 | 0.008 |
| D | 2.820 | 3.020 | 0.111 | 0.119 |
| E | 1.500 | 1.700 | 0.059 | 0.067 |
| E1 | 2.650 | 2.950 | 0.104 | 0.116 |
| e | 0.950(BSC) | | 0.037(BSC) | |
| e1 | 1.800 | 2.000 | 0.071 | 0.079 |
| L | 0.300 | 0.600 | 0.012 | 0.024 |
| θ | 0° | 8° | 0° | 8° |

X-ON Electronics

Largest Supplier of Electrical and Electronic Components

Click to view similar products for [LDO Voltage Regulators](#) category:

Click to view products by [TECH PUBLIC](#) manufacturer:

Other Similar products are found below :

[AP7363-SP-13](#) [NCV8664CST33T3G](#) [L79M05TL-E](#) [AP7362-HA-7](#) [PT7M8202B12TA5EX](#) [TCR3DF185,LM\(CT](#) [TLF4949EJ](#)
[NCP4687DH15T1G](#) [NCV8703MX30TCG](#) [LP2951CN](#) [NCV4269CPD50R2G](#) [AP7315-25W5-7](#) [NCV47411PAAJR2G](#) [AP2111H-1.2TRG1](#)
[ZLDO1117QK50TC](#) [AZ1117ID-ADJTRG1](#) [NCV4263-2CPD50R2G](#) [NCP114BMX075TCG](#) [MC33269T-3.5G](#) [TLE4471GXT](#) [AP7315-33SA-](#)
[7](#) [NCV4266-2CST33T3G](#) [NCP715SQ15T2G](#) [NCV8623MN-50R2G](#) [NCV563SQ18T1G](#) [NCV8664CDT33RKG](#) [NCV4299CD250R2G](#)
[NCV8702MX25TCG](#) [TLE7270-2E](#) [NCV562SQ25T1G](#) [AP2213D-3.3TRG1](#) [AP2202K-2.6TRE1](#) [NCV8170BMX300TCG](#)
[NCV8152MX300180TCG](#) [NCP700CMT45TBG](#) [AP7315-33W5-7](#) [NCP154MX180300TAG](#) [AP2210K-3.0TRE1](#) [AP2113AMTR-G1](#)
[NJW4104U2-33A-TE1](#) [MP2013AGG-5-P](#) [NCV8775CDT50RKG](#) [NJM2878F3-45-TE1](#) [S-19214B00A-V5T2U7](#) [S-19214B50A-V5T2U7](#) [S-](#)
[19213B50A-V5T2U7](#) [S-19214BC0A-E8T1U7*1](#) [S-19213B00A-V5T2U7](#) [S-19213B33A-V5T2U7](#) [S-19213BC0A-V5T2U7](#)