

Features

- Ultra low capacitance: 0.3pF typical (IO to IO)
- Ultra low leakage: nA level
- Low operating voltage: 5V
- Complies with following standards:
 - – IEC 61000-4-2 (ESD) immunity test
 - Air discharge: $\pm 20\text{kV}$
 - Contact discharge: $\pm 15\text{kV}$
 - – IEC 61000-4-5 (Lightning) 3.5A (8/20 μs)
- RoHS Compliant
- Lead Finish: NiPdAu

Mechanical Characteristics

- Package: DFN1210-6
- Lead Finish: Matte Tin
- Case Material: "Green" Molding Compound.
- Moisture Sensitivity: Level 3 per J-STD-020
- Terminal Connections: See Diagram Below
- Shipping Qty : 3000pcs/7Inch Tape & Reel

Applications

- USB
- MMC Port
- Serial ATA
- Video Port

Dimensions and Pin Configuration

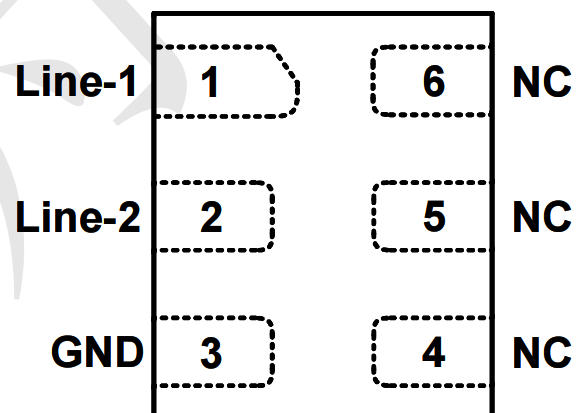
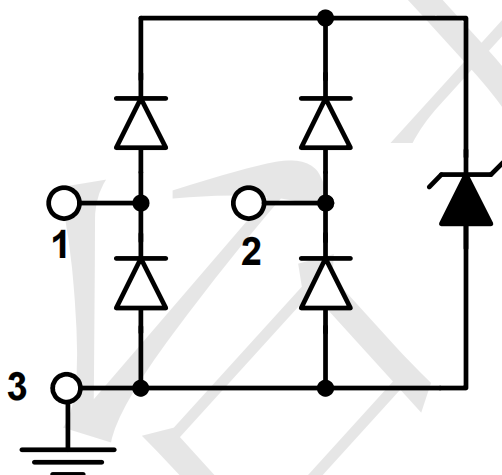

Marking: 9

Absolute Maximum Ratings (Tamb=25°C unless otherwise specified)

Parameter	Symbol	Value	Unit
Peak Pulse Power (8/20μs)	Ppk	55	W
Peak Pulse Current (8/20μs)	Ipp	3.5	A
ESD per IEC 61000-4-2 (Air)	VESD	±20	kV
ESD per IEC 61000-4-2 (Contact)		±15	
Operating Temperature Range	TJ	-55 to +125	°C
Storage Temperature Range	Tstg	-55 to +150	°C

Electrical Characteristics (TA=25°C unless otherwise specified)

Parameter	Symbol	Min	Typ	Max	Unit	Test Condition
Reverse Working Voltage	VRWM			5	V	
Breakdown Voltage	VBR	6			V	IT = 1mA
Reverse Leakage Current	IR			0.1	μA	VRWM = 5V
Clamping Voltage	VC			9	V	I _{PP} = 1A (8 x 20μs pulse)
Clamping Voltage	VC			15	V	I _{PP} = 3.5A (8 x 20Us pulse)
Junction Capacitance	CJ		0.5	0.6	pF	Vr=0V ,f= 1MHZ IO to GND
			0.3		pF	Vr=0V ,f= 1MHZ IO to IO

Typical Performance Characteristics ($T_A=25^\circ\text{C}$ unless otherwise Specified)

Fig1. 8/20 μs Pulse Waveform

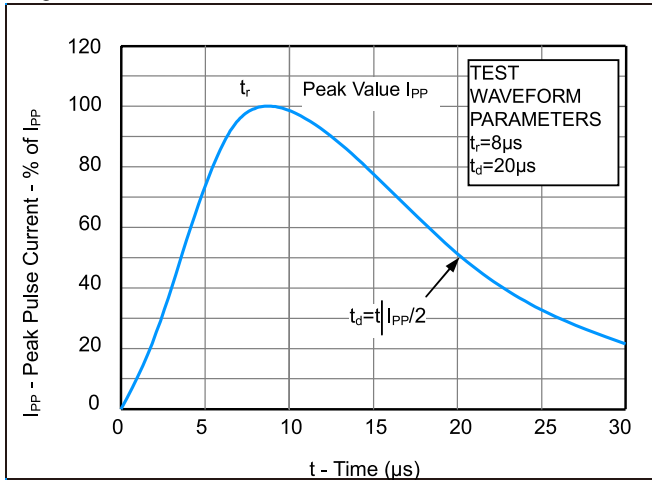

Fig2. ESD Pulse Waveform (according to IEC 61000-4-2)

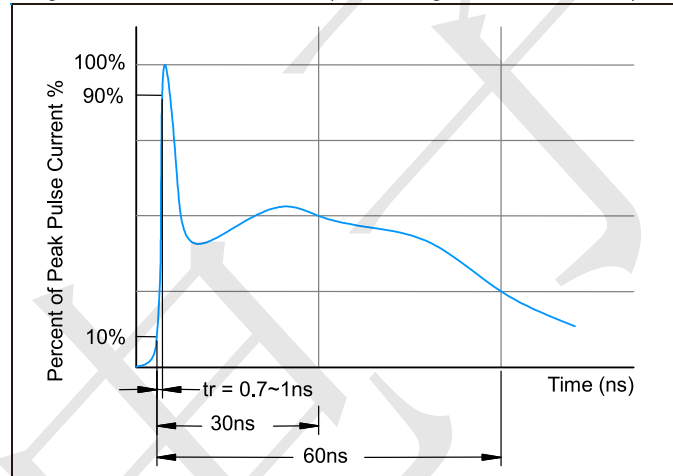
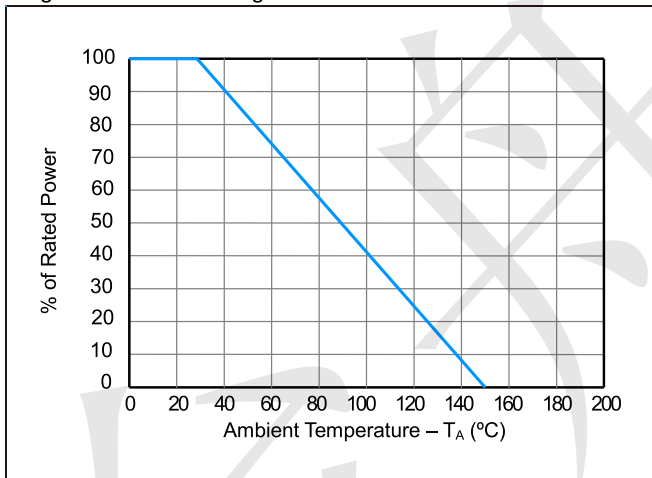
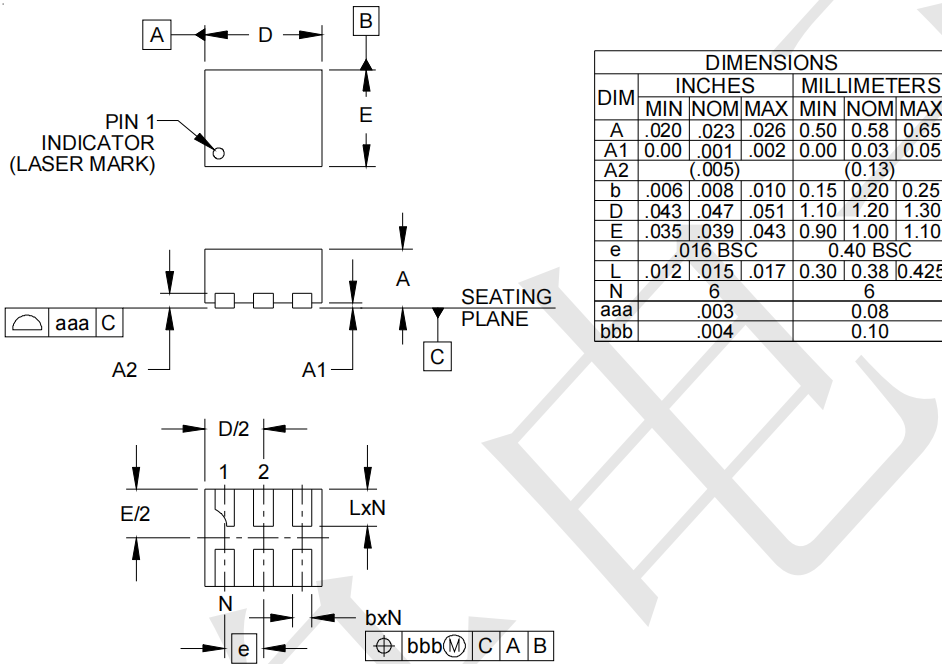

Fig3. Power Derating Curve



Outline Drawing - DFN1210-6



Land Pattern - DFN1210-6

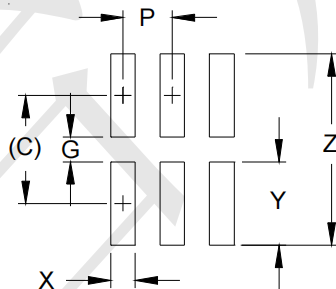

DIMENSIONS		
DIM	INCHES	MILLIMETERS
C	(.034)	(0.875)
G	.008	0.20
P	.016	0.40
X	.008	0.20
Y	.027	0.675
Z	.061	1.55

X-ON Electronics

Largest Supplier of Electrical and Electronic Components

Click to view similar products for [ESD Suppressors / TVS Diodes](#) category:

Click to view products by [TECH PUBLIC](#) manufacturer:

Other Similar products are found below :

[60KS200C](#) [D18V0L1B2LP-7B](#) [D5V0F4U5P5-7](#) [NTE4902](#) [P4KE27CA](#) [P6KE11CA](#) [P6KE8.2A](#) [JANTX1N6053A](#) [SA60CA](#) [SA64CA](#)
[SMBJ12CATR](#) [SMBJ33CATR](#) [SMBJ6.5A](#) [SMBJ8.0A](#) [ESD101-B1-02ELS E6327](#) [ESD112-B1-02EL E6327](#) [ESD7451N2T5G](#) [19180-510](#)
[CPDT-5V0USP-HF](#) [3.0SMCJ33CA-F](#) [3.0SMCJ36A-F](#) [HSPC16701B02TP](#) [JANTX1N6126A](#) [D3V3Q1B2DLP3-7](#) [D55V0M1B2WS-7](#)
[SCM1293A-04SO](#) [ESD200-B1-CSP0201 E6327](#) [SM12-7](#) [CEN955 W/DATA](#) [VESD12A1A-HD1-GS08](#) [CPDQC5V0-HF](#) [D1213A-01LP4-7B](#)
[ESD101-B1-02EL E6327](#) [AOZ8808DI-03](#) [5KP15A](#) [5KP48A](#) [5KP90A](#) [ESD3V3D7-TP](#) [15KPA36A-LF](#) [P4KE56CA](#) [P4KE68A](#)
[P4KE91CATR](#) [P6KE120A](#) [P6KE13CA](#) [P6KE43CA](#) [P6KE6.8CA](#) [P6KE8.2](#) [P6SMBJ20CA](#) [JANTX1N6072A](#) [SR2835ESKG](#)