

## Features

- Low on-resistance
- N-Channel MOSFET
- Low input capacitance
- Fast switching speed
- ESD Protection

## Shipping Quantity

- 3000pcs / Tape & Reel

## Typical Applications

- DC-DC converters
- Power management functions
- Battery operated systems and solid-state relays
- Drivers: Relays, Solenoids, Lamps, Hammers, Displays, Memories, Transistors, etc.

## Mechanical Data

- Case: SOT-23
- Molding Compound, UL Flammability Classification Rating 94V-0
- Terminals: Matte Tin Plated Leads, Solderable Per MIL-STD-202, Method 208

### SOT-23



1. GATE
2. SOURCE
3. DRAIN

## Circuit Diagram

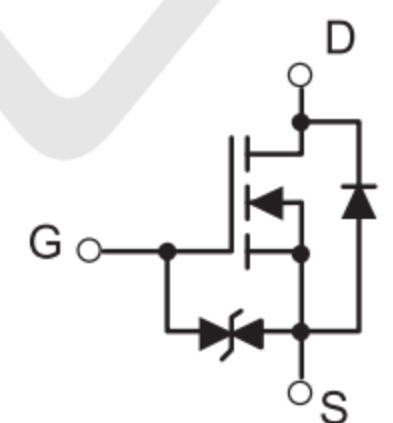

N-MOS

## Marking: J2x

“J2” is Part number ,Fixed

“x” is internal code

**Absolute Maximum Ratings** (T<sub>amb</sub>=25°C unless otherwise specified)

Parameter	Symbol	Value	Units
Drain-Source Voltage	V <sub>DSS</sub>	50	V
Gate -Source Voltage	V <sub>GSS</sub>	±20	V
Continuous Drain Current (T <sub>A</sub> = 25°C) *1	I <sub>D</sub>	360	mA
Pulsed Drain Current (t <sub>p</sub> = 10μs, T <sub>A</sub> = 25°C)	I <sub>DM</sub>	1500	mA
Single Pulse Avalanche Energy *2	E <sub>AS</sub>	0.2	mJ
Power Dissipation	P <sub>D</sub>	0.35	W
	SOT-23		



**Thermal Characteristics**

Parameter	Symbol	Limits	Unit
Thermal Resistance Junction to Ambient Air	$R_{\theta JA}$	370	°C/W
Thermal Resistance Junction to Lead	$R_{\theta JL}$	222	
Thermal Resistance Junction to Case	$R_{\theta JC}$	187	
Operating Junction Temperature Range	$T_J$	-55 to +150	°C
Storage Temperature Range	$T_{STG}$	-55 to +150	°C

**Electrical Characteristics** ( $T_A=25^\circ\text{C}$  unless otherwise specified)

Symbol	Parameter	Test conditions	MIN	TYP	MAX	UNIT
<b>OFF Characteristics</b>						
$V_{DSS}$	Drain-Source Breakdown Voltage	$V_{GS} = 0V, I_D = 250\mu A$	50	-	-	V
$I_{DSS}$	Drain to Source Leakage Current	$V_{DS} = 50V, V_{GS} = 0V$	-	-	1	$\mu A$
$I_{GSS}$	Gate-body Leakage	$V_{GS} = \pm 20V, V_{DS} = 0V$	-	-	$\pm 10$	$\mu A$
<b>ON Characteristics</b>						
$R_{DS(ON)}$	Drain-Source On-resistance *1	$V_{GS} = 10V, I_D = 0.5A$	-	1.5	2.0	$\Omega$
		$V_{GS} = 4.5V, I_D = 0.2A$	-	1.7	2.5	
		$V_{GS} = 2.5V, I_D = 0.1A$	-	2.0	4.5	
$V_{GS(TH)}$	Gate Threshold Voltage	$V_{DS} = V_{GS}, I_D = 250\mu A$	0.8	1	1.5	V
$R_G$	Gate Resistance	$V_{GS} = 0V, f = 1MHz$	-	48	-	$\Omega$
<b>Dynamic Characteristics</b>						
$C_{ISS}$	Input Capacitance	$V_{GS} = 0V$	-	32	-	pF
$C_{OSS}$	Output Capacitance	$V_{DS} = 25V$	-	6	-	
$C_{RSS}$	Reverse Transfer Capacitance	$f = 1.0MHz$	-	3	-	
<b>Switching Characteristics</b>						
$t_{d(on)}$	Turn-on Delay Time *3	$V_{DD} = 25V, I_D = 0.36A$ $V_{GS} = 10V, R_G = 6\Omega$	-	2.2	-	nS
$t_r$	Turn-on Rise Time *3		-	19.2	-	
$t_{d(off)}$	Turn-Off Delay Time *3		-	6.2	-	
$t_f$	Turn-Off Fall Time *3		-	23	-	
$Q_G$	Total Gate-Charge	$V_{DS} = 25V$	-	4	-	nC
$Q_{GS}$	Gate to Source Charge	$V_{GS} = 10V$	-	0.5	-	nC
$Q_{GD}$	Gate to Drain (Miller) Charge	$I_D = 0.2A$	-	0.4	-	nC
<b>Source-Drain Diode Characteristics</b>						
$V_{SD}$	Diode Forward Voltage *2	$I_S = 0.5A, V_{GS} = 0V$	-	0.89	1.4	V
$t_{rr}$	Reverse Recovery Time	$I_F = 1A, V_{GS} = 0V$	-	15	-	ns
$Q_{rr}$	Reverse Recovery Charge	$dI_F/dt = 100A/\mu s$	-	8	-	nC





Typical Performance Characteristics ( $T_A=25^\circ\text{C}$  unless otherwise Specified)

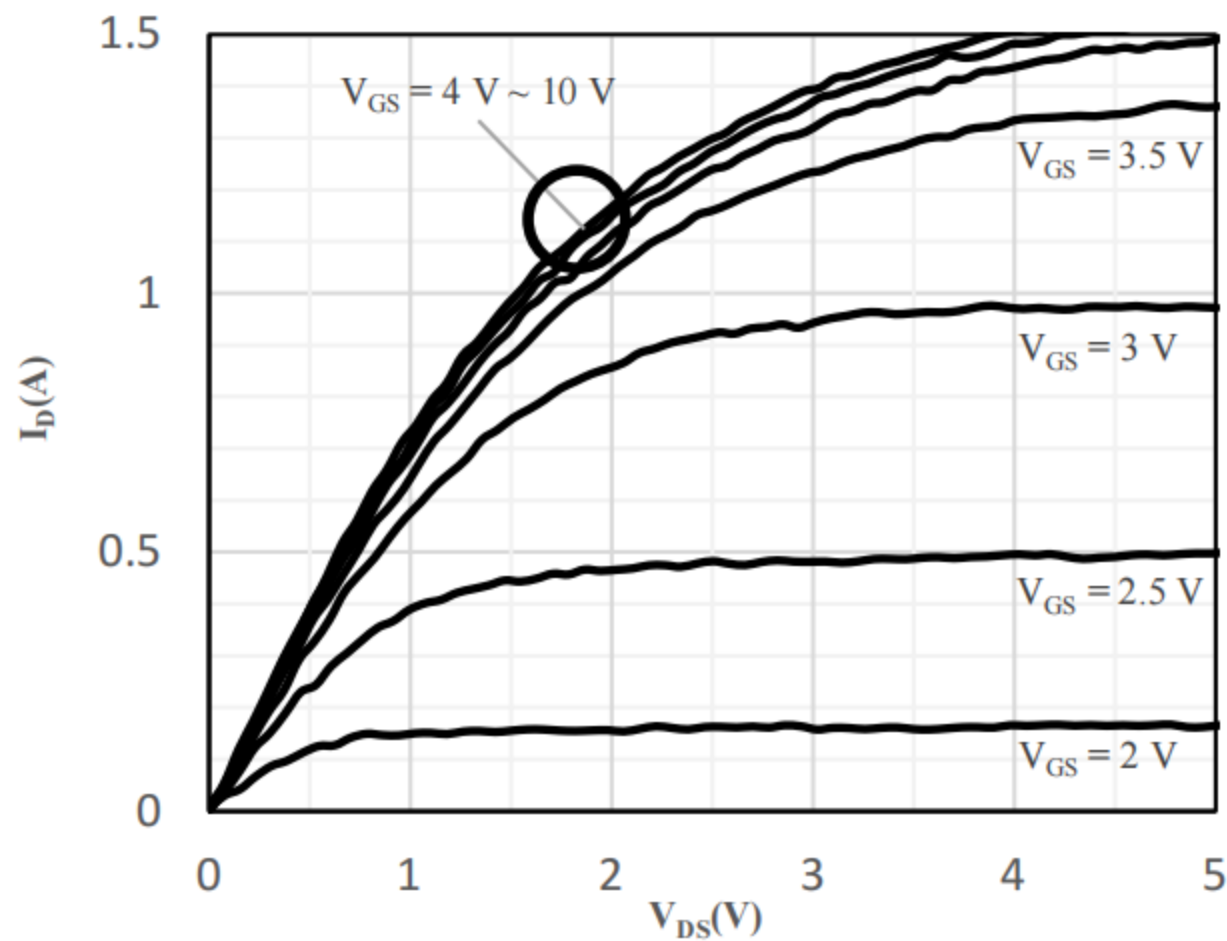

Fig 1 Typical Output Characteristics

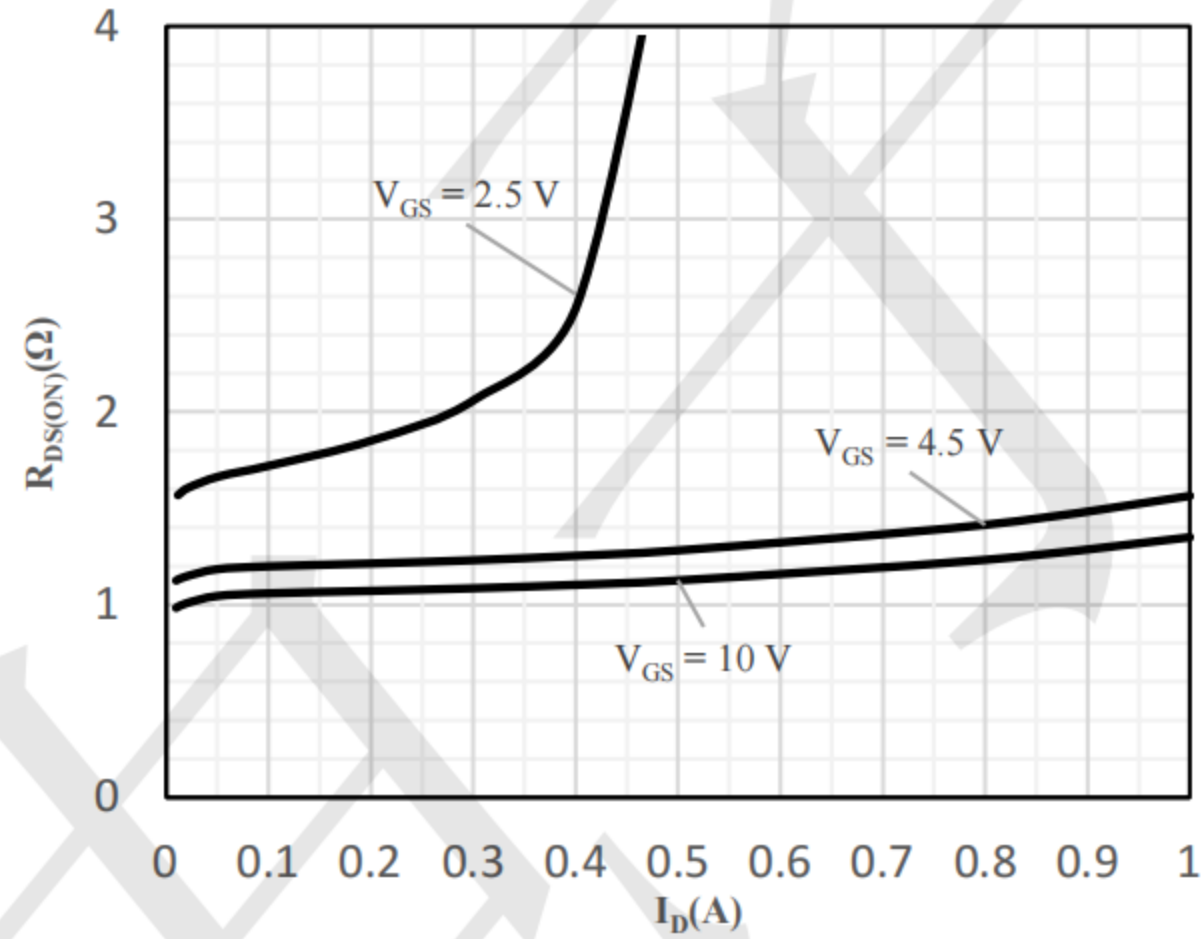

Fig 2 On-Resistance vs. Drain Current and Gate Voltage

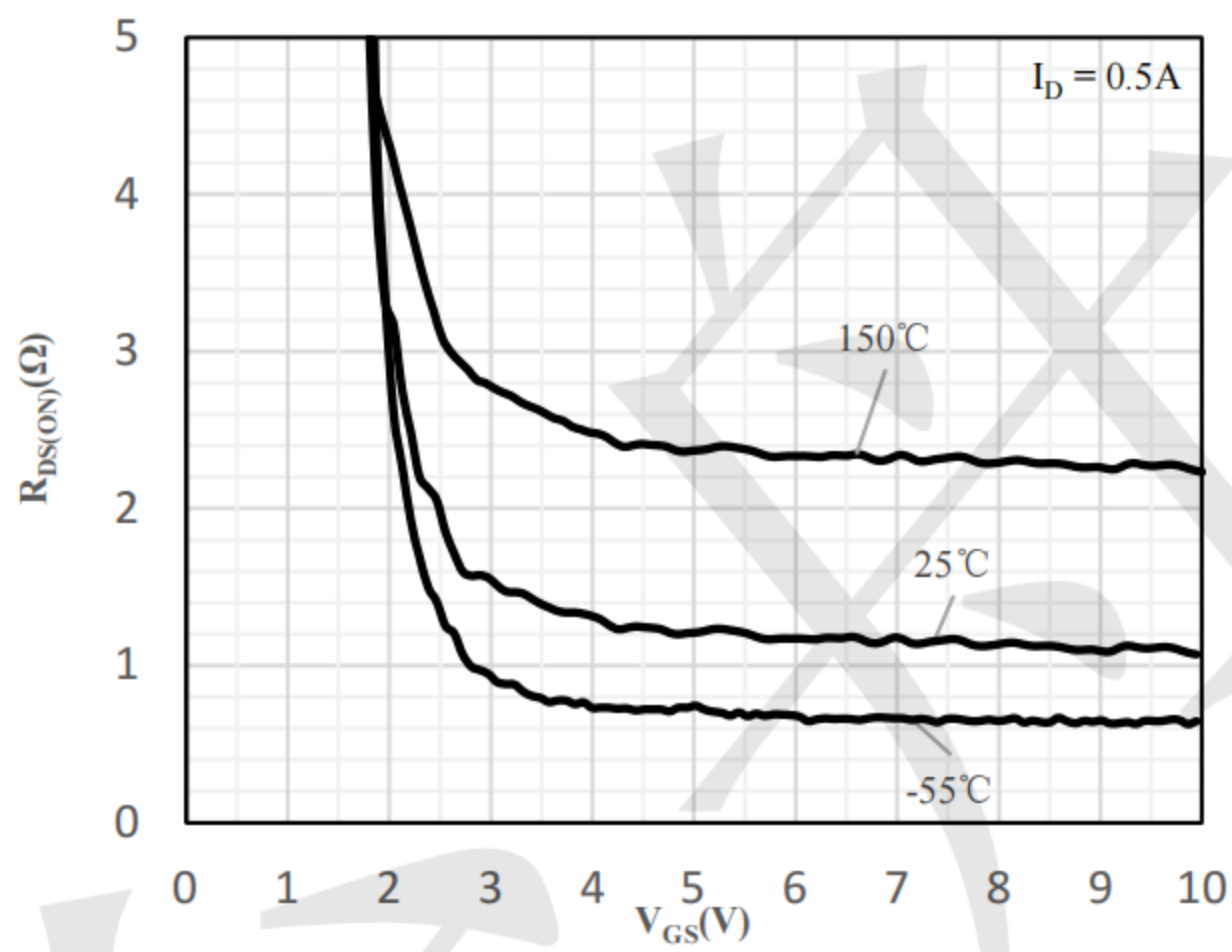

Fig 3 On-Resistance vs. Gate-Source Voltage

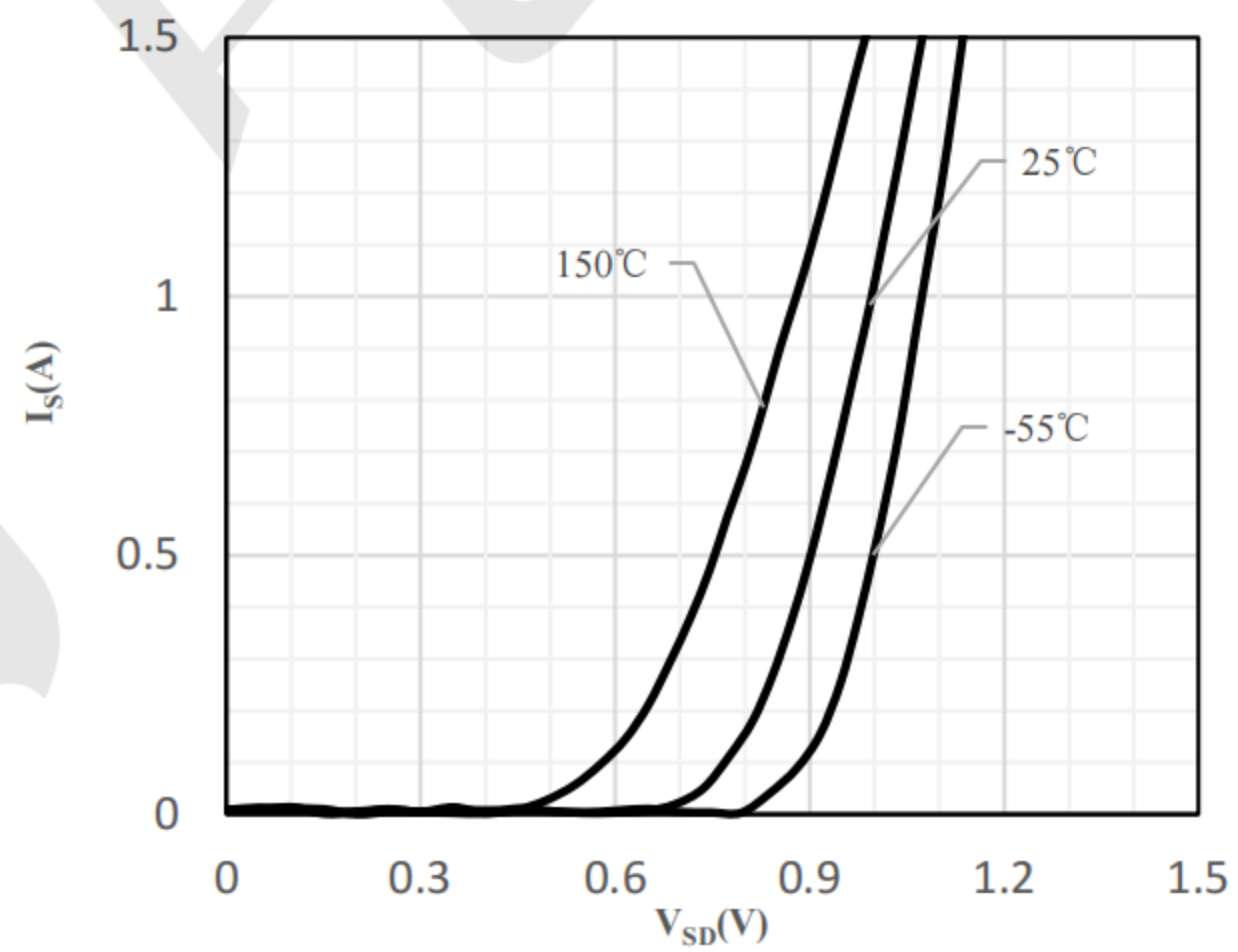

Fig 4 Body-Diode Characteristics

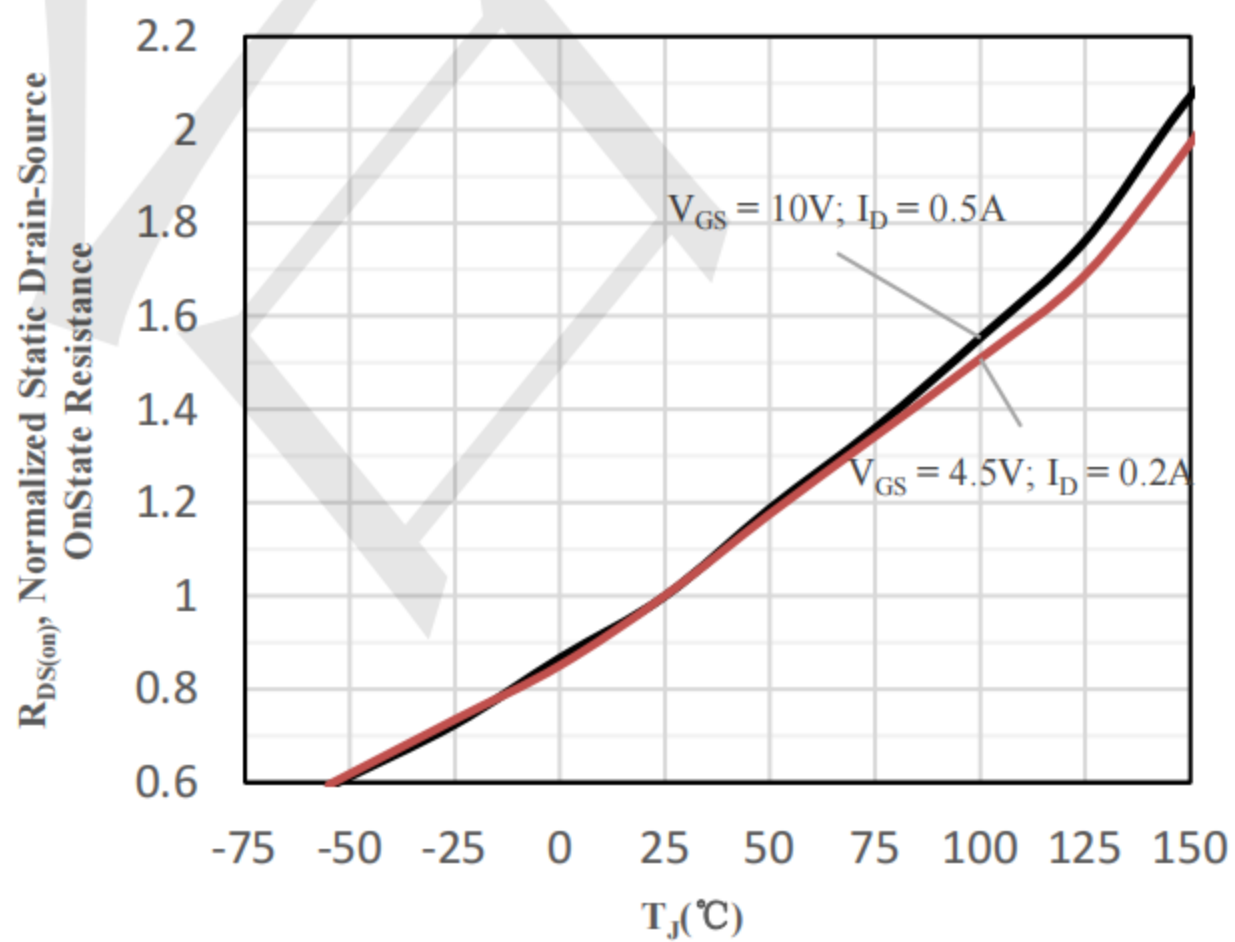

Fig 5 Normalized On-Resistance vs. Junction

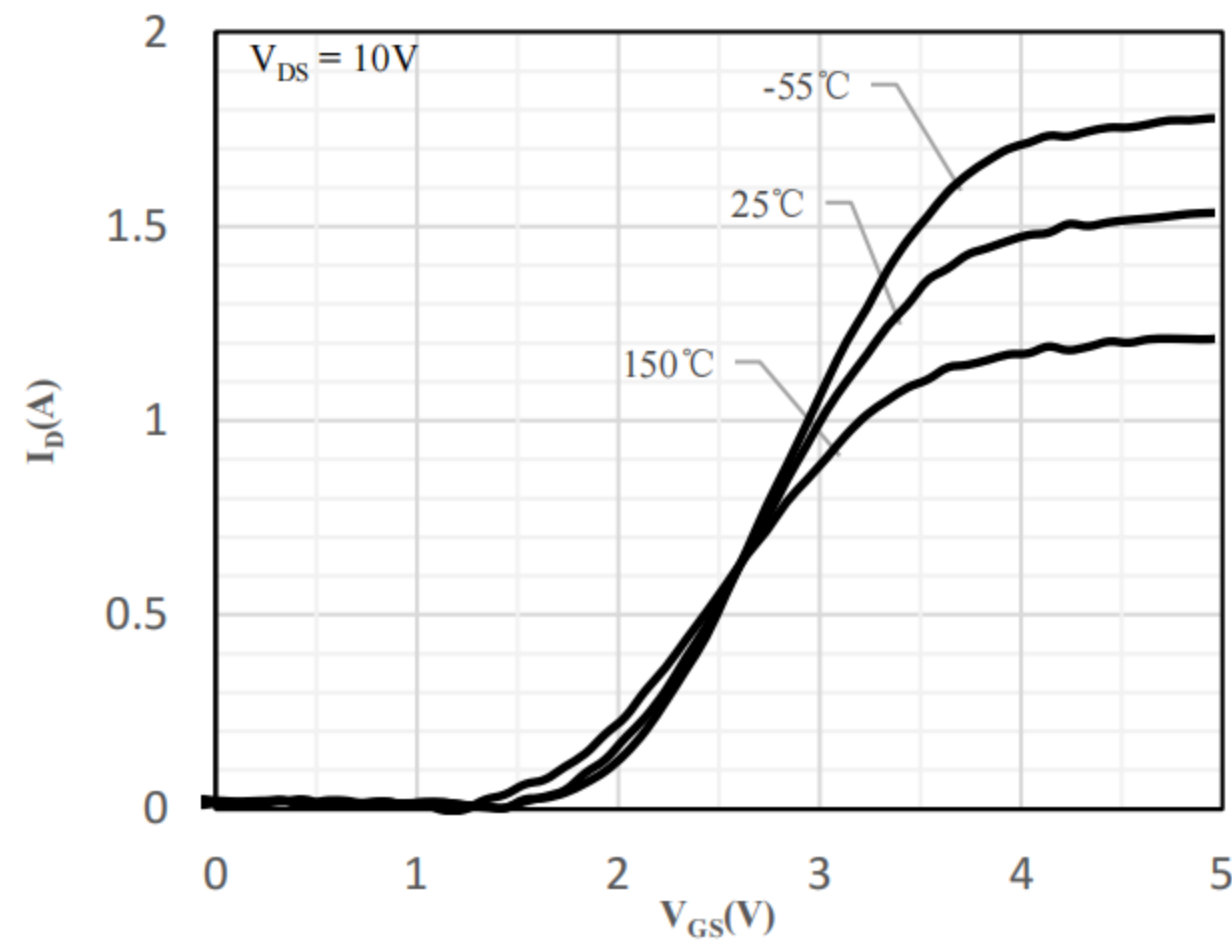

Fig 6 Transfer Characteristics



Typical Performance Characteristics ( $T_A=25^\circ\text{C}$  unless otherwise Specified)

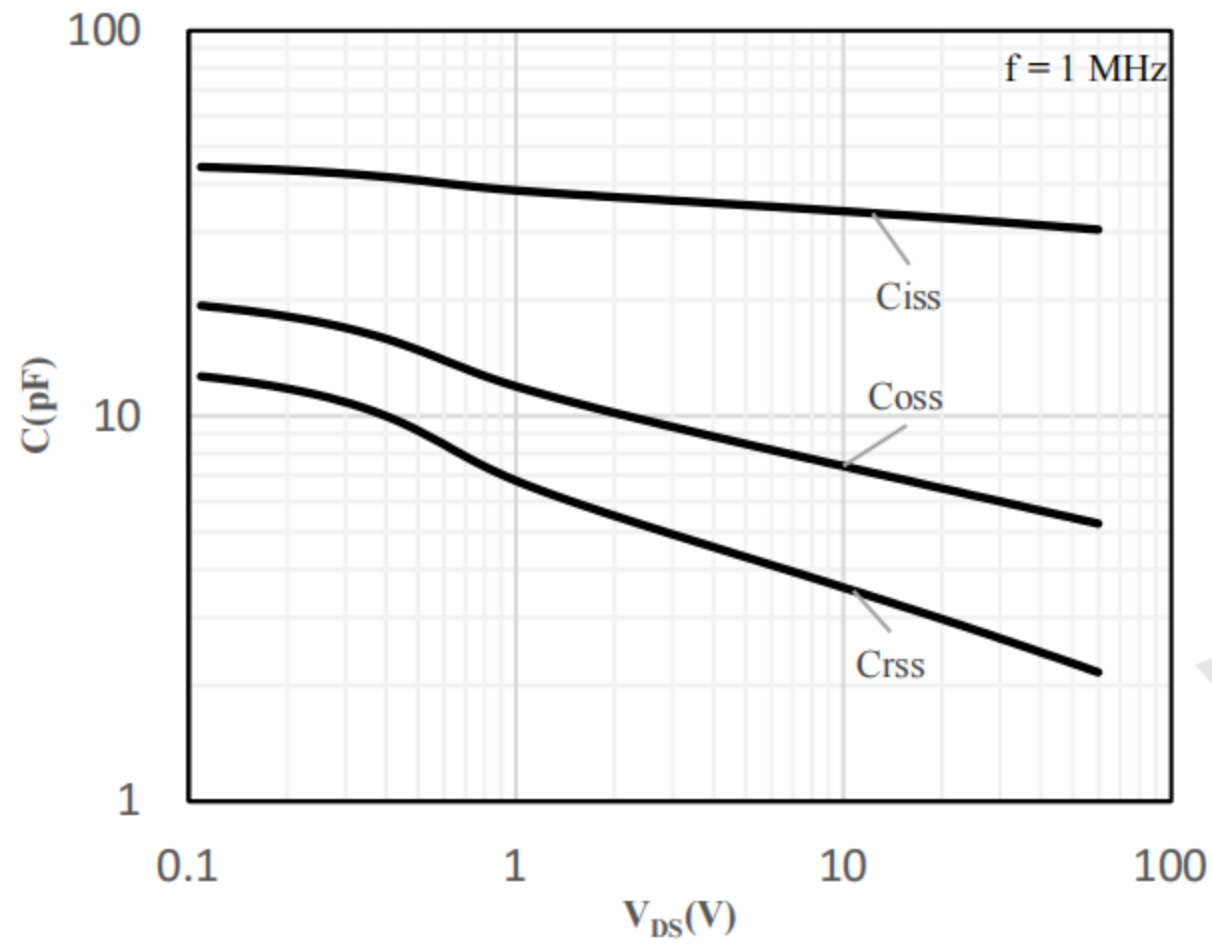

Fig 7 Capacitance Characteristics

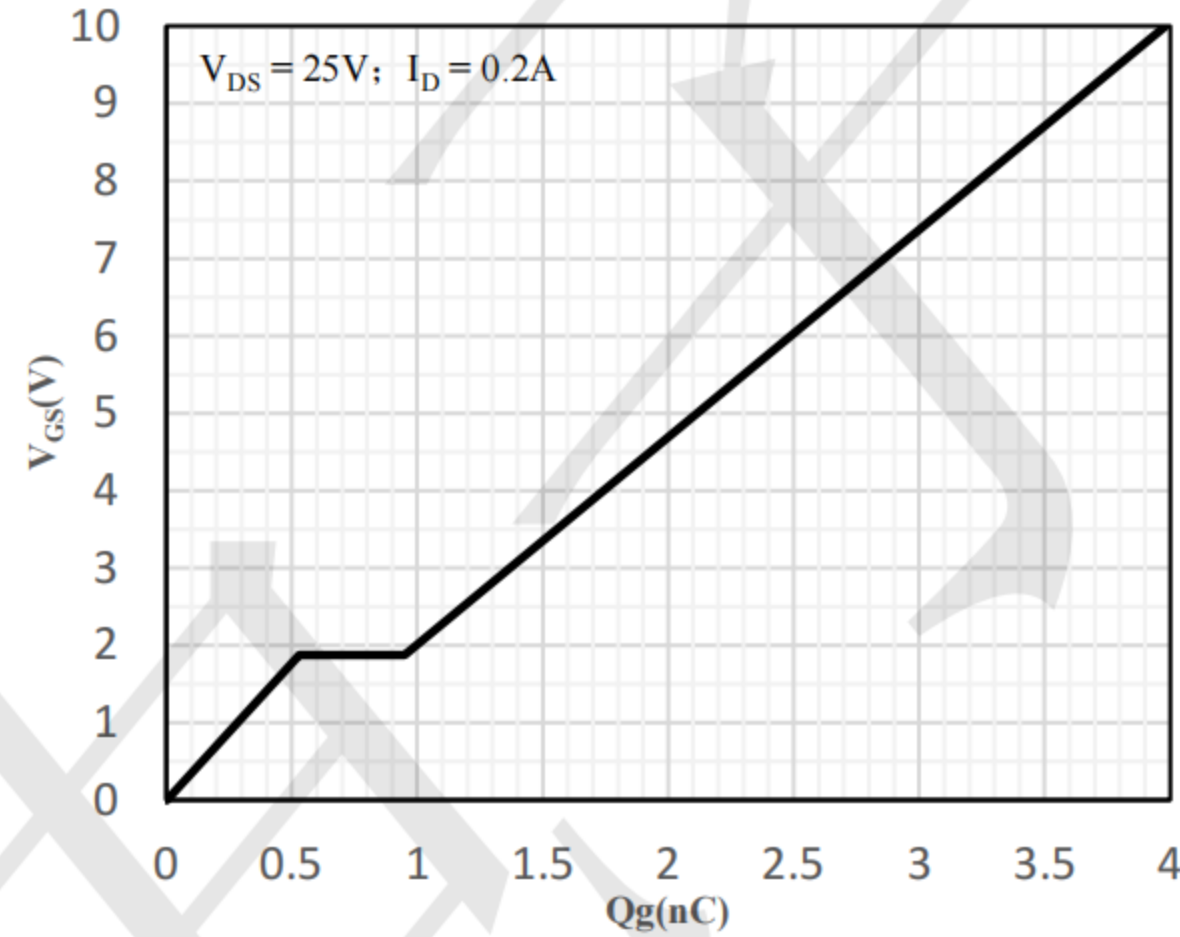

Fig 8 Gate-Charge Characteristics

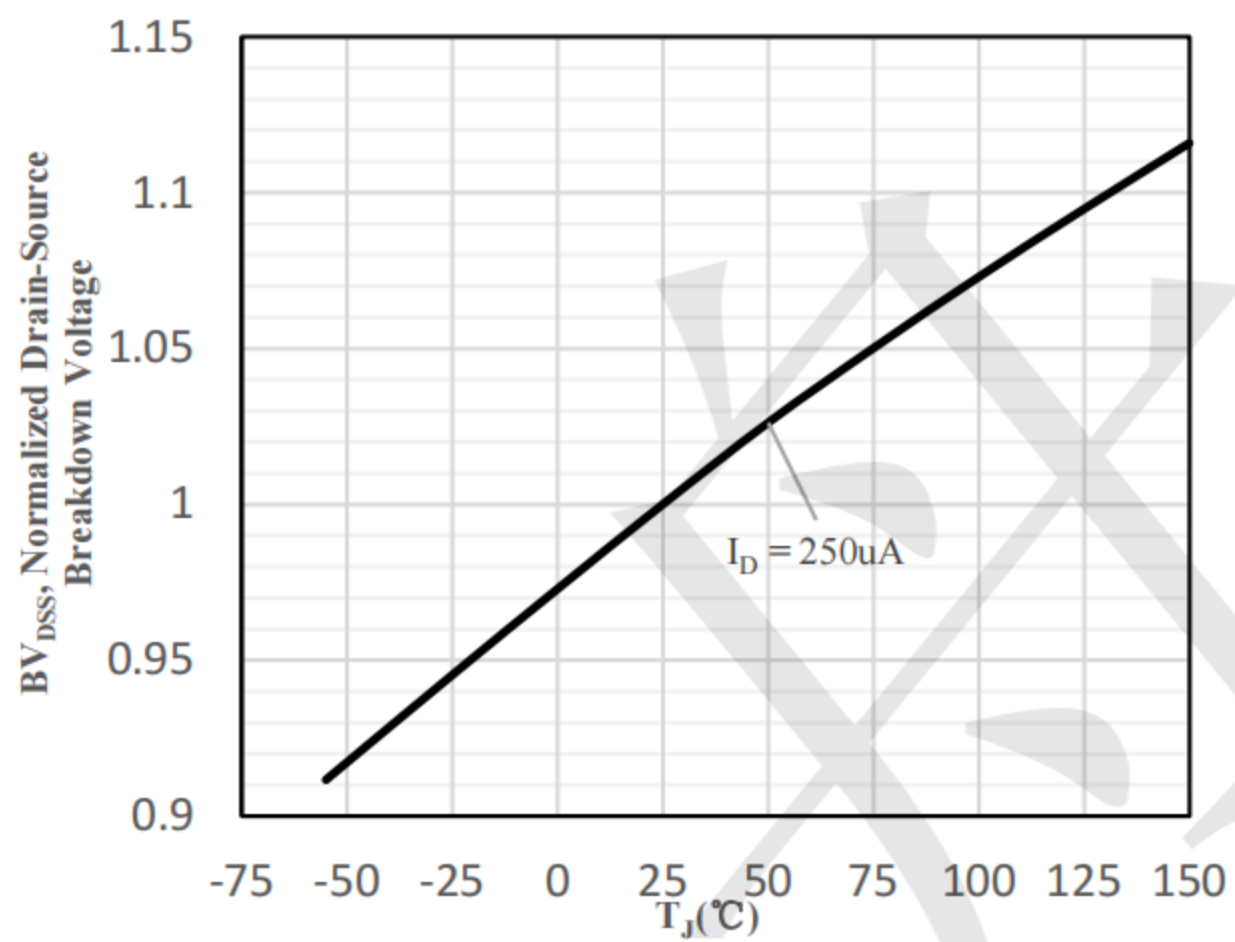

Fig 9 Normalized Breakdown Voltage vs. Junction Temperature

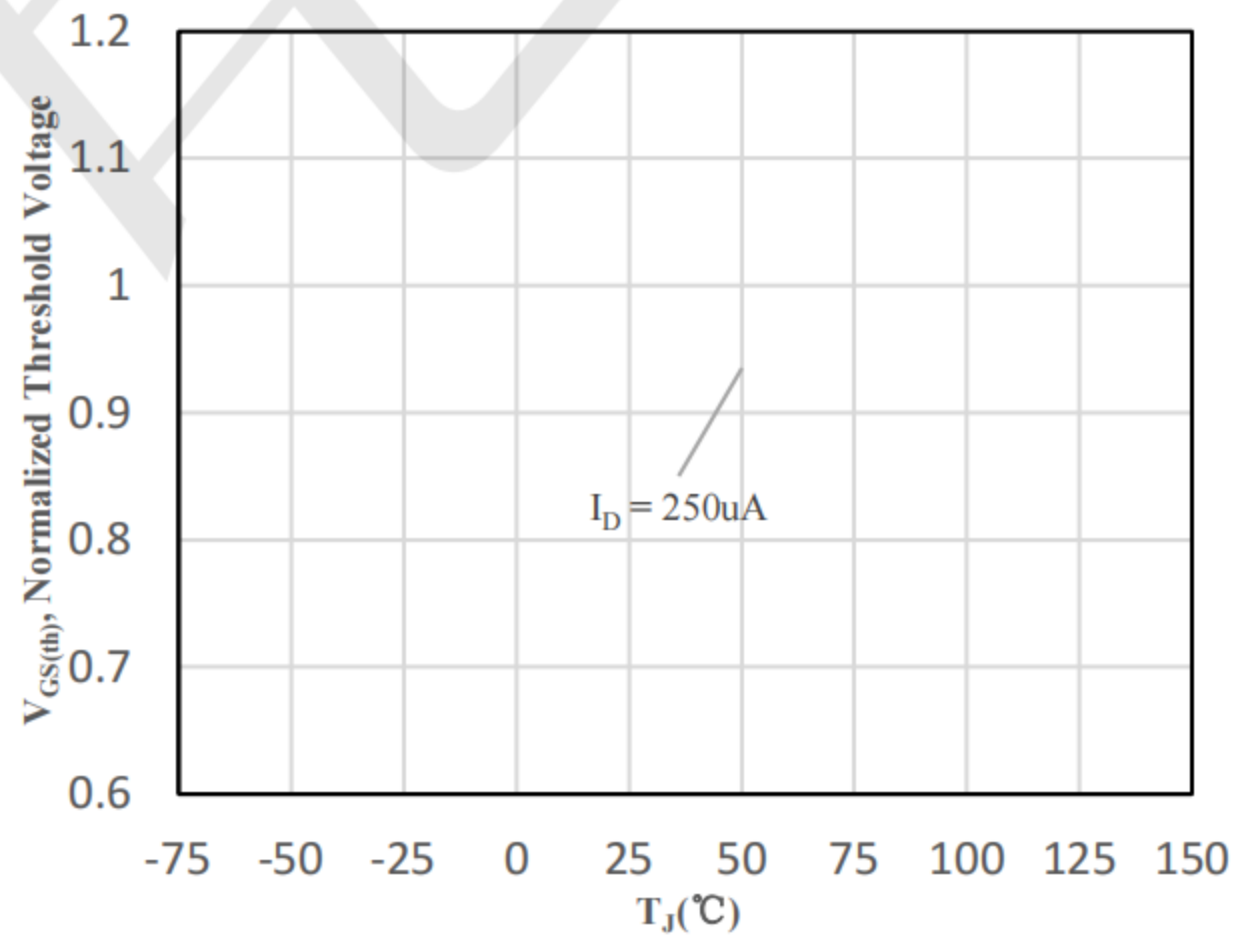

Fig 10 Normalized  $V_{GS(th)}$  vs. Junction Temperature

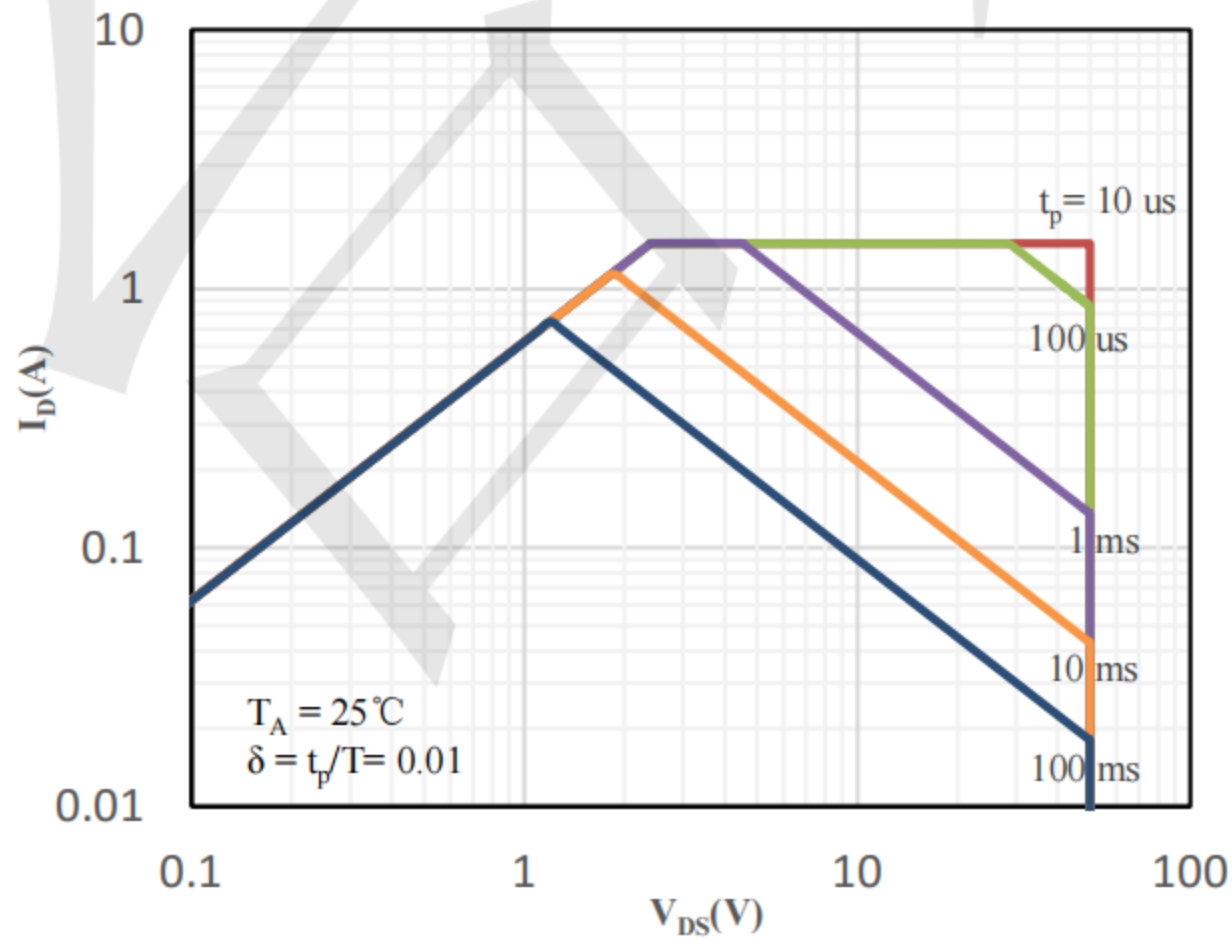

Fig 11 Safe Operation Area

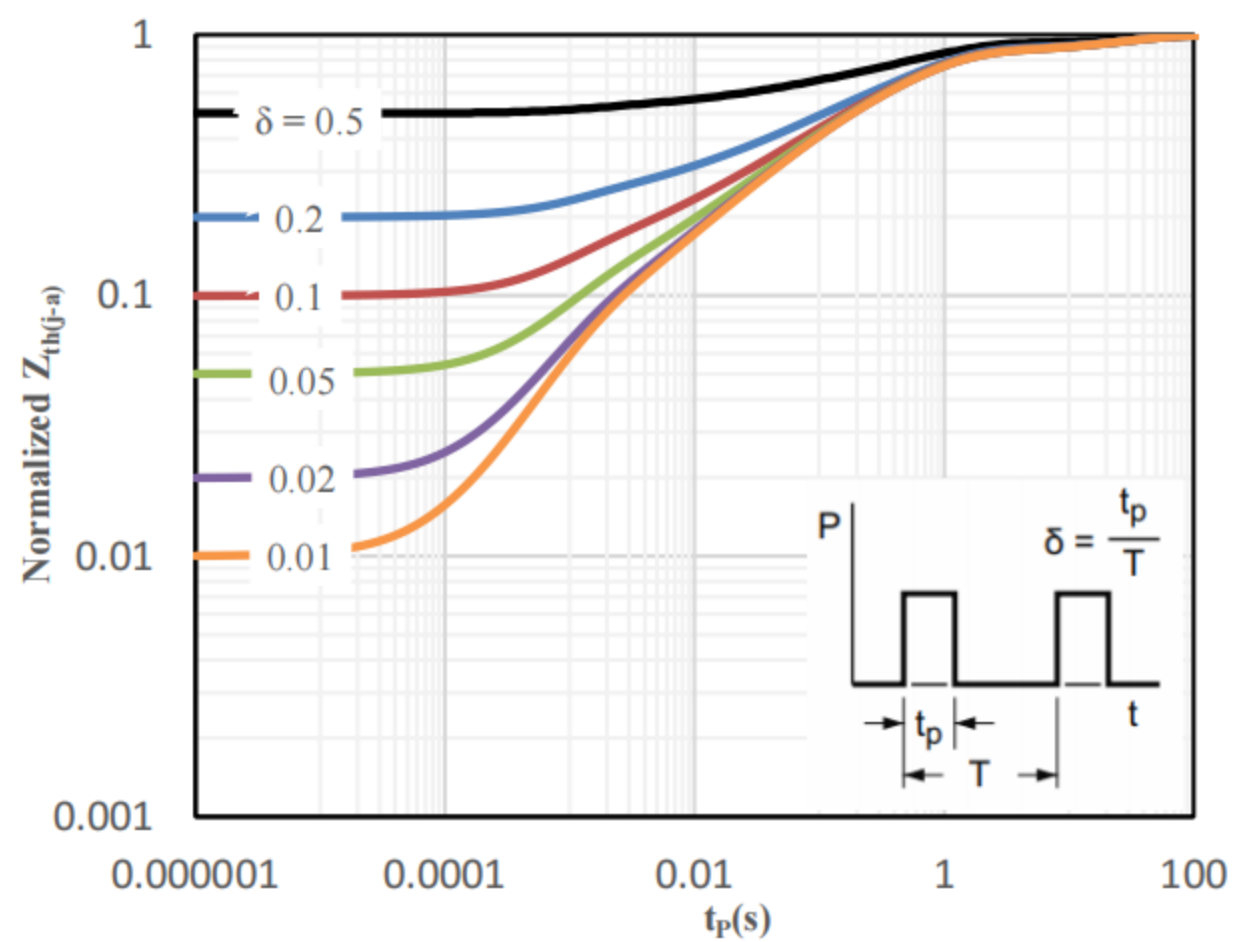
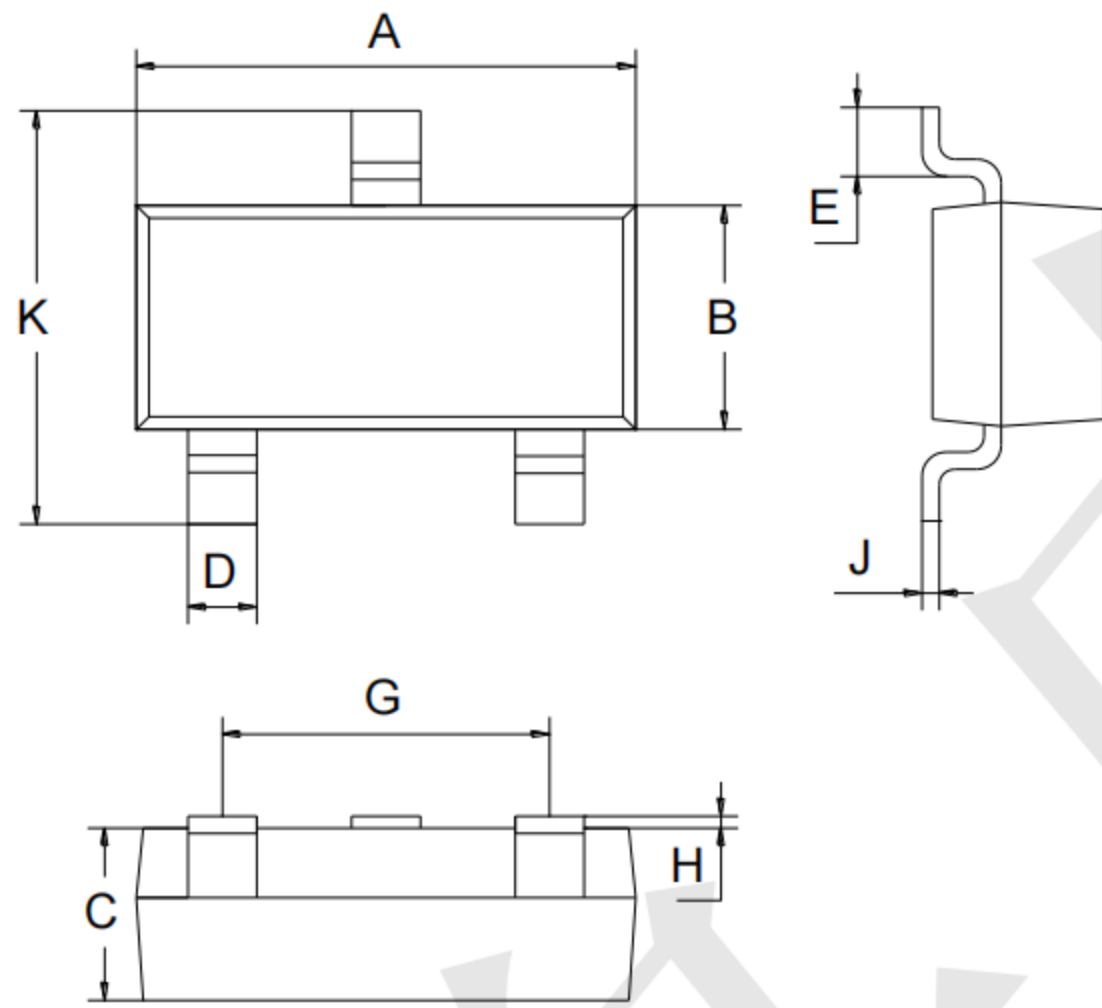

Fig 12 Normalized Maximum transient thermal impedance



**Outline Drawing - SOT23**



SOT-23		
Dimension	Min.	Max.
A	2.70	3.10
B	1.10	1.50
C	0.90	1.10
D	0.30	0.50
E	0.35	0.48
G	1.80	2.00
H	0.02	0.10
J	0.05	0.15
K	2.20	2.60

**Land Pattern - SOT23**

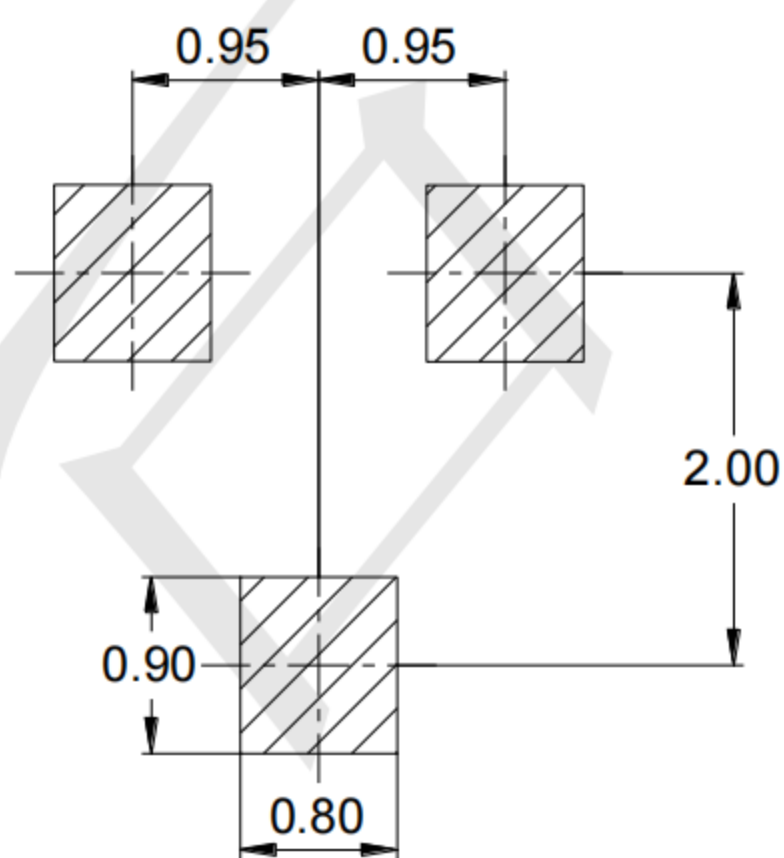



## X-ON Electronics

Largest Supplier of Electrical and Electronic Components

*Click to view similar products for [MOSFET](#) category:*

*Click to view products by [TECH PUBLIC](#) manufacturer:*

Other Similar products are found below :

[IRFD120](#) [JANTX2N5237](#) [2SK2267\(Q\)](#) [BUK455-60A/B](#) [TK100A10N1,S4X\(S](#) [MIC4420CM-TR](#) [VN1206L](#) [NDP4060](#) [SI4482DY](#)  
[IRS2092STRPBF-EL](#) [IPS70R2K0CEAKMA1](#) [TK31J60W5,S1VQ\(O](#) [TK31J60W,S1VQ\(O](#) [TK16J60W,S1VQ\(O](#) [2SK2614\(TE16L1,Q\)](#)  
[DMN1017UCP3-7](#) [EFC2J004NUZTDG](#) [P85W28HP2F-7071](#) [DMN1053UCP4-7](#) [NTE2384](#) [DMC2700UDMQ-7](#) [DMN2080UCB4-7](#)  
[DMN61D9UWQ-13](#) [US6M2GTR](#) [DMN31D5UDJ-7](#) [DMP22D4UFO-7B](#) [IPS60R3K4CEAKMA1](#) [DMN1006UCA6-7](#) [DMN16M9UCA6-7](#)  
[STF5N65M6](#) [IRF40H233XTMA1](#) [STU5N65M6](#) [DMN6022SSD-13](#) [DMN13M9UCA6-7](#) [DMTH10H4M6SPS-13](#) [IPS60R360PFD7SAKMA1](#)  
[DMN2990UFB-7B](#) [SSM3K35CT,L3F](#) [IPLK60R1K0PFD7ATMA1](#) [2N7002W-G](#) [MCAC30N06Y-TP](#) [IPWS65R035CFD7AXKSA1](#)  
[MCQ7328-TP](#) [SSM3J143TU,LXHF](#) [PJMF280N65E1\\_T0\\_00201](#) [PJMF380N65E1\\_T0\\_00201](#) [PJMF280N60E1\\_T0\\_00201](#)  
[PJMF600N65E1\\_T0\\_00201](#) [PJMF900N65E1\\_T0\\_00201](#) [PJMF900N60E1\\_T0\\_00201](#)