

### Product Summary

- $V_{DS} = -50V, I_D = -0.13A$   
 $R_{DS(ON)} < 10 \Omega @ V_{GS} = -5V$

### Application

- Load/Power Switching
- Interfacing Switching
- Logic Level Shift

### Package and Pin Configuration

SOT-323



### Circuit diagram

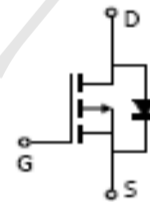

### Marking:PD

### Absolute Maximum Ratings ( $T_A = 25^\circ C$ unless otherwise noted)

Symbol	Parameter	Value	Units
$V_{DSS}$	Drain-Source voltage	-50	V
$V_{DGR}$	Drain-Gate voltage	-50	V
$V_{GSS}$	Gate -Source voltage	continuous $\pm 20$	V
$I_D$	Drain current (Note1)	continuous -130	mA
$P_D$	Power Dissipation (Note1)	200	mW
$R_{\theta JA}$	Thermal resistance, Junction-to-Ambient	625	$^\circ C/W$
$T_J, T_{stg}$	Junction and Storage Temperature	-55 to +150	$^\circ C$

**Electrical Characteristics (  $T_A = 25^\circ\text{C}$  unless otherwise noted )**

Parameter	Symbol	Test conditions	MIN	TYP	MAX	UNIT
Drain-Source Breakdown Voltage	$V_{(BR)DSS}$	$V_{GS}=0V, I_D=-250\mu A$	-50	-75	-	V
Gate Threshold Voltage	$V_{GS(th)}$	$V_{DS}=V_{GS}, I_D=-1mA$	-0.8	-1.6	-2.0	
Gate-body Leakage	$I_{GSS}$	Forward $V_{DS}=0V, V_{GS}=20V$	-	-	100	nA
		Reverse $V_{DS}=0V, V_{GS}=-20V$	-	-	-100	
Zero Gate Voltage Drain Current	$I_{DSS}$	$V_{DS}=-50V, V_{GS}=0V, T_J = 25^\circ\text{C}$	-	-	-15	$\mu A$
		$V_{DS}=-50V, V_{GS}=0V, T_J = 125^\circ\text{C}$			-60	
		$V_{DS}=-25V, V_{GS}=0V, T_J = 25^\circ\text{C}$	-	-	-100	
Forward transconductance	$g_{FS}$	$V_{DS}=-25V, I_D=100mA$	50	-	-	mS
Static drain-Source on-resistance	$R_{DS(ON)}$	$V_{GS}=-5.0V, I_D=100mA$	-	6	10	$\Omega$
Input capacitance	$C_{ISS}$	$V_{DS}=-25V, V_{GS}=0V, f=1.0MHz$	-	-	45	$\mu F$
Output capacitance	$C_{OSS}$		-	-	25	
Reverse transfer capacitance	$C_{RSS}$		-	-	12	
Turn-On Delay Time	$t_{D(ON)}$	$V_{DD} = -30V, I_D = -0.27A,$	-	10	-	ns
Turn-Off Delay Time	$t_{D(OFF)}$	$V_{GS} = -10V, R_{GEN} = 50\Omega$	-	18	-	ns



### Characteristic Curves

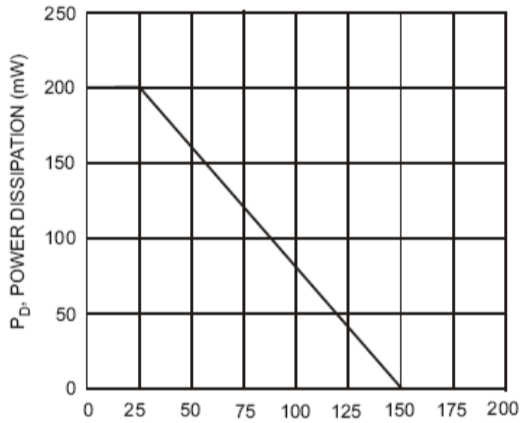

Fig. 1, Max Power Dissipation vs Ambient Temperature

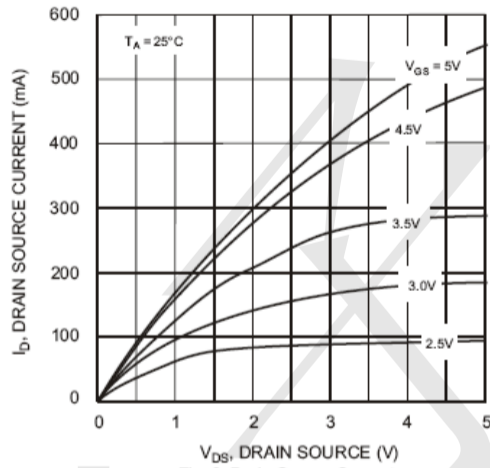

Fig. 2, Drain Source Current vs. Drain Source Voltage

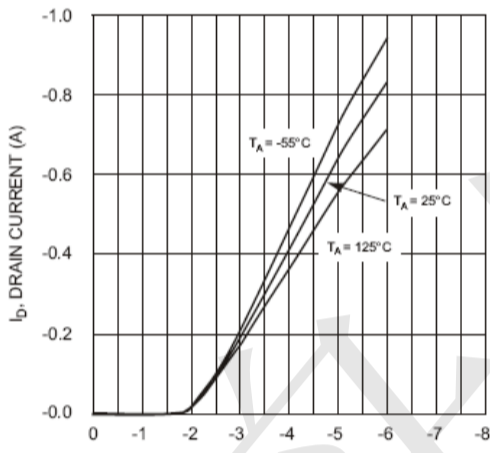

Fig. 3, Drain Current vs. Gate Source Voltage

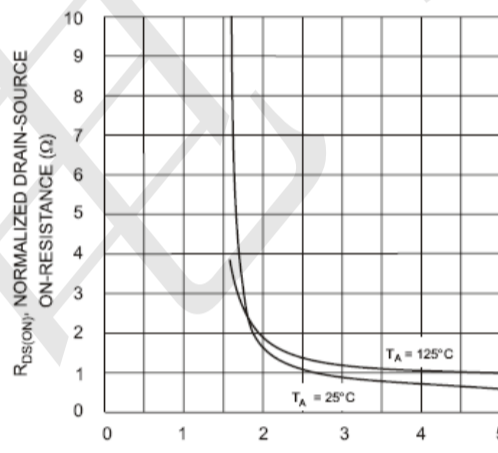

Fig. 4, On Resistance vs. Gate Source Voltage

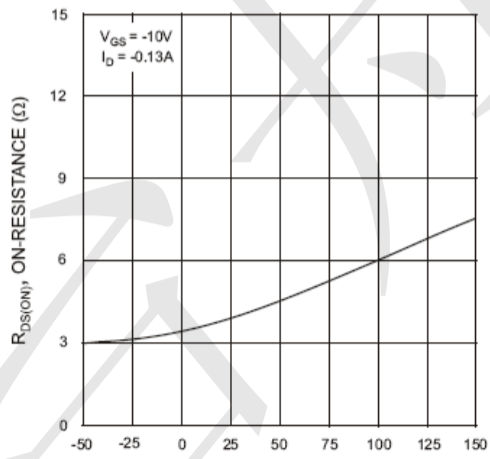

Fig. 5, On-Resistance vs. Junction Temperature

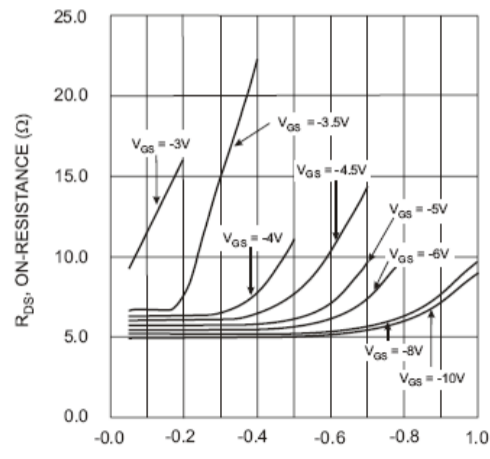
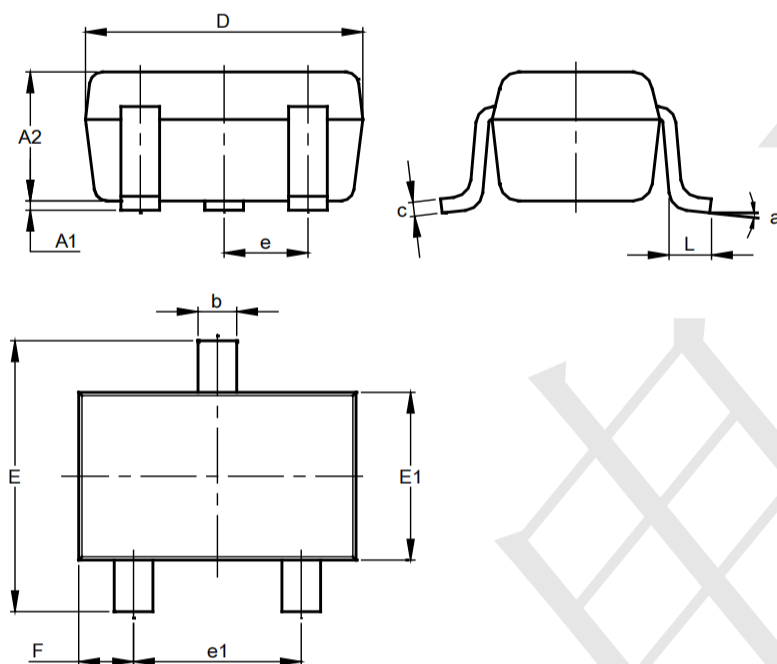

Fig. 6, On-Resistance vs. Drain Current



Outline Drawing - SOT323(SC70-3)



SOT323			
Dim	Min	Max	Typ
A1	0.00	0.10	0.05
A2	0.90	1.00	0.95
b	0.25	0.40	0.30
c	0.10	0.18	0.11
D	1.80	2.20	2.15
E	2.00	2.20	2.10
E1	1.15	1.35	1.30
e	0.650 BSC		
e1	1.20	1.40	1.30
F	0.375	0.475	0.425
L	0.25	0.40	0.30
a	0°	8°	--
All Dimensions in mm			

Land Pattern - SOT323

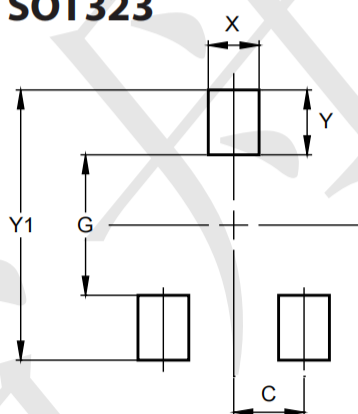

Dimensions	Value (in mm)
C	0.650
G	1.300
X	0.470
Y	0.600
Y1	2.500

## X-ON Electronics

Largest Supplier of Electrical and Electronic Components

*Click to view similar products for [MOSFET](#) category:*

*Click to view products by [TECH PUBLIC](#) manufacturer:*

Other Similar products are found below :

[IRFD120](#) [IRFY240C](#) [JANTX2N5237](#) [2SK2267\(Q\)](#) [BUK455-60A/B](#) [MIC4420CM-TR](#) [VN1206L](#) [NDP4060](#) [SI4482DY](#)  
[IPS70R2K0CEAKMA1](#) [SQD23N06-31L-GE3](#) [TK16J60W,S1VQ\(O](#) [2SK2614\(TE16L1,Q\)](#) [DMN1017UCP3-7](#) [EFC2J004NUZTDG](#)  
[DMN1053UCP4-7](#) [SQJ469EP-T1-GE3](#) [NTE2384](#) [DMC2700UDMQ-7](#) [DMN2080UCB4-7](#) [DMN61D9UWQ-13](#) [US6M2GTR](#)  
[DMN31D5UDJ-7](#) [DMP22D4UFO-7B](#) [DMN1006UCA6-7](#) [DMN16M9UCA6-7](#) [STF5N65M6](#) [IRF40H233XTMA1](#) [STU5N65M6](#)  
[DMN6022SSD-13](#) [DMN13M9UCA6-7](#) [DMTH10H4M6SPS-13](#) [DMN2990UFB-7B](#) [IPB80P04P405ATMA2](#) [2N7002W-G](#) [MCAC30N06Y-](#)  
[TP](#) [MCQ7328-TP](#) [NTMC083NP10M5L](#) [NVMFS2D3P04M8LT1G](#) [BXP7N65D](#) [BXP4N65F](#) [AOL1454G](#) [WMJ80N60C4](#) [BXP2N20L](#)  
[BXP2N65D](#) [BXT1150N10J](#) [BXT1700P06M](#) [TSM60NB380CP](#) [ROG](#) [RQ7L055BGTCR](#) [DMNH15H110SK3-13](#)