

Features

- * 350W peak pulse power (8/20 μ s)
- * Low operating :3.3V
- * Ultra low capacitance: 1.0 pF typical
- * Ultra low leakage: nA level
- * Low clamping voltage
- * Protects one power line or data line
- * Complies with following standards:
 - IEC 61000-4-2 (ESD) immunity test
Air discharge: \pm 30kV
Contact discharge: \pm 30kV
 - IEC61000-4-4 (EFT) 40A (5/50ns)
- * RoHS Compliant

Mechanical Characteristics

- * Package: SOD.323
- * Lead Finish: Matte Tin
- * Case Material: “Green” Molding Compound.
- * UL Flammability Classification Rating 94V-0
- * Moisture Sensitivity: Level 3 per J-STD-020
- * Terminal Connections: See Diagram Below
- * Shipping Qty :3000pcs/7Inch Tape & Reel

Applications

- * USB Ports
- * Smart Phones
- * Wireless Systems
- * Ethernet 10/100/1000 Base T

Dimensions and Pin Configuration

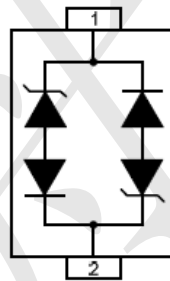

Marking: CC

Absolute Maximum Ratings (Tamb=25°C unless otherwise specified)

| Parameter | Symbol | Value | Unit |
|---------------------------------|--------|-------------|------|
| ESD per IEC 61000-4-2 (Air) | VESD | ±30 | kV |
| ESD per IEC 61000-4-2 (Contact) | | ±30 | |
| Operating Temperature Range | TJ | -55 to +125 | °C |
| Storage Temperature Range | Tstg | -55 to +150 | °C |

Electrical Characteristics (TA=25°C unless otherwise specified)

| Symbol | Parameter |
|-----------|-------------------------------------|
| V_{RWM} | Nominal Reverse Working Voltage |
| I_R | Reverse Leakage Current @ V_{RWM} |
| V_{BR} | Reverse Breakdown Voltage @ I_T |
| I_T | Test Current for Reverse Breakdown |
| V_C | Clamping Voltage @ I_{PP} |
| I_{PP} | Maximum Peak Pulse Current |
| C_{ESD} | Parasitic Capacitance |
| V_R | Reverse Voltage |
| f | Small Signal Frequency |

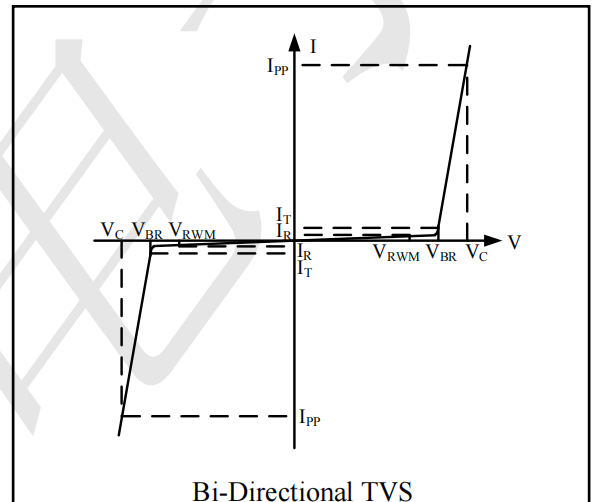

| Parameter | Symbol | Test Condition | Min | Typ | Max | Unit |
|-------------------------|-----------|---------------------------------|-----|-----|-----|------|
| Reverse Working Voltage | V_{RWM} | | | | 3.3 | V |
| Breakdown Voltage | V_{BR} | $I_T = 1mA$ | 4 | | 6 | V |
| Reverse Leakage Current | I_R | $V_{RWM} = 3.3V$ | | | 0.2 | μA |
| Clamping Voltage | V_C | $I_{PP} = 1A$ (8 x 20μs pulse) | | | 9 | V |
| Clamping Voltage | V_C | $I_{PP} = 20A$ (8 x 20us pulse) | | 16 | | V |
| Junction Capacitance | C_J | $V_R = 0V, f = 1MHz$ | | 1 | | pF |

Electrical Characteristics ($T_A=25^\circ\text{C}$ unless otherwise specified)

Fig1. 8/20 μs Pulse Waveform

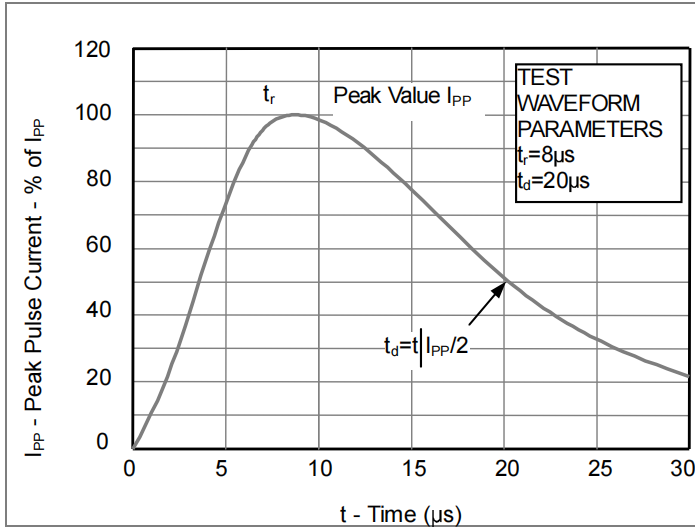

Fig2. ESD Pulse Waveform (according to IEC 61000-4-2)

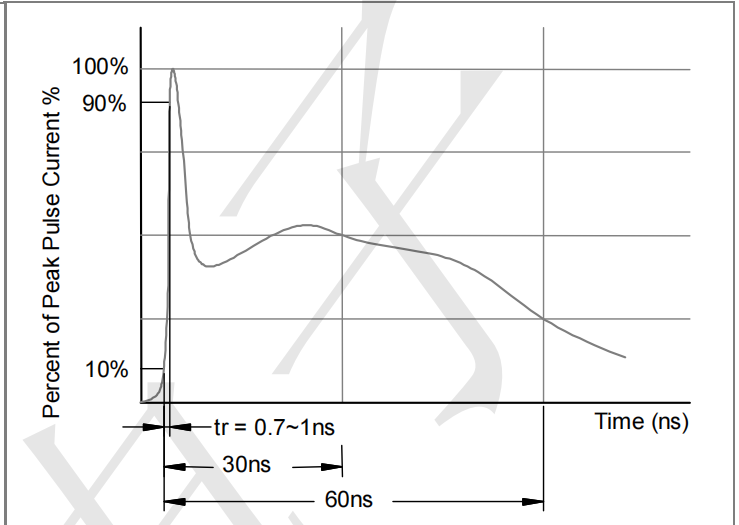
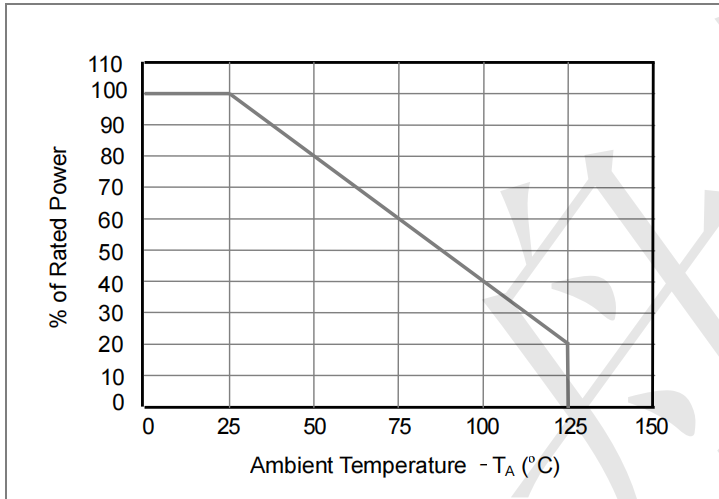
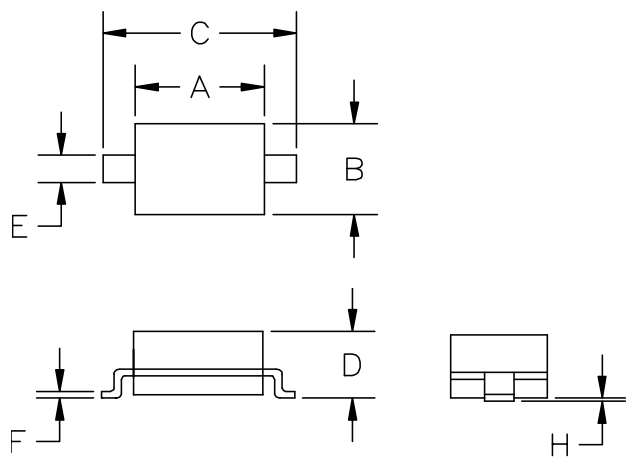

Fig3. Power Derating Curve



Outline Drawing - SOD-323



| SYM | DIMENSIONS | | | |
|-----|-------------|------|--------|-------|
| | MILLIMETERS | | INCHES | |
| | MIN | MAX | MIN | MAX |
| A | 1.50 | 1.80 | 0.060 | 0.071 |
| B | 1.20 | 1.40 | 0.045 | 0.054 |
| C | 2.30 | 2.70 | 0.090 | 0.107 |
| D | - | 1.10 | - | 0.043 |
| E | 0.30 | 0.40 | 0.012 | 0.016 |
| F | 0.10 | 0.25 | 0.004 | 0.010 |
| H | - | 0.10 | - | 0.004 |

Land Pattern - SOD-323

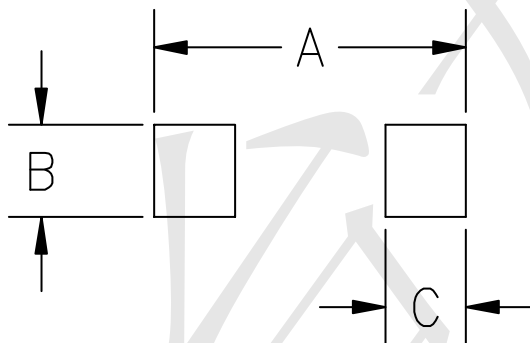

| SYM | DIMENSIONS | |
|-----|-------------|--------|
| | MILLIMETERS | INCHES |
| A | 3.15 | 0.120 |
| B | 0.80 | 0.031 |
| C | 0.80 | 0.031 |

X-ON Electronics

Largest Supplier of Electrical and Electronic Components

Click to view similar products for [ESD Suppressors / TVS Diodes](#) category:

Click to view products by [TECH PUBLIC](#) manufacturer:

Other Similar products are found below :

[60KS200C](#) [D18V0L1B2LP-7B](#) [D5V0F4U5P5-7](#) [NTE4902](#) [P4KE27CA](#) [P6KE11CA](#) [P6KE8.2A](#) [SA60CA](#) [SA64CA](#) [SMBJ12CATR](#)
[SMBJ33CATR](#) [SMBJ6.5A](#) [SMBJ8.0A](#) [ESD101-B1-02ELS E6327](#) [ESD112-B1-02EL E6327](#) [ESD7451N2T5G](#) [19180-510](#) [CPDT-5V0USP-](#)
[HF](#) [3.0SMCJ33CA-F](#) [3.0SMCJ36A-F](#) [HSPC16701B02TP](#) [JANTX1N6126A](#) [D3V3Q1B2DLP3-7](#) [D55V0M1B2WS-7](#) [SCM1293A-04SO](#)
[ESD200-B1-CSP0201 E6327](#) [SM12-7](#) [CEN955 W/DATA](#) [VESD12A1A-HD1-GS08](#) [CPDQC5V0-HF](#) [D1213A-01LP4-7B](#) [ESD101-B1-02EL](#)
[E6327](#) [AOZ8808DI-03](#) [5KP15A](#) [5KP48A](#) [5KP90A](#) [ESD3V3D7-TP](#) [15KPA36A-LF](#) [P4KE56CA](#) [P4KE68A](#) [P4KE91CATR](#) [P6KE120A](#)
[P6KE13CA](#) [P6KE43CA](#) [P6KE6.8CA](#) [P6KE8.2](#) [P6SMBJ20CA](#) [JANTX1N6072A](#) [SR2835ESKG](#) [SA90CA](#)