

## Features

- \* 350W peak pulse power (8/20 $\mu$ s)
- \* Low operating :3.3V
- \* Ultra low capacitance: 1.0 pF typical
- \* Ultra low leakage: nA level
- \* Low clamping voltage
- \* Protects one power line or data line
- \* Complies with following standards:
  - IEC 61000-4-2 (ESD) immunity test  
Air discharge:  $\pm$ 30kV  
Contact discharge:  $\pm$ 30kV
  - IEC61000-4-4 (EFT) 40A (5/50ns)
- \* RoHS Compliant

## Mechanical Characteristics

- \* Package: SOD.323
- \* Lead Finish: Matte Tin
- \* Case Material: “Green” Molding Compound.
- \* UL Flammability Classification Rating 94V-0
- \* Moisture Sensitivity: Level 3 per J-STD-020
- \* Terminal Connections: See Diagram Below
- \* Shipping Qty :3000pcs/7Inch Tape & Reel

## Applications

- \* USB Ports
- \* Smart Phones
- \* Wireless Systems
- \* Ethernet 10/100/1000 Base T

## Dimensions and Pin Configuration

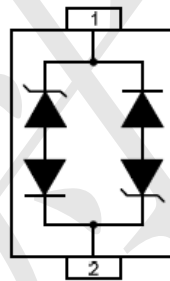

Marking:CC

**Absolute Maximum Ratings** (Tamb=25°C unless otherwise specified)

Parameter	Symbol	Value	Unit
ESD per IEC 61000-4-2 (Air)	VESD	±30	kV
ESD per IEC 61000-4-2 (Contact)		±30	
Operating Temperature Range	TJ	-55 to +125	°C
Storage Temperature Range	Tstg	-55 to +150	°C

**Electrical Characteristics** (TA=25°C unless otherwise specified)

Symbol	Parameter
$V_{RWM}$	Nominal Reverse Working Voltage
$I_R$	Reverse Leakage Current @ $V_{RWM}$
$V_{BR}$	Reverse Breakdown Voltage @ $I_T$
$I_T$	Test Current for Reverse Breakdown
$V_C$	Clamping Voltage @ $I_{PP}$
$I_{PP}$	Maximum Peak Pulse Current
$C_{ESD}$	Parasitic Capacitance
$V_R$	Reverse Voltage
f	Small Signal Frequency

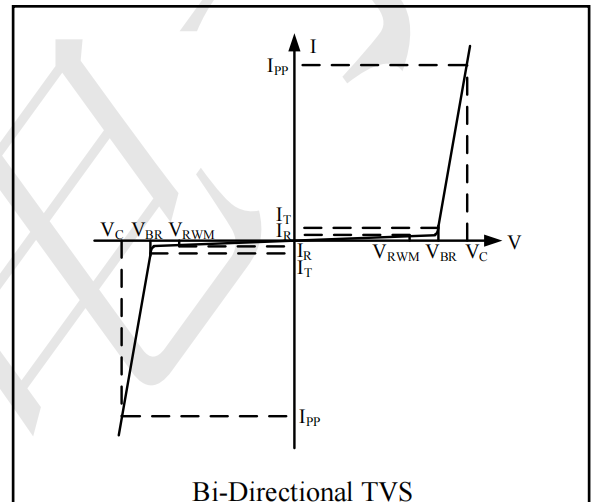

Parameter	Symbol	Test Condition	Min	Typ	Max	Unit
Reverse Working Voltage	$V_{RWM}$				3.3	V
Breakdown Voltage	$V_{BR}$	$I_T = 1\text{mA}$	4			V
Reverse Leakage Current	$I_R$	$V_{RWM} = 3.3\text{V}$			0.2	$\mu\text{A}$
Clamping Voltage	$V_C$	$I_{PP} = 1\text{A}$ (8 x 20 $\mu\text{s}$ pulse)			9	V
Clamping Voltage	$V_C$	$I_{PP} = 20\text{A}$ (8 x 20 $\mu\text{s}$ pulse)		16		V
Junction Capacitance	$C_J$	$V_R = 0\text{V}$ , $f = 1\text{MHz}$		1		pF

**Electrical Characteristics ( $T_A=25^\circ\text{C}$  unless otherwise specified)**

**Fig1. 8/20 $\mu\text{s}$  Pulse Waveform**

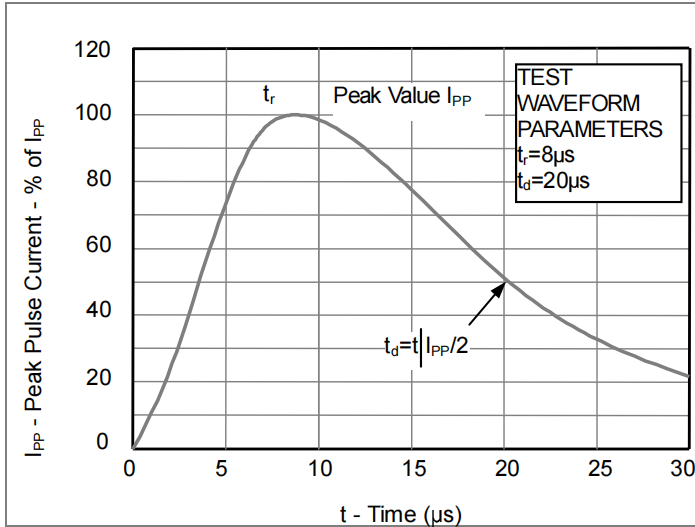

**Fig2. ESD Pulse Waveform (according to IEC 61000-4-2)**

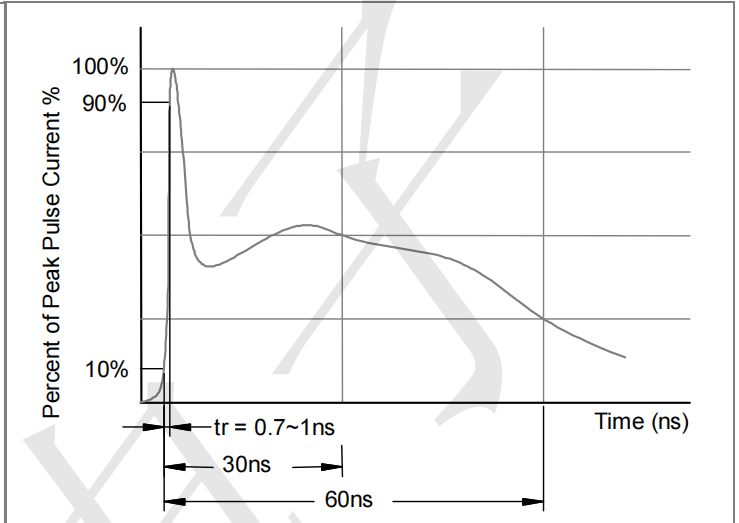

**Fig3. Power Derating Curve**

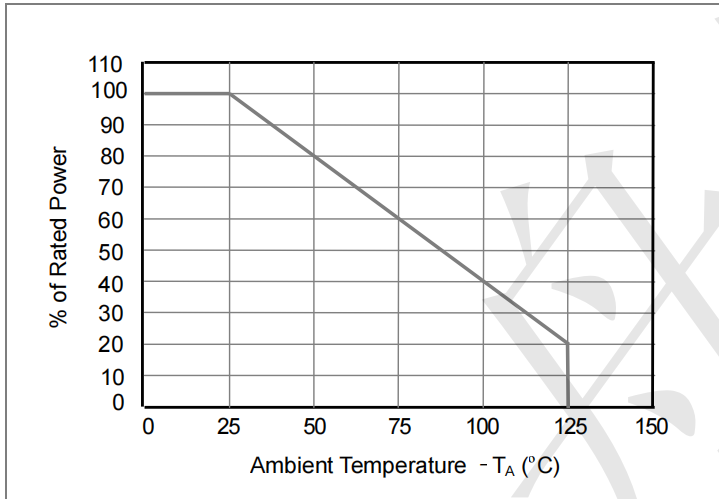

**Outline Drawing - SOD-323**

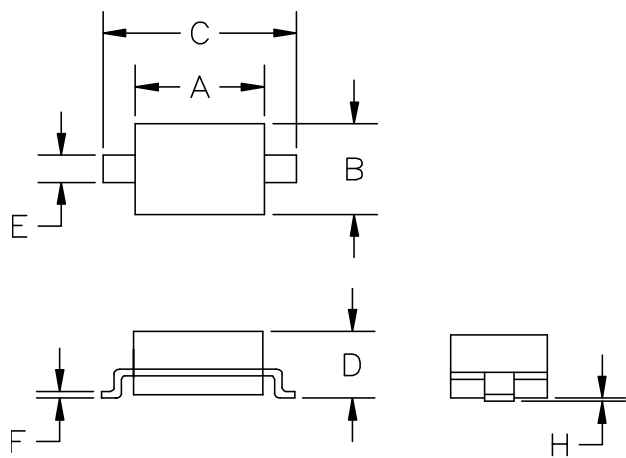

SYM	DIMENSIONS			
	MILLIMETERS		INCHES	
	MIN	MAX	MIN	MAX
A	1.50	1.80	0.060	0.071
B	1.20	1.40	0.045	0.054
C	2.30	2.70	0.090	0.107
D	-	1.10	-	0.043
E	0.30	0.40	0.012	0.016
F	0.10	0.25	0.004	0.010
H	-	0.10	-	0.004

**Land Pattern - SOD-323**

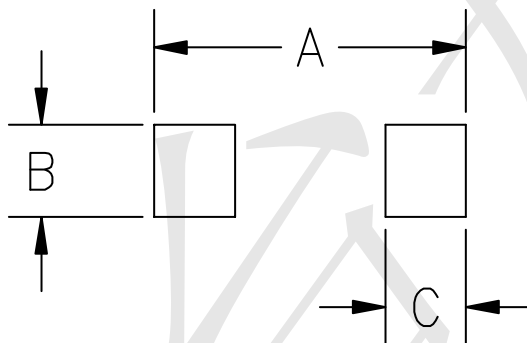

SYM	DIMENSIONS	
	MILLIMETERS	INCHES
A	3.15	0.120
B	0.80	0.031
C	0.80	0.031

## X-ON Electronics

Largest Supplier of Electrical and Electronic Components

*Click to view similar products for [ESD Suppressors / TVS Diodes](#) category:*

*Click to view products by [TECH PUBLIC](#) manufacturer:*

Other Similar products are found below :

[60KS200C](#) [D18V0L1B2LP-7B](#) [D5V0F4U5P5-7](#) [NTE4902](#) [P4KE27CA](#) [P6KE11CA](#) [P6KE8.2A](#) [SA60CA](#) [SA64CA](#) [SMBJ12CATR](#)  
[SMBJ33CATR](#) [SMBJ6.5A](#) [SMBJ8.0A](#) [ESD101-B1-02ELS E6327](#) [ESD112-B1-02EL E6327](#) [ESD7451N2T5G](#) [19180-510](#) [CPDT-5V0USP-](#)  
[HF](#) [3.0SMCJ33CA-F](#) [3.0SMCJ36A-F](#) [HSPC16701B02TP](#) [JANTX1N6126A](#) [D3V3Q1B2DLP3-7](#) [D55V0M1B2WS-7](#) [SCM1293A-04SO](#)  
[ESD200-B1-CSP0201 E6327](#) [SM12-7](#) [CEN955 W/DATA](#) [VESD12A1A-HD1-GS08](#) [CPDQC5V0-HF](#) [D1213A-01LP4-7B](#) [ESD101-B1-02EL](#)  
[E6327](#) [AOZ8808DI-03](#) [5KP15A](#) [5KP48A](#) [5KP90A](#) [ESD3V3D7-TP](#) [15KPA36A-LF](#) [P4KE56CA](#) [P4KE68A](#) [P4KE91CATR](#) [P6KE120A](#)  
[P6KE13CA](#) [P6KE43CA](#) [P6KE6.8CA](#) [P6KE8.2](#) [P6SMBJ20CA](#) [JANTX1N6072A](#) [SR2835ESKG](#) [SA90CA](#)