

Features

- 150 Watts peak pulse power ($t_p = 8/20\mu s$)
- Transient protection for high speed data lines
- IEC 61000-4-2 (ESD) $\pm 25kV$ (air), $\pm 20kV$ (contact)
- IEC 61000-4-4 (EFT) 40A(5/50ns)
- Protects One Power or I/O Port
- Low leakage current
- Low operating and clamping voltages
- Solid-state silicon avalanche technology

Mechanical Characteristics

- Package: SOD-523
- Lead Finish: Matte Tin
- Case Material: "Green" Molding Compound.
- UL Flammability Classification Rating 94V-0
- Moisture Sensitivity: Level 3 per J-STD-020
- Terminal Connections: See Diagram Below
- Shipping Qty :3000pcs/7Inch Tape & Reel

Applications

- Cellular Handsets and Accessories
- Personal Digital Assistants
- Notebooks and Handhelds
- Portable Instrumentation
- Digital Cameras
- Peripherals
- Audio Players
- Keypads, Side Keys, LCD Displays, USB2.0

Dimensions and Pin Configuration

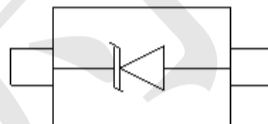

SOD-523 (Top View)

Marking:N5

Absolute Maximum Ratings ($T_A=25^\circ\text{C}$ unless otherwise specified)

Parameter	Symbol	Value	Unit
ESD per IEC 61000-4-2 (Air)	VESD	± 25	kV
ESD per IEC 61000-4-2 (Contact)		± 20	
Operating Temperature Range	TJ	-55 to +125	$^\circ\text{C}$
Storage Temperature Range	Tstg	-55 to +150	$^\circ\text{C}$

Electrical Characteristics ($T_A=25^\circ\text{C}$ unless otherwise specified)

Symbol	Parameter
I_{PP}	Maximum Reverse Peak Pulse Current
V_C	Clamping Voltage @ I_{PP}
V_{RWM}	Working Peak Reverse Voltage
I_R	Maximum Reverse Leakage Current @ V_{RWM}
V_{BR}	Breakdown Voltage @ I_T
I_T	Test Current
I_F	Forward Current
V_F	Forward Voltage @ I_F
P_{pk}	Peak Power Dissipation
C	Capacitance @ $V_R = 0$ and $f = 1.0$ MHz

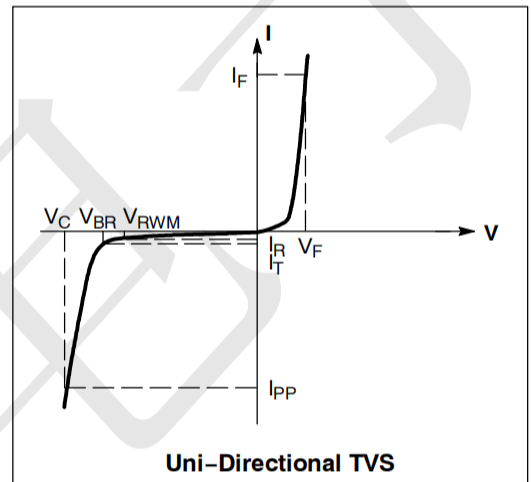

Parameter	Symbol	Min	Typ	Max	Unit	Test Condition
Reverse Working Voltage	V_{RWM}			24	V	
Breakdown Voltage	V_{BR}	26.5			V	$I_T = 1\text{mA}$
Reverse Leakage Current	I_R			0.2	μA	$V_{RWM} = 24\text{V}$
Clamping Voltage	V_C			42	V	$I_{PP} = 1\text{A}$ (8 x 20 μs pulse)
Clamping Voltage	V_C			55	V	$I_{PP} = 3\text{A}$ (8 x 20 μs pulse)
Junction Capacitance	CJ			25	pF	$V_R = 0\text{V}$, $f = 1\text{MHz}$

Characteristic Curves

Fig1. 8/20 μ s Pulse Waveform

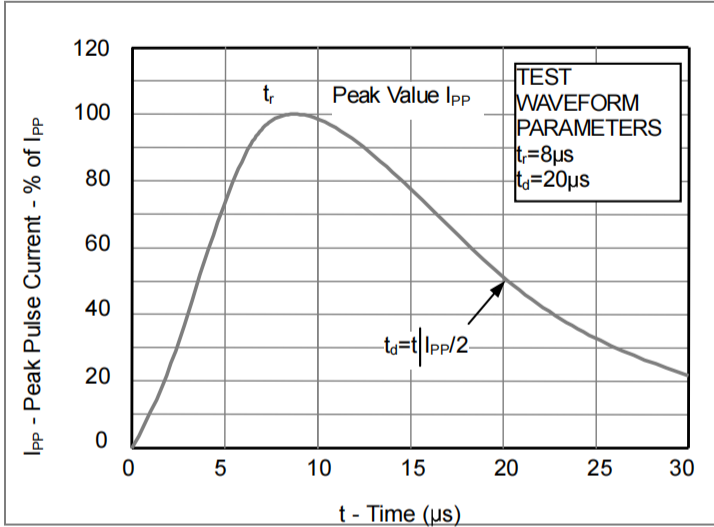

Fig2. ESD Pulse Waveform (according to IEC 61000-4-2)

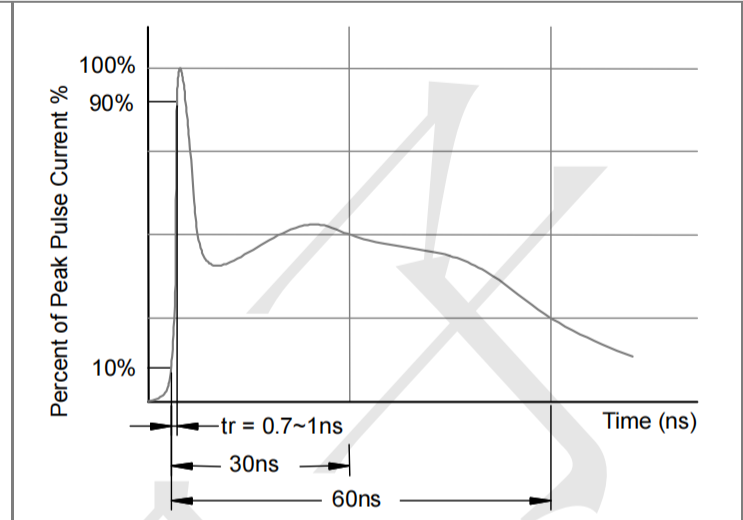
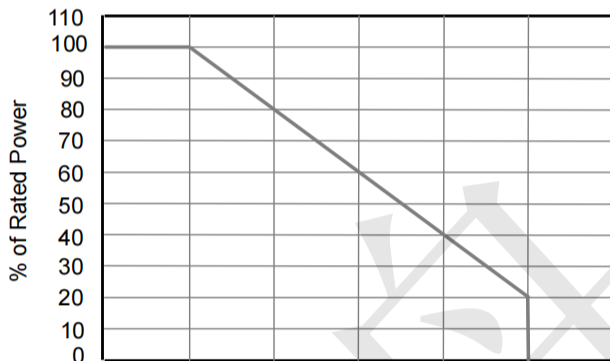
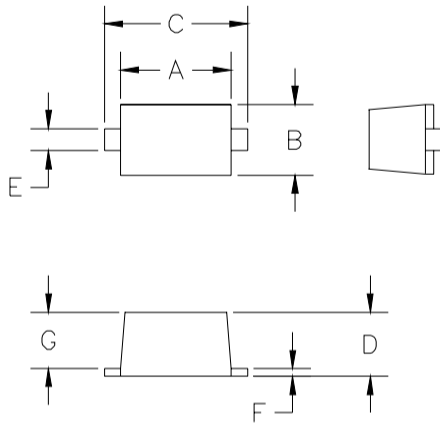

Fig3. Power Derating Curve



SOD-523 Package Outline Drawing



DIM ^N	INCHES		MM [1]		NOTE
	MIN	MAX	MIN	MAX	
A	.043	.051	1.10	1.30	—
B	.028	.035	0.70	0.90	—
C	.059	.067	1.50	1.70	—
D	.020	.028	0.50	0.70	—
E	.010	.014	0.25	0.35	—
F	.004	.008	0.10	0.20	—
G	.020	.028	0.50	0.70	—

[1] CONTROLLING DIMENSION: MILLIMETERS

Suggested Land Pattern

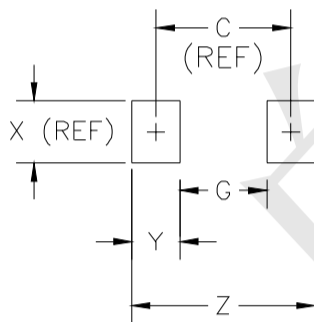

DIM ^N	INCHES		MM [1]		NOTE
	MIN	MAX	MIN	MAX	
C	—	.067	—	1.70	REF
G	—	.043	—	1.10	—
X	—	.031	—	0.80	REF
Y	—	.024	—	0.60	—
Z	—	.091	—	2.30	—

[1] CONTROLLING DIMENSION: MILLIMETERS

X-ON Electronics

Largest Supplier of Electrical and Electronic Components

Click to view similar products for [ESD Suppressors / TVS Diodes](#) category:

Click to view products by [TECH PUBLIC](#) manufacturer:

Other Similar products are found below :

[60KS200C](#) [D18V0L1B2LP-7B](#) [D5V0F4U5P5-7](#) [NTE4902](#) [P4KE27CA](#) [P6KE11CA](#) [P6KE8.2A](#) [SA60CA](#) [SA64CA](#) [SMBJ12CATR](#)
[SMBJ33CATR](#) [SMBJ6.5A](#) [SMBJ8.0A](#) [ESD101-B1-02ELS](#) [E6327](#) [ESD112-B1-02EL](#) [E6327](#) [ESD7451N2T5G](#) [19180-510](#) [CPDT-5V0USP-](#)
[HF](#) [3.0SMCJ33CA-F](#) [3.0SMCJ36A-F](#) [HSPC16701B02TP](#) [JANTX1N6126A](#) [D3V3Q1B2DLP3-7](#) [D55V0M1B2WS-7](#) [SCM1293A-04SO](#)
[ESD200-B1-CSP0201](#) [E6327](#) [SM12-7](#) [CEN955 W/DATA](#) [VESD12A1A-HD1-GS08](#) [CPDQC5V0-HF](#) [D1213A-01LP4-7B](#) [ESD101-B1-02EL](#)
[E6327](#) [AOZ8808DI-03](#) [5KP15A](#) [5KP48A](#) [5KP90A](#) [ESD3V3D7-TP](#) [15KPA36A-LF](#) [P4KE56CA](#) [P4KE68A](#) [P4KE91CATR](#) [P6KE120A](#)
[P6KE13CA](#) [P6KE43CA](#) [P6KE6.8CA](#) [P6KE8.2](#) [P6SMBJ20CA](#) [JANTX1N6072A](#) [SR2835ESKG](#) [SA90CA](#)