

Product Summary

- -2.3A,-8V
- RDS(ON)=55mΩ @ VGS=4.5V(Typ)
- RDS(ON)=65mΩ @ VGS=2.5V(Typ)
- FDC6331L Pin to Pin fully compatible

Application

- Battery Packs
- Battery-Powered Portable Equipment
- Cellular and Cordless Telephones

Package and Pin Configuration

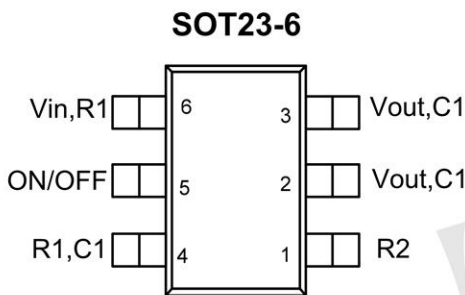

Marking: 323K

Circuit diagram

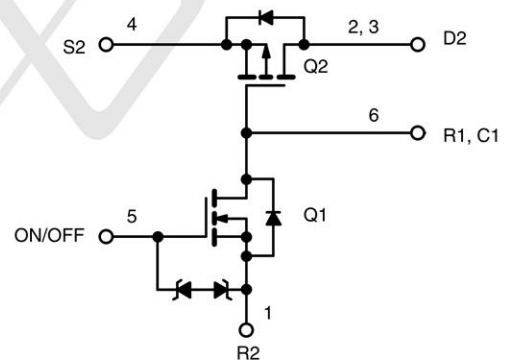

Absolute Maximum Ratings (T_A=25°C unless otherwise noted)

Symbol	Parameter	Limit	Unit
V _{IN}	Input Voltage	3-8	V
V _{ON/OFF}	ON/OFF Voltage	-1.5 to 8	
I _L	Continuous Load Current	-2.3	A
	Pulse Load Current	-5	
I _S	Continuous Source Current (Source-Drain Diode)	-1.0	
P _D	Maximum Power Dissipation	0.7	W
T _J , T _{STG}	Junction and Storage Temperature Range	-50 to +150	°C
ESD	ESD Rating, MIL-STD-883D HBM	2000	V
R _{0JA}	Thermal Resistance, Junction-to-Ambient	250	°C/W

Typical Application Circuit

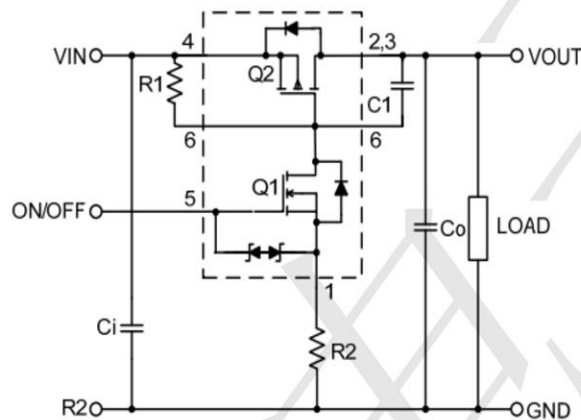

COMPONENTS		
R1	Pull-Up Resistor	Typical 20kΩ to 1MΩ*
R2	Optional Slew-Rate Control	Typical 0 to 50kΩ
C1	Optional Slew-Rate Control	Typical 1000pF

*Minimum R1 value should be at least $10 \times R2$ to ensure Q1 turn-on.

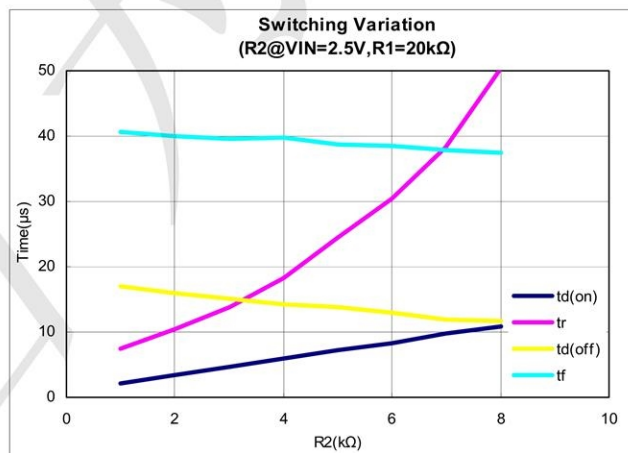

Note 1: For R2 switching variations with other VIN/R1 combinations, see Typical Characteristics.



Electrical Characteristics ($T_A = 25^\circ\text{C}$ unless otherwise noted)

Symbol	Parameter	Test Condition	Min	Typ	Max	Unit
OFF Characteristics						
I_{FL}	Reverse Leakage Current	$V_{IN}=8.0\text{V}, V_{ON/OFF}=0\text{V}$			1	μA
V_{SD}	Diode Forward Voltage	$I_S = -1\text{A}$	-0.4		-1.5	V
ON Characteristics						
V_{IN}	Input Voltage Range		3.0		8.0	V
Von/Off	On/Off Voltage		1.5		8.0	V
$R_{DS(ON)}$	Static Drain-to-Source On-Resistance	$V_{ON/OFF}=1.8\text{V}, V_{IN}=4.5\text{V}, I_D=1.0\text{A}$		0.055	0.070	Ω
		$V_{ON/OFF}=1.8\text{V}, V_{IN}=2.5\text{V}, I = 1.0\text{A}$		0.065	0.090	
$I_{D(on)}$	On-State (P-Channel) Drain Current	$V_{IN-OUT}\leq 0.2\text{V}, V_{IN}=5\text{V}, V_{ON/OFF}=1.5\text{V}$	1			A
		$V_{IN-OUT}\leq 0.3\text{V}, V_{IN}=3\text{V}, V_{ON/OFF}=1.8\text{V}$	1			

Typical Operating Characteristics

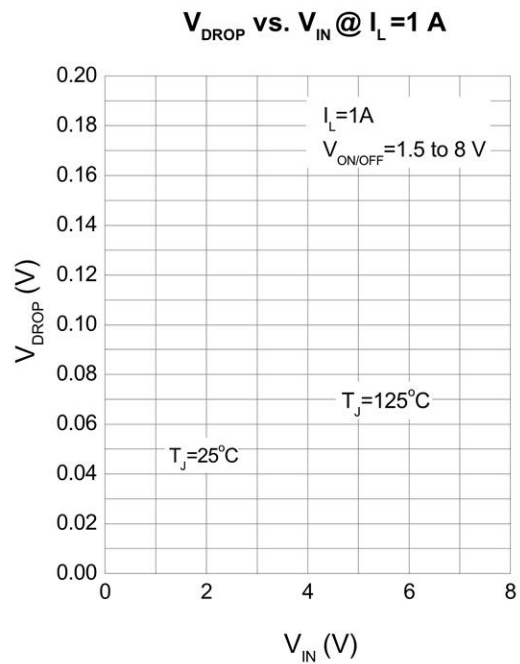
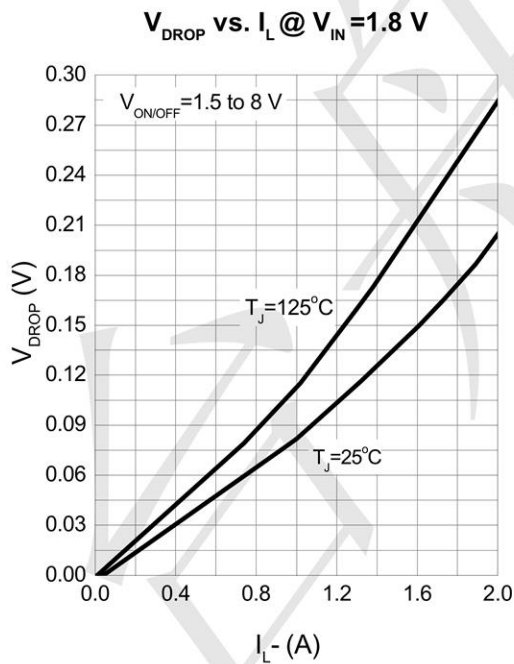
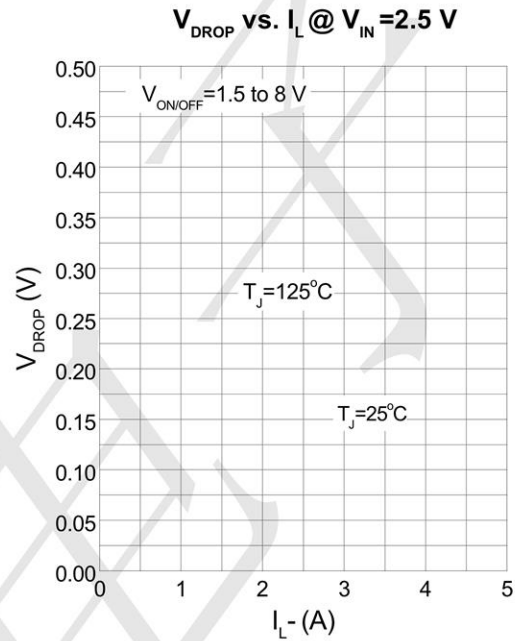
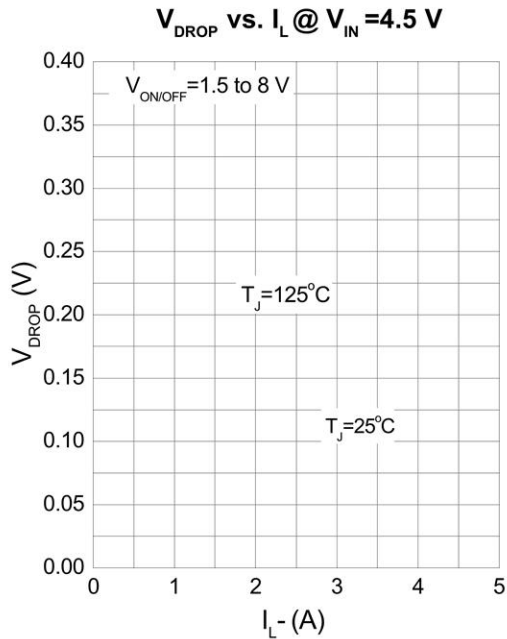

On-Resistance vs. Input Voltage

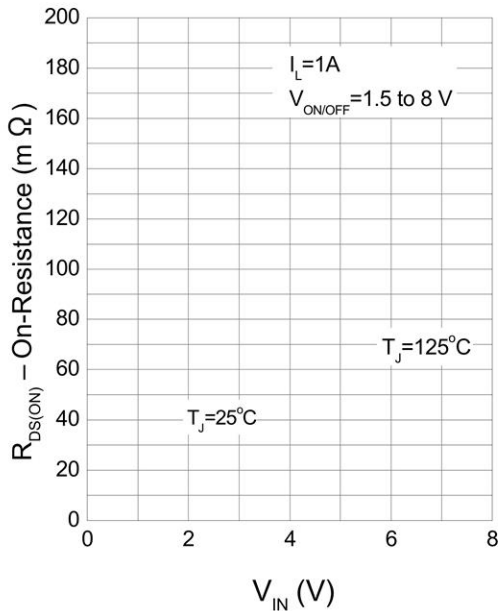

Thermal Transient Impedance

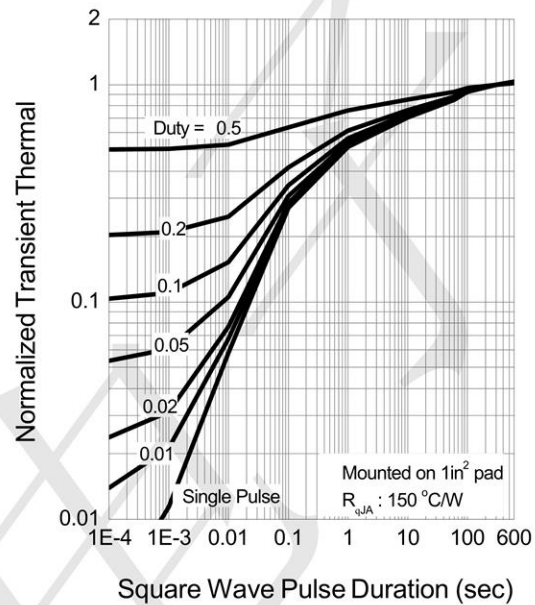

Switching Variation

R2 @ $V_{IN} = 4.5 \text{ V}$, R1 = 20 kΩ

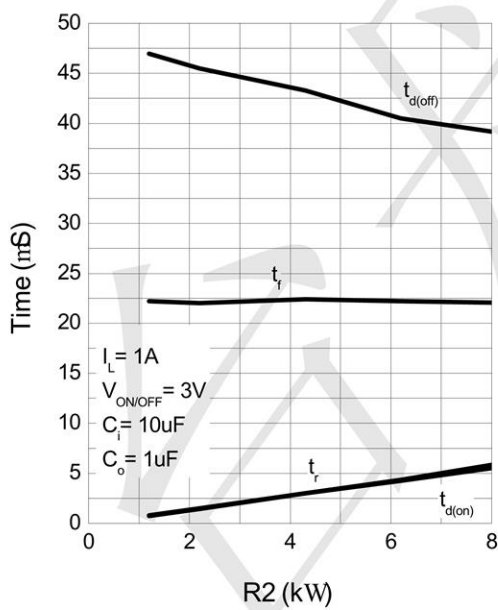

Switching Variation

R2 @ $V_{IN} = 2.5 \text{ V}$, R1 = 20 kΩ

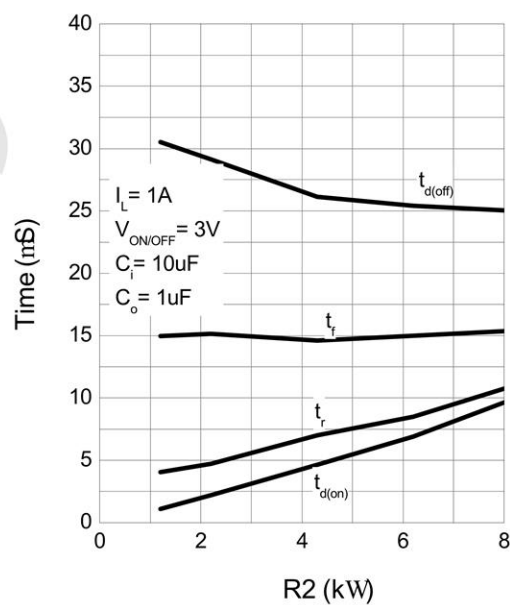

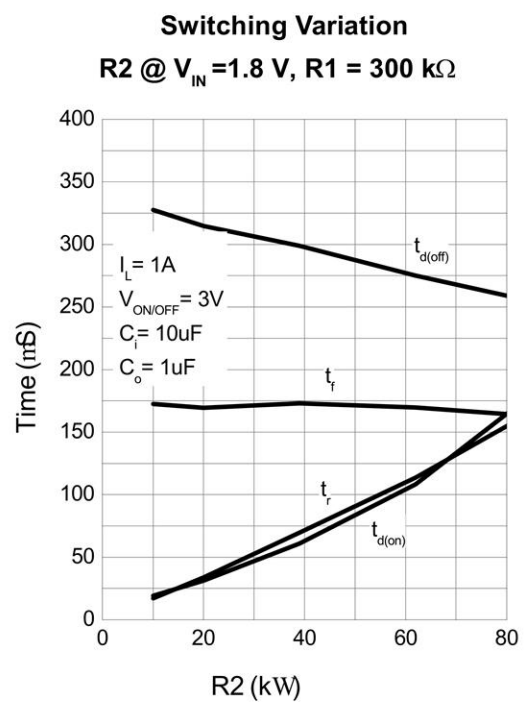
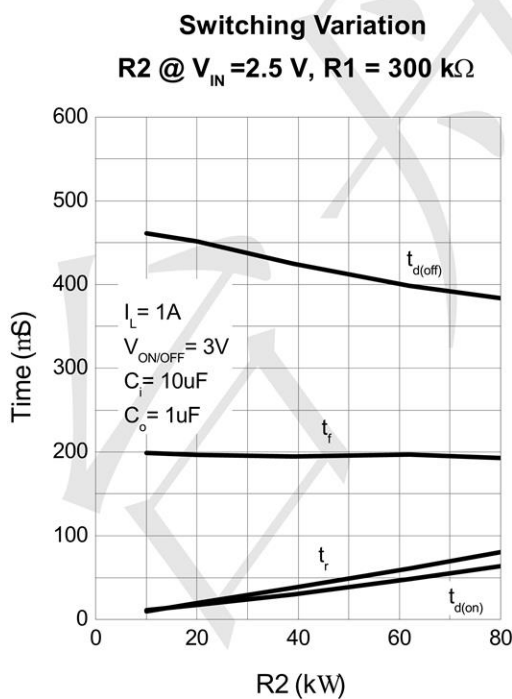
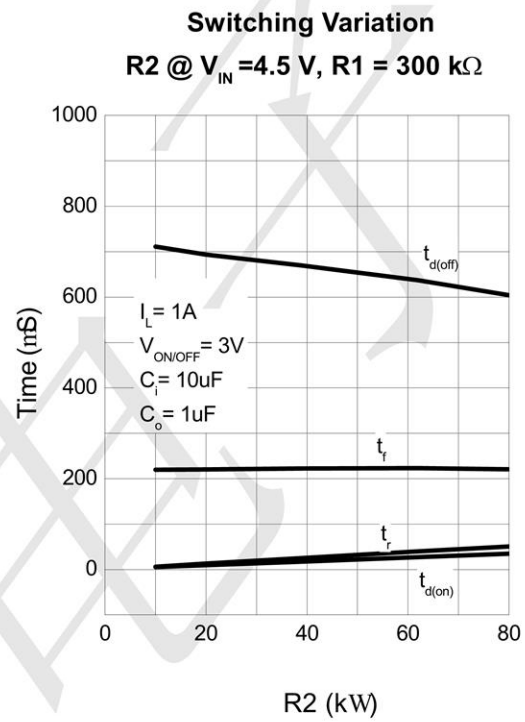
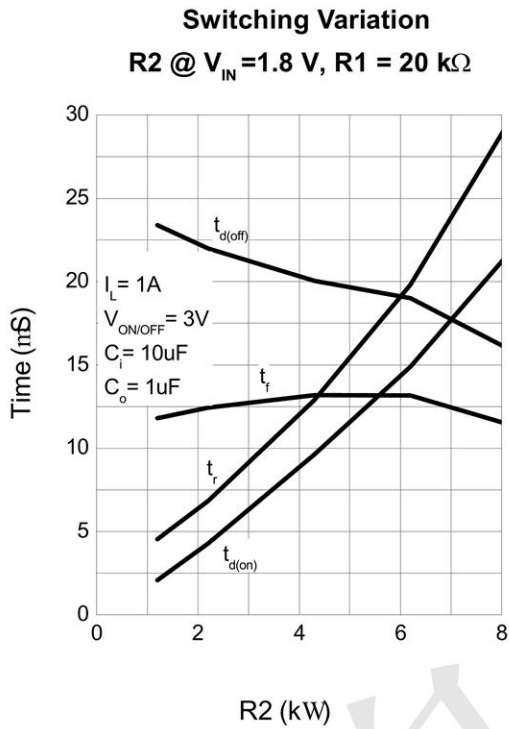



SOT23-6 Package Information

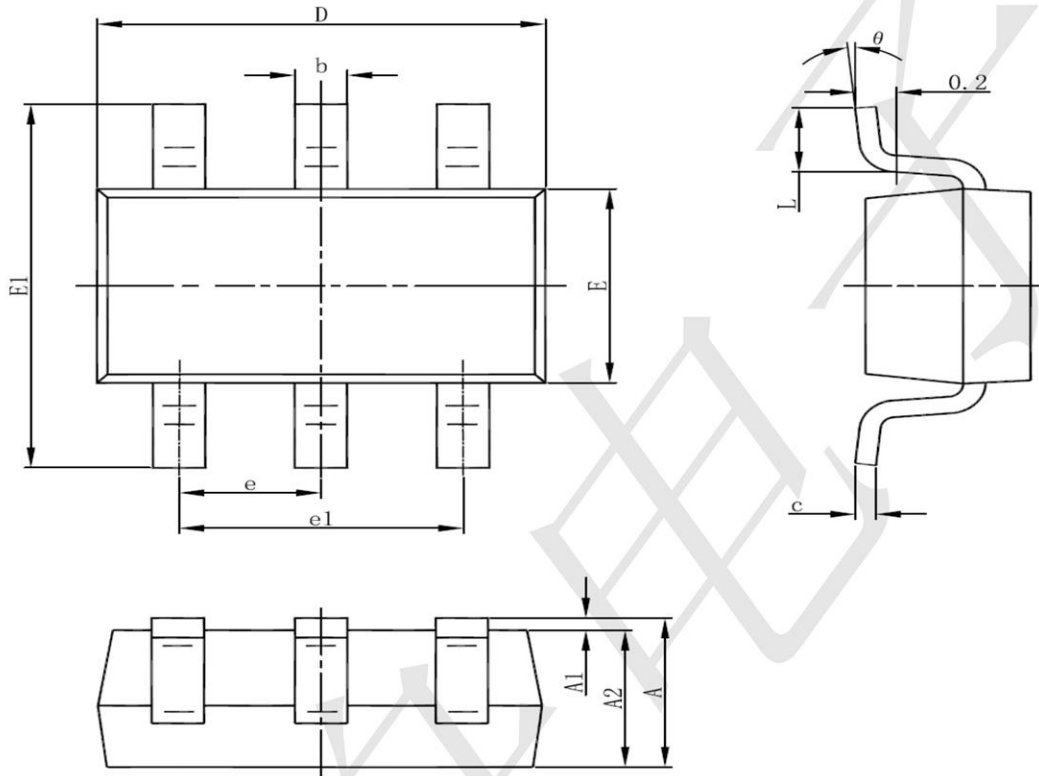

Symbol	Dimensions In Millimeters		Dimensions In Inches	
	Min	Max	Min	Max
A	1.050	1.250	0.041	0.049
A1	0.000	0.100	0.000	0.004
A2	1.050	1.150	0.041	0.045
b	0.300	0.500	0.012	0.020
c	0.100	0.200	0.004	0.008
D	2.820	3.020	0.111	0.119
E	1.500	1.700	0.059	0.067
E1	2.650	2.950	0.104	0.116
e	0.950(BSC)		0.037(BSC)	
e1	1.800	2.000	0.071	0.079
L	0.300	0.600	0.012	0.024
θ	0°	8°	0°	8°

X-ON Electronics

Largest Supplier of Electrical and Electronic Components

Click to view similar products for [Power Switch ICs - Power Distribution](#) category:

Click to view products by [TECH PUBLIC](#) manufacturer:

Other Similar products are found below :

[TLE6232GP](#) [NCP45520IMNTWG-L](#) [FPF1018](#) [DS1222](#) [NCV380HMUAJAATBG](#) [TCK2065G,LF](#) [SZNCP3712ASNT3G](#)
[NCP45520IMNTWG-H](#) [VND5004ATR-E](#) [ITS5215LXT](#) [AP22811BW5-7](#) [SLG5NT1437VTR](#) [SZNCP3712ASNT1G](#) [DML1008LDS-7](#)
[KTS1640QGDV-TR](#) [KTS1641QGDV-TR](#) [NCV459MNWTBG](#) [NCP4545IMNTWG-L](#) [FPF2260ATMX](#) [SLG5NT1765V](#) [SLG5NT1757V](#)
[NCP45780IMN24RTWG](#) [AP2151AMP-13](#) [NCP45540IMNTWG-L](#) [TPS2022P](#) [FPF2495BUCX](#) [NCP45650IMNTWG](#) [NCV8412ADDR2G](#)
[DK5V100R20S](#) [JW7111SSOTB#TRPBF](#) [RY2121](#) [TPNTGD1100LT1G](#) [TPS27081ADDCR-TP](#) [FDC6331L-TP](#) [FDC6329L-TP](#) [FDC6323L-](#)
[TP](#) [SI3865DDV](#) [TPS2116DRLR](#) [U3213](#) [BTS7020-2EPA](#) [BTT6100-2ERA](#) [BTS71220-4ESA](#) [RS2588CYF5](#) [RS2580XTDE8](#) [LP5308B6F](#)
[ME1502AM5G](#) [SGM2576YN5G/TR](#) [DK5V100R15M](#) [SY6287CDEC](#) [BSP75N](#)