

Product Summary

- $V_{drop} = 0.2V @ V_{in}=12V, I_L=2.0A, R_{DS(ON)}= 100m\Omega$
- $V_{drop} = 0.2V @ V_{in}=5.0V, I_L=1.8A, R_{DS(ON)}= 110m\Omega$
- $V_{drop} = 0.2V @ V_{in}=2.5V, I_L=1.4A, R_{DS(ON)}= 140m\Omega$

Application

- Battery Packs
- Battery-Powered Portable Equipment
- Cellular and Cordless Telephones

Package and Pin Configuration

SOT23-6

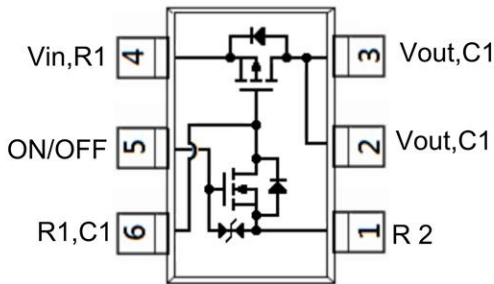

EQUIVALENT CIRCUIT

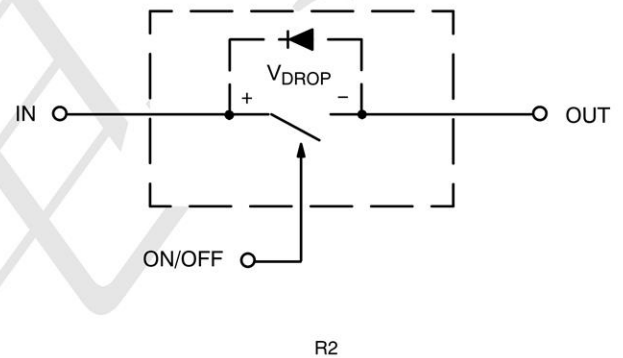

Marking: 324P

324P= is Part Number ,Fixed

Absolute Maximum Ratings ($T_A=25^\circ C$ unless otherwise noted)

PARAMETER	SYMBOL	Ratings	UNITS
Input Voltage Range ^(Note 1)	V_{IN}	20	V
On/Off Voltage Range	V_{ON}/V_{OFF}	12	V
Continuous Load Current ^{t(} Note 2,3)	I_D	2	A
Pulsed Load Current ⁽ Note 4)	I_D	8	A
Power Dissipation ⁽ Note 2)	P_D	0.83	W
Operating Junction and Storage Temperature Range	T_J, T_{STG}	-55~150	$^\circ C$
ESD, MIL-STD-883D HBM (100pF/1.5kohm) ($V_{on/off}$ pin)	V_{ESD}	2	kV
Typical Junction to Ambient ⁽ Note 2)	$R_{\theta JA}$	150	$^\circ C/W$

Electrical Characteristics ($T_A = 25^\circ\text{C}$ unless otherwise noted)

PARAMETER	SYMBOL	TEST CONDITION	MIN.	TYP.	MAX.	UNITS
Off Characteristics						
Leakage Current	I_{FL}	$V_{IN}=20\text{V}, V_{ON}/V_{OFF}=0\text{V}$	-	-	1	μA
Diode Forward Voltage	V_{SD}	$I_S=-1.0\text{A}$	-	-0.76	-1.2	V
On Characteristics						
Input Voltage Range	V_{IN}		2.5	-	20	V
On/Off Voltage Range	V_{ON}/V_{OFF}		2.5	-	12	V
Drain-Source On-State Resistance (Q2)	$R_{DS(on)}$	$V_{GS}=-12\text{V}, I_D=-2.0\text{A}$	-	84	100	m Ω
		$V_{GS}=-5.0\text{V}, I_D=-1.8\text{A}$	-	90	110	
		$V_{GS}=-2.5\text{V}, I_D=-1.4\text{A}$	-	110	140	

NOTES :

- V_{IN} Range can be up to 20V, but R1 and R2 must be scaled such that V_{GS} do not exceed 12V.
- $R_{\theta JA}$ is the sum of the junction-to-case and case-to-ambient thermal resistance where the case thermal reference is defined as the solder mounting surface of the drain pins mounted on a 1 inch FR-4 with 2oz. square pad of copper
- The maximum current rating is package limited
- Pulse test: pulse width $\leq 300\mu\text{s}$, duty cycle $\leq 2\%$

Typical Application Circuit

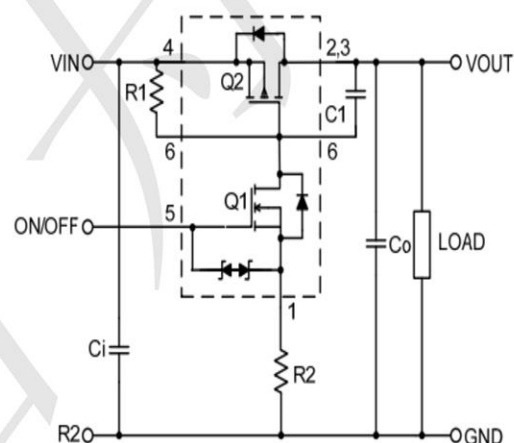

COMPONENTS		
R1	Pull-Up Resistor	Typical 10k Ω to 1M Ω *
R2	Optional Slew-Rate Control	Typical 0 to 100k Ω
C1	Optional Slew-Rate Control	Typical 1000pF

Typical Operating Characteristics

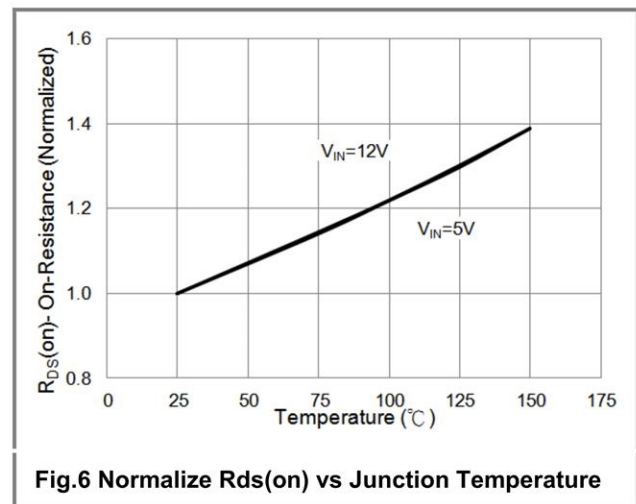
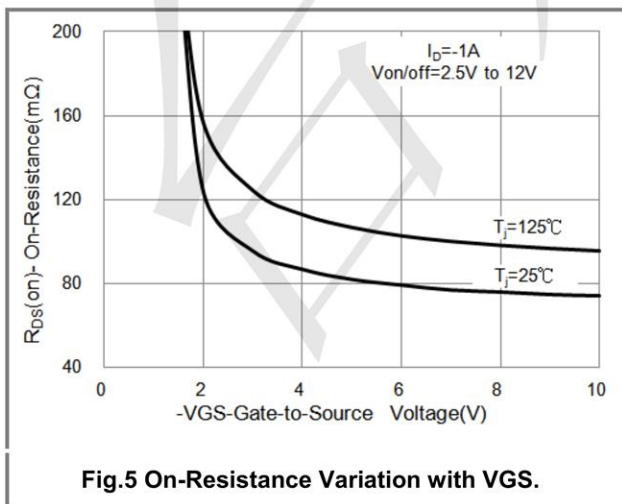
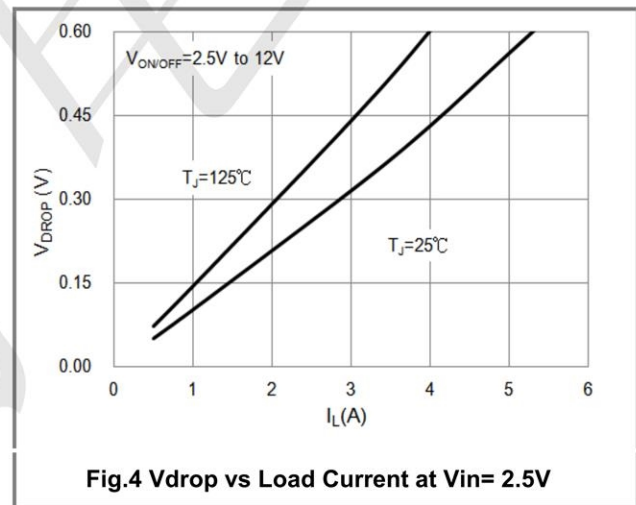
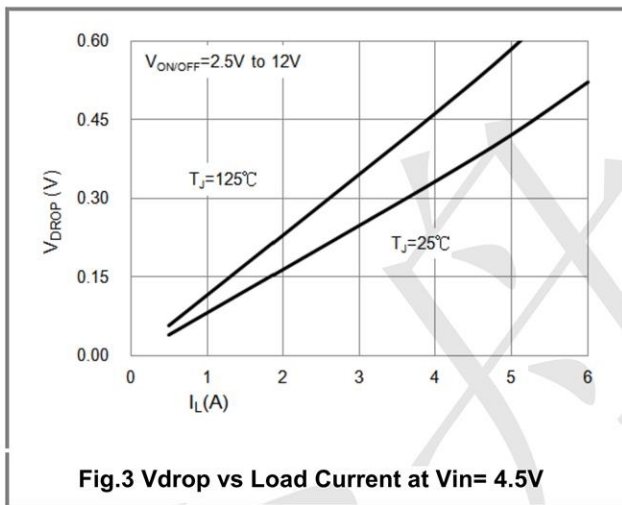
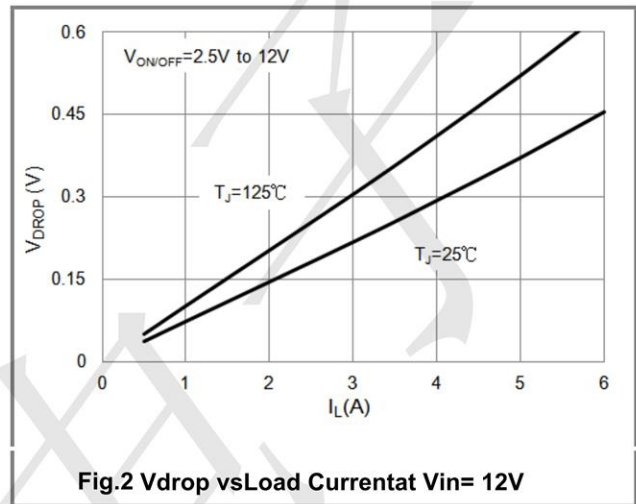
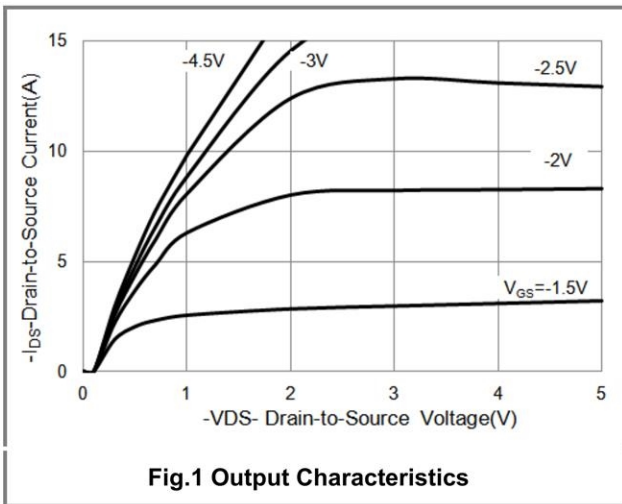

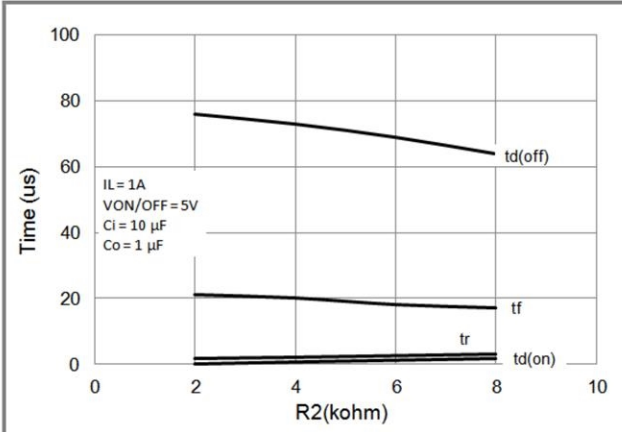

Fig.7 Switching Variation R2 at Vin=12V, R1=20k Ω

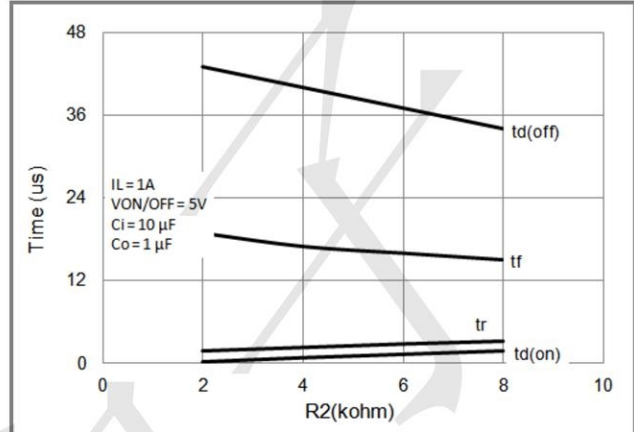

Fig.8 Switching Variation R2 at Vin= 5V, R1= 20k Ω

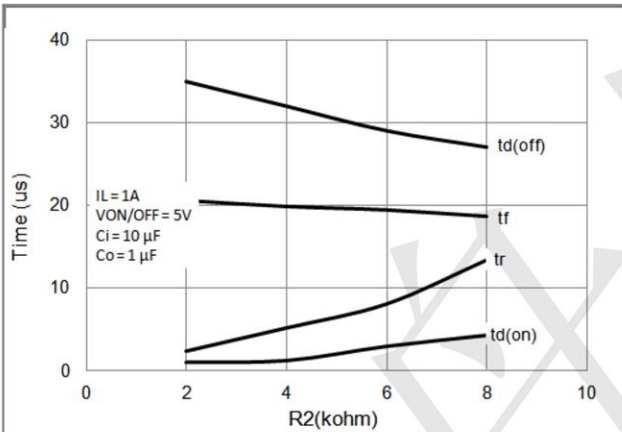

Fig.9 Switching Variation R2 at Vin=3.3V, R1=20k Ω

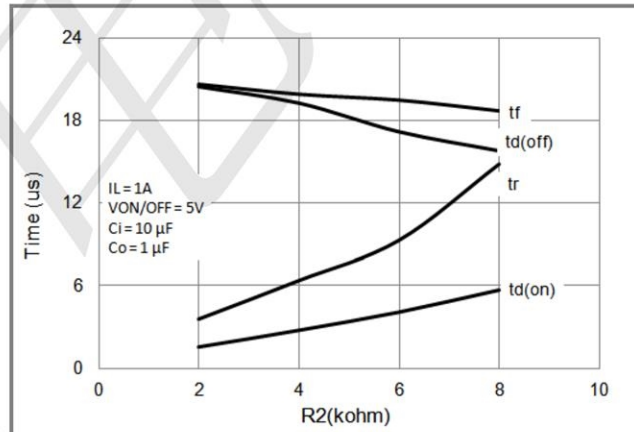

Fig.10 Switching Variation R2 at Vin=2.5V, R1=20k Ω

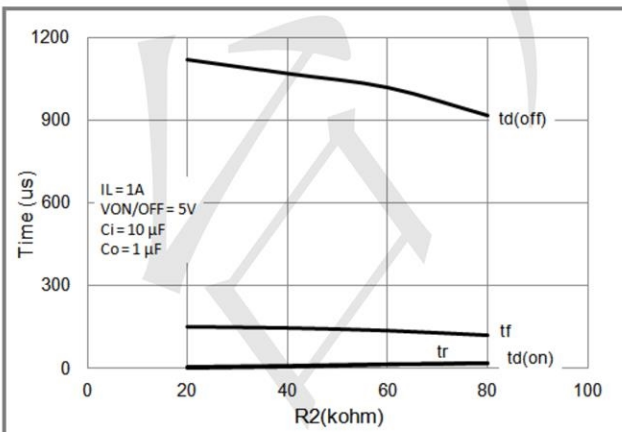

Fig.11 Switching Variation R2 at Vin=12V, R1=300k

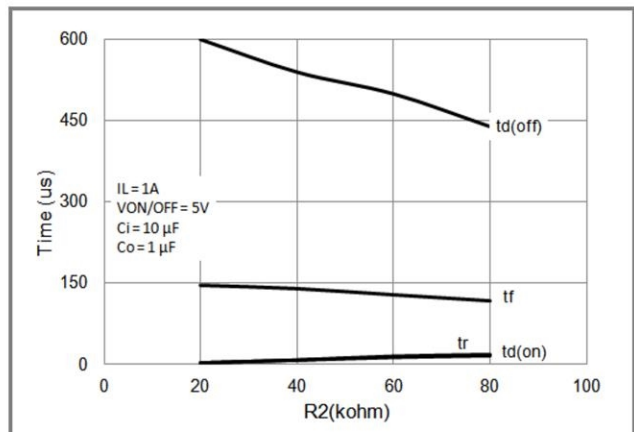
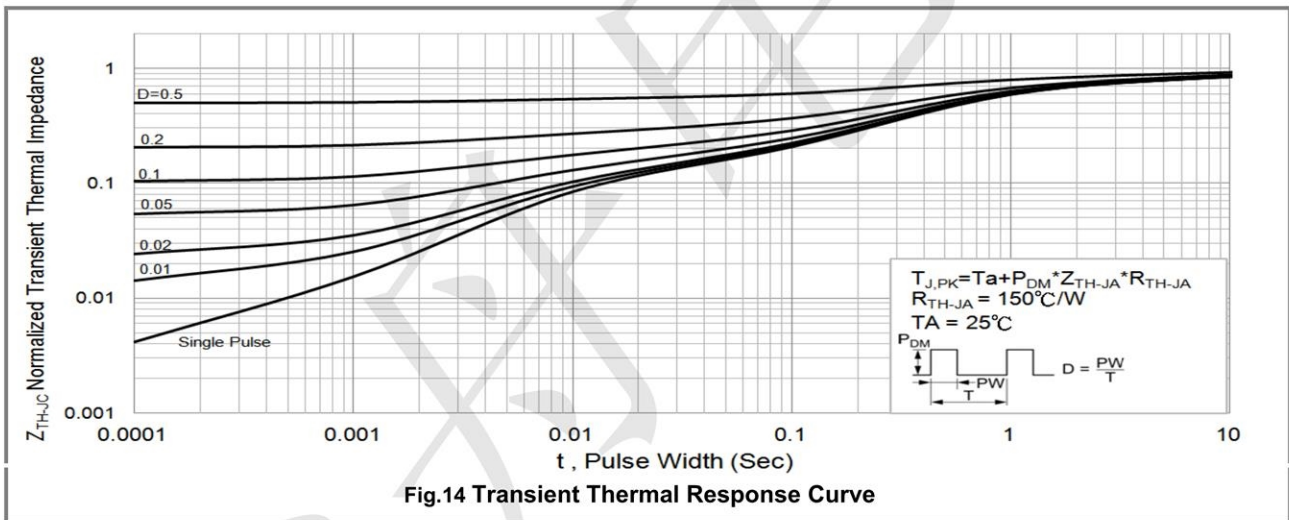
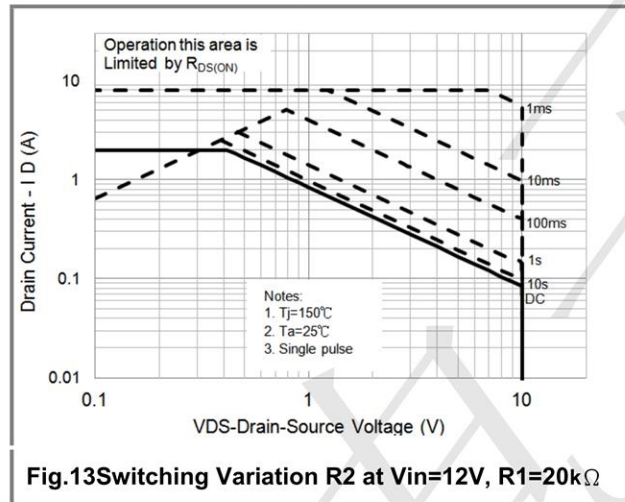
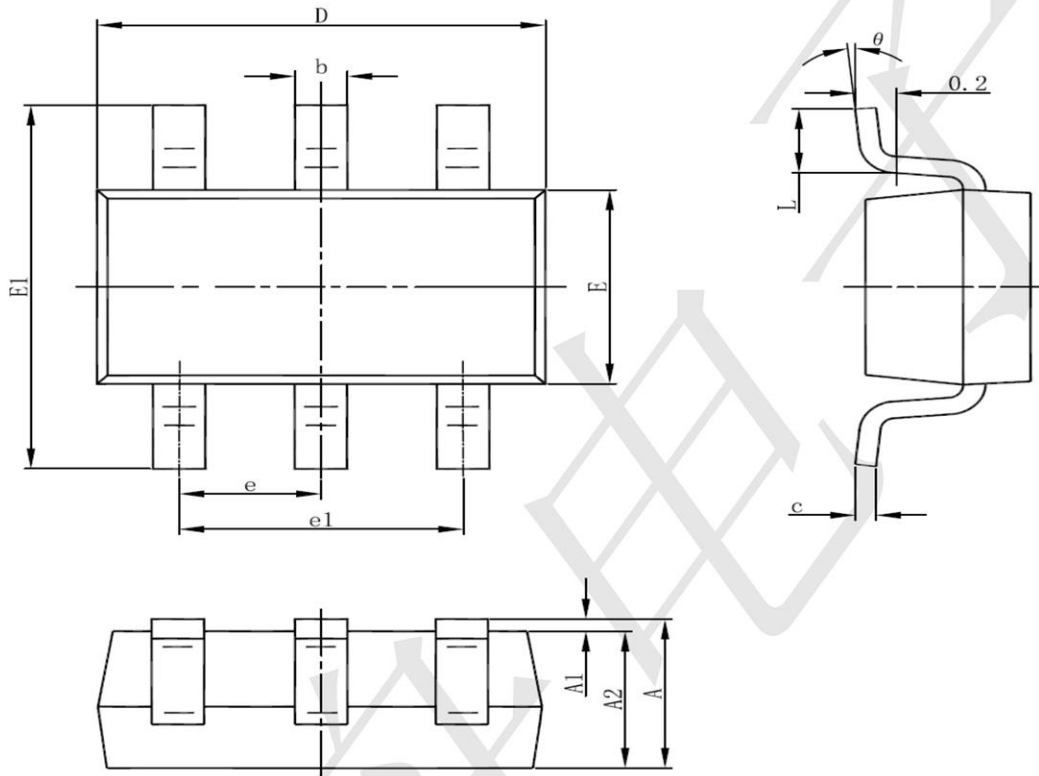

Fig.12 Switching Variation R2 at Vin=5V, R1=300k





SOT23-6 Package Information



Symbol	Dimensions In Millimeters		Dimensions In Inches	
	Min	Max	Min	Max
A	1.050	1.250	0.041	0.049
A1	0.000	0.100	0.000	0.004
A2	1.050	1.150	0.041	0.045
b	0.300	0.500	0.012	0.020
c	0.100	0.200	0.004	0.008
D	2.820	3.020	0.111	0.119
E	1.500	1.700	0.059	0.067
E1	2.650	2.950	0.104	0.116
e	0.950(BSC)		0.037(BSC)	
e1	1.800	2.000	0.071	0.079
L	0.300	0.600	0.012	0.024
θ	0°	8°	0°	8°

X-ON Electronics

Largest Supplier of Electrical and Electronic Components

Click to view similar products for [Power Switch ICs - Power Distribution](#) category:

Click to view products by [TECH PUBLIC](#) manufacturer:

Other Similar products are found below :

[NCP45520IMNTWG-L](#) [TCK111G,LF\(S](#) [FPF1018](#) [DS1222](#) [TCK2065G,LF](#) [SZNCP3712ASNT3G](#) [TLE7244SL](#) [MIC2033-05BYMT-T5](#)
[MIC2033-12AYMT-T5](#) [MIC2033-05BYM6-T5](#) [AP22811BW5-7](#) [SLG5NT1437VTR](#) [SZNCP3712ASNT1G](#) [DML1008LDS-7](#)
[KTS1640QGDV-TR](#) [KTS1641QGDV-TR](#) [BTS500101TADATMA2](#) [NCV459MNWTBG](#) [NCP4545IMNTWG-L](#) [NCV8412ASTT1G](#)
[NCV8412ASTT3G](#) [FPF2260ATMX](#) [SLG5NT1765V](#) [SLG5NT1757V](#) [SLG59M1557VTR](#) [BD2222G-GTR](#) [NCP45780IMN24RTWG](#)
[NCP45540IMNTWG-L](#) [TPNTJD1155LT1G](#) [FDC6324L-TP](#) [FDC6326L-TP](#) [TPSI1869DH-T1-E3](#) [SI1865DDL](#) [FDC6330L-TP](#) [U6210](#)
[U25135](#) [U62153](#) [U6513BS](#) [U62133](#) [U6773H](#) [U62143S](#) [U6315BS](#) [U6513B](#) [U6110](#) [SL3405S](#) [BTS7040-2EPA](#) [SY6282ACC](#) [WS3222D-](#)
[8/TR](#) [DP25136C](#) [DK5V100R20C](#)