

Product Summary

- 20V, 3.5A, $R_{DS(ON)} = 40m\Omega$ @ $V_{GS} = 4.5V$.
 $R_{DS(ON)} = 50m\Omega$ @ $V_{GS} = 2.5V$.
- -20V, -2.8A, $R_{DS(ON)} = 85m\Omega$ @ $V_{GS} = -4.5V$.
 $R_{DS(ON)} = 100m\Omega$ @ $V_{GS} = -2.5V$.

Application

- DC-DC Converters.
- Load Switch.
- Power Management.

Package and Pin Configuration

SOT23-6 Or TSOP-6

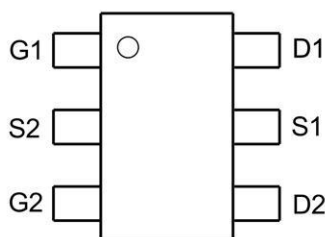

Circuit diagram

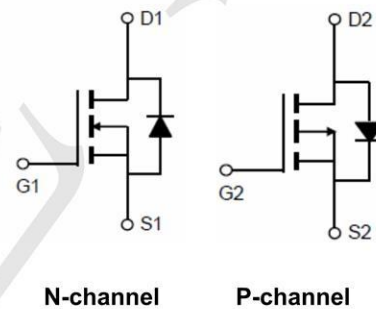

N-channel

P-channel

Marking:

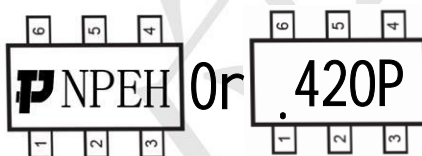

Absolute Maximum Ratings ($T_A=25^\circ C$ unless otherwise noted)

Parameter	Symbol	N-Channel	P-Channel	Units
Drain-Source Voltage	V_{DS}	20	-20	V
Gate-Source Voltage	V_{GS}	± 12	± 12	V
Drain Current-Continuous	I_D	3.5	-2.8	A
Drain Current-Pulsed ^a	I_{DM}	14	10	A
Maximum Power Dissipation	P_D	1.14		W
Operating and Store Temperature Range	T_J, T_{stg}	-55 to 150		$^\circ C$

Thermal Characteristic

Parameter	Symbol	Limit	Units
Thermal Resistance, Junction-to-Ambient ^b	$R_{\theta JA}$	110	$^\circ C/W$

N-CH Electrical Characteristics (T_A=25°C unless otherwise noted)

Parameter	Symbol	Test Condition	Min	Typ	Max	Units
Off Characteristics						
Drain-Source Breakdown Voltage	BV _{DSS}	V _{GS} = 0V, I _D = 250μA	20			V
Zero Gate Voltage Drain Current	I _{DSS}	V _{DS} = 20V, V _{GS} = 0V			1	μA
Gate Body Leakage Current, Forward	I _{GSSF}	V _{GS} = 12V, V _{DS} = 0V			100	nA
Gate Body Leakage Current, Reverse	I _{GSSR}	V _{GS} = -12V, V _{DS} = 0V			-100	nA
On Characteristics^c						
Gate Threshold Voltage	V _{GS(th)}	V _{GS} = V _{DS} , I _D = 250μA	0.4		1.2	V
Static Drain-Source On-Resistance	R _{DS(on)}	V _{GS} = 4.5V, I _D = 3.5A		40	55	mΩ
		V _{GS} = 2.5V, I _D = 2.0A		50	80	mΩ
Dynamic Characteristics^d						
Input Capacitance	C _{iss}	V _{DS} = 10V, V _{GS} = 0V, f = 1.0 MHz		380		pF
Output Capacitance	C _{oss}			90		pF
Reverse Transfer Capacitance	C _{rss}			60		pF
Switching Characteristics^d						
Turn-On Delay Time	t _{d(on)}	V _{DD} = 10V, I _D = 3.5A, V _{GS} = 4.5V, R _{GEN} = 6Ω		16		ns
Turn-On Rise Time	t _r			16		ns
Turn-Off Delay Time	t _{d(off)}			32		ns
Turn-Off Fall Time	t _f			7		ns
Total Gate Charge	Q _g	V _{DS} = 10V, I _D = 3.5A, V _{GS} = 3.3V		3.6		nC
Gate-Source Charge	Q _{gs}			1.0		nC
Gate-Drain Charge	Q _{gd}			1.2		nC
Drain-Source Diode Characteristics and Maximum Ratings						
Drain-Source Diode Forward Current ^b	I _S				1	A
Drain-Source Diode Forward Voltage ^c	V _{SD}	V _{GS} = 0V, I _S = 1A			1.1	V

P-CH Electrical Characteristics (T_A=25°C unless otherwise noted)

Parameter	Symbol	Test Condition	Min	Typ	Max	Units
Off Characteristics						
Drain-Source Breakdown Voltage	BV _{DSS}	V _{GS} = 0V, I _D = -250μA	-20			V
Zero Gate Voltage Drain Current	I _{DSS}	V _{DS} = -16V, V _{GS} = 0V			-1	μA
Gate Body Leakage Current, Forward	I _{GSSF}	V _{GS} = 12V, V _{DS} = 0V			100	nA
Gate Body Leakage Current, Reverse	I _{GSSR}	V _{GS} = -12V, V _{DS} = 0V			-100	nA
On Characteristics^c						
Gate Threshold Voltage	V _{GS(th)}	V _{GS} = V _{DS} , I _D = -250μA	-0.4		-1.2	V
Static Drain-Source On-Resistance	R _{DS(on)}	V _{GS} = -4.5V, I _D = -2.5A		85	100	mΩ
		V _{GS} = -2.5V, I _D = -1.5A		100	145	mΩ
Dynamic Characteristics^d						
Input Capacitance	C _{iss}	V _{DS} = -10V, V _{GS} = 0V, f = 1.0 MHz		375		pF
Output Capacitance	C _{oss}			90		pF
Reverse Transfer Capacitance	C _{rss}			60		pF
Switching Characteristics^d						
Turn-On Delay Time	t _{d(on)}	V _{DD} = -10V, I _D = -2.5A, V _{GS} = -4.5V, R _{GEN} = 3Ω		17		ns
Turn-On Rise Time	t _r			17		ns
Turn-Off Delay Time	t _{d(off)}			27		ns
Turn-Off Fall Time	t _f			7		ns
Total Gate Charge	Q _g	V _{DS} = -10V, I _D = -2.0A, V _{GS} = -3.3V		2.9		nC
Gate-Source Charge	Q _{gs}			0.46		nC
Gate-Drain Charge	Q _{gd}			1.19		nC
Drain-Source Diode Characteristics and Maximum Ratings						
Drain-Source Diode Forward Current ^b	I _S				-1	A
Drain-Source Diode Forward Voltage ^c	V _{SD}	V _{GS} = 0V, I _S = -1A			-1.1	V

N- Channel Typical Electrical and Thermal Characteristics

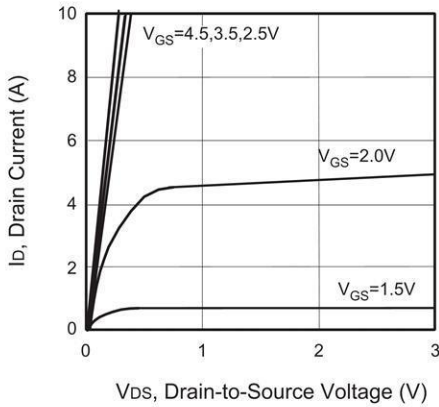

Figure 1. Output Characteristics

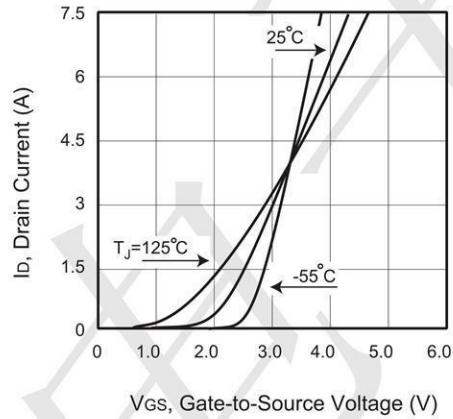

Figure 2. Transfer Characteristics

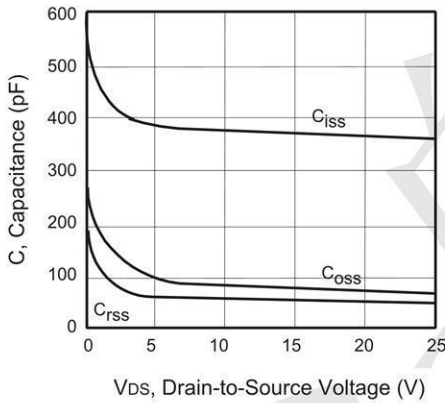

Figure 3. Capacitance

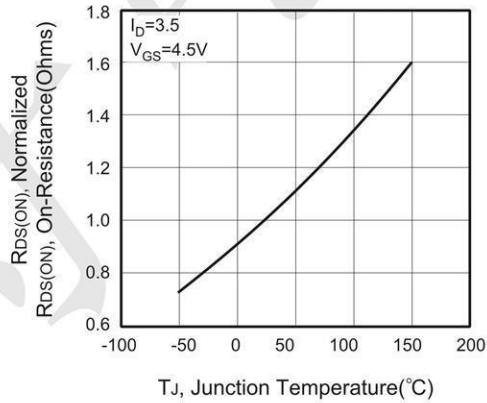

Figure 4. On-Resistance Variation with Temperature

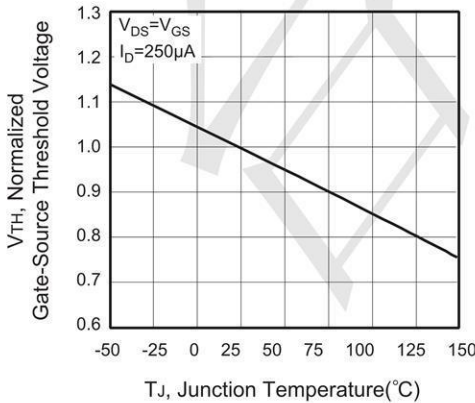

Figure 5. Gate Threshold Variation with Temperature

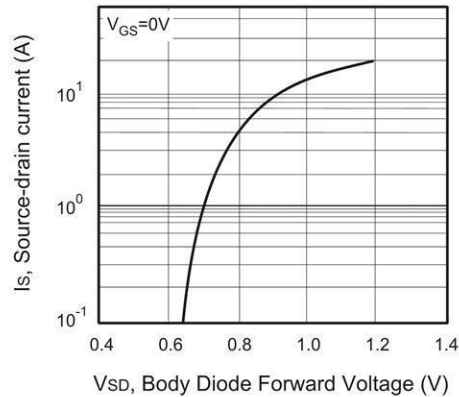

Figure 6. Body Diode Forward Voltage Variation with Source Current

P-CHANNEL

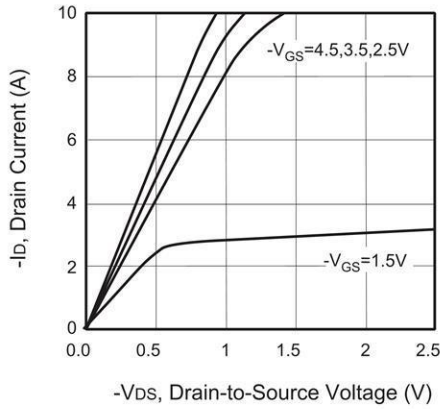

Figure 1. Output Characteristics

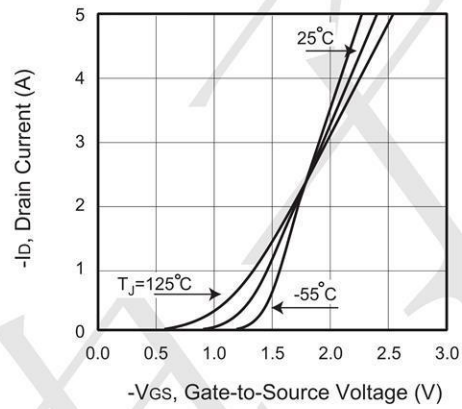

Figure 2. Transfer Characteristics

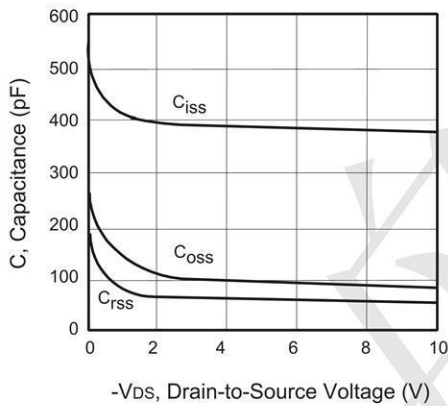

Figure 3. Capacitance

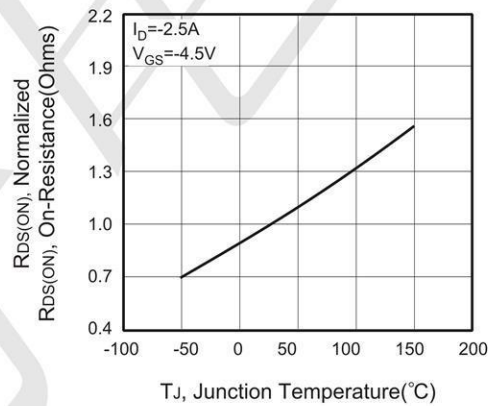

Figure 4. On-Resistance Variation with Temperature

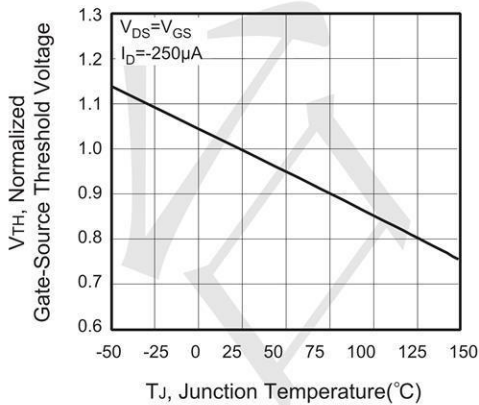

Figure 5. Gate Threshold Variation with Temperature

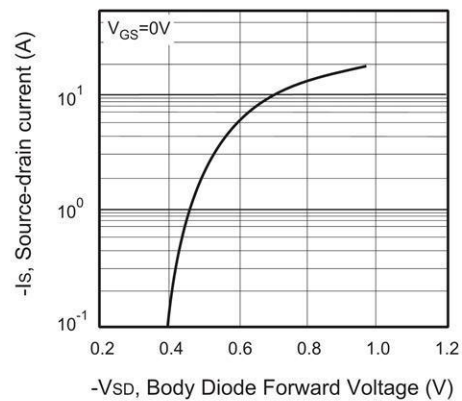

Figure 6. Body Diode Forward Voltage Variation with Source Current

N-CHANNEL

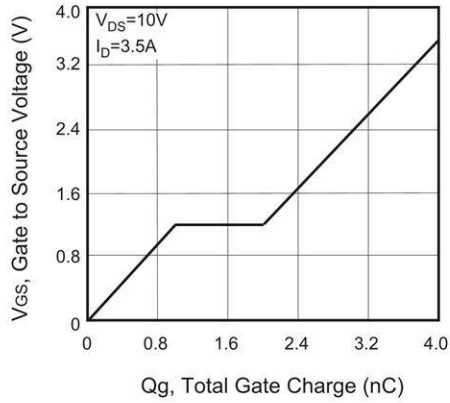

Figure 13. Gate Charge

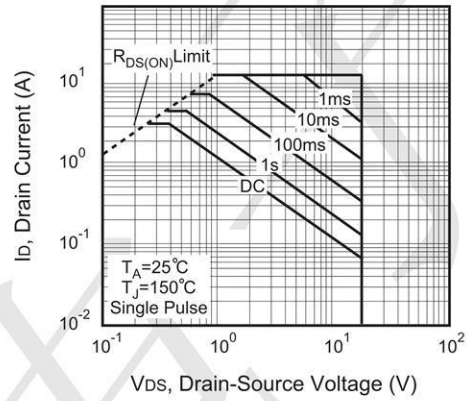

Figure 14. Maximum Safe Operating Area

P-CHANNEL

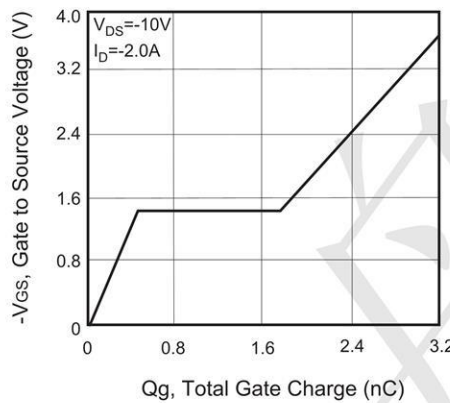

Figure 15. Gate Charge

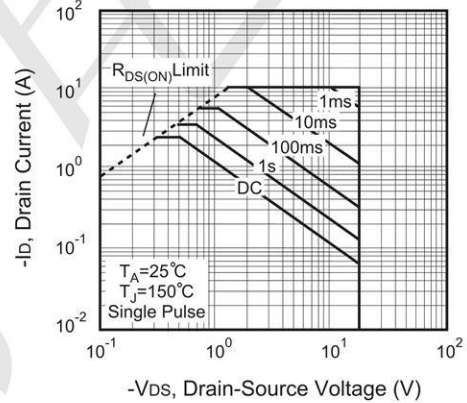

Figure 16. Maximum Safe Operating Area

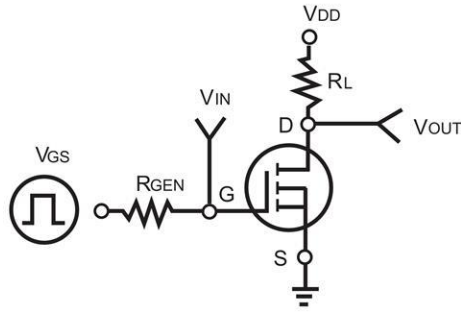

Figure 17. Switching Test Circuit

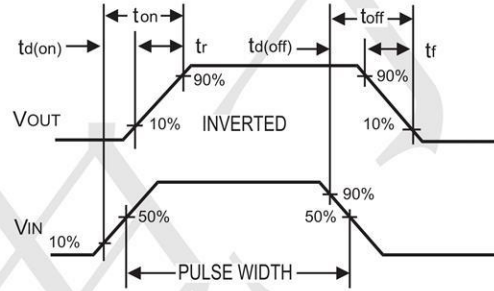

Figure 18. Switching Waveforms

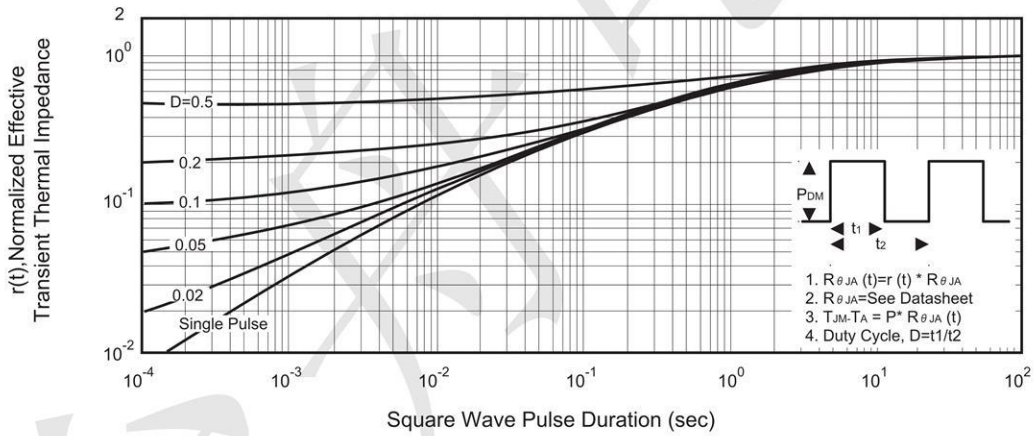

Figure 19. Normalized Thermal Transient Impedance Curve



TECH PUBLIC

—台丹电子—

FDC6420C

N and P-Channel Enhancement Mode Power MOSFET

www.sot23.com.tw

SOT23-6 Package Information

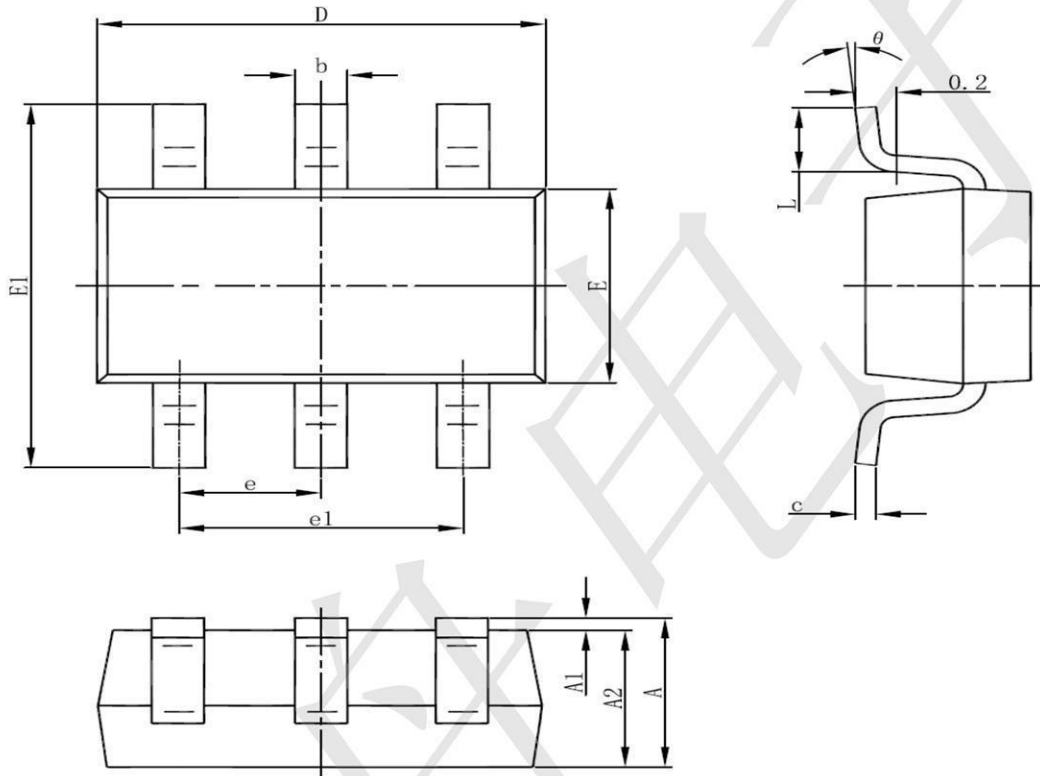

Symbol	Dimensions In Millimeters		Dimensions In Inches	
	Min	Max	Min	Max
A	1.050	1.250	0.041	0.049
A1	0.000	0.100	0.000	0.004
A2	1.050	1.150	0.041	0.045
b	0.300	0.500	0.012	0.020
c	0.100	0.200	0.004	0.008
D	2.820	3.020	0.111	0.119
E	1.500	1.700	0.059	0.067
E1	2.650	2.950	0.104	0.116
e	0.950(BSC)		0.037(BSC)	
e1	1.800	2.000	0.071	0.079
L	0.300	0.600	0.012	0.024
θ	0°	8°	0°	8°

X-ON Electronics

Largest Supplier of Electrical and Electronic Components

Click to view similar products for [MOSFET](#) category:

Click to view products by [TECH PUBLIC](#) manufacturer:

Other Similar products are found below :

[MCH3443-TL-E](#) [MCH6422-TL-E](#) [FDPF9N50NZ](#) [NTNS3A92PZT5G](#) [IRFD120](#) [JANTX2N5237](#) [2N7000](#) [2SK2464-TL-E](#) [AOD464](#) [2SJ277-DL-E](#) [2SK2267\(Q\)](#) [2SK2545\(Q,T\)](#) [405094E](#) [423220D](#) [MIC4420CM-TR](#) [VN1206L](#) [614234A](#) [715780A](#) [SSM6J414TU,LF\(T](#) [751625C](#) [IRS2092STRPBF-EL](#) [IPS70R2K0CEAKMA1](#) [BSF024N03LT3 G](#) [PSMN4R2-30MLD](#) [TK31J60W5,S1VQ\(O](#) [2SK2614\(TE16L1,Q\)](#) [DMN1017UCP3-7](#) [EFC2J004NUZTDG](#) [P85W28HP2F-7071](#) [DMN1053UCP4-7](#) [NTE2384](#) [NTE2969](#) [NTE6400A](#) [DMC2700UDMQ-7](#) [DMN2080UCB4-7](#) [DMN61D9UWQ-13](#) [US6M2GTR](#) [DMN31D5UDJ-7](#) [SSM6P54TU,LF](#) [DMP22D4UFO-7B](#) [IPS60R3K4CEAKMA1](#) [DMN1006UCA6-7](#) [DMN16M9UCA6-7](#) [STF5N65M6](#) [IRF40H233XTMA1](#) [IPSA70R950CEAKMA1](#) [IPSA70R2K0CEAKMA1](#) [STU5N65M6](#) [C3M0021120D](#) [DMN6022SSD-13](#)