

## GENERAL FEATURES

MOSFET		
$V_{(BR)DSS}$	$R_{DS(on)max}$	$I_D$
-60V	110mΩ @ $V_{GS} = -10V$	-3.3A
	130mΩ @ $V_{GS} = -4.5V$	-2.8A
SCHOTTKY DIODE		
$V_R$	$V_{Fmax}$	$I_o$
45V	450mV @ $I_F = 1A$	2.0A
	600mV @ $I_F = 2A$	

## Application

- DC-DC Converters
- Power Management Functions
- Backlighting

## Package and Pin Configuration

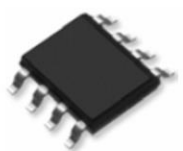

SOP-8 top view

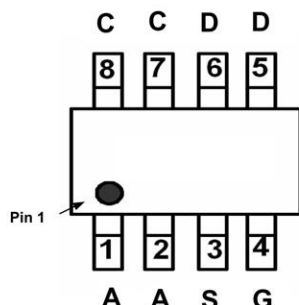

## Circuit diagram

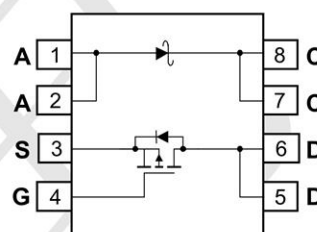

## Marking:

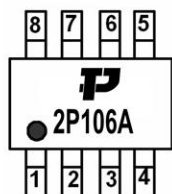

## Absolute Maximum Ratings ( $T_A=25^\circ\text{C}$ unless otherwise noted)

Characteristic	Symbol	Value	Units
Drain-Source Voltage	$V_{DSS}$	-60	V
Gate-Source Voltage	$V_{GSS}$	$\pm 20$	V
Drain Current (Note 6) $V_{GS} = -10V$ $t < 10s$	$I_D$	$T_A = +25^\circ\text{C}$	-4.5
		$T_A = +70^\circ\text{C}$	-3.6
Maximum Body Diode Forward Current (Note 6)	$I_S$	-2.1	A
Pulsed Drain Current (10μs pulse, duty cycle = 1%)	$I_{DM}$	-19	A
Avalanche Current (Notes 7) $L = 0.1mH$	$I_{AS}$	-17.6	A
Avalanche Energy (Notes 7) $L = 0.1mH$	$E_{AS}$	15.4	mJ

## Thermal Characteristic

Characteristic	Symbol	Value	Units
Total Power Dissipation (Note 5)	$P_D$	1.5	W
Thermal Resistance, Junction to Ambient (Note 5)	$R_{\theta JA}$	Steady State	80
		$t < 10s$	48
Total Power Dissipation (Note 6)	$P_D$	2.0	W
Thermal Resistance, Junction to Ambient (Note 6)	$R_{\theta JA}$	Steady State	61
		$t < 10s$	37
Thermal Resistance, Junction to Case	$R_{\theta JC}$	6.4	$^\circ\text{C/W}$
Operating and Storage Temperature Range	$T_J, T_{STG}$	-55 to +150	$^\circ\text{C}$

## Electrical Characteristics (T<sub>A</sub>=25°C unless otherwise noted)

### P-Channel Mosfet

Characteristic	Symbol	Min	Typ	Max	Unit	Test Condition
<b>OFF CHARACTERISTICS (Note 8)</b>						
Drain-Source Breakdown Voltage	BV <sub>DSS</sub>	-60	—	—	V	V <sub>GS</sub> = 0V, I <sub>D</sub> = -250μA
Zero Gate Voltage Drain Current	I <sub>DSS</sub>	—	—	-1	μA	V <sub>DS</sub> = -48V, V <sub>GS</sub> = 0V
Gate-Source Leakage	I <sub>GSS</sub>	—	—	100	nA	V <sub>GS</sub> = ±16V, V <sub>DS</sub> = 0V
<b>ON CHARACTERISTICS (Note 8)</b>						
Gate Threshold Voltage	V <sub>GS(th)</sub>	-1	-1.7	-3	V	V <sub>DS</sub> = V <sub>GS</sub> , I <sub>D</sub> = -250μA
Static Drain-Source On-Resistance	R <sub>DS(on)</sub>	—	86	110	mΩ	V <sub>GS</sub> = -10V, I <sub>D</sub> = -3A
		—	98	130		V <sub>GS</sub> = -4.5V, I <sub>D</sub> = -2.5A
Diode Forward Voltage	V <sub>SD</sub>	—	-0.7	-1.2	V	V <sub>GS</sub> = 0V, I <sub>S</sub> = -1A
<b>DYNAMIC CHARACTERISTICS (Note 9)</b>						
Input Capacitance	C <sub>iss</sub>	—	1030	—	pF	V <sub>DS</sub> = -30V, V <sub>GS</sub> = 0V, f = 1.0MHz
Output Capacitance	C <sub>oss</sub>	—	49.1	—		
Reverse Transfer Capacitance	C <sub>rss</sub>	—	38.7	—		
Gate Resistance	R <sub>G</sub>	—	13.6	—	Ω	V <sub>DS</sub> = 0V, V <sub>GS</sub> = 0V, f = 1.0MHz
Total Gate Charge (V <sub>GS</sub> = -4.5V)	Q <sub>g</sub>	—	9.5	—	nC	V <sub>DS</sub> = -30V, I <sub>D</sub> = -5A
Total Gate Charge (V <sub>GS</sub> = -10V)	Q <sub>g</sub>	—	19.4	—		
Gate-Source Charge	Q <sub>gs</sub>	—	2.3	—		
Gate-Drain Charge	Q <sub>gd</sub>	—	3.6	—		
Turn-On Delay Time	t <sub>D(on)</sub>	—	3.7	—	ns	V <sub>GS</sub> = -10V, V <sub>DS</sub> = -30V, R <sub>GEN</sub> = 6Ω, I <sub>D</sub> = -5A
Turn-On Rise Time	t <sub>r</sub>	—	6.3	—		
Turn-Off Delay Time	t <sub>D(off)</sub>	—	58.7	—		
Turn-Off Fall Time	t <sub>f</sub>	—	26.1	—		
Body Diode Reverse Recovery Time	t <sub>rr</sub>	—	14.85	—	ns	I <sub>S</sub> = -5A, di/dt = 100A/μs
Body Diode Reverse Recovery Charge	Q <sub>rr</sub>	—	8.8	—	nC	I <sub>S</sub> = -5A, di/dt = 100A/μs

## Electrical Characteristics (T<sub>A</sub>=25°C unless otherwise noted)

### Schottky Diode

Characteristic	Symbol	Min	Typ	Max	Unit	Test Condition
Reverse Breakdown Voltage (Note 8)	V <sub>(BR)R</sub>	45	—	—	V	I <sub>R</sub> = 1mA
Forward Voltage (Note 8)	V <sub>F</sub>	—	—	0.45	V	I <sub>F</sub> = 1A
		—	0.48	0.6		I <sub>F</sub> = 2A
Reverse Current (Note 8)	I <sub>R</sub>	—	30	80	μA	V <sub>R</sub> = 45V

**Typical Electrical and Thermal Characteristics**

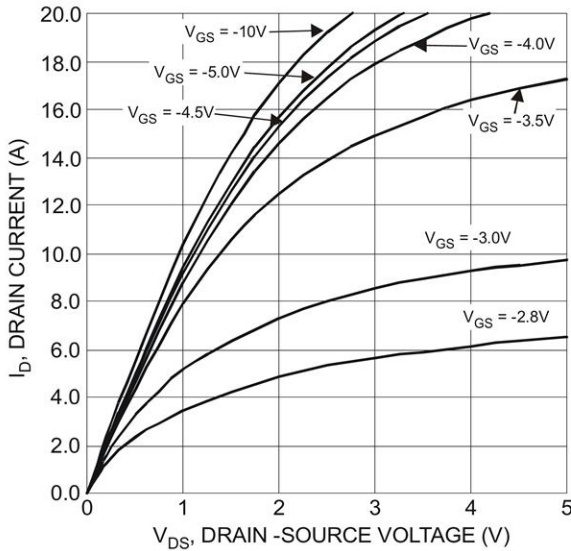

Figure 1 Typical Output Characteristics

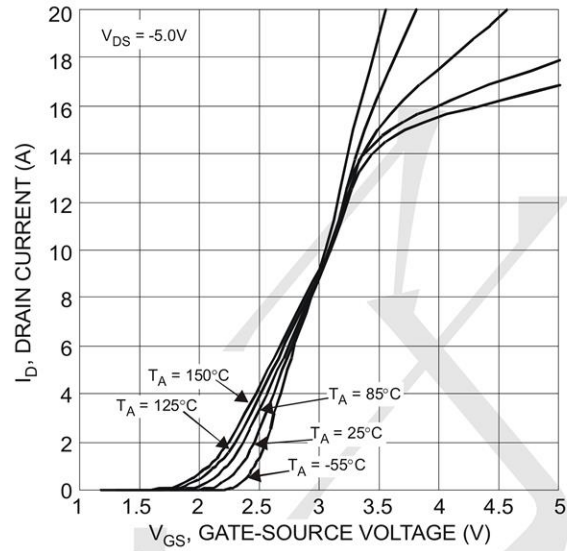

Figure 2 Typical Transfer Characteristics

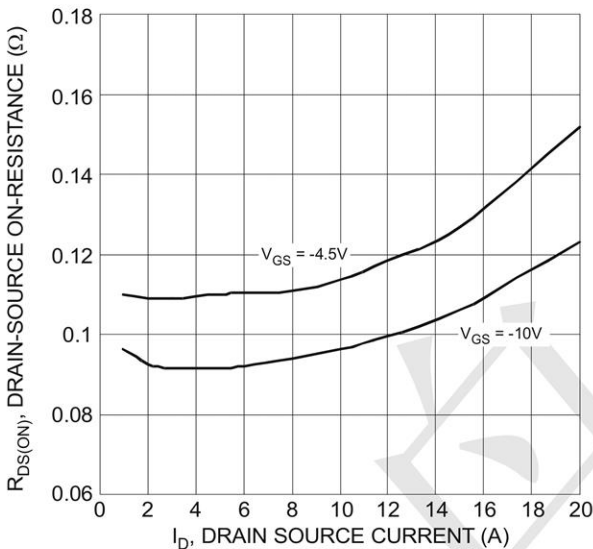

Figure 3 Typical On-Resistance vs. Drain Current and Gate Voltage

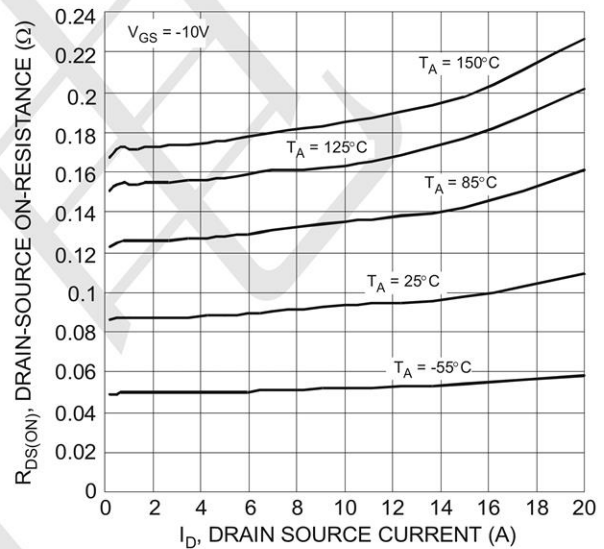

Figure 4 Typical On-Resistance vs. Drain Current and Temperature

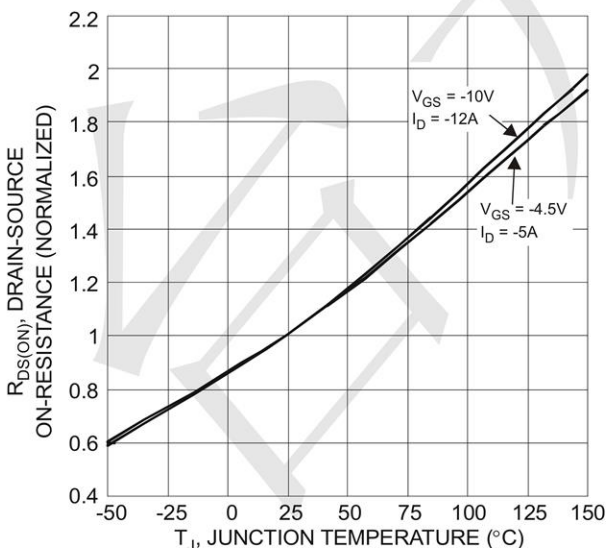

Figure 5 On-Resistance Variation with Temperature

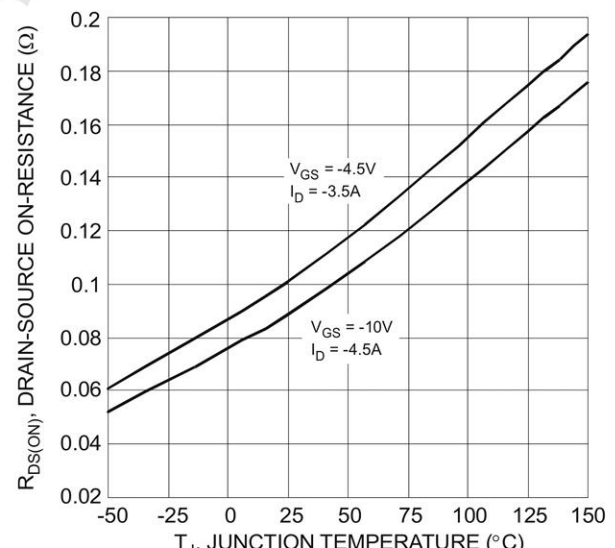

Figure 6 On-Resistance Variation with Temperature

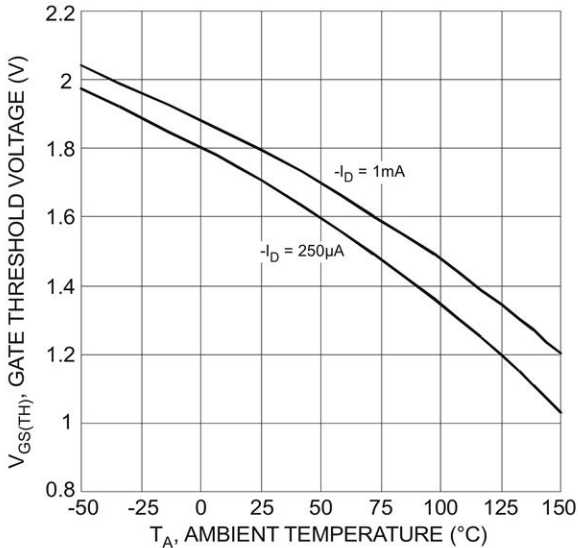

Figure 7 Gate Threshold Variation vs. Ambient Temperature

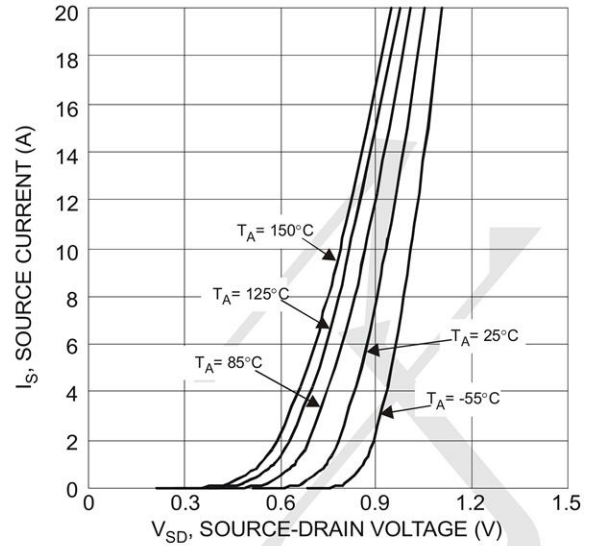

Figure 8 Diode Forward Voltage vs. Current

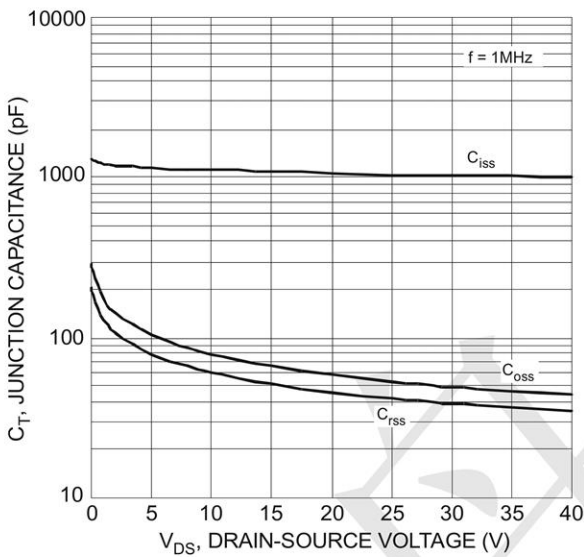

Figure 9 Typical Junction Capacitance

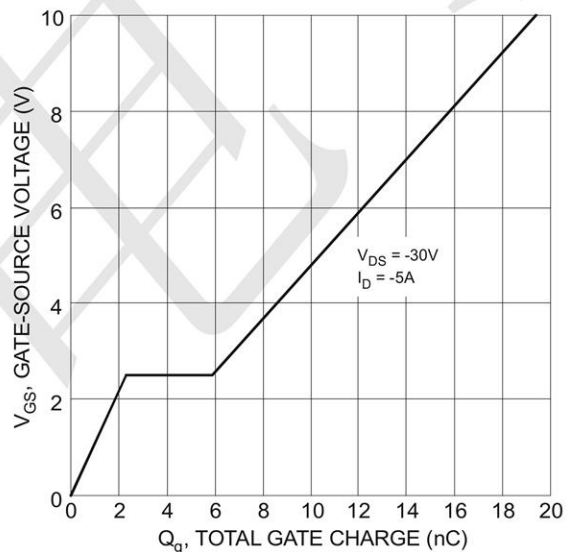

Figure 10 Gate-Charge Characteristics

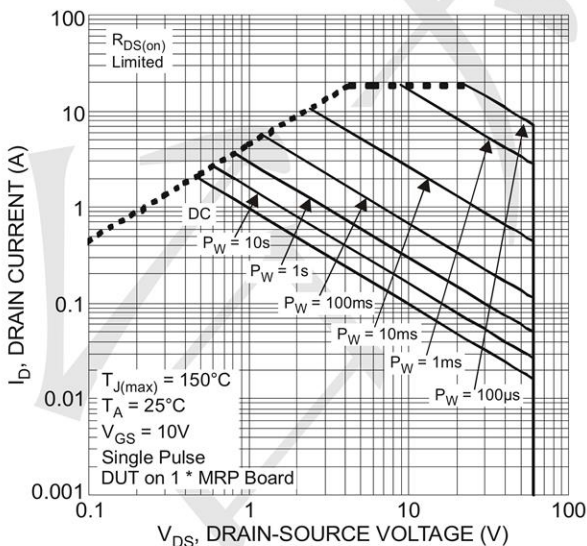
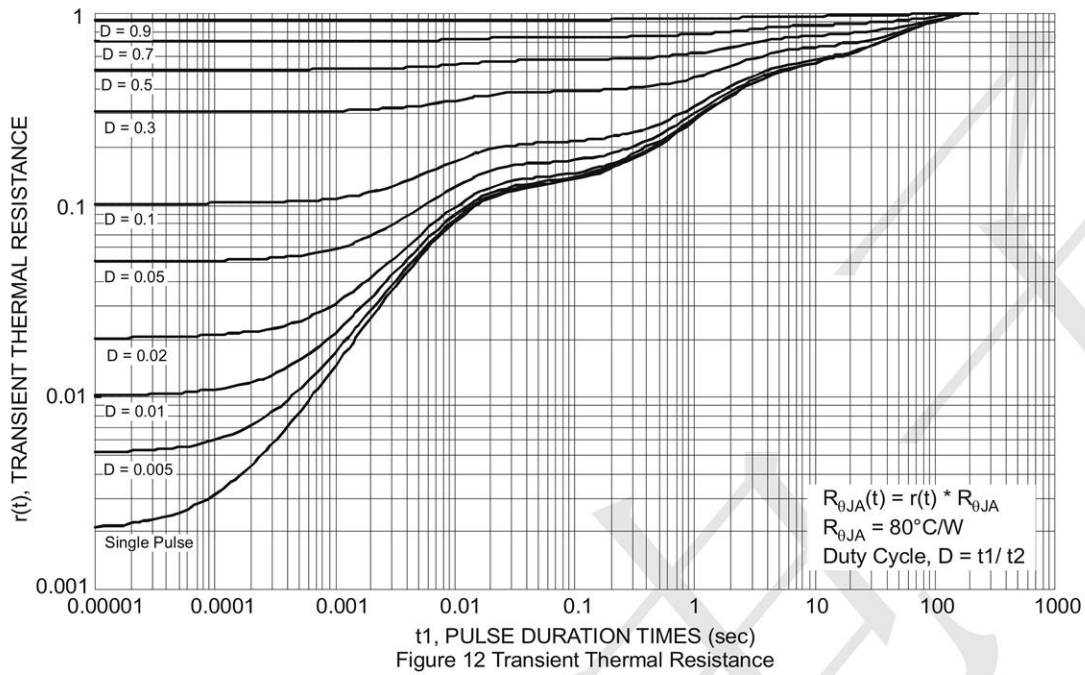
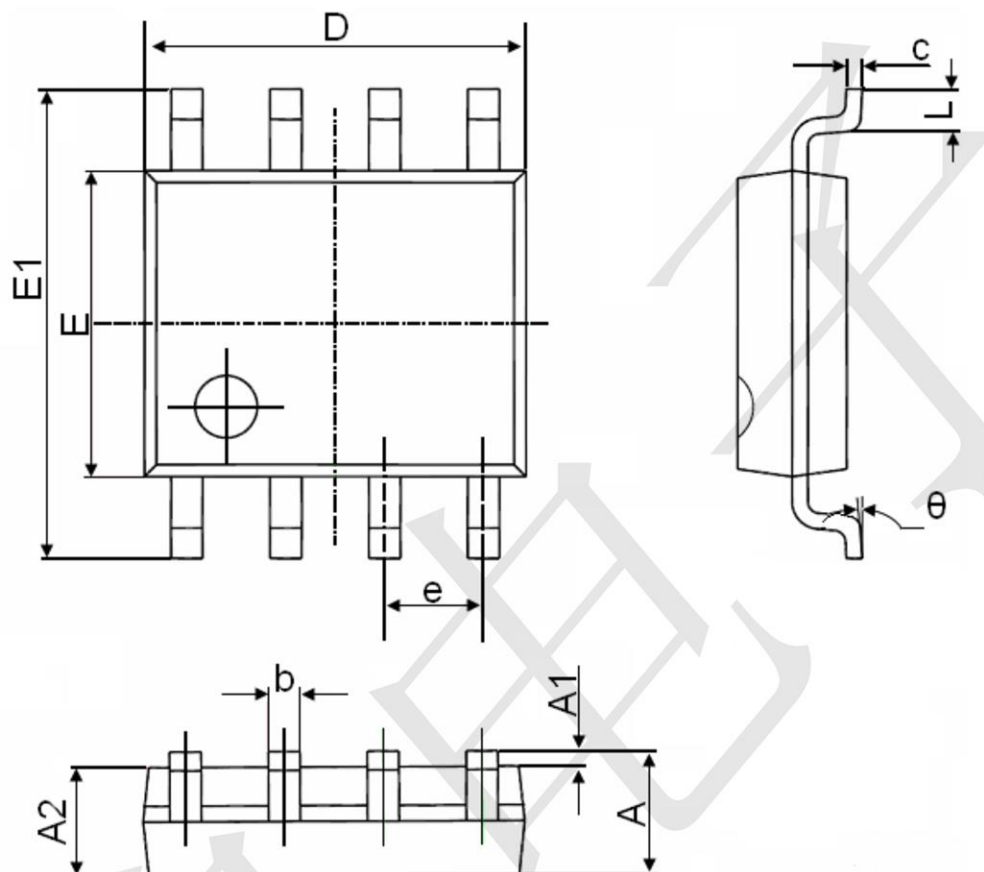

Figure 11 SOA, Safe Operation Area



**SOP-8 Package Information**



Symbol	Dimensions In Millimeters		Dimensions In Inches	
	Min.	Max.	Min.	Max.
A	1.350	1.750	0.053	0.069
A1	0.100	0.250	0.004	0.010
A2	1.350	1.550	0.053	0.061
b	0.330	0.510	0.013	0.020
c	0.170	0.250	0.006	0.010
D	4.700	5.100	0.185	0.200
E	3.800	4.000	0.150	0.157
E1	5.800	6.200	0.228	0.244
e	1.270(BSC)		0.050(BSC)	
L	0.400	1.270	0.016	0.050
θ	0°	8°	0°	8°

## X-ON Electronics

Largest Supplier of Electrical and Electronic Components

*Click to view similar products for [MOSFET](#) category:*

*Click to view products by [TECH PUBLIC](#) manufacturer:*

Other Similar products are found below :

[IRFD120](#) [JANTX2N5237](#) [2SK2267\(Q\)](#) [BUK455-60A/B](#) [TK100A10N1,S4X\(S](#) [MIC4420CM-TR](#) [VN1206L](#) [NDP4060](#) [SI4482DY](#)  
[IRS2092STRPBF-EL](#) [IPS70R2K0CEAKMA1](#) [TK31J60W5,S1VQ\(O](#) [TK31J60W,S1VQ\(O](#) [TK16J60W,S1VQ\(O](#) [2SK2614\(TE16L1,Q\)](#)  
[DMN1017UCP3-7](#) [EFC2J004NUZTDG](#) [P85W28HP2F-7071](#) [DMN1053UCP4-7](#) [NTE2384](#) [DMC2700UDMQ-7](#) [DMN2080UCB4-7](#)  
[DMN61D9UWQ-13](#) [US6M2GTR](#) [DMN31D5UDJ-7](#) [DMP22D4UFO-7B](#) [IPS60R3K4CEAKMA1](#) [DMN1006UCA6-7](#) [DMN16M9UCA6-7](#)  
[STF5N65M6](#) [IRF40H233XTMA1](#) [STU5N65M6](#) [DMN6022SSD-13](#) [DMN13M9UCA6-7](#) [DMTH10H4M6SPS-13](#) [IPS60R360PFD7SAKMA1](#)  
[DMN2990UFB-7B](#) [SSM3K35CT,L3F](#) [IPLK60R1K0PFD7ATMA1](#) [2N7002W-G](#) [MCAC30N06Y-TP](#) [IPWS65R035CFD7AXKSA1](#)  
[MCQ7328-TP](#) [SSM3J143TU,LXHF](#) [DMN12M3UCA6-7](#) [PJMF280N65E1\\_T0\\_00201](#) [PJMF380N65E1\\_T0\\_00201](#)  
[PJMF280N60E1\\_T0\\_00201](#) [PJMF600N65E1\\_T0\\_00201](#) [PJMF900N65E1\\_T0\\_00201](#)