

Product Summary

- RDS(on) 120mΩ at VGS = 4.5 V (Typ)
- RDS(on) 160mΩ at VGS = 2.5 V (Typ)
- RDS(on) 220mΩ at VGS = 2.5 V (Typ)
- ID (A) ± 1.3
- Configuration Level-Shif

Application

- Battery Packs
- Battery-Powered Portable Equipment
- Cellular and Cordless Telephones

Package and Pin Configuration

Circuit diagram

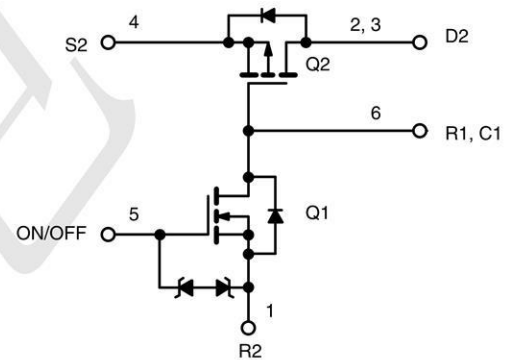
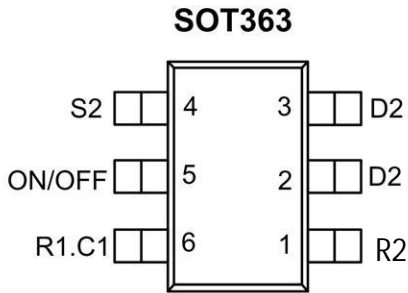

Marking:



VCQ= is Part Number ,Fixed

TP= TECH PUBLIC,Fixed

Absolute Maximum Ratings (TA=25°C unless otherwise noted)

PARAMETER	SYMBOL	Ratings	UNITS
Drain-source voltage (D2-S2)	V _{DS}	-20	V
Input Voltage Range	V _{IN}	20	V
On/Off Voltage Range	V _{ON} /V _{OFF}	8	V
Continuous Load Current	IL	1.3	A
Pulsed Load Current	ILM	3.9	A
Continuous intrinsic diode conduction	Is	0.4	A
Maximum power dissipation	P _D	1.0	W
Operating Junction and Storage Temperature Range	T _J ,T _{STG}	-55~150	°C
ESD, MIL-STD-883D HBM (100pF/1.5kohm) (Von/off pin)	V _{ESD}	2	kV
Typical Junction to Ambient ^(Note 2)	R _{θJA}	250	°C/W

Electrical Characteristics ($T_A = 25^\circ\text{C}$ unless otherwise noted)

PARAMETER	SYMBOL	TEST CONDITION	MIN.	TYP.	MAX.	UNITS
Off Characteristics						
Leakage Current	I_{FL}	$V_{IN}=8\text{ V}, V_{ON}/V_{OFF}=0\text{ V}$	-	-	1	μA
Diode Forward Voltage	V_{SD}	$I_S=-0.4\text{ A}$	0.4	0.6	1.1	V
On Characteristics						
Input voltage range	V_{in}			-	20	V
Drain to source breakdown voltage (Q2)	V_{ds}	$V_{GS} = 0\text{ V}, I_D = -250\ \mu\text{A}$	-20	-		V
Drain-Source On-State Resistance (Q2)	$R_{DS(on)}$	$V_{ON/OFF} = 1.5\text{ V}, V_{IN} = 4.5\text{ V}, I_D = 1.2\text{ A}$		120	150	m Ω
		$V_{ON/OFF} = 1.5\text{ V}, V_{IN} = 2.5\text{ V}, I_D = 1\text{ A}$		160	210	
		$V_{ON/OFF} = 1.5\text{ V}, V_{IN} = 1.8\text{ V}, I_D = 0.7\text{ A}$		220	270	
Load Current	I_L	$V_{drop}=0.2\text{ V}, V_{in}=5\text{ V}, V_{on/off}=1.5\text{ V}$	1.0	-		A
		$V_{drop}=0.2\text{ V}, V_{in}=5\text{ V}, V_{on/off}=1.5\text{ V}$	1.0	-		

Typical Application Circuit

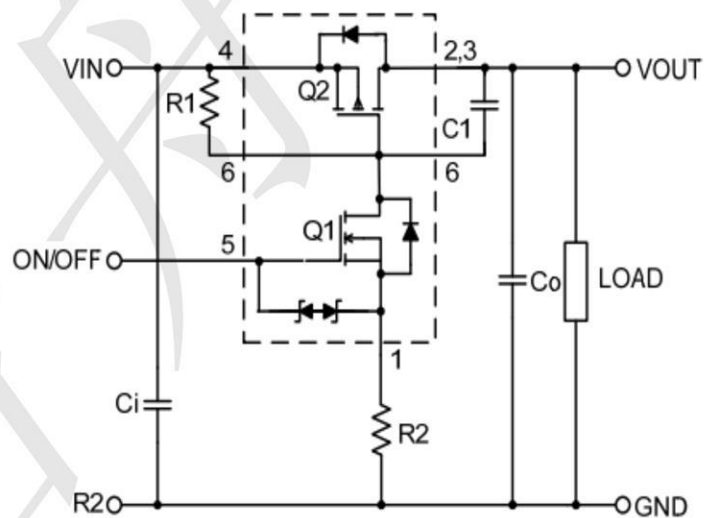

COMPONENTS		
R1	Pull-Up Resistor	Typical 10k Ω to 1M Ω *
R2	Optional Slew-Rate Control	Typical 0 to 100k Ω
C1	Optional Slew-Rate Control	Typical 1000pF

Typical Operating Characteristics

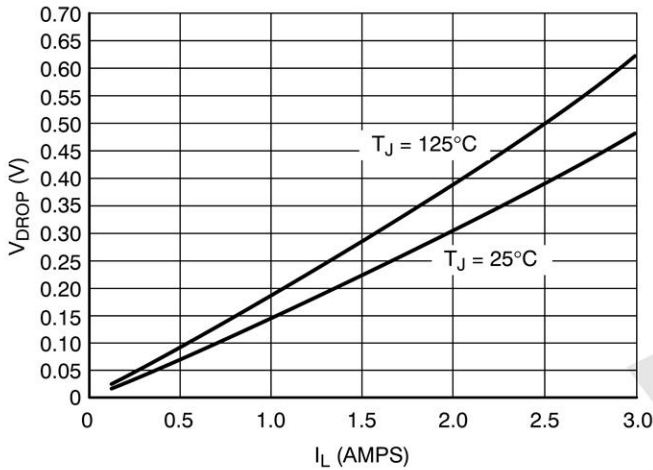

Figure 2. V_{drop} vs. I_L @ $V_{in} = 2.5$ V

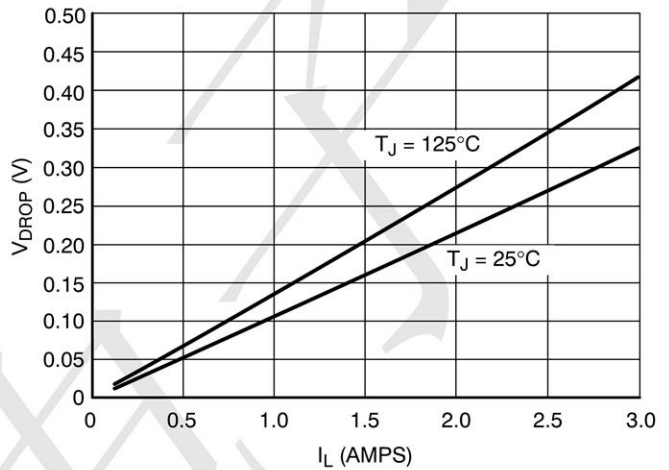

Figure 3. V_{drop} vs. I_L @ $V_{in} = 4.5$ V

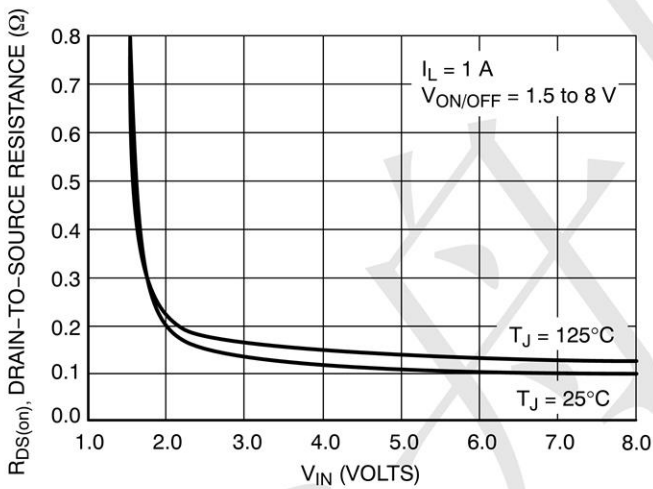

Figure 4. On-Resistance vs. Input Voltage

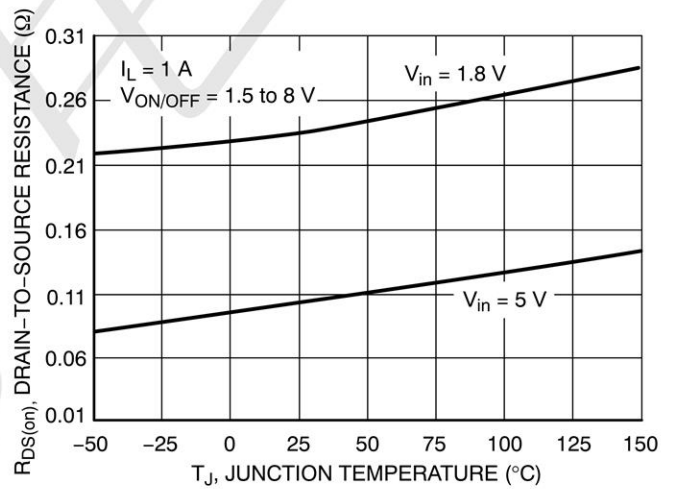

Figure 5. On-Resistance Variation with Temperature

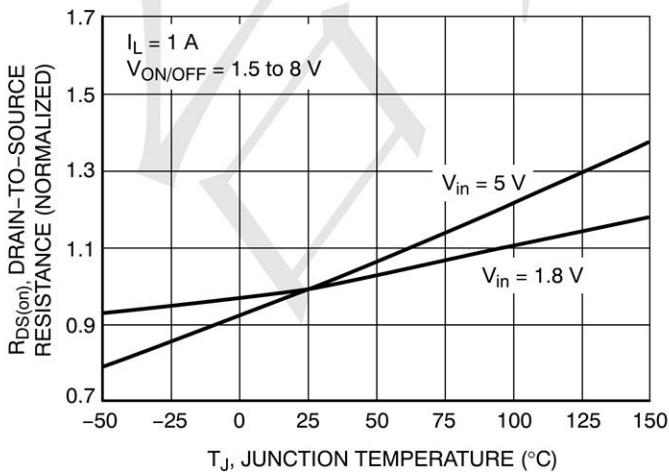

Figure 6. Normalized On-Resistance Variation with Temperature

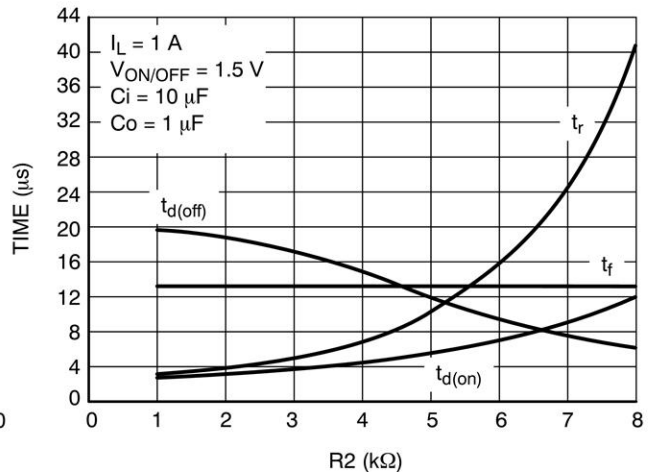

Figure 7. Switching Variation R_2 @ $V_{in} = 4.5$ V, $R_1 = 20$ kΩ

TYPICAL PERFORMANCE CURVES ($T_J = 25^\circ\text{C}$ unless otherwise noted)

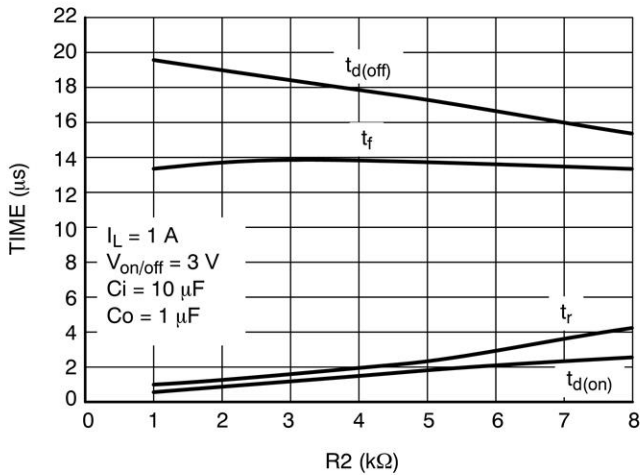

Figure 8. Switching Variation
R2 @ $V_{in} = 4.5\text{ V}$, $R_1 = 20\text{ k}\Omega$

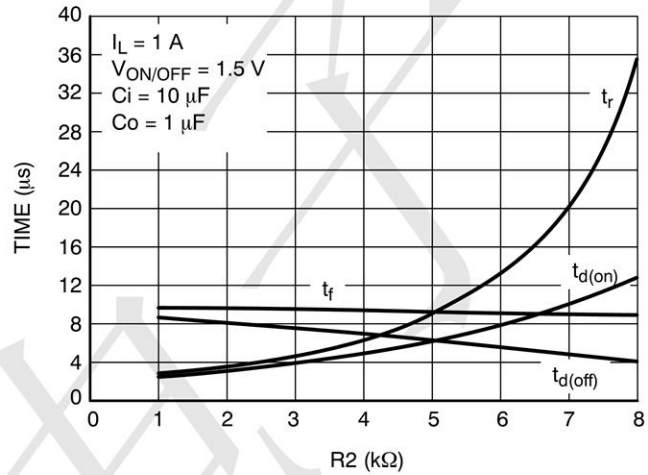

Figure 9. Switching Variation
R2 @ $V_{in} = 2.5\text{ V}$, $R_1 = 20\text{ k}\Omega$

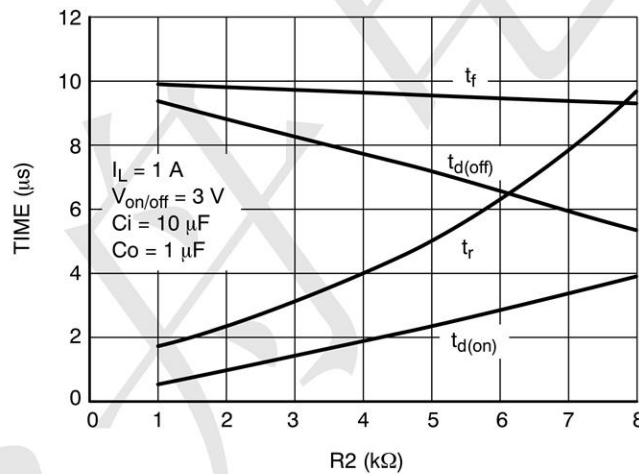

Figure 10. Switching Variation
R2 @ $V_{in} = 2.5\text{ V}$, $R_1 = 20\text{ k}\Omega$

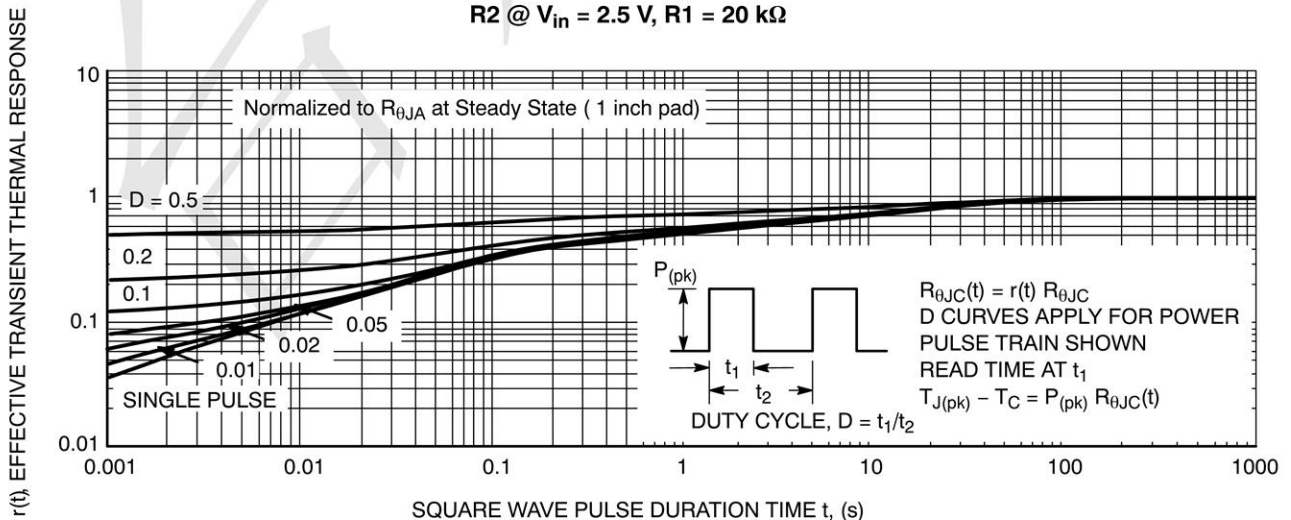
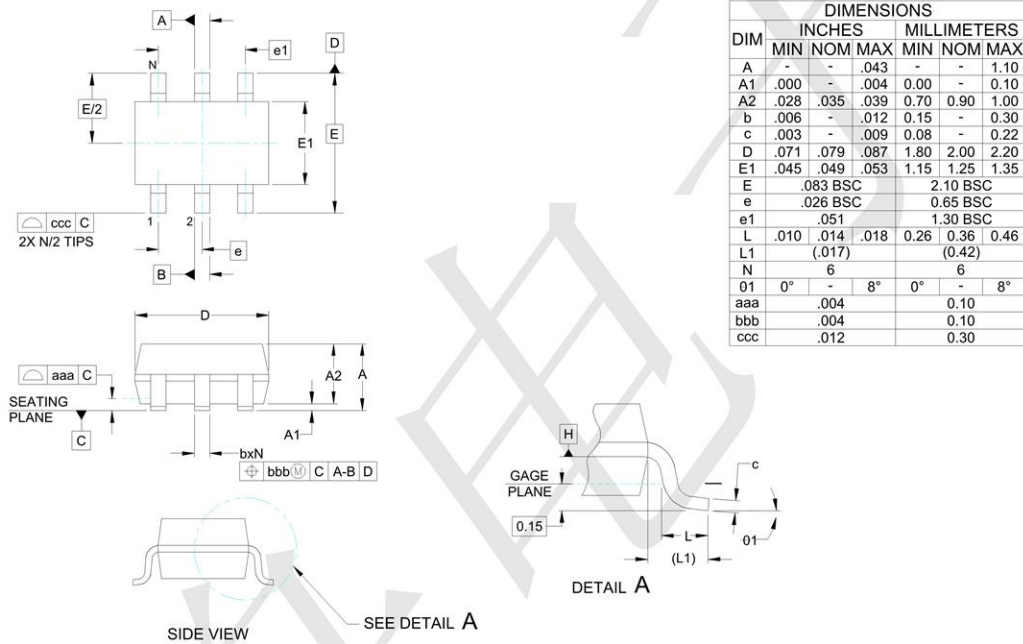
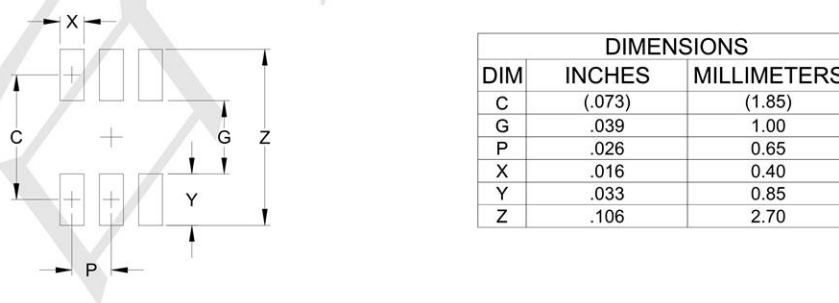

Figure 11. FET Thermal Response

Outline Drawing - SOT-363



Land Pattern - SOT-363



X-ON Electronics

Largest Supplier of Electrical and Electronic Components

Click to view similar products for [Power Switch ICs - Power Distribution](#) *category:*

Click to view products by [TECH PUBLIC](#) *manufacturer:*

Other Similar products are found below :

[NCP45520IMNTWG-L](#) [TCK111G,LF\(S](#) [FPF1018](#) [DS1222](#) [TCK2065G,LF](#) [SZNCP3712ASNT3G](#) [TLE7244SL](#) [MIC2033-05BYMT-T5](#)
[MIC2033-12AYMT-T5](#) [MIC2033-05BYM6-T5](#) [AP22811BW5-7](#) [SLG5NT1437VTR](#) [SZNCP3712ASNT1G](#) [DML1008LDS-7](#)
[KTS1640QGDV-TR](#) [KTS1641QGDV-TR](#) [BTS500101TADATMA2](#) [NCV459MNWTBG](#) [NCP4545IMNTWG-L](#) [NCV8412ASTT1G](#)
[NCV8412ASTT3G](#) [FPF2260ATMX](#) [SLG5NT1765V](#) [SLG5NT1757V](#) [SLG59M1557VTR](#) [BD2222G-GTR](#) [NCP45780IMN24RTWG](#)
[NCP45540IMNTWG-L](#) [FDC6324L-TP](#) [FDC6326L-TP](#) [FDC6330L-TP](#) [U6210](#) [U25135](#) [U62153](#) [U6513BS](#) [U62133](#) [U6773H](#) [U62143S](#)
[U6315BS](#) [U6513B](#) [U6110](#) [SL3405S](#) [BTS7040-2EPA](#) [SY6282ACC](#) [WS3222D-8/TR](#) [DP25136C](#) [DK5V100R20C](#) [SY6281AAC](#)
[DK5V45R25P](#) [DK5V100R10M](#)