

GENERAL FEATURES

- $V_{DS}=60V, I_D=6A$
- $R_{DS(ON)} < 35m\Omega @ V_{GS}=10V$
- $R_{DS(ON)} < 45m\Omega @ V_{GS}=4.5V$

Application

- Load/Power Switching
- Interfacing Switching
- Logic Level Shift

Package and Pin Configuration

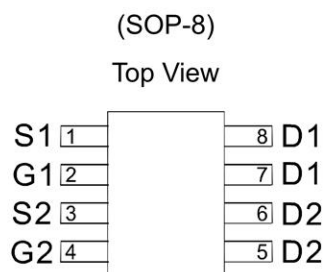

Circuit diagram

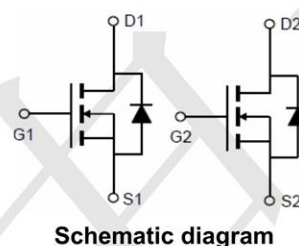

Marking:

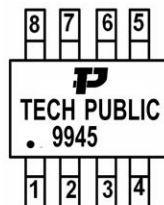

Absolute Maximum Ratings ($T_A=25^\circ C$ unless otherwise noted)

| Parameter | Symbol | Limit | Unit |
|--|--------------------|------------|------------|
| Drain-Source Voltage | V_{DS} | 60 | V |
| Gate-Source Voltage | V_{GS} | ± 20 | V |
| Drain Current-Continuous | I_D | 6 | A |
| Drain Current-Continuous($T_C=100^\circ C$) | $I_D(100^\circ C)$ | 3.5 | A |
| Pulsed Drain Current | I_{DM} | 24 | A |
| Maximum Power Dissipation | P_D | 2 | W |
| Operating Junction and Storage Temperature Range | T_J, T_{STG} | -55 To 150 | $^\circ C$ |

Thermal Characteristic

| | | | |
|---|-----------------|------|--------------|
| Thermal Resistance, Junction-to-Ambient ^(Note 2) | $R_{\theta JA}$ | 62.5 | $^\circ C/W$ |
|---|-----------------|------|--------------|

Electrical Characteristics (T_A=25°C unless otherwise noted)

| Parameter | Symbol | Condition | Min | Typ | Max | Unit |
|---|---------------------|--|-----|-----|------|------|
| Off Characteristics | | | | | | |
| Drain-Source Breakdown Voltage | BV _{DSS} | V _{GS} =0V, I _D =250μA | 60 | - | - | V |
| Zero Gate Voltage Drain Current | I _{DSS} | V _{DS} =60V, V _{GS} =0V | - | - | 1 | μA |
| Gate-Body Leakage Current | I _{GSS} | V _{GS} =±20V, V _{DS} =0V | - | - | ±100 | nA |
| On Characteristics (Note 3) | | | | | | |
| Gate Threshold Voltage | V _{GS(th)} | V _{DS} =V _{GS} , I _D =250μA | 1.2 | 1.6 | 2.5 | V |
| Drain-Source On-State Resistance | R _{DS(ON)} | V _{GS} =10V, I _D =5A | - | 26 | 35 | mΩ |
| | R _{DS(ON)} | V _{GS} =4.5V, I _D =5A | - | 32 | 45 | mΩ |
| Forward Transconductance | g _{FS} | V _{DS} =5V, I _D =5A | 11 | - | - | S |
| Dynamic Characteristics (Note 4) | | | | | | |
| Input Capacitance | C _{iss} | V _{DS} =30V, V _{GS} =0V, F=1.0MHz | - | 979 | - | PF |
| Output Capacitance | C _{oss} | | - | 120 | - | PF |
| Reverse Transfer Capacitance | C _{rss} | | - | 100 | - | PF |
| Switching Characteristics (Note 4) | | | | | | |
| Turn-on Delay Time | t _{d(on)} | V _{DD} =30V, R _L =6.7Ω V _{GS} =10V, R _G =3Ω | - | 5.2 | - | nS |
| Turn-on Rise Time | t _r | | - | 3 | - | nS |
| Turn-Off Delay Time | t _{d(off)} | | - | 17 | - | nS |
| Turn-Off Fall Time | t _f | | - | 2.5 | - | nS |
| Total Gate Charge | Q _g | V _{DS} =30V, I _D =5A, V _{GS} =10V | - | 22 | - | nC |
| Gate-Source Charge | Q _{gs} | | - | 3.3 | - | nC |
| Gate-Drain Charge | Q _{gd} | | - | 5.2 | - | nC |
| Drain-Source Diode Characteristics | | | | | | |
| Diode Forward Voltage (Note 3) | V _{SD} | V _{GS} =0V, I _S =5A | - | - | 1.2 | V |
| Diode Forward Current (Note 2) | I _S | | - | - | 5 | A |
| Forward Turn-On Time | t _{on} | Intrinsic turn-on time is negligible (turn-on is dominated by LS+LD) | | | | |

Typical Electrical and Thermal Characteristics

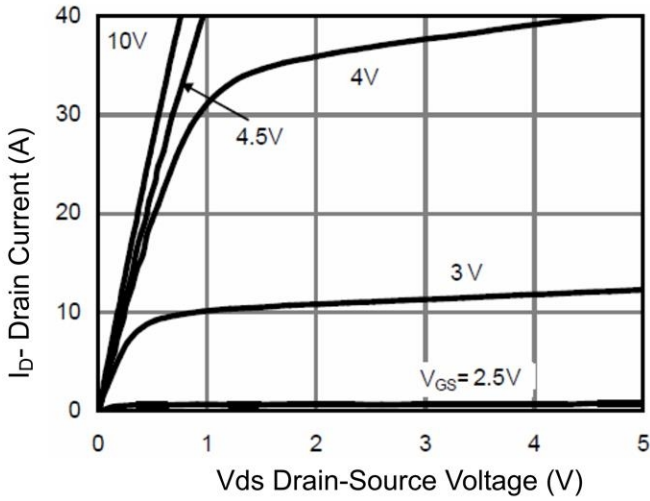

Figure 1 Output Characteristics

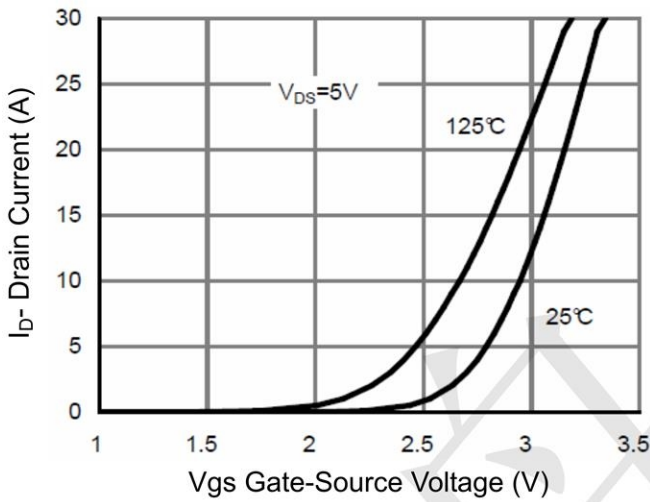

Figure 2 Transfer Characteristics

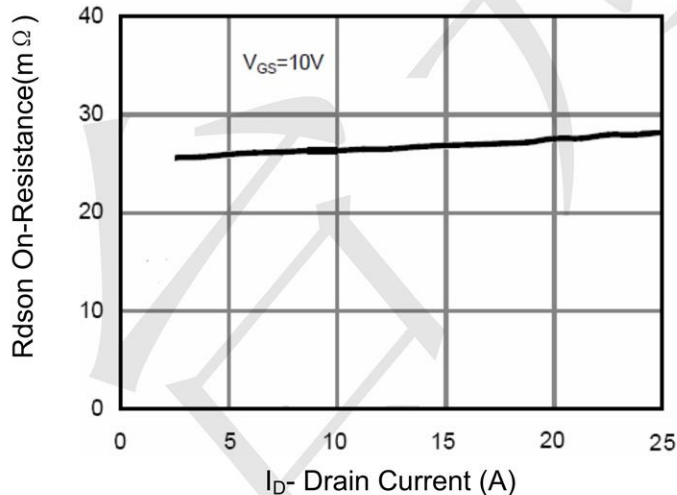

Figure 3 Rdson- Drain Current

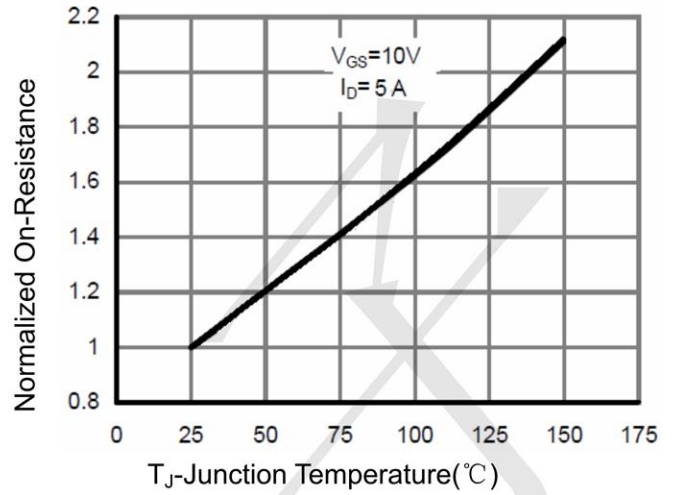

Figure 4 Rdson-Junction Temperature

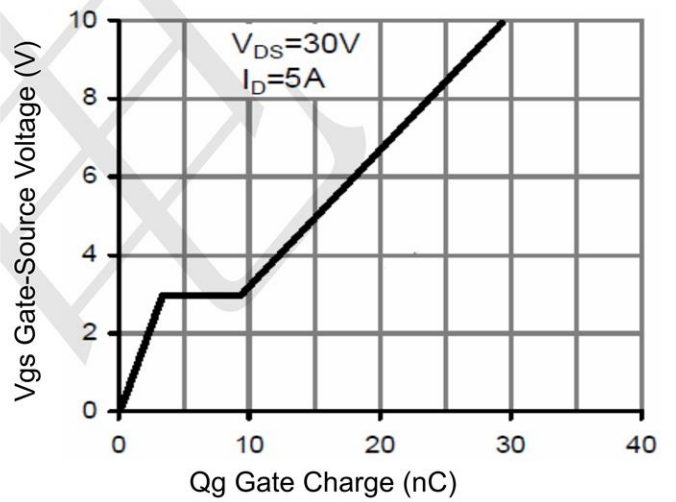

Figure 5 Gate Charge

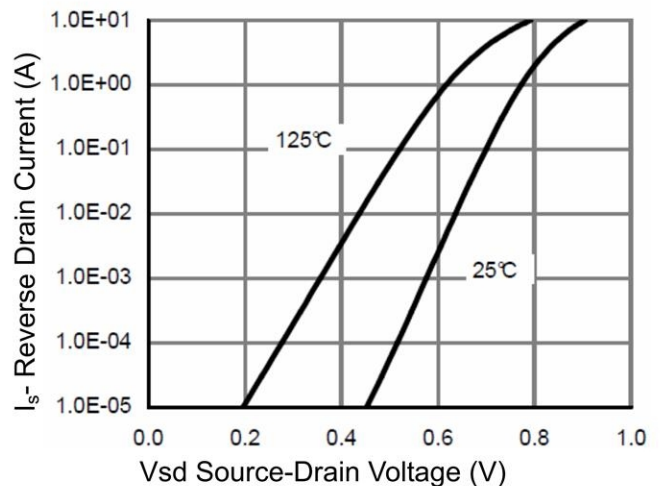

Figure 6 Source- Drain Diode Forward

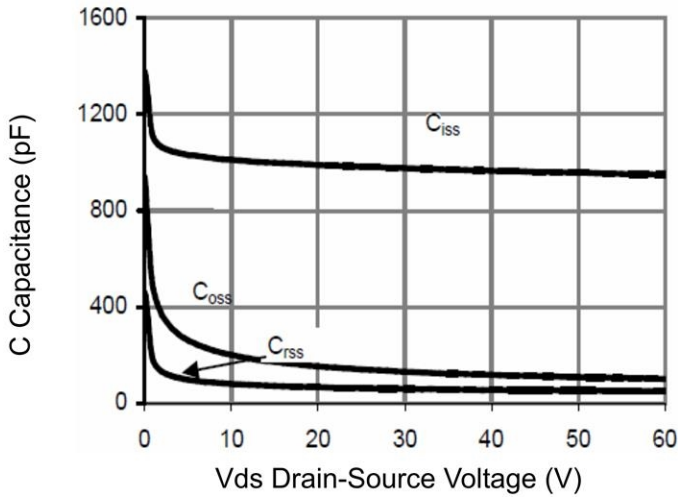

Figure 7 Capacitance vs Vds

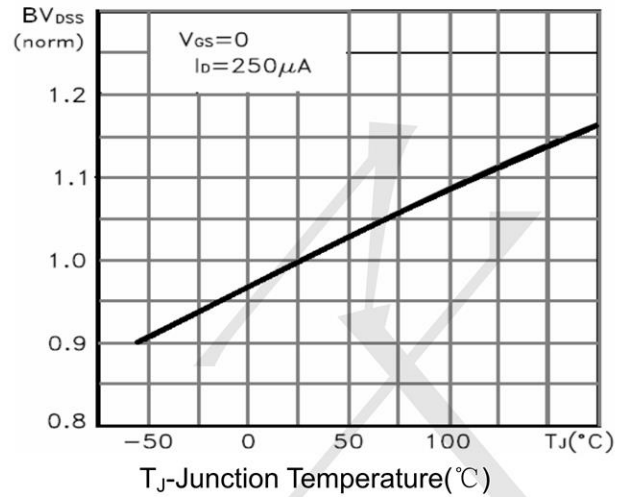

Figure 9 BV_{DSS} vs Junction Temperature

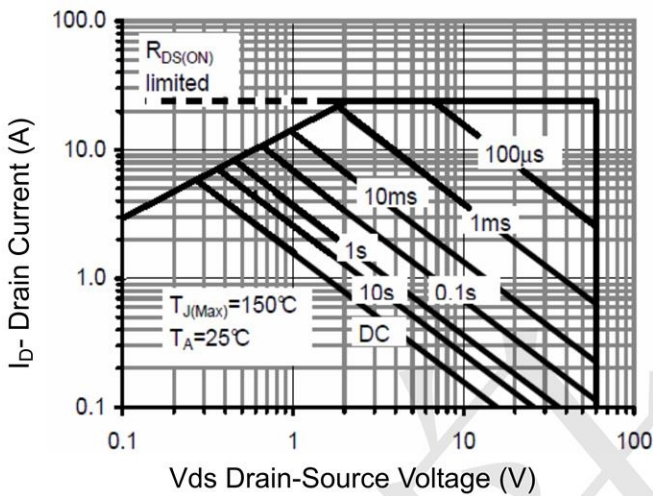

Figure 8 Safe Operation Area

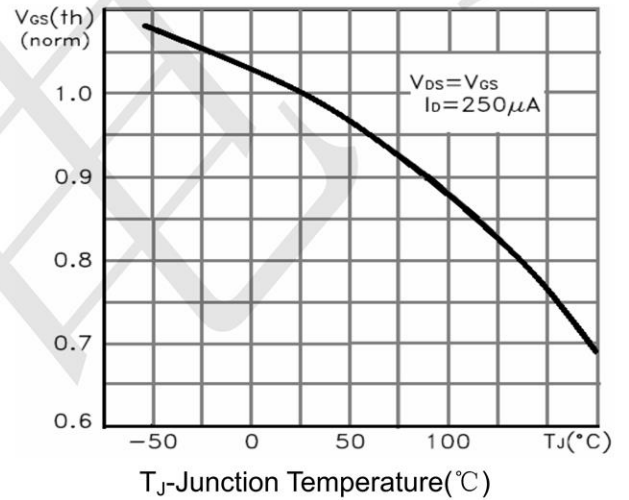

Figure 10 $V_{GS(th)}$ vs Junction Temperature

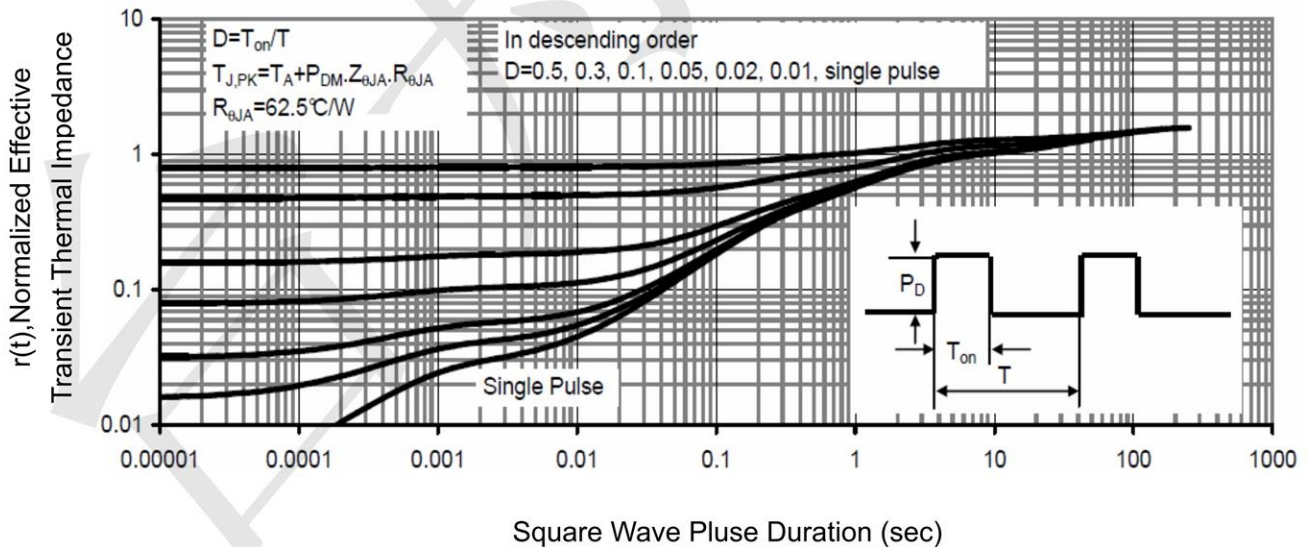
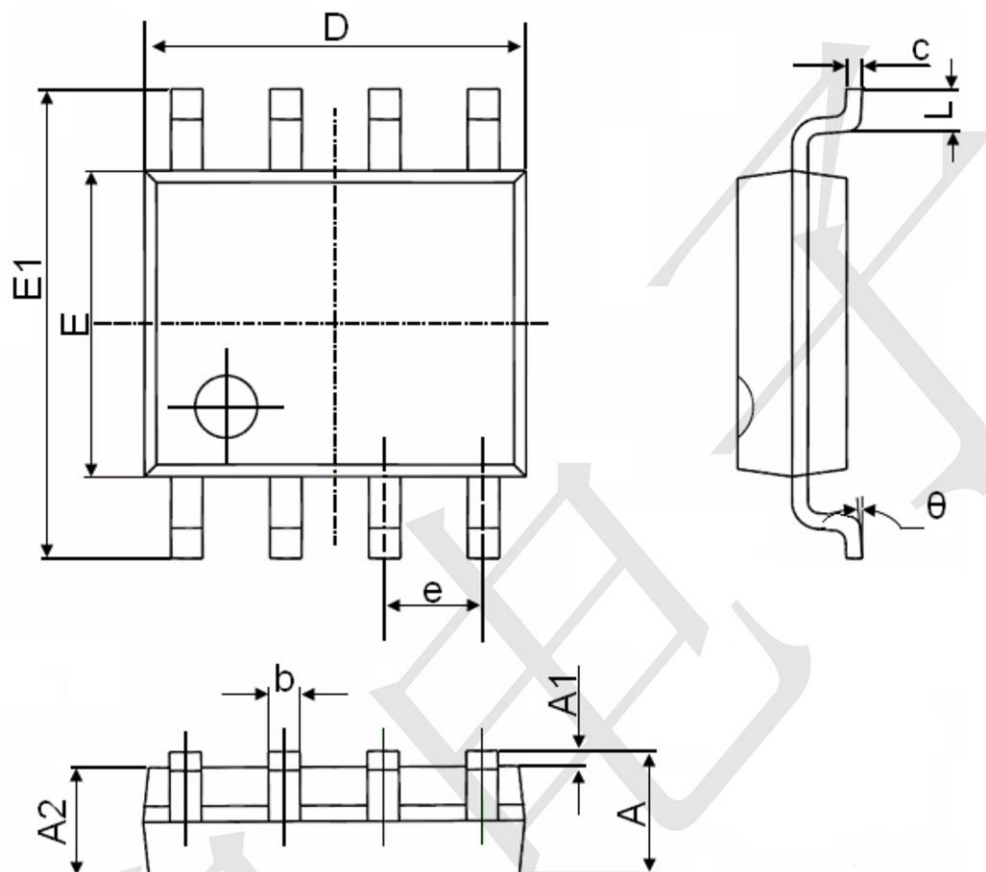

Figure 11 Normalized Maximum Transient Thermal Impedance

SOP-8 Package Information



| Symbol | Dimensions In Millimeters | | Dimensions In Inches | |
|----------|---------------------------|-------|----------------------|-------|
| | Min. | Max. | Min. | Max. |
| A | 1.350 | 1.750 | 0.053 | 0.069 |
| A1 | 0.100 | 0.250 | 0.004 | 0.010 |
| A2 | 1.350 | 1.550 | 0.053 | 0.061 |
| b | 0.330 | 0.510 | 0.013 | 0.020 |
| c | 0.170 | 0.250 | 0.006 | 0.010 |
| D | 4.700 | 5.100 | 0.185 | 0.200 |
| E | 3.800 | 4.000 | 0.150 | 0.157 |
| E1 | 5.800 | 6.200 | 0.228 | 0.244 |
| e | 1.270(BSC) | | 0.050(BSC) | |
| L | 0.400 | 1.270 | 0.016 | 0.050 |
| θ | 0° | 8° | 0° | 8° |

X-ON Electronics

Largest Supplier of Electrical and Electronic Components

Click to view similar products for [MOSFET](#) category:

Click to view products by [TECH PUBLIC](#) manufacturer:

Other Similar products are found below :

[614233C](#) [648584F](#) [IRFD120](#) [IRFF430](#) [JANTX2N5237](#) [2N7000](#) [FCA20N60_F109](#) [FDZ595PZ](#) [AOD464](#) [2SK2267\(Q\)](#) [2SK2545\(Q,T\)](#)
[405094E](#) [423220D](#) [MIC4420CM-TR](#) [VN1206L](#) [614234A](#) [715780A](#) [SSM6J414TU,LF\(T](#) [751625C](#) [PSMN4R2-30MLD](#)
[TK31J60W5,S1VQ\(O](#) [2SK2614\(TE16L1,Q\)](#) [DMN1017UCP3-7](#) [EFC2J004NUZTDG](#) [FCAB21350L1](#) [P85W28HP2F-7071](#) [DMN1053UCP4-7](#)
[NTE2384](#) [NTE2969](#) [NTE6400A](#) [DMN2080UCB4-7](#) [DMN61D9UWQ-13](#) [US6M2GTR](#) [DMN31D5UDJ-7](#) [SSM6P54TU,LF](#) [DMP22D4UFO-](#)
[7B](#) [IPS60R3K4CEAKMA1](#) [DMN1006UCA6-7](#) [DMN16M9UCA6-7](#) [STF5N65M6](#) [STU5N65M6](#) [C3M0021120D](#) [DMN13M9UCA6-7](#)
[BSS340NWH6327XTSA1](#) [MCM3400A-TP](#) [DMTH10H4M6SPS-13](#) [IRF40SC240ARMA1](#) [IPS60R1K0PFD7SAKMA1](#)
[IPS60R360PFD7SAKMA1](#) [IPS60R600PFD7SAKMA1](#)