

### GENERAL FEATURES

- $V_{DS} = 200V$
- $I_D = 1.0 A$  @  $V_{GS} = 10V$
- $R_{DS(ON)} \leq 1.35\Omega$  @  $V_{GS} = 10V$
- SOT-223 package.

### Application

- Power Supply
- PFC
- LED TV

### Package and Pin Configuration

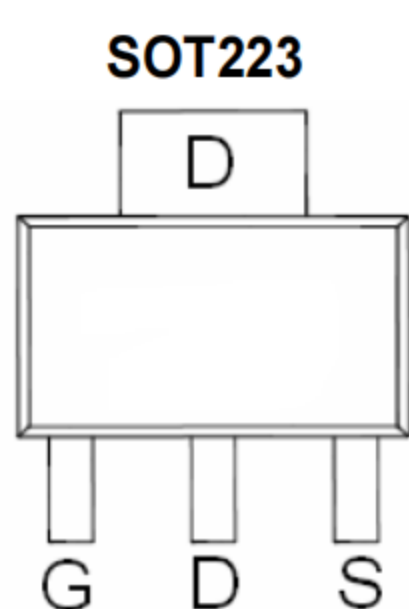

### Circuit diagram

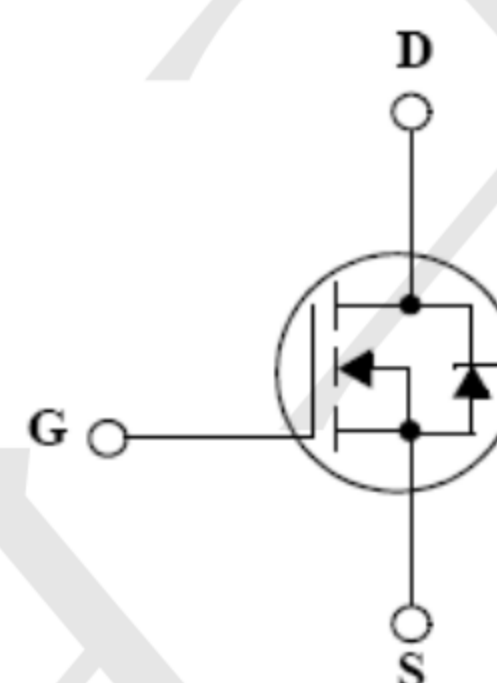

### Marking:

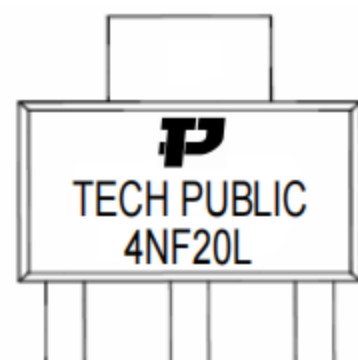

### ABSOLUTE MAXIMUM RATINGS $T_A = 25^\circ C$ unless otherwise noted

Characteristics	Symbol	Rating	Unit
Drain-Source Voltage	$V_{DSS}$	200	V
Gate-Source Voltage	$V_{GSS}$	$\pm 20$	V
Continuous Drain Current	$I_D$	$T_C = 25^\circ C$	1.0
		$T_C = 100^\circ C$	0.54
Pulsed Drain Current <sup>(1)</sup>	$I_{DM}$	3.4	A
Power Dissipation	$P_D$	$T_C = 25^\circ C$	2.1
		Derate above $25^\circ C$	0.017
Peak Diode Recovery $dv/dt$ <sup>(3)</sup>	$Dv/dt$	5.5	V/ns
Repetitive Pulse Avalanche Energy <sup>(4)</sup>	$E_{AR}$	0.21	mJ
Avalanche current <sup>(1)</sup>	$I_{AR}$	0.85	A
Single Pulse Avalanche Energy <sup>(4)</sup>	$E_{AS}$	52	mJ
Junction and Storage Temperature Range	$T_J, T_{stg}$	-55~150	$^\circ C$

### Thermal Characteristics

Characteristics	Symbol	Rating	Unit
Thermal Resistance, Junction-to-Ambient *	$R_{\theta JA}$	60	$^\circ C/W$

### Electrical Characteristics $T_A = 25^\circ\text{C}$ unless otherwise noted

Characteristics	Symbol	Test Condition	Min	Typ	Max	Unit
<b>Static Characteristics</b>						
Drain-Source Breakdown Voltage	$BV_{DSS}$	$I_D = 250\mu\text{A}, V_{GS} = 0\text{V}$	200	-	-	V
Gate Threshold Voltage	$V_{GS(th)}$	$V_{DS} = V_{GS}, I_D = 250\mu\text{A}$	1.0	1.6	2.0	
Drain Cut-Off Current	$I_{DSS}$	$V_{DS} = 200\text{V}, V_{GS} = 0\text{V}$	-	-	1	$\mu\text{A}$
Gate Leakage Current	$I_{GSS}$	$V_{GS} = \pm 20\text{V}, V_{DS} = 0\text{V}$	-	-	100	nA
Drain-Source ON Resistance	$R_{DS(ON)}$	$V_{GS} = 10\text{V}, I_D = 0.425\text{A}$	-	0.9	1.35	$\Omega$
Forward Transconductance	$g_{fs}$	$V_{DS} = 30\text{V}, I_D = 0.425\text{A}$	-	1.3	-	S
<b>Dynamic Characteristics</b>						
Total Gate Charge	$Q_g$	$V_{DS} = 160\text{V}, I_D = 3.8\text{A}, V_{GS} = 5\text{V}$	-	3.2	-	nC
Gate-Source Charge	$Q_{gs}$		-	0.64	-	
Gate-Drain Charge	$Q_{gd}$		-	1.6	-	
Input Capacitance	$C_{iss}$	$V_{DS} = 25\text{V}, V_{GS} = 0\text{V}, f = 1.0\text{MHz}$	-	148	-	pF
Reverse Transfer Capacitance	$C_{rss}$		-	11.3	-	
Output Capacitance	$C_{oss}$		-	42.7	-	
Turn-On Delay Time	$t_{d(on)}$	$V_{GS} = 5\text{V}, V_{DS} = 100\text{V}, I_D = 3.8\text{A}, R_G = 25\Omega$	-	6	-	ns
Rise Time	$t_r$		-	38	-	
Turn-Off Delay Time	$t_{d(off)}$		-	11	-	
Fall Time	$t_f$		-	13	-	
<b>Drain-Source Body Diode Characteristics</b>						
Maximum Continuous Drain to Source Diode Forward Current	$I_S$		-	1.0	-	A
Source-Drain Diode Forward Voltage	$V_{SD}$	$I_S = 0.85\text{A}, V_{GS} = 0\text{V}$	-	-	1.5	V
Body Diode Reverse Recovery Time	$t_{rr}$	$I_F = 3.8\text{A}, di/dt = 100\text{A}/\mu\text{s}^{(3)}$	-	90	-	ns
Body Diode Reverse Recovery Charge	$Q_{rr}$		-	0.24	-	$\mu\text{C}$

### Typical Electrical and Thermal Characteristics

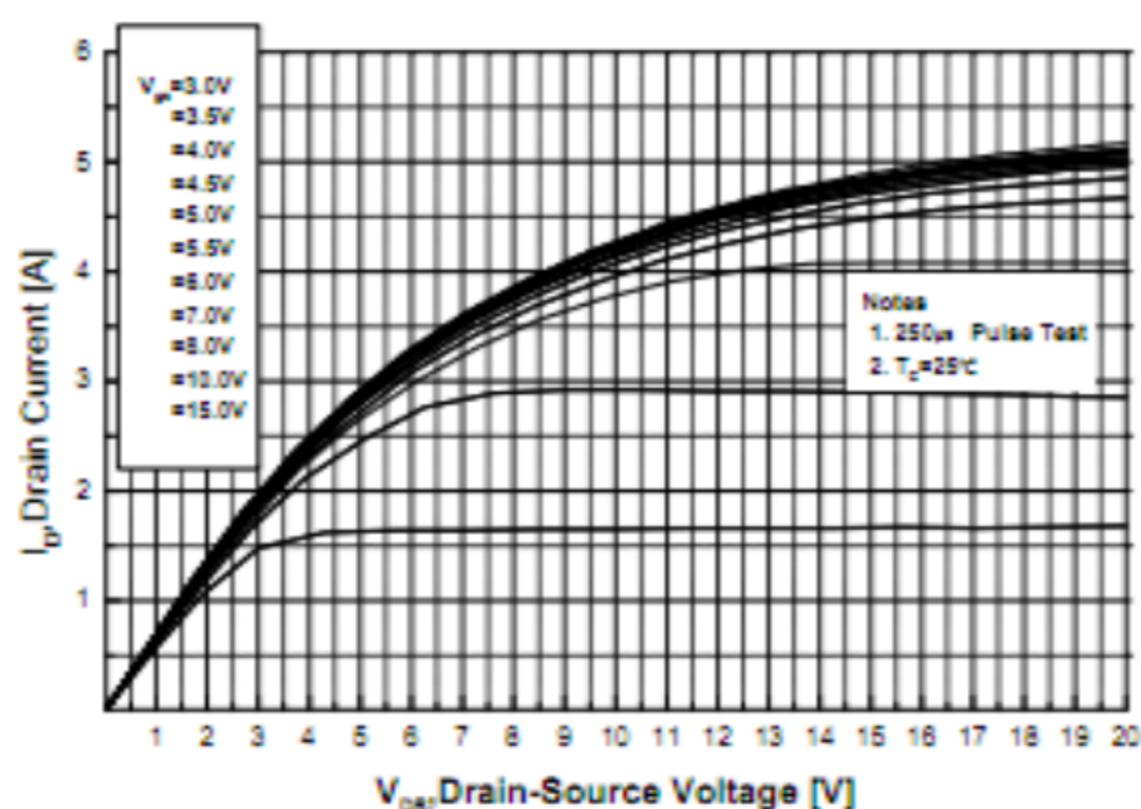

**Fig.1 On-Region Characteristics**

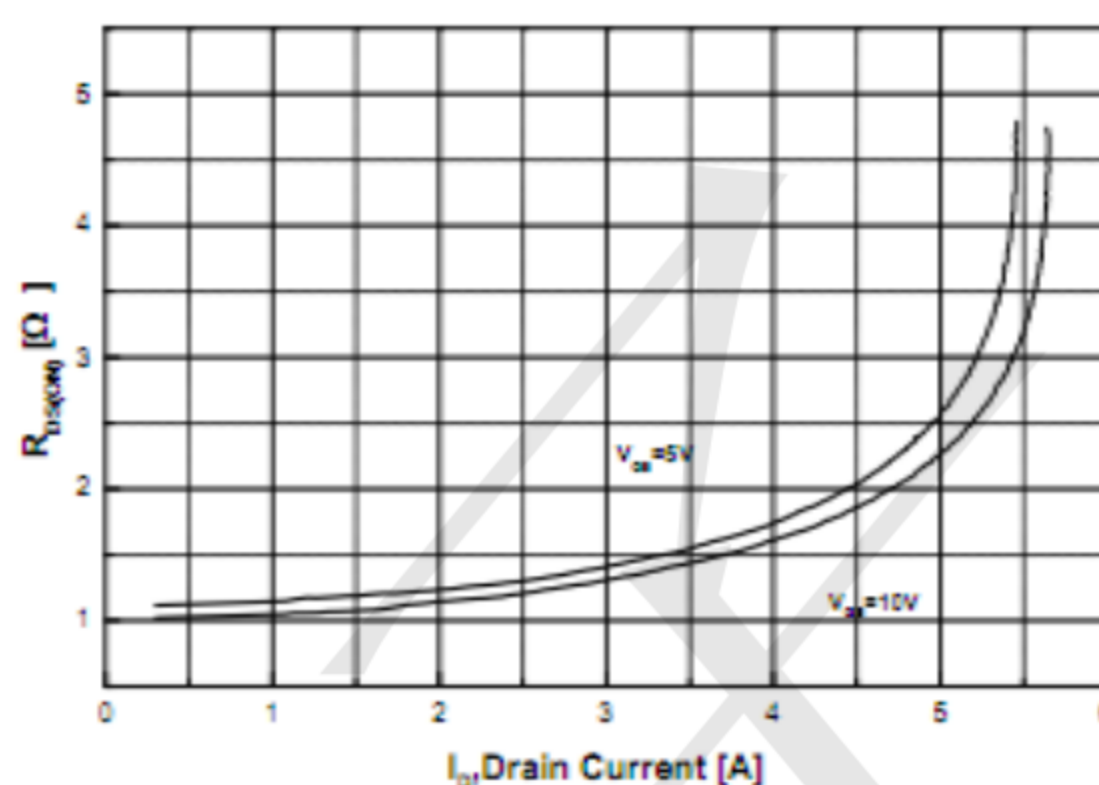

**Fig.2 On-Resistance Variation with Drain Current and Gate Voltage**

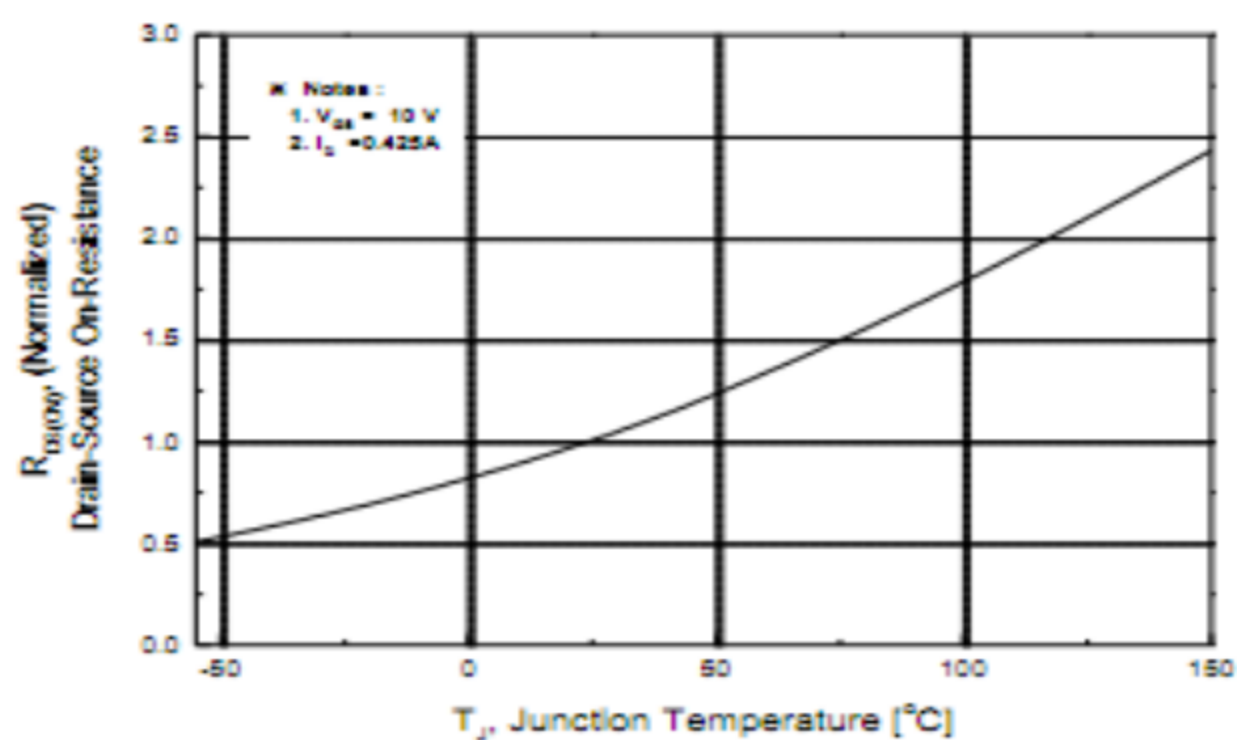

**Fig.3 On-Resistance Variation with Temperature**

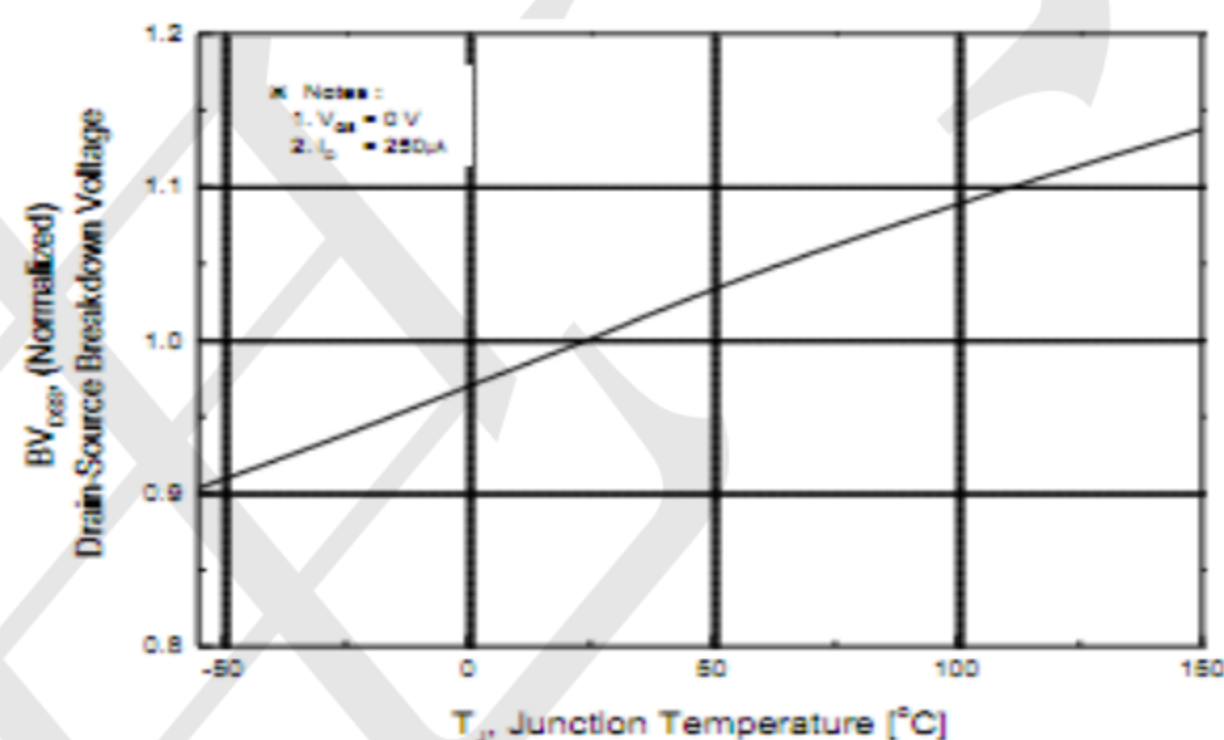

**Fig.4 Breakdown Voltage Variation vs. Temperature**

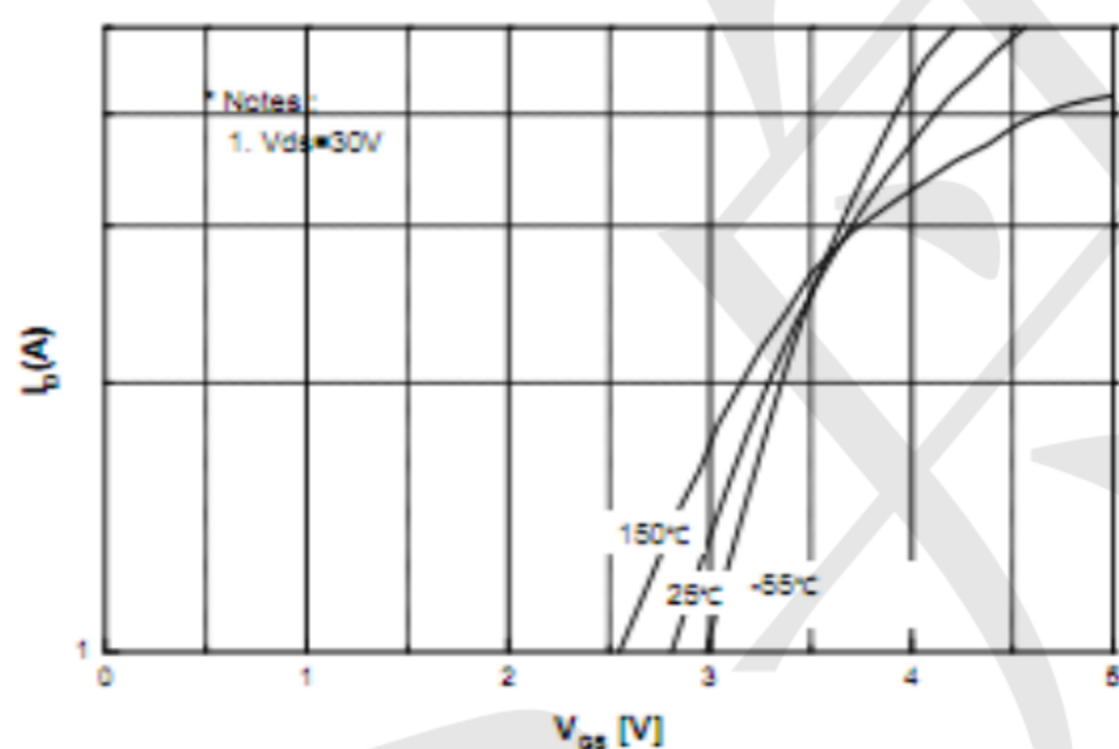

**Fig.5 Transfer Characteristics**

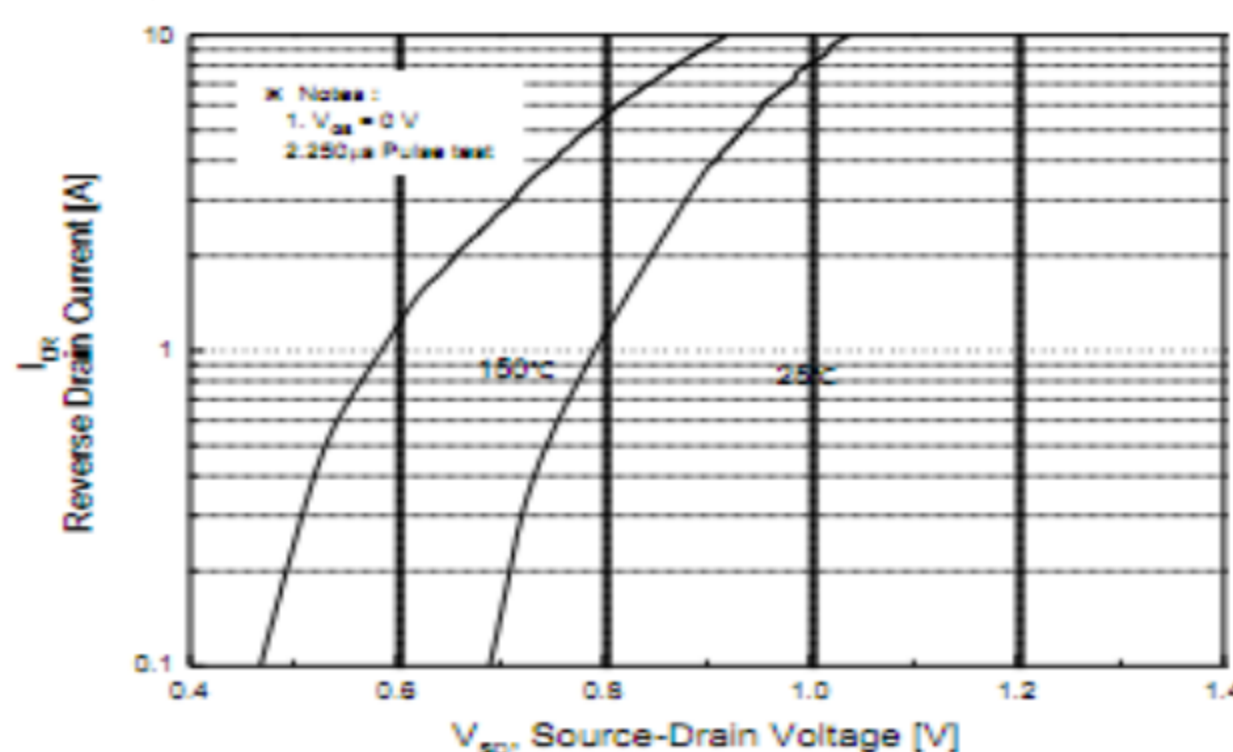

**Fig.6 Body Diode Forward Voltage Variation with Source Current and Temperature**

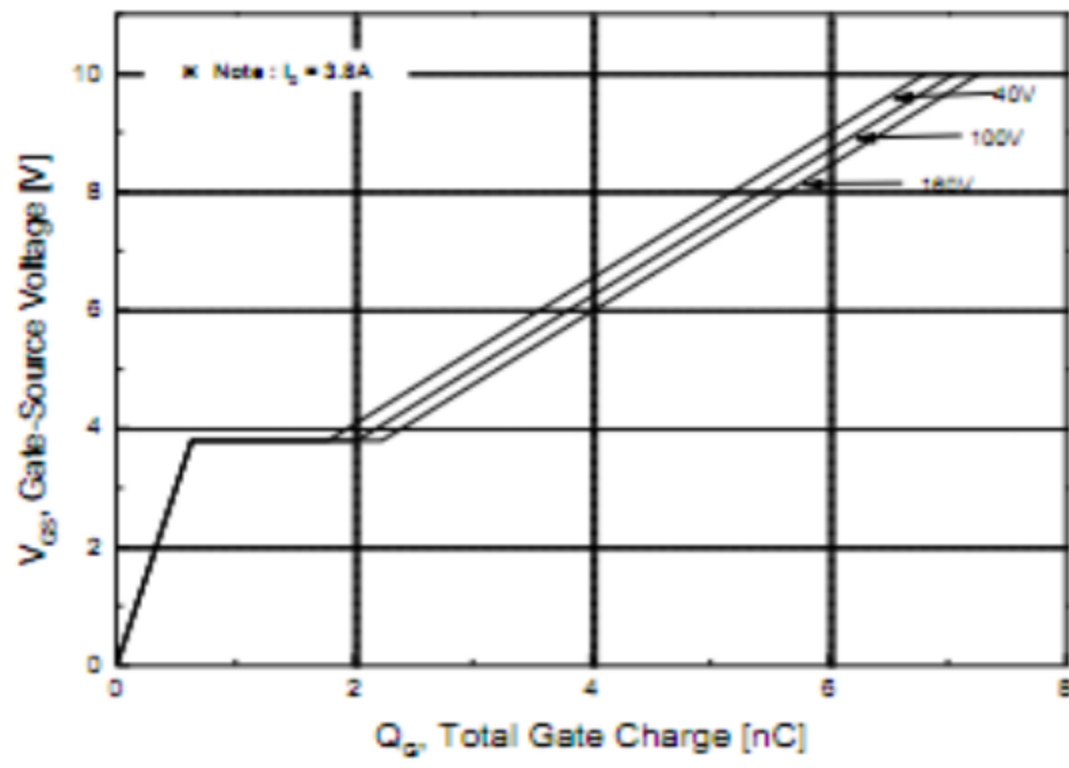

Fig.7 Gate Charge Characteristics

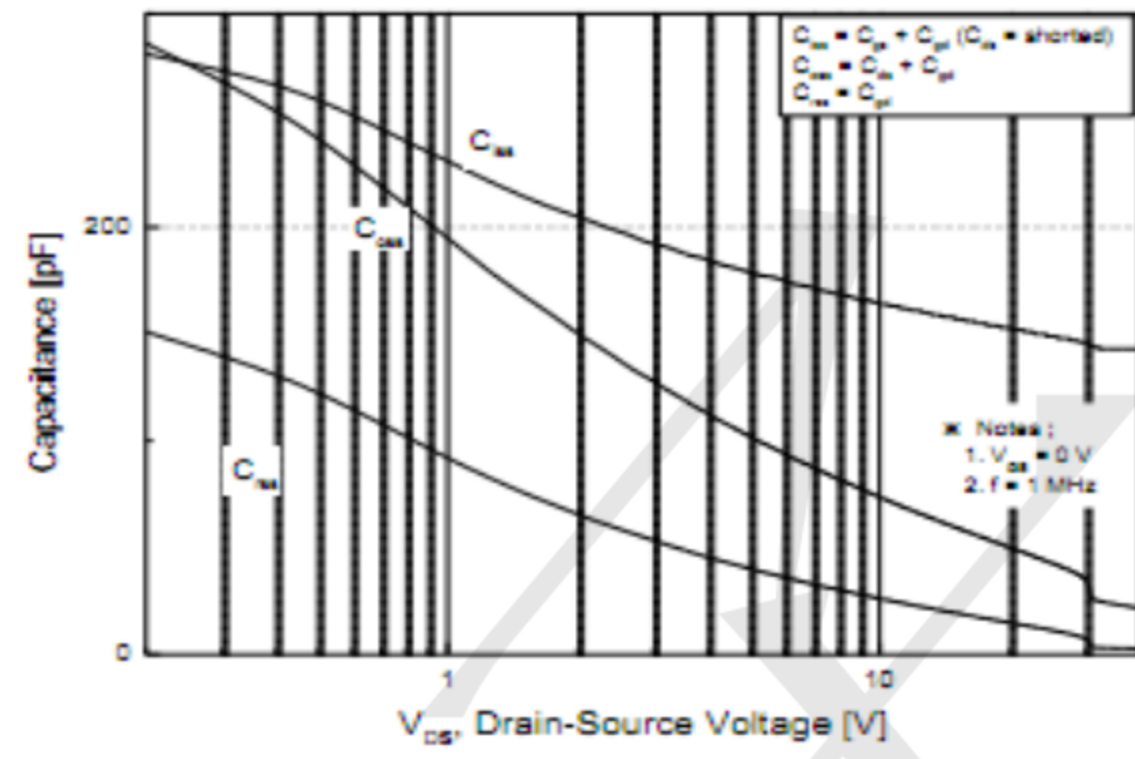

Fig.8 Capacitance Characteristics

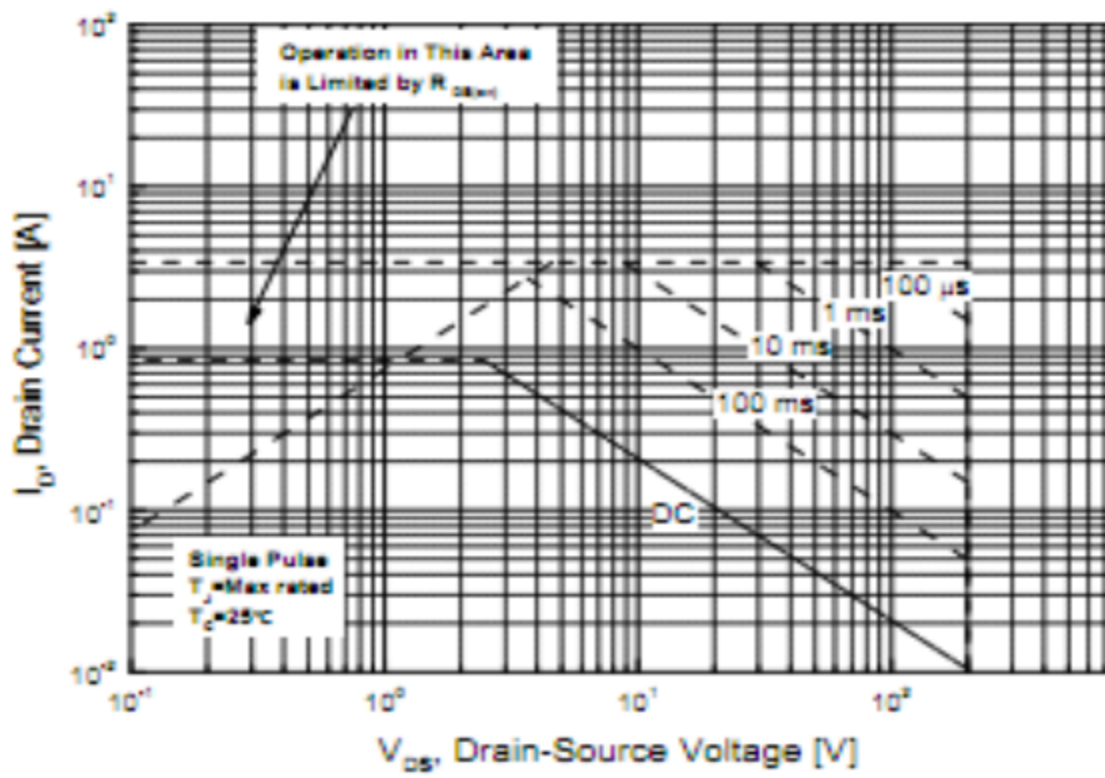

Fig.9 Maximum Safe Operating Area

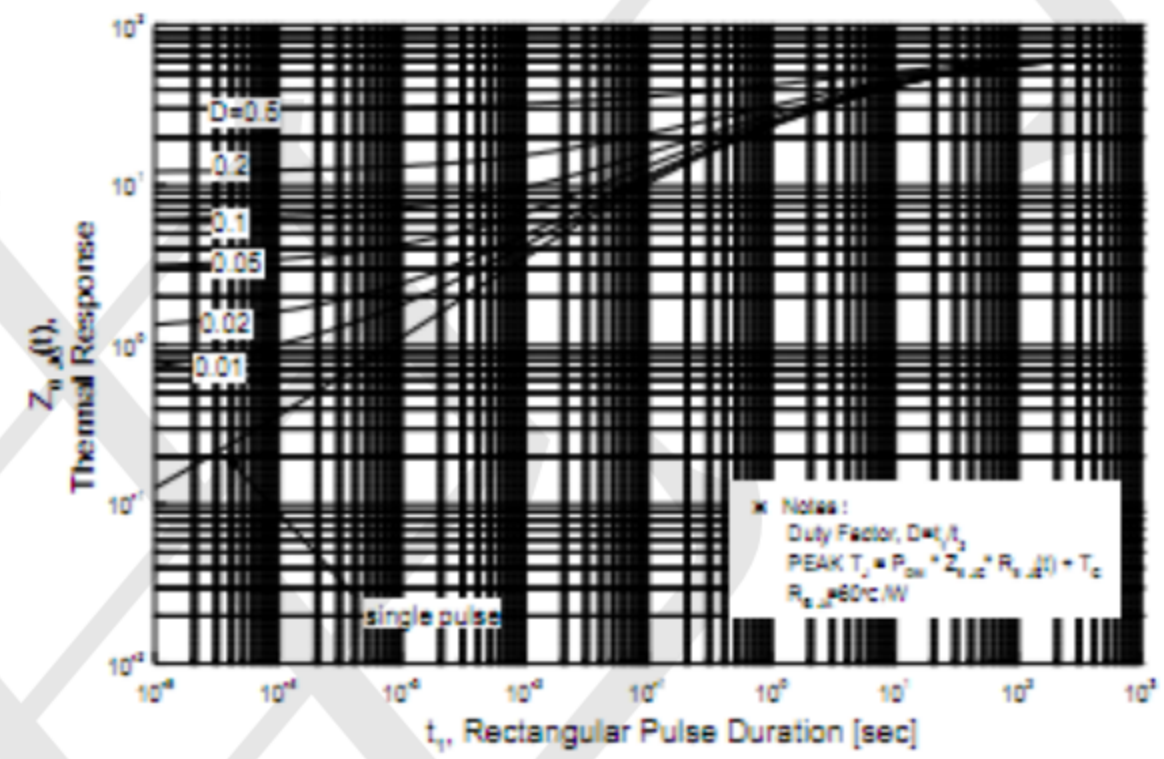

Fig.10 Transient Thermal Response Curve

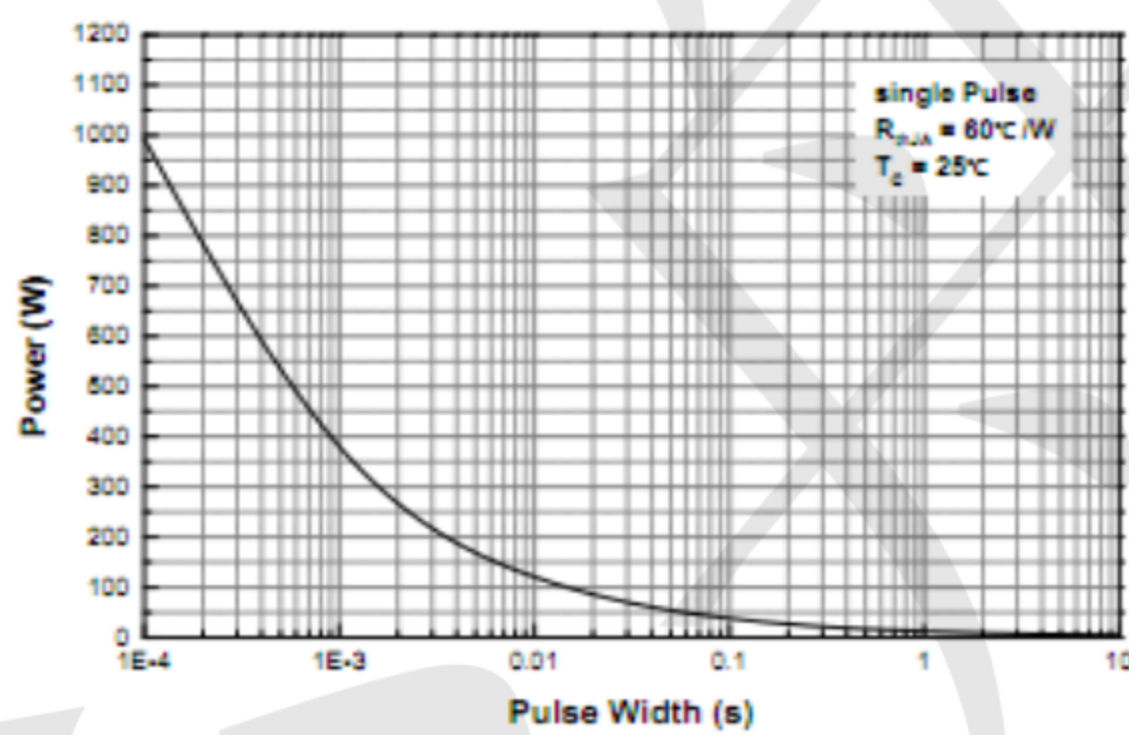

Fig.11 Single Pulse Maximum Power Dissipation

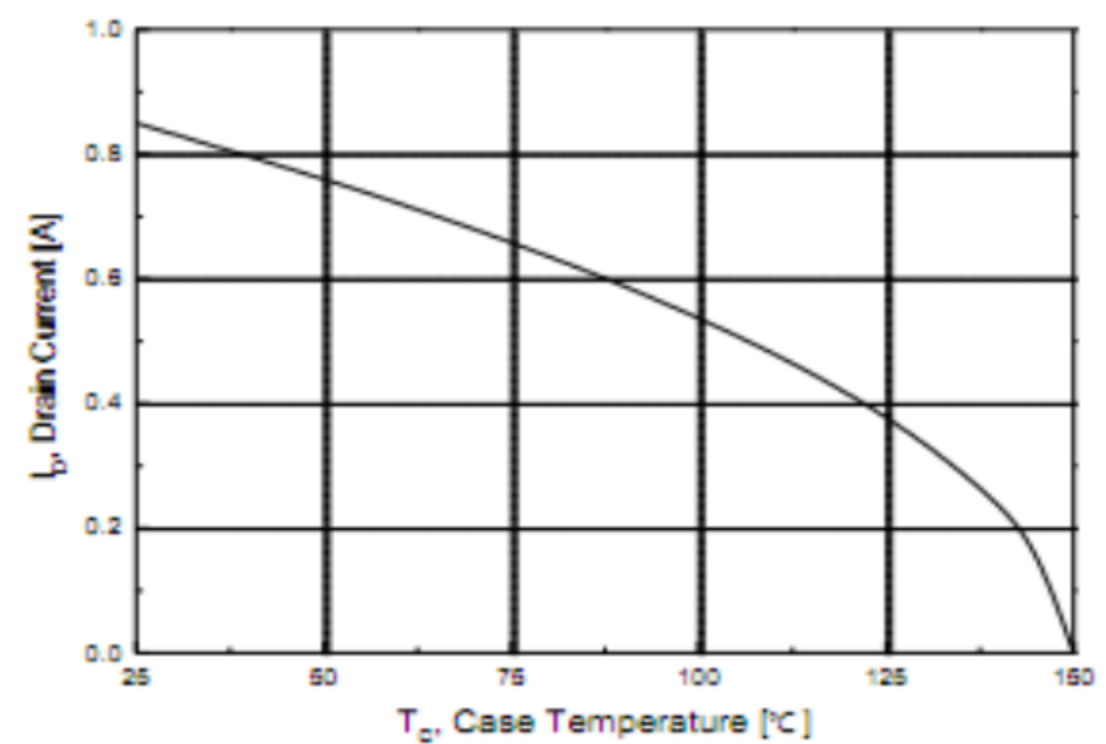
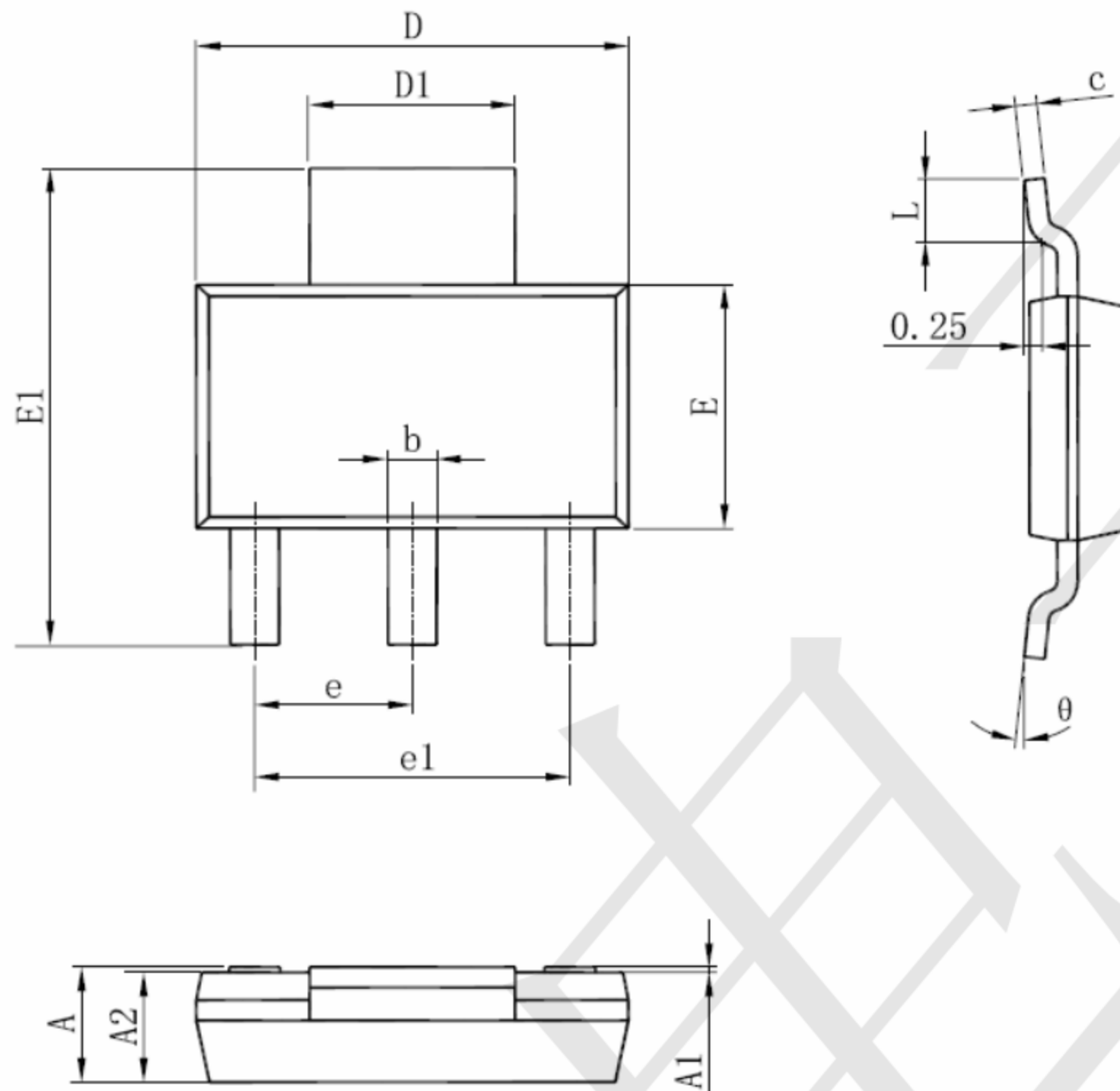

Fig.12 Maximum Drain Current vs. Case Temperature



**SOT-223 Package Information**



Symbol	Dimensions In Millimeters		Dimensions In Inches	
	Min	Max	Min	Max
A	1.520	1.800	0.060	0.071
A1	0.000	0.100	0.000	0.004
A2	1.500	1.700	0.059	0.067
b	0.660	0.820	0.026	0.032
c	0.250	0.350	0.010	0.014
D	6.200	6.400	0.244	0.252
D1	2.900	3.100	0.114	0.122
E	3.300	3.700	0.130	0.146
E1	6.830	7.070	0.269	0.278
e	2.300(BSC)		0.091(BSC)	
e1	4.500	4.700	0.177	0.185
L	0.900	1.150	0.035	0.045
θ	0°	10°	0°	10°

## X-ON Electronics

Largest Supplier of Electrical and Electronic Components

*Click to view similar products for [MOSFET](#) category:*

*Click to view products by [TECH PUBLIC](#) manufacturer:*

Other Similar products are found below :

[IRFD120](#) [JANTX2N5237](#) [2SK2267\(Q\)](#) [BUK455-60A/B](#) [TK100A10N1,S4X\(S](#) [MIC4420CM-TR](#) [VN1206L](#) [NDP4060](#) [SI4482DY](#)  
[IRS2092STRPBF-EL](#) [IPS70R2K0CEAKMA1](#) [TK31J60W5,S1VQ\(O](#) [TK31J60W,S1VQ\(O](#) [TK16J60W,S1VQ\(O](#) [2SK2614\(TE16L1,Q\)](#)  
[DMN1017UCP3-7](#) [EFC2J004NUZTDG](#) [P85W28HP2F-7071](#) [DMN1053UCP4-7](#) [NTE2384](#) [DMC2700UDMQ-7](#) [DMN2080UCB4-7](#)  
[DMN61D9UWQ-13](#) [US6M2GTR](#) [DMN31D5UDJ-7](#) [DMP22D4UFO-7B](#) [IPS60R3K4CEAKMA1](#) [DMN1006UCA6-7](#) [DMN16M9UCA6-7](#)  
[STF5N65M6](#) [IRF40H233XTMA1](#) [STU5N65M6](#) [DMN6022SSD-13](#) [DMN13M9UCA6-7](#) [DMTH10H4M6SPS-13](#) [IPS60R360PFD7SAKMA1](#)  
[DMN2990UFB-7B](#) [SSM3K35CT,L3F](#) [IPLK60R1K0PFD7ATMA1](#) [2N7002W-G](#) [MCAC30N06Y-TP](#) [IPWS65R035CFD7AXKSA1](#)  
[MCQ7328-TP](#) [SSM3J143TU,LXHF](#) [DMN12M3UCA6-7](#) [PJMF280N65E1\\_T0\\_00201](#) [PJMF380N65E1\\_T0\\_00201](#)  
[PJMF280N60E1\\_T0\\_00201](#) [PJMF600N65E1\\_T0\\_00201](#) [PJMF900N65E1\\_T0\\_00201](#)