

### Features

- ◆ Transient protection for data lines to **IEC 61000-4-2 (ESD) ±20kV (air), ±20kV (contact)**  
**IEC 61000-4-4 (EFT) 40A (tp = 5/50ns)**  
**Cable Discharge Event (CDE)**
- ◆ Protects one data or I/O line
- ◆ Low capacitance: **0.3pF**
- ◆ Low clamping voltage
- ◆ Low operating voltage: 5.0V
- ◆ Solid-state silicon-avalanche technology

### Mechanical Characteristics

- ◆ Package: SOD-323
- ◆ Lead Finish: Matte Tin
- ◆ UL Flammability Classification Rating 94V-0
- ◆ Pb-Free, Halogen Free, RoHS/WEEE Compliant



### Applications

- ◆ Cellular Handsets & Accessories
- ◆ Digital Visual Interface (DVI)
- ◆ Display Port
- ◆ MDDI Ports
- ◆ USB Ports
- ◆ PCI Express
- ◆ Serial ATA

### Ordering Information

Part Number	Qty per Reel	Reel Size
GBLC05CTP	3000	7"

### Dimensions and Pin Configuration

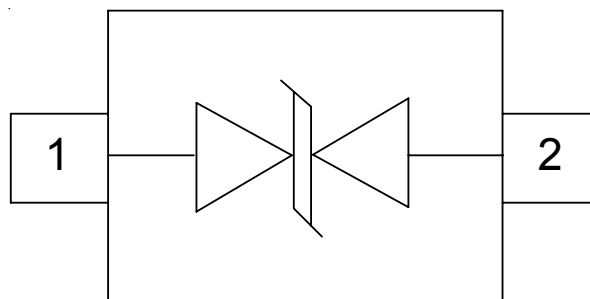

**Absolute Maximum Ratings ( $T_A=25^\circ\text{C}$  unless otherwise specified)**

Parameter	Symbol	Limits	unit
IEC61000-4-2(ESD) Air Contact	$V_{\text{ESD}}$	$\pm 20$ $\pm 20$	KV
Peak Pulse Power (8/20us)	$P_{\text{pk}}$	120	W
Peak Pulse Current (8/20us)	$I_{\text{pp}}$	4	A

**Electrical Characteristics ( $T_A=25^\circ\text{C}$  unless otherwise specified)**

Symbol	Parameter
$V_{\text{RWM}}$	Nominal Reverse Working Voltage
$I_{\text{R}}$	Reverse Leakage Current @ $V_{\text{RWM}}$
$V_{\text{BR}}$	Reverse Breakdown Voltage @ $I_{\text{T}}$
$I_{\text{T}}$	Test Current for Reverse Breakdown
$V_{\text{C}}$	Clamping Voltage @ $I_{\text{PP}}$
$I_{\text{PP}}$	Maximum Peak Pulse Current
$C_{\text{ESD}}$	Parasitic Capacitance
$V_{\text{R}}$	Reverse Voltage
f	Small Signal Frequency

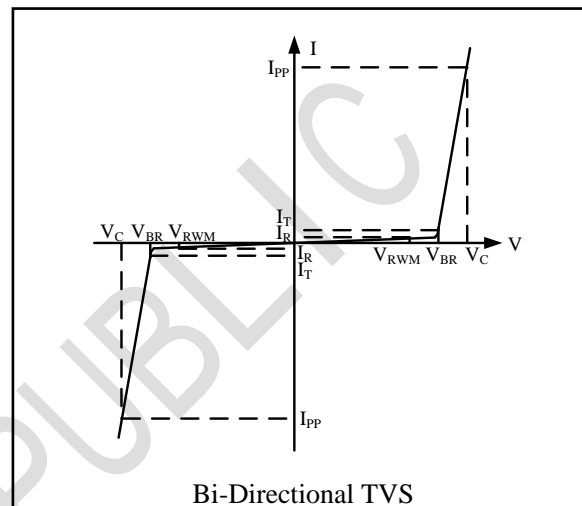

Parameter	Symbol	Min	Typ	Max	Unit	Test Condition
Reverse Working Voltage	$V_{\text{RWM}}$			5	V	
Breakdown Voltage	$V_{\text{BR}}$	6			V	$I_{\text{T}} = 1\text{mA}$
Reverse Leakage Current	$I_{\text{R}}$			1	$\mu\text{A}$	$V_{\text{RWM}} = 3.3\text{V}$
Clamping Voltage	$V_{\text{C}}$			10	V	$I_{\text{PP}} = 1\text{A}$ (8 x 20 $\mu\text{s}$ pulse)
Clamping Voltage	$V_{\text{C}}$			25	V	$I_{\text{PP}} = 4\text{A}$ (8 x 20 $\mu\text{s}$ pulse)
Junction Capacitance	$C_{\text{J}}$		0.3	0.5	pF	$V_{\text{R}} = 0\text{V}$ , $f = 1\text{MHz}$

**PROTECTION PRODUCTS**  
Typical characteristics

**Fig1. 8/20 $\mu$ s Pulse Waveform**

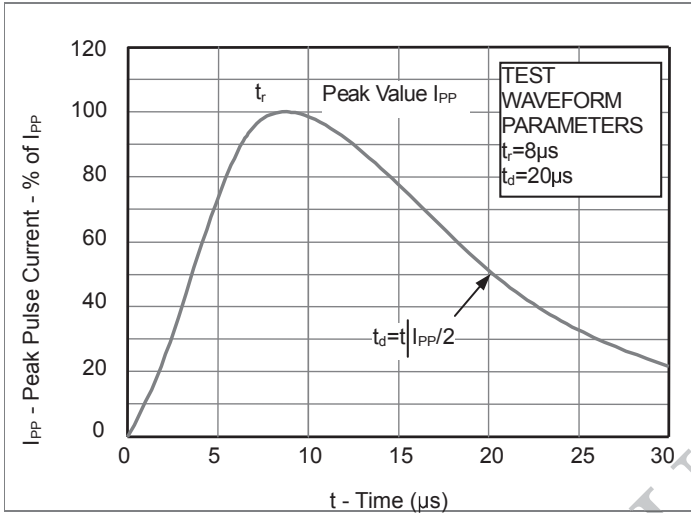

**Fig2. ESD Pulse Waveform (according to IEC 61000-4-2)**

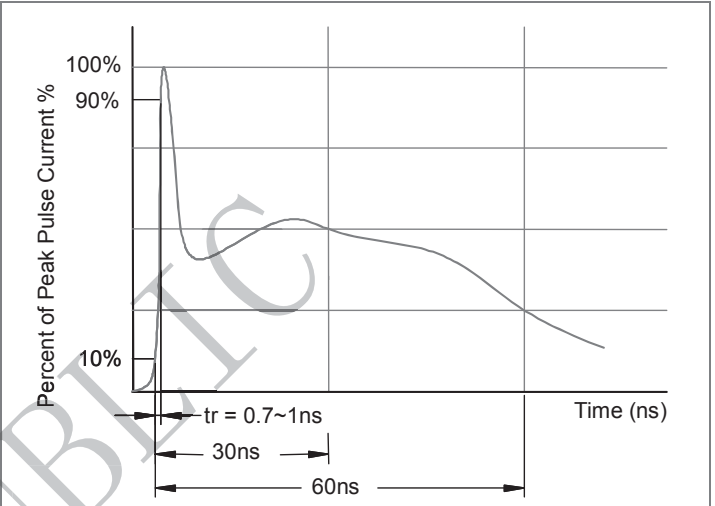

**Fig3. Power Derating Curve**

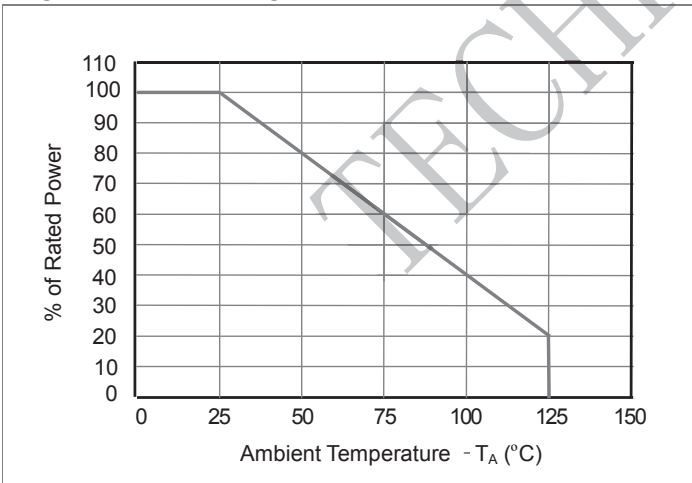

**Outline Drawing - SOD-323**

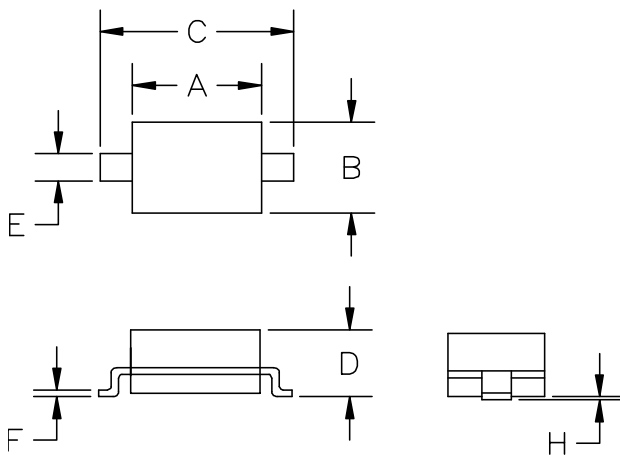

SYM	DIMENSIONS			
	MILLIMETERS		INCHES	
	MIN	MAX	MIN	MAX
A	1.50	1.80	0.060	0.071
B	1.20	1.40	0.045	0.054
C	2.30	2.70	0.090	0.107
D	-	1.10	-	0.043
E	0.30	0.40	0.012	0.016
F	0.10	0.25	0.004	0.010
H	-	0.10	-	0.004

**Land Pattern - SOD-323**

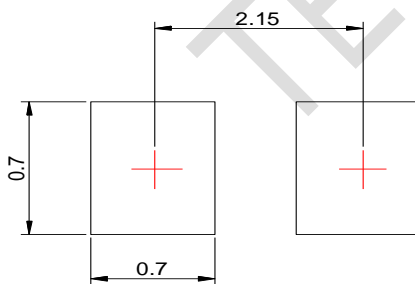

## X-ON Electronics

Largest Supplier of Electrical and Electronic Components

*Click to view similar products for [ESD Suppressors / TVS Diodes](#) category:*

*Click to view products by [TECH PUBLIC](#) manufacturer:*

Other Similar products are found below :

[NTE4902](#) [P4SMAJ15A](#) [P4SMAJ26A](#) [SMAJ400CA-TP](#) [TGL34-47CA](#) [ESDAULC45-1BF4](#) [SM1605E3/TR13](#) [SMF20A-TP](#) [P4SMAJ12A](#)  
[CPDUR24V-HF](#) [CPDQC5V0USP-HF](#) [CPDQC5V0-HF](#) [MPLAD30KP45CAE3](#) [MMBZ27VCLQ-7-F](#) [MMAD1108/TR13](#) [MPLAD30KP24A](#)  
[ACPDQC5V0R-HF](#) [DFLT170A-7](#) [NTE4900](#) [NTE4926](#) [NTE4938](#) [SMF22A-TP](#) [SMF12A-TP](#) [SLVU2.8-TP](#) [SMLJ6.5CA-TP](#) [SMAJ6.5CA-](#)  
[TP](#) [MMAD1108E3/TR13](#) [D5V0M1U2LP3-7](#) [SMAJ400A-TP](#) [AOZ8811DT-03](#) [AOZ8831DI-05](#) [AOZ8831DT-03](#) [SMAJ188CA](#) [3SMC33CA](#)  
[BK](#) [CPDQC3V3C-HF](#) [CPDQC12VE-HF](#) [MPLAD30KP170CA](#) [82357120100](#) [5.0SMLJ15CA-TP](#) [5KP18A-TP](#) [P6KE8.2A-TP](#)  
[MPLAD30KP43CAE3](#) [SMAJ43A-TP](#) [D5V0F6U8LP33-7](#) [TVS5501V10MUT5G](#) [5.0SMLJ24CA-TP](#) [SMAJ110CA-TP](#) [MPLAD15KP75CAE3](#)  
[MMAD1103e3/TR13](#) [DFLT40AQ-7](#)