

### GENERAL FEATURES

KEY PERFORMANCE PARAMETERS			
PARAMETER	VALUE	UNIT	
$V_{DS}$	100	V	
$R_{DS(on)}$ (max)	$V_{GS} = 10V$	100	mΩ
	$V_{GS} = 4.5V$	118	
$Q_g$	9.3	nC	

### Application

- Load/Power Switching
- Interfacing Switching
- Logic Level Shift

### Package and Pin Configuration

SOT223

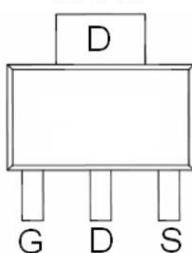

### Circuit diagram

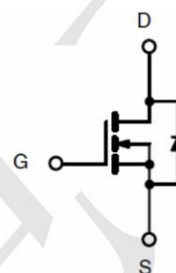

### Marking:

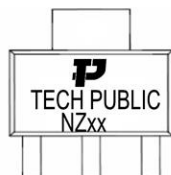

“P” is part number, fixed  
 “NZ” is part number, fixed  
 “xx” is internal code

### Absolute Maximum Ratings ( $T_A=25^\circ\text{C}$ unless otherwise noted)

ABSOLUTE MAXIMUM RATINGS ( $T_A = 25^\circ\text{C}$ unless otherwise noted)			
PARAMETER	SYMBOL	LIMIT	UNIT
Drain-Source Voltage	$V_{DS}$	100	V
Gate-Source Voltage	$V_{GS}$	$\pm 20$	V
Continuous Drain Current (Note 1)	$I_D$	$T_C = 25^\circ\text{C}$	6.5
		$T_C = 100^\circ\text{C}$	4.1
Pulsed Drain Current (Note 2)	$I_{DM}$	26	A
Total Power Dissipation @ $T_C = 25^\circ\text{C}$	$P_{DTOT}$	9	W
Operating Junction and Storage Temperature Range	$T_J, T_{STG}$	- 55 to +150	$^\circ\text{C}$

### Thermal Characteristic

PARAMETER	SYMBOL	LIMIT	UNIT
Junction to Case Thermal Resistance	$R_{\theta JC}$	14	$^\circ\text{C/W}$
Junction to Ambient Thermal Resistance	$R_{\theta JA}$	62	$^\circ\text{C/W}$

### Electrical Characteristics ( $T_A=25^\circ\text{C}$ unless otherwise noted)

<b>ELECTRICAL SPECIFICATIONS</b> ( $T_A = 25^\circ\text{C}$ unless otherwise noted)						
PARAMETER	CONDITIONS	SYMBOL	MIN	TYP	MAX	UNIT
<b>Static</b> (Note 3)						
Drain-Source Breakdown Voltage	$V_{GS} = 0\text{V}, I_D = 250\mu\text{A}$	$BV_{DSS}$	100	--	--	V
Gate Threshold Voltage	$V_{DS} = V_{GS}, I_D = 250\mu\text{A}$	$V_{GS(TH)}$	1.2	1.6	2.5	V
Gate Body Leakage	$V_{GS} = \pm 20\text{V}, V_{DS} = 0\text{V}$	$I_{GSS}$	--	--	$\pm 100$	nA
Zero Gate Voltage Drain Current	$V_{DS} = 100\text{V}, V_{GS} = 0\text{V}$	$I_{DSS}$	--	--	1	$\mu\text{A}$
Drain-Source On-State Resistance	$V_{GS} = 10\text{V}, I_D = 5\text{A}$	$R_{DS(on)}$	--	80	100	m $\Omega$
	$V_{GS} = 4.5\text{V}, I_D = 3\text{A}$		--	85	118	
<b>Dynamic</b> (Note 4)						
Total Gate Charge	$V_{DS} = 48\text{V}, I_D = 5\text{A},$ $V_{GS} = 10\text{V}$	$Q_g$	--	9.3	--	nC
Gate-Source Charge		$Q_{gs}$	--	2.1	--	
Gate-Drain Charge		$Q_{gd}$	--	1.8	--	
Input Capacitance	$V_{DS} = 50\text{V}, V_{GS} = 0\text{V},$ $f = 1.0\text{MHz}$	$C_{iss}$	--	1480	--	pF
Output Capacitance		$C_{oss}$	--	480	--	
Reverse Transfer Capacitance		$C_{rss}$	--	35	--	
Gate Resistance	$f = 1\text{MHz}, \text{open drain}$	$R_g$	--	1.3	--	$\Omega$
<b>Switching</b> (Note 5)						
Turn-On Delay Time	$V_{DD} = 30\text{V},$ $R_{GEN} = 3.3\Omega,$ $I_D = 1\text{A}, V_{GS} = 10\text{V},$	$t_{d(on)}$	--	2.9	--	ns
Turn-On Rise Time		$t_r$	--	9.5	--	
Turn-Off Delay Time		$t_{d(off)}$	--	18.4	--	
Turn-Off Fall Time		$t_f$	--	5.3	--	
<b>Source-Drain Diode</b> (Note 3)						
Forward On Voltage	$I_S = 3.3\text{A}, V_{GS} = 0\text{V}$	$V_{SD}$	--	--	1	V
Continuous Drain-Source Diode		$I_S$	--	--	6.5	A
Pulse Drain-Source Diode		$I_{SM}$	--	--	26	A

**Typical Electrical and Thermal Characteristics**

**Continuous Drain Current vs.  $T_c$**

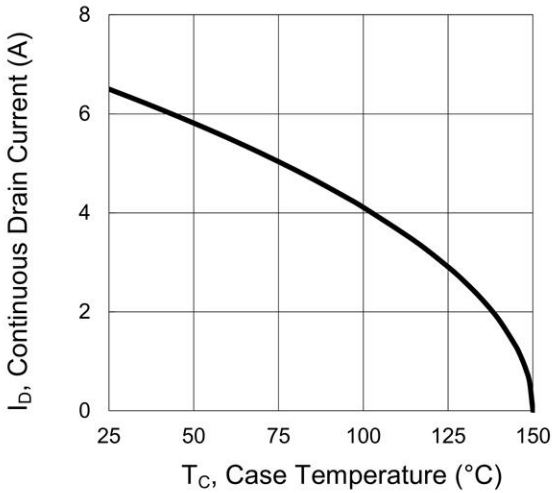

**Gate Charge**

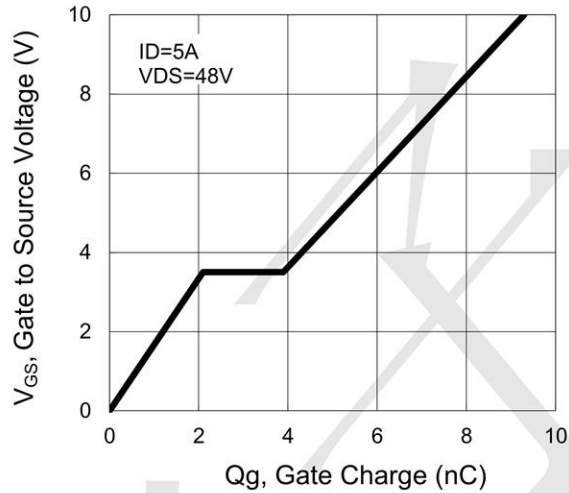

**On-Resistance vs. Junction Temperature**

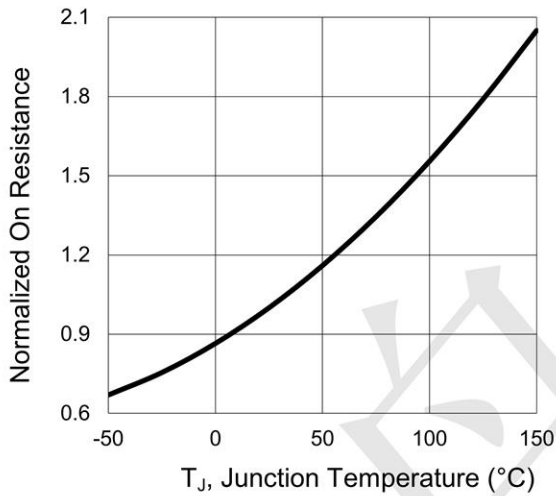

**Threshold Voltage vs. Junction Temperature**

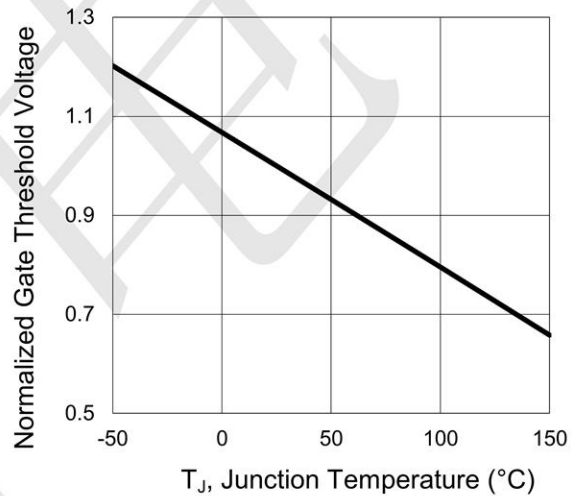

**Maximum Safe Operating Area**

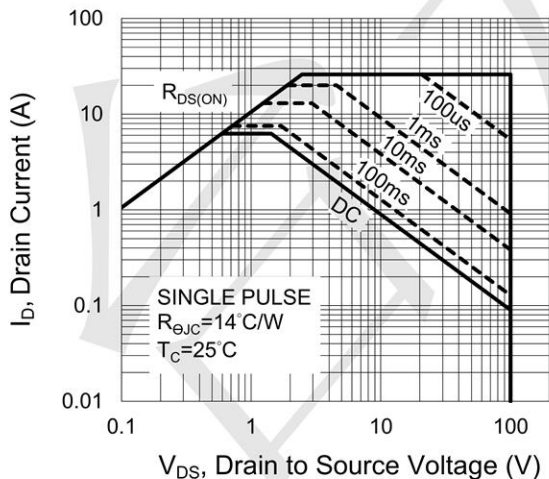

**Normalized Thermal Transient Impedance Curve**

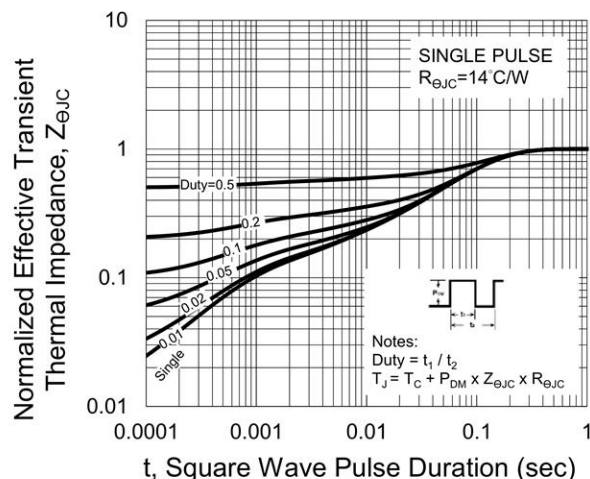

**SOT-223 Package Information**

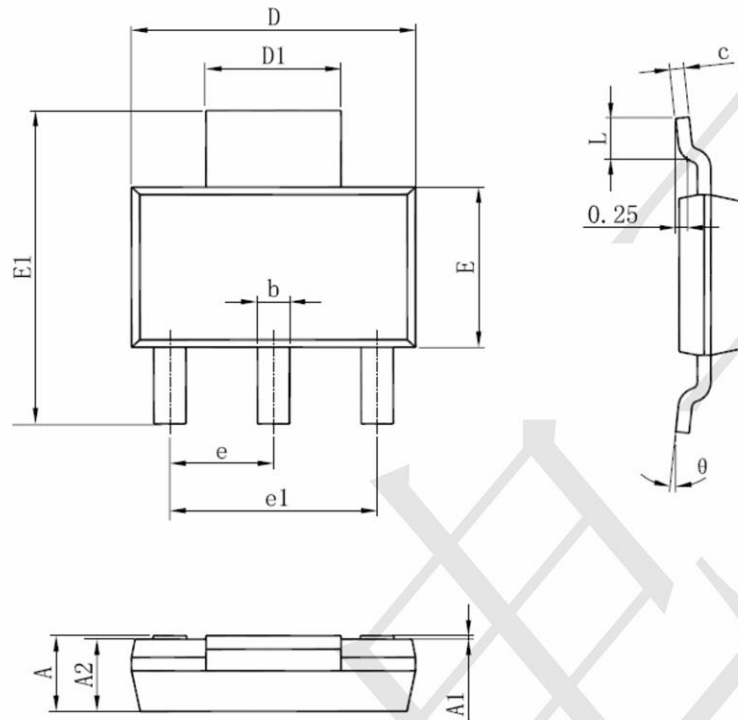

Symbol	Dimensions In Millimeters		Dimensions In Inches	
	Min	Max	Min	Max
A	1.520	1.800	0.060	0.071
A1	0.000	0.100	0.000	0.004
A2	1.500	1.700	0.059	0.067
b	0.660	0.820	0.026	0.032
c	0.250	0.350	0.010	0.014
D	6.200	6.400	0.244	0.252
D1	2.900	3.100	0.114	0.122
E	3.300	3.700	0.130	0.146
E1	6.830	7.070	0.269	0.278
e	2.300(BSC)		0.091(BSC)	
e1	4.500	4.700	0.177	0.185
L	0.900	1.150	0.035	0.045
θ	0°	10°	0°	10°

## X-ON Electronics

Largest Supplier of Electrical and Electronic Components

*Click to view similar products for [RF MOSFET Transistors](#) category:*

*Click to view products by [TECH PUBLIC](#) manufacturer:*

Other Similar products are found below :

[FH2164](#) [BLF245](#) [ARF465BG](#) [BF 2030](#) [E6814](#) [BLF861A](#) [MRF6S20010GNR1](#) [DU28200M](#) [MMRF1015NR1](#) [UF28100M](#) [MW6S010GNR1](#)  
[DU2820S](#) [MRF24301HR5](#) [MMRF1014NT1](#) [MRF422](#) [ARF468BG](#) [MAPHST0045](#) [A2T27S020NR1](#) [DU2860U](#) [MHT1803A](#) [VRF152GMP](#)  
[MRFE6VP5300NR1](#) [BF2040E6814HTSA1](#) [MRFE6VP5150NR1](#) [MMRF5014HR5](#) [LET9060S](#) [MRF136Y](#) [MRF175GV](#) [AFT27S010NT1](#)  
[AFT27S006NT1](#) [MRF1K50NR5](#) [BG 3130](#) [H6327](#) [MRFE6VP5300NR1](#) [MRFE6VP5600HR6](#) [MRFX1K80HR5](#) [BF998E6327HTSA1](#)  
[AFM907NT1](#) [AFT05MS006NT1](#) [AFV10700HR5](#) [MRF141](#) [MRF492](#) [MRF141](#) [MRF171](#) [MRF172](#) [MRF174](#) [AFM906NT1](#) [BLF578XR,112](#)  
[TPM9305PD6](#) [CJU02N65](#) [FDS9926A](#) [AFT05MS031NR1](#)