

Features

- Output Current of 1A Maximum
- Three-Terminal Adjustable or Fixed Outputs
- Maximum Input Voltage: 18V
- Fast Transient Response
- Current Limit, Safe Operating and Thermal Shutdown Protection
- Line Regulation: 0.2%
- Load Regulation: 0.4%
- Environment Temperature: -50°C~+140°C
- Available in SOT223-3 and TO-252 ,SOT89-3 Package

Application

- High Efficiency Linear Regulators
- Post Regulator for Switching DC/DC Converter
- Power Management for M/B and Graphic Card
- 2.85V Model for SCSI-2 Active Termination
- Battery Charger
- LCD Monitor and LCD TV
- DVD Decode Board
- ADSL Modem

Ordering Information

LD1117-1.8

Output voltage: 1.2=1.2V
 1.5=1.5V
 1.8=1.8V
 2.5=2.5V
 3.3=3.3V
 5.0=5.0V
 ADJ=Adjustable

Marking Information

LD1117-1.2 Marking:AMS1117-1.2
 LD1117-1.5 Marking:AMS1117-1.5
 LD1117-1.8 Marking:AMS1117-1.8
 LD1117-2.5 Marking:AMS1117-2.5
 LD1117-3.3 Marking:AMS1117-3.3
 LD1117-5.0 Marking:AMS1117-5.0
 LD1117-ADJ Marking:AMS1117-ADJ

Package and Pin Configuration

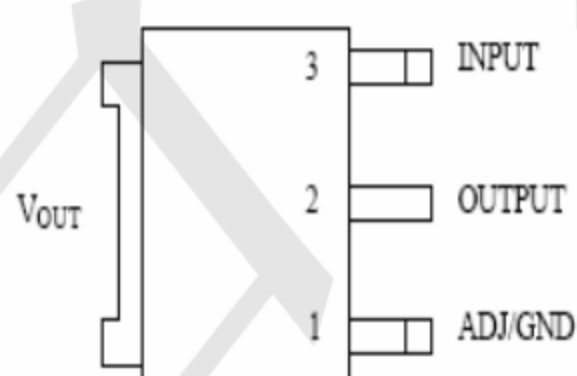

TO-252

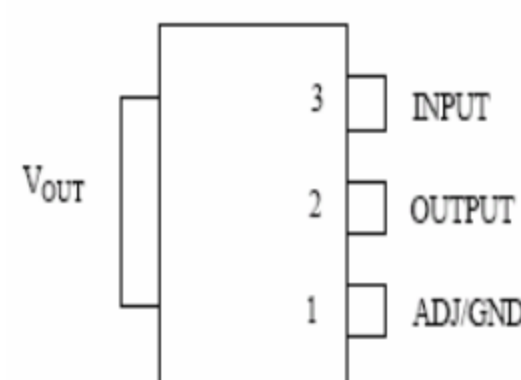

SOT-223

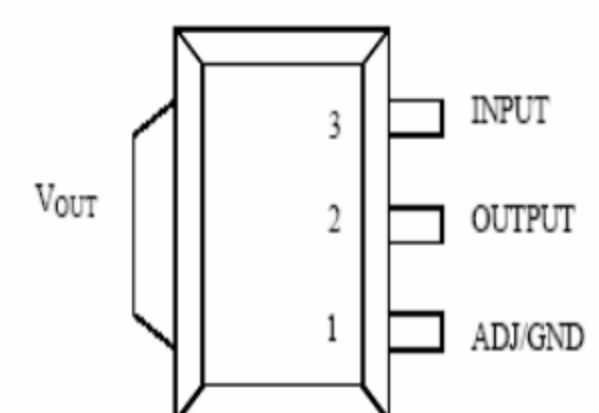

SOT89-3

Absolute Maximum Ratings

Maximum Input Voltage	18V
Operating Junction Temperature (T _J)	150 °C
Environment Temperature (T _A)	140 °C
Storage Temperature Range (T _s)	-65 °C to 150 °C
Lead Temperature (soldering, 10 seconds)	260 °C

Electrical Characteristics

V_{IN} = V_{OUT} + 2V, I_O = 10mA, and T_J = 25 °C, unless otherwise specified.

Symbol	Parameter	Test Conditions	Min	Typ	Max	Unit	
V _{REF}	Reference Voltage	I _{OUT} = 10mA, V _{IN} - V _{OUT} = 2V	1.238	1.250	1.262	V	
		10mA ≤ I _{OUT} ≤ 1A, 1.5V ≤ V _{IN} - V _{OUT} ≤ 12V	1.225	1.250	1.275		
V _{OUT}	Output Voltage	1.8V	I _{OUT} = 10mA, V _{IN} = 3.8V, T _J = 25°C	1.782	1.80	1.818	V
			0 ≤ I _{OUT} ≤ 1A, 3.2V ≤ V _{IN} ≤ 12V	1.764	1.80	1.836	
		2.5V	I _{OUT} = 10mA, V _{IN} = 4.5V, T _J = 25°C	2.475	2.50	2.525	
			0 ≤ I _{OUT} ≤ 1A, 3.9V ≤ V _{IN} ≤ 12V	2.450	2.50	2.550	
		3.3V	I _{OUT} = 10mA, V _{IN} = 5V, T _J = 25°C	3.267	3.30	3.333	
			0 ≤ I _{OUT} ≤ 1A, 4.75V ≤ V _{IN} ≤ 12V	3.234	3.30	3.366	
5.0V	I _{OUT} = 10mA, V _{IN} = 7V, T _J = 25°C	4.95	5.00	5.05			
	0 ≤ I _{OUT} ≤ 1A, 6.5V ≤ V _{IN} ≤ 12V	4.90	5.00	5.10			
ΔV _{OUT}	Line Regulation	ADJ	I _{OUT} = 10mA, 1.5V ≤ V _{IN} - V _{OUT} ≤ 13.775V		0.035	0.2	%
		Fixed	I _{OUT} = 10mA, V _{OUT} + 1.5V ≤ V _{IN} ≤ 15V		9	12	mV
ΔV _{OUT}	Load Regulation	ADJ	V _{IN} - V _{OUT} = 3V, 10mA ≤ I _{OUT} ≤ 1A		0.2	0.4	%
		Fixed	V _{IN} = V _{OUT} + 1.5V, 10mA ≤ I _{OUT} ≤ 1A		3	10	mV
V _{IN} - V _{OUT}	Dropout Voltage		ΔV _{OUT} , ΔV _{REF} = 1%, I _{OUT} = 100mA		1.11	1.20	V
			ΔV _{OUT} , ΔV _{REF} = 1%, I _{OUT} = 500mA		1.18	1.25	V
			ΔV _{OUT} , ΔV _{REF} = 1%, I _{OUT} = 1A		1.26	1.30	V
I _{CL}	Current Limit	V _{IN} - V _{OUT} = 2V, T _J = 25°C	1.25	1.4	1.6	A	
Minimum Load Current (Note 1)		Adjustable Version		5	10	mA	
I _q	Quiescent Current	Fixed	V _{IN} - V _{OUT} = 1.25V		4	8	mA
I _{ADJ}	ADJ Pin Current				55	120	uA
Temperature Stability						0.5	%
θ _{JC}	Thermal Resistor	SOT-223			20		°C/W
		TO-252			10		W

Typical Application

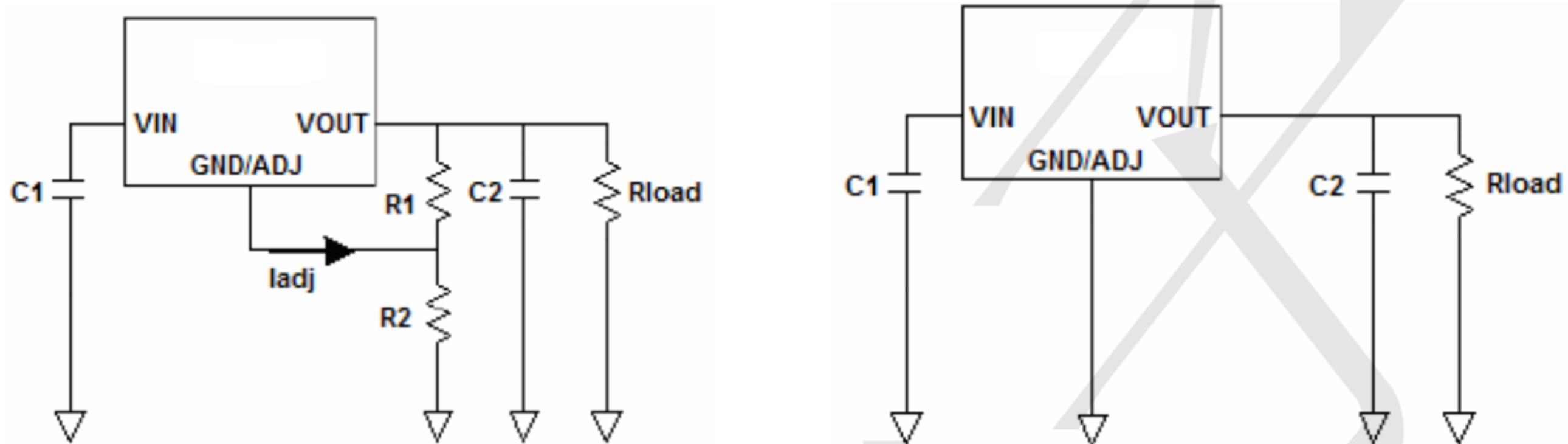

LD1117 adjustable output voltage

$$V_{OUT} = 1.25V(1 + R2/R1)$$

LD1117 fixed output

The TP1117 adjustable regulator provide 1.25V reference voltage. Any output voltage between 1.25V~13.8V can be available by choosing two external resistors.

Block Diagram

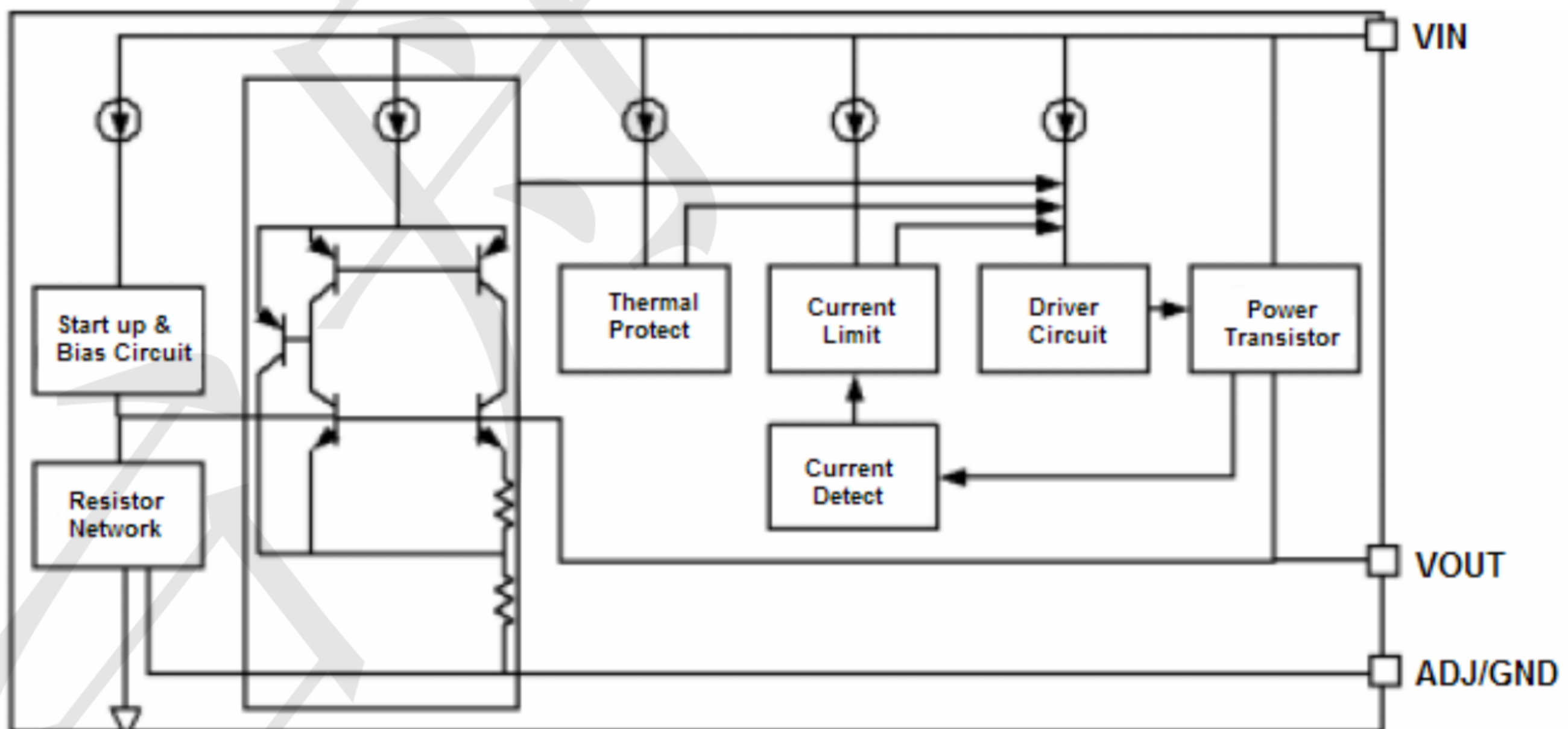

Typical Characteristics

1. Load Regulation

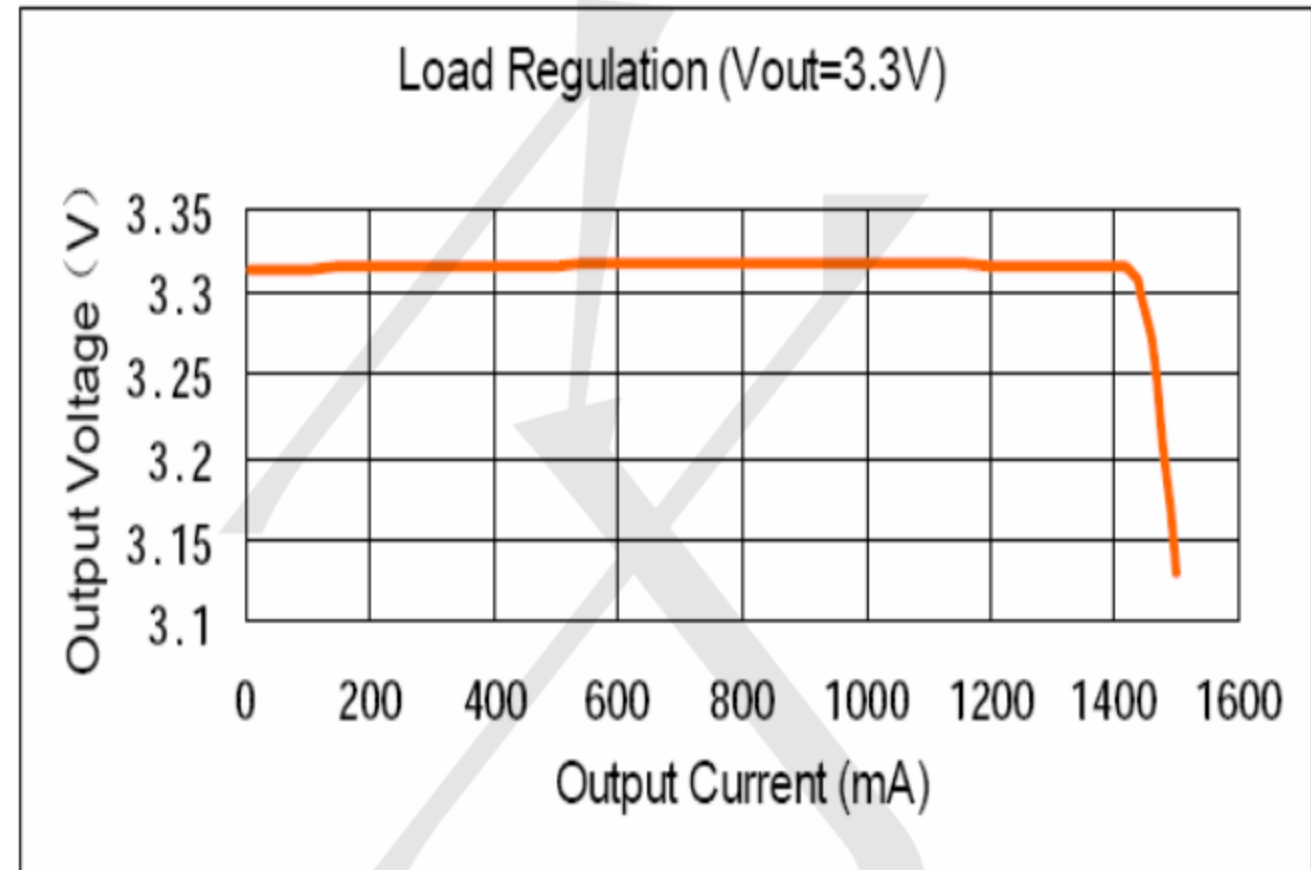
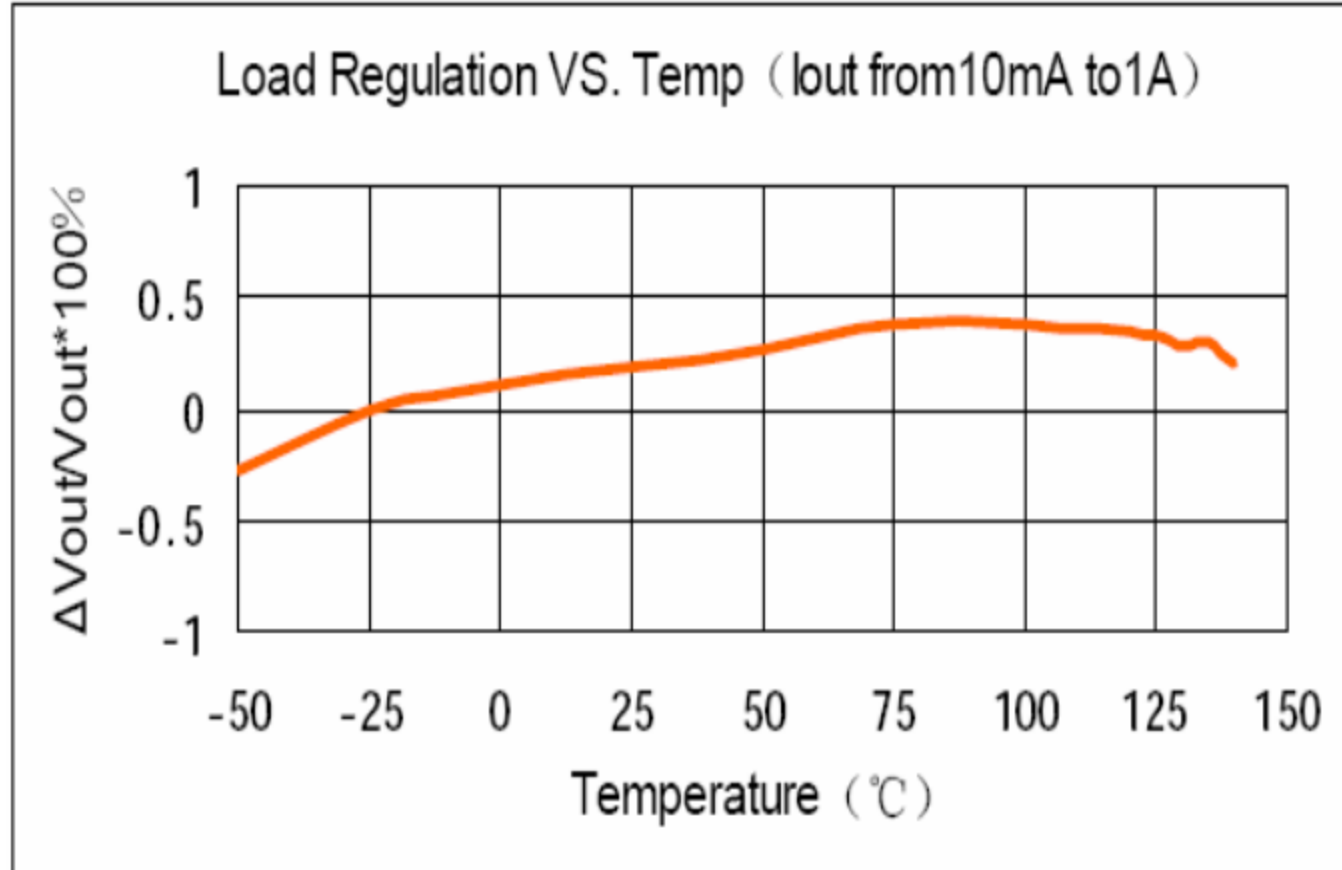

2. Line Regulation

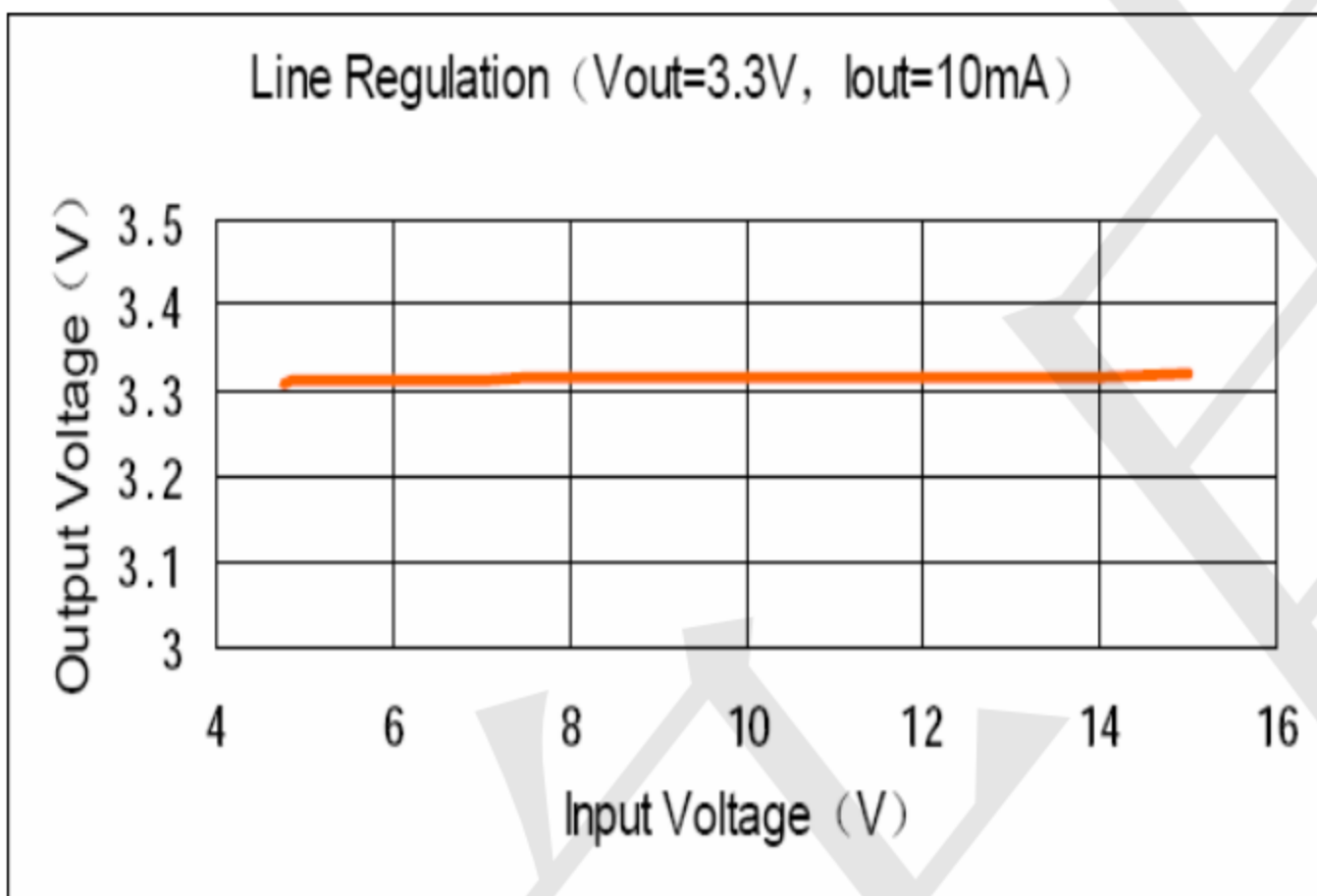

3. Dropout Voltage

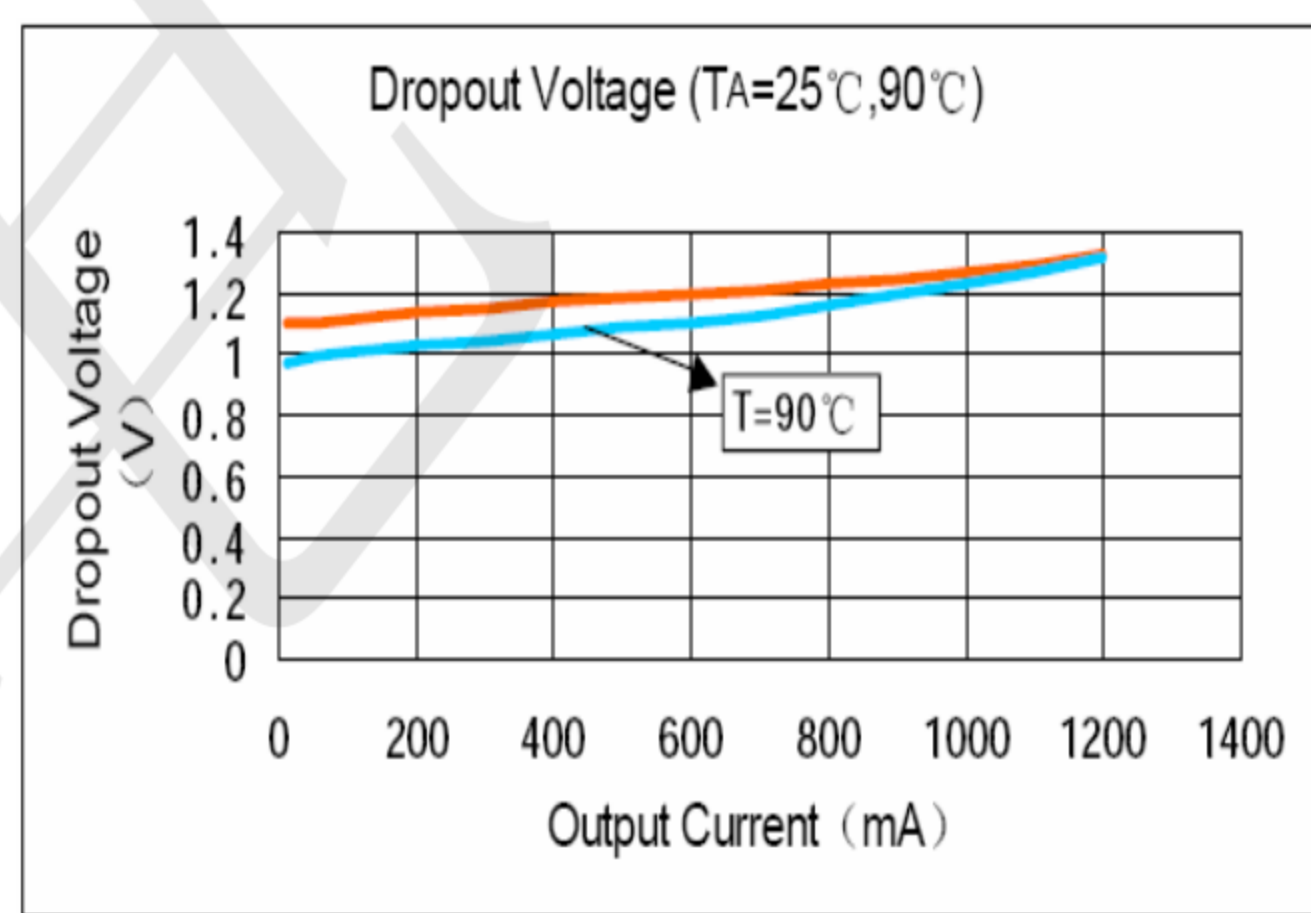

4. Temperature Stability

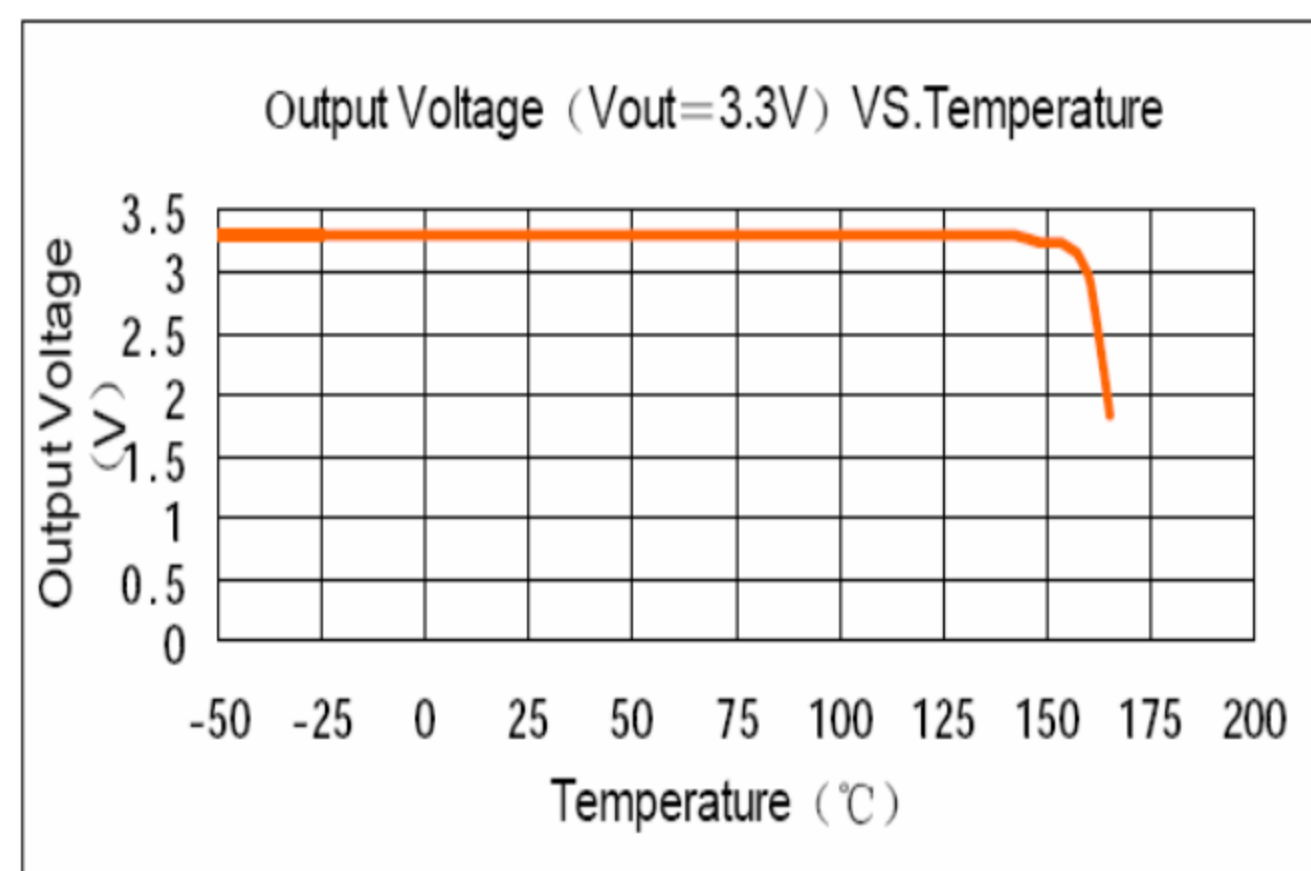
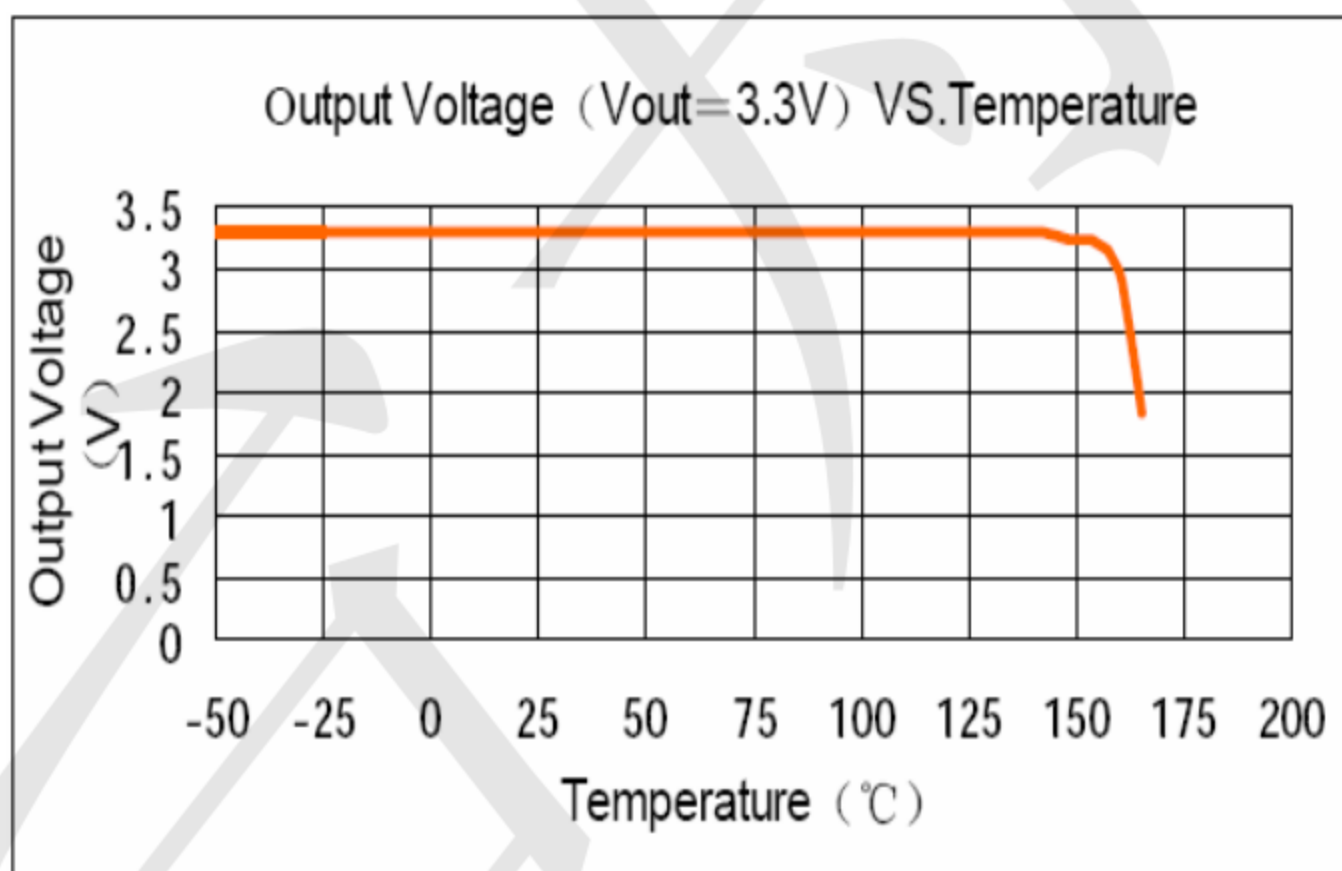

5. ADJ Pin Current vs. Temperature

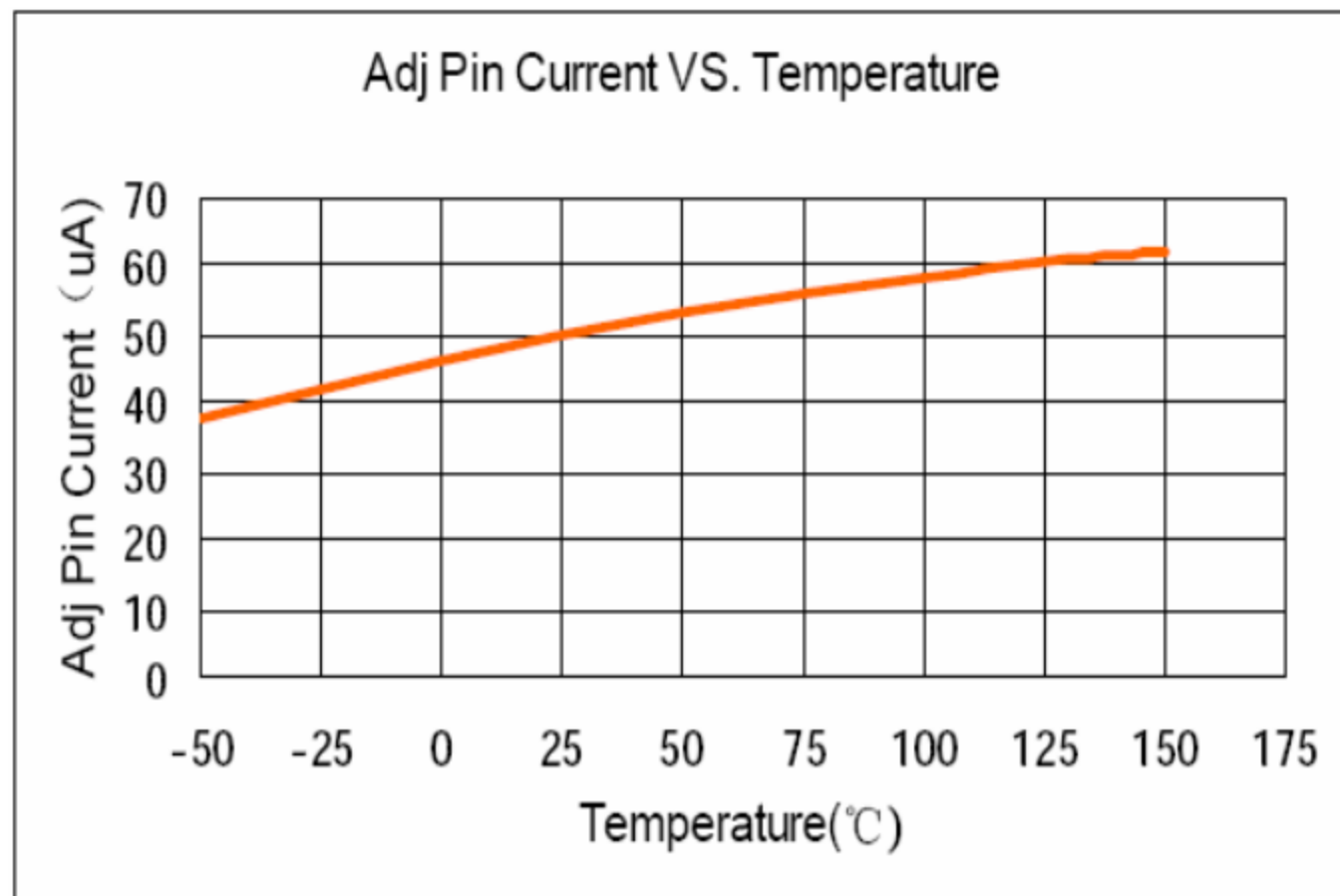

6. Load Transient Response

Load Current Change from 2mA to 500mA

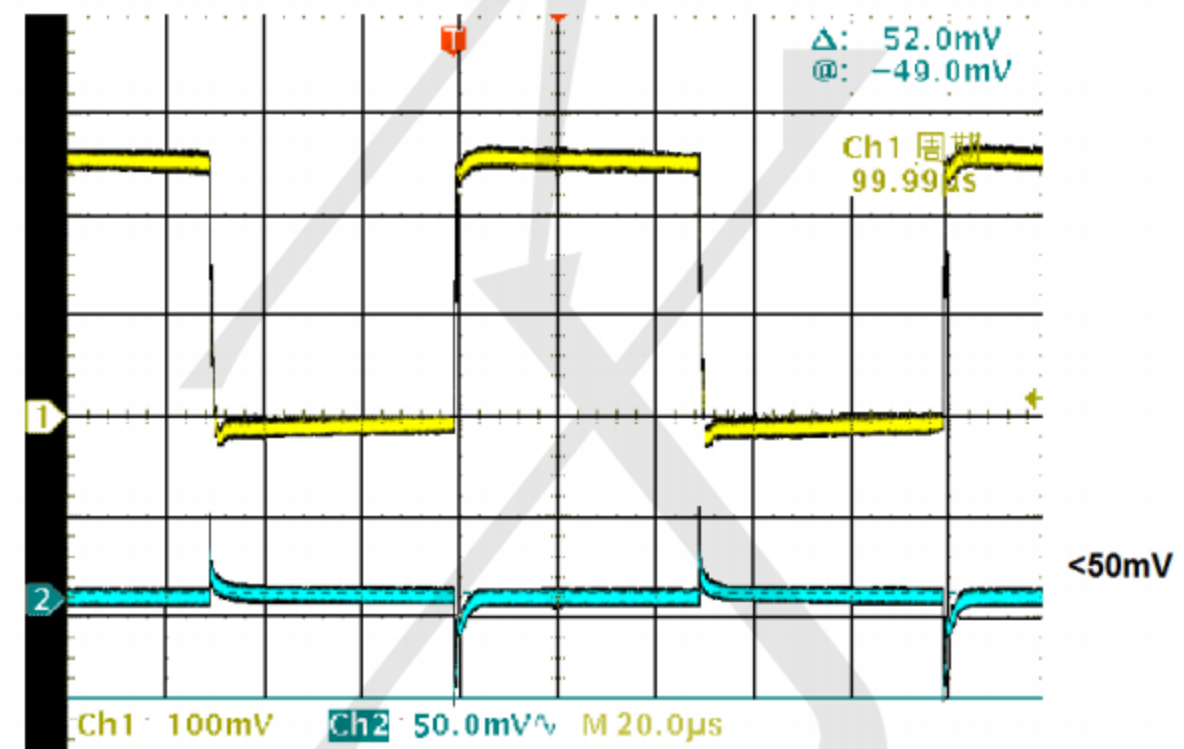

SOT89-3 Package Information

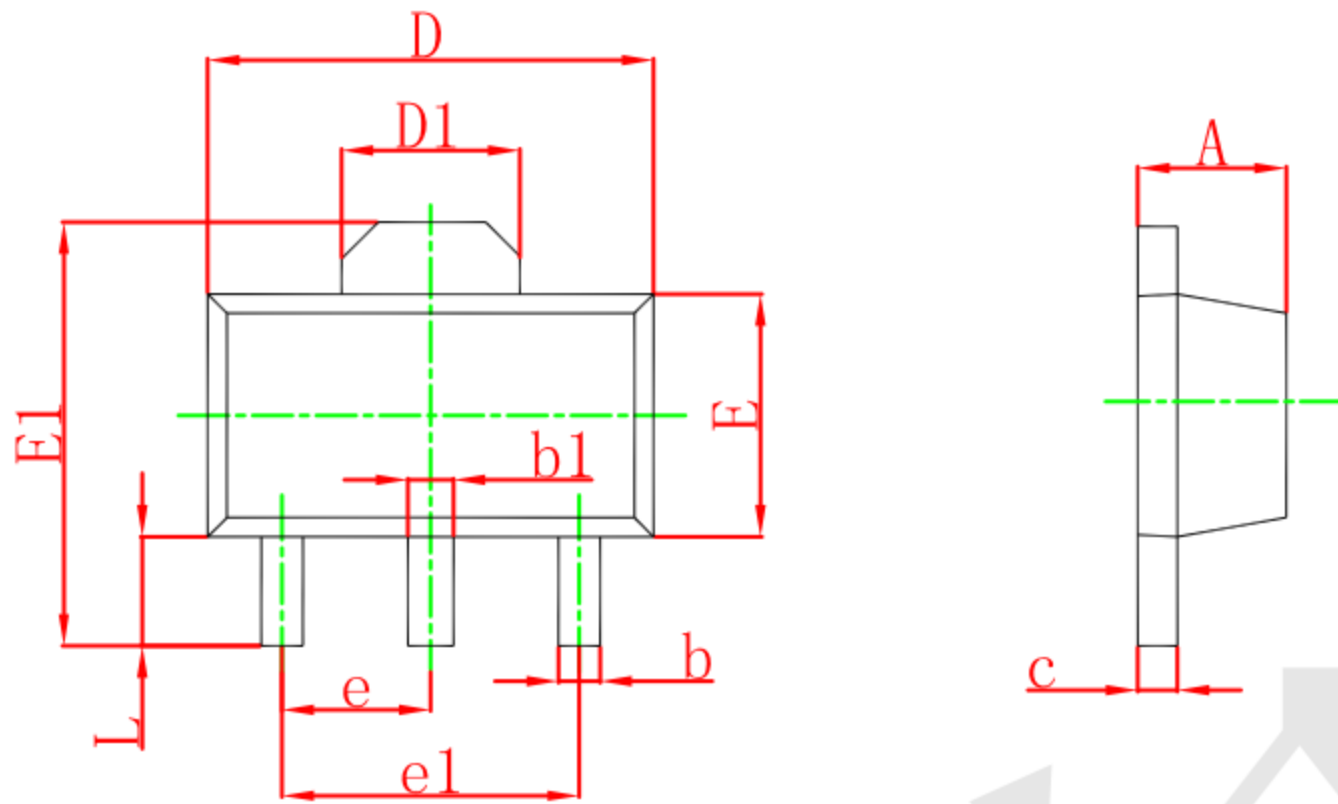

Symbol	Dimensions In Millimeters		Dimensions In Inches	
	Min	Max	Min	Max
A	1.400	1.600	0.055	0.063
b	0.320	0.520	0.013	0.020
b1	0.400	0.580	0.016	0.023
c	0.350	0.440	0.014	0.017
D	4.400	4.600	0.173	0.181
D1	1.550 REF.		0.061 REF.	
E	2.300	2.600	0.091	0.102
E1	3.940	4.250	0.155	0.167
e	1.500 TYP.		0.060 TYP.	
e1	3.000 TYP.		0.118 TYP.	
L	0.900	1.200	0.035	0.047

TO252-2 Package Information

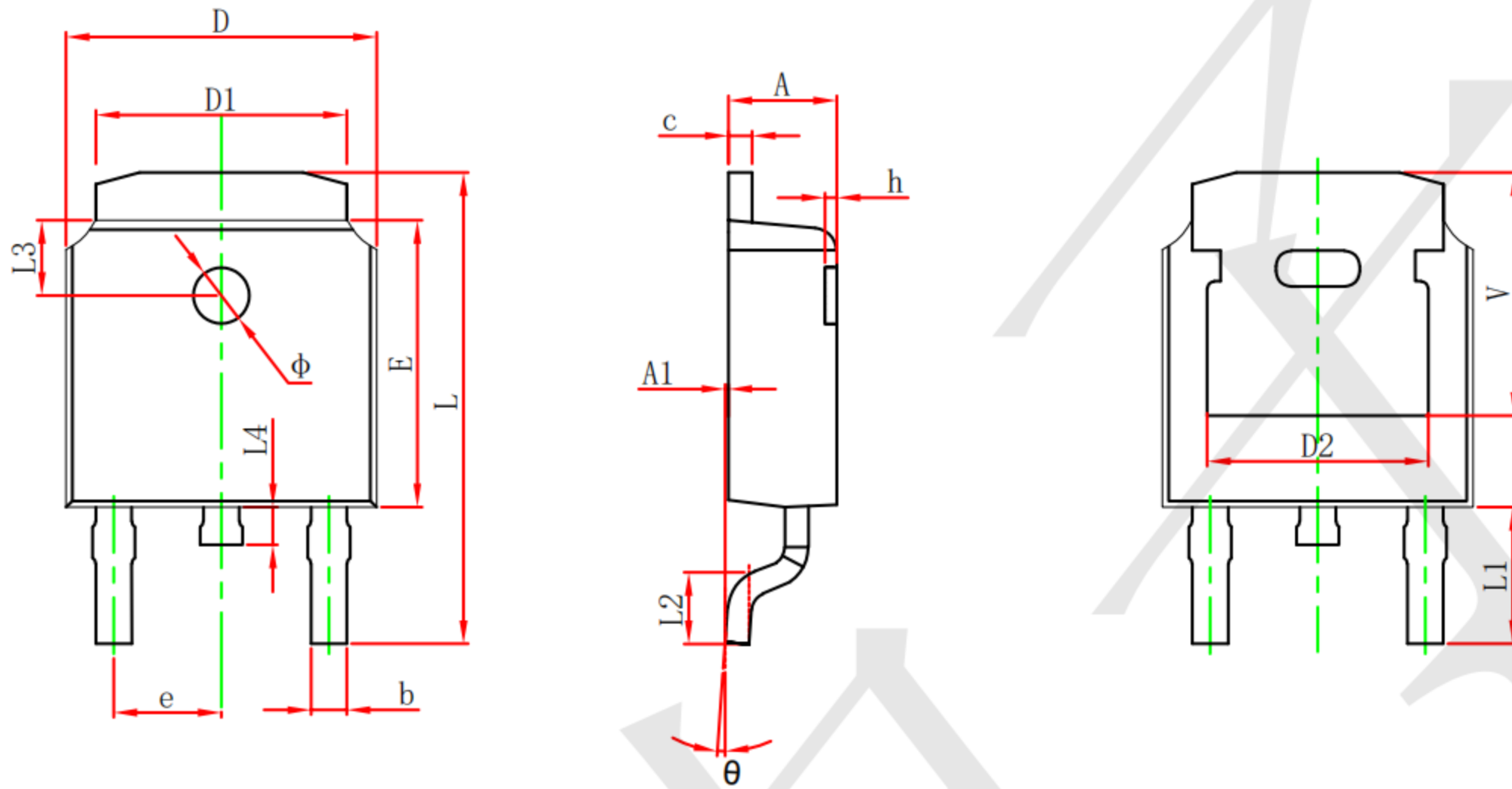

Symbol	Dimensions In Millimeters		Dimensions In Inches	
	Min.	Max.	Min.	Max.
A	2.200	2.400	0.087	0.094
A1	0.000	0.127	0.000	0.005
b	0.635	0.770	0.025	0.030
c	0.460	0.580	0.018	0.023
D	6.500	6.700	0.256	0.264
D1	5.100	5.460	0.201	0.215
D2	4.830 REF.		0.190 REF.	
E	6.000	6.200	0.236	0.244
e	2.186	2.386	0.086	0.094
L	9.712	10.312	0.382	0.406
L1	2.900 REF.		0.114 REF.	
L2	1.400	1.700	0.055	0.067
L3	1.600 REF.		0.063 REF.	
L4	0.600	1.000	0.024	0.039
phi	1.100	1.300	0.043	0.051
theta	0°	8°	0°	8°
h	0.000	0.300	0.000	0.012
V	5.250 REF.		0.207 REF.	

SOT223 Package Information

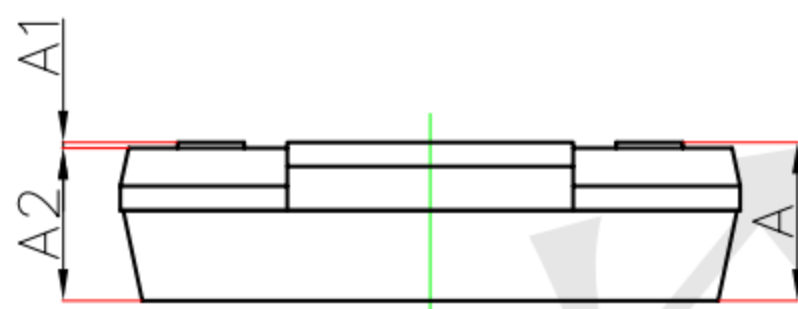
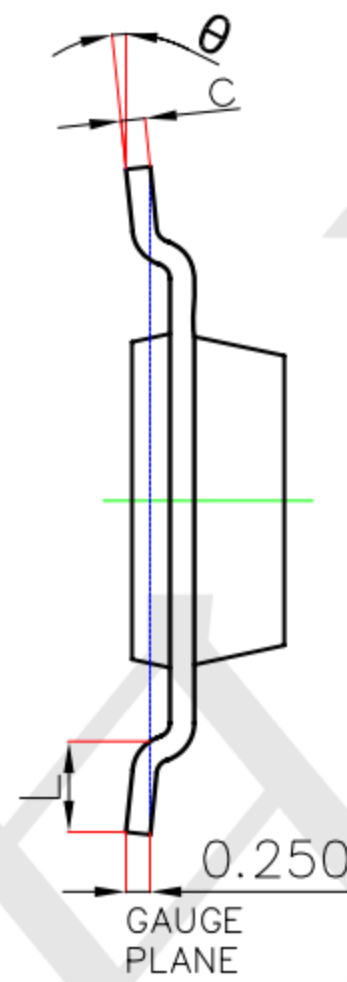
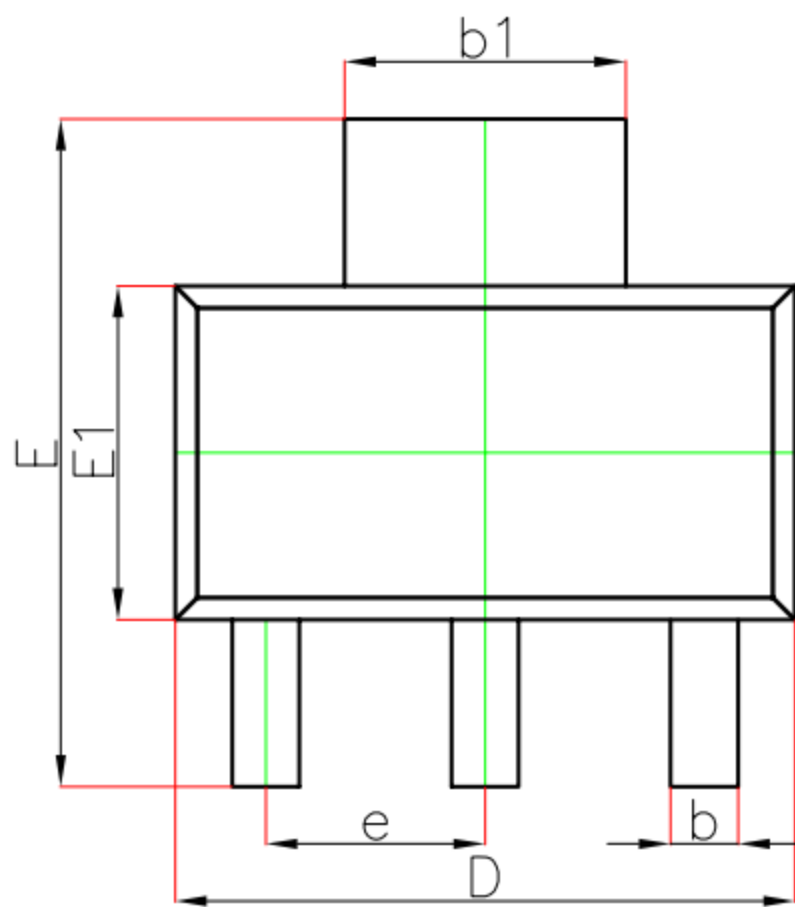

Symbol	Dimensions In Millimeters		Dimensions In Inches	
	Min.	Max.	Min.	Max.
A	—	1.800	—	0.071
A1	0.020	0.100	0.001	0.004
A2	1.500	1.700	0.059	0.067
b	0.660	0.840	0.026	0.033
b_1	2.900	3.100	0.114	0.122
c	0.230	0.350	0.009	0.014
D	6.300	6.700	0.248	0.264
E	6.700	7.300	0.264	0.287
E1	3.300	3.700	0.130	0.146
e	2.300(BSC)		0.091(BSC)	
L	0.750	—	0.030	—
θ	0°	10°	0°	10°

X-ON Electronics

Largest Supplier of Electrical and Electronic Components

Click to view similar products for [Linear Voltage Regulators](#) category:

Click to view products by [TECH PUBLIC](#) manufacturer:

Other Similar products are found below :

[LV5684PVD-XH](#) [MCDTSA6-2R](#) [L7815ACV-DG](#) [LV56801P-E](#) [UA7805CKC](#) [714954EB](#) [ZMR500QFTA](#) [BA033LBSG2-TR](#)
[NCV78M05ABDTRKG](#) [LV5680P-E](#) [L79M05T-E](#) [L78LR05D-MA-E](#) [NCV317MBTG](#) [NTE7227](#) [MP2018GZD-33-P](#) [MP2018GZD-5-P](#)
[LV5680NPVC-XH](#) [ZTS6538SE](#) [UA78L09CLP](#) [UA78L09CLPR](#) [CAT6221-PPTD-GT3](#) [MC78M09CDTRK](#) [NCV51190MNTAG](#)
[BL1118CS8TR1833](#) [BL8563CKETR18](#) [BL8077CKETR33](#) [BL9153-33CC3TR](#) [BL9161G-15BADRN](#) [BL9161G-28BADRN](#)
[BRCO7530MMC](#) [CJ7815B-TFN-ARG](#) [LM317C](#) [GM7333K](#) [GM7350K](#) [XC6206P332MR](#) [HT7533](#) [LM7912S/TR](#) [LT1764S/TR](#) [LM7805T](#)
[LM338T](#) [LM1117IMP-3.3/TR](#) [HT1117AM-3.3](#) [HT7550S](#) [AMS1117-3.3](#) [HT7150S](#) [78L12](#) [HT7550](#) [HT7533-1](#) [HXY6206I-2.5](#) [HT7133](#)