



Product Summary

- V_{DSS}=60V
- I_D= 0.5A
- R_{DS(ON)}= 1.7Ω@V_{GS}=-10V

Typical Applications

- Line current interrupter in telephone sets
- High speed and line transformer drivers

Package and Pin Configuration

SOT-23



Circuit diagram

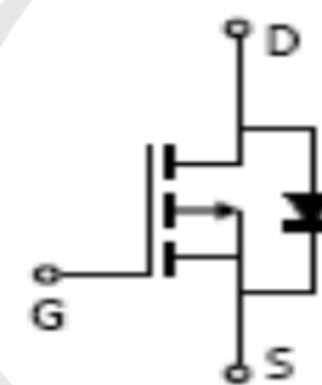

Marking:610T

Maximum Ratings (@T_A=25°C unless otherwise specified)

| Symbol | Parameter | Value | Units |
|------------------|---------------------------|-------------|-------|
| V _{DSS} | Drain-Source Voltage | -60 | V |
| V _{GSS} | Gate -Source Voltage | ±20 | V |
| I _D | Continuous Drain Current | -0.5 | A |
| P _D | Power Dissipation | 0.36 | W |
| R _{θJA} | Junction-to-Air | 350 | °C/W |
| T _J | Junction Temperature | 150 | °C |
| T _{STG} | Storage Temperature Range | -55 to +150 | °C |

**Electrical Characteristics** (@T_A=25°C unless otherwise specified)

| Symbol | Parameter | Test conditions | MIN | TYP | MAX | UNIT |
|---|--|--|-----|------|------|------|
| OFF Characteristics | | | | | | |
| V _{DSS} | Drain-Source Breakdown Voltage | V _{GS} =0V, I _D =-250μA | -60 | - | - | V |
| I _{DSS} | Drain to Source Leakage Current | V _{DS} =-50V, V _{GS} =0V | - | - | -100 | nA |
| I _{GSS} | Gate-body Leakage | V _{GS} =±20V, V _{DS} =0V | - | - | ±1 | uA |
| ON Characteristics ^(NOTE2) | | | | | | |
| R _{DS(ON)} | Static Drain-Source On-resistance | V _{GS} =-4.5V, I _D =-0.2A | - | - | 3 | Ω |
| | | V _{GS} =-10V, I _D =-0.5A | - | 1.7 | 2 | |
| V _{GS(TH)} | Gate Threshold Voltage | V _{DS} = V _{GS} , I _D =-250uA | -1 | -1.8 | -3 | V |
| Dynamic Characteristics ^(NOTE3) | | | | | | |
| C _{iss} | Input Capacitance | V _{GS} = 0V | - | 50 | - | pF |
| C _{oss} | Output Capacitance | V _{DS} = -25V | - | 15 | - | |
| C _{rss} | Reverse Transfer Capacitance | f = 1.0MHz | - | 5 | - | |
| Switching Characteristics ^(NOTE3) | | | | | | |
| t _{d(on)} | Turn-on Delay Time | V _{DD} =-30V, I _D =-0.27A V _{GS} =-10V, R _G =6Ω | - | 2.5 | 5 | nS |
| t _r | Turn-on Rise Time | | - | 6.3 | 13 | |
| t _{d(off)} | Turn-Off Delay Time | | - | 10 | 20 | |
| t _f | Turn-Off Fall Time | | - | 4.8 | 9.6 | |
| Q _g | Total Gate Charge | V _{DS} =-25V, I _D =-0.1A V _{GS} =-5V | - | 0.9 | 1.3 | nC |
| Q _{gs} | Gate-Source Charge | | - | 0.2 | - | |
| Q _{gd} | Gate-Drain Charge | | - | 0.3 | - | |
| Source-Drain Diode Characteristics | | | | | | |
| V _{SD} | Diode Forward Voltage ^(NOTE1) | I _{SD} =-0.26A, V _{GS} =0V | - | -0.8 | -1.4 | V |
| I _s | Diode Continuous Forward Current | T _C =25°C | - | - | -0.5 | A |



Ratings and Characteristic Curves ($T_A=25^\circ\text{C}$ unless otherwise noted)

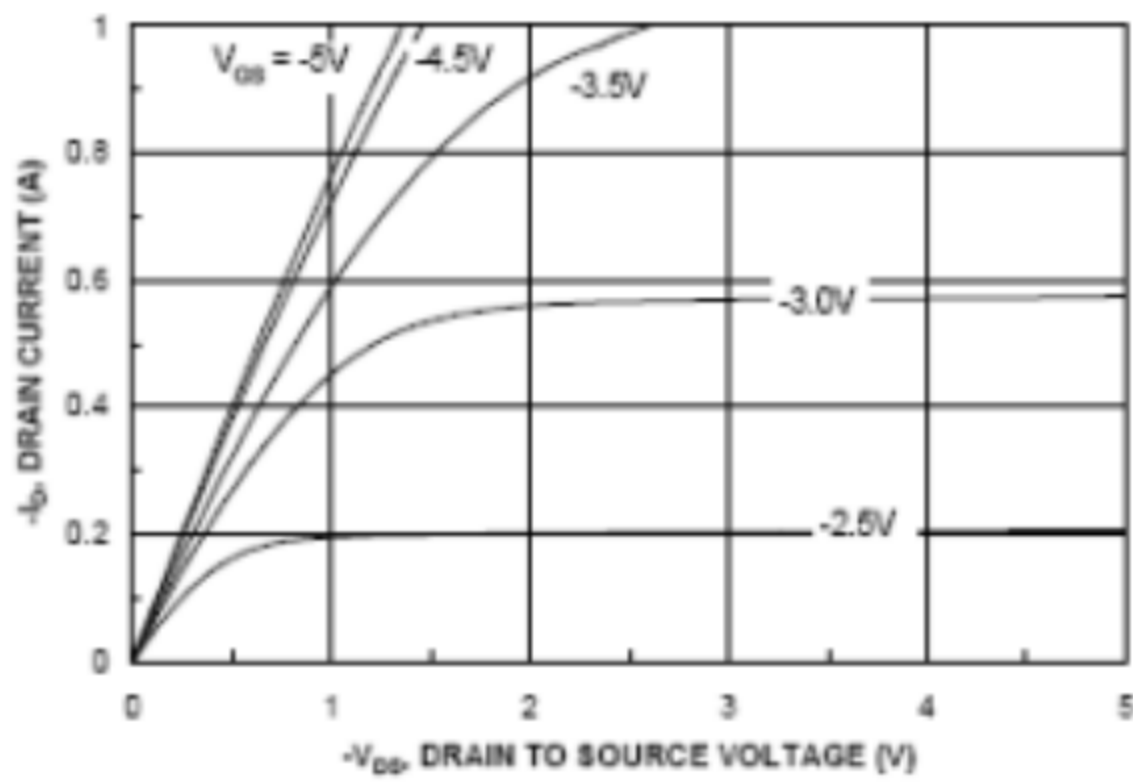

Figure 1. On-Region Characteristics.

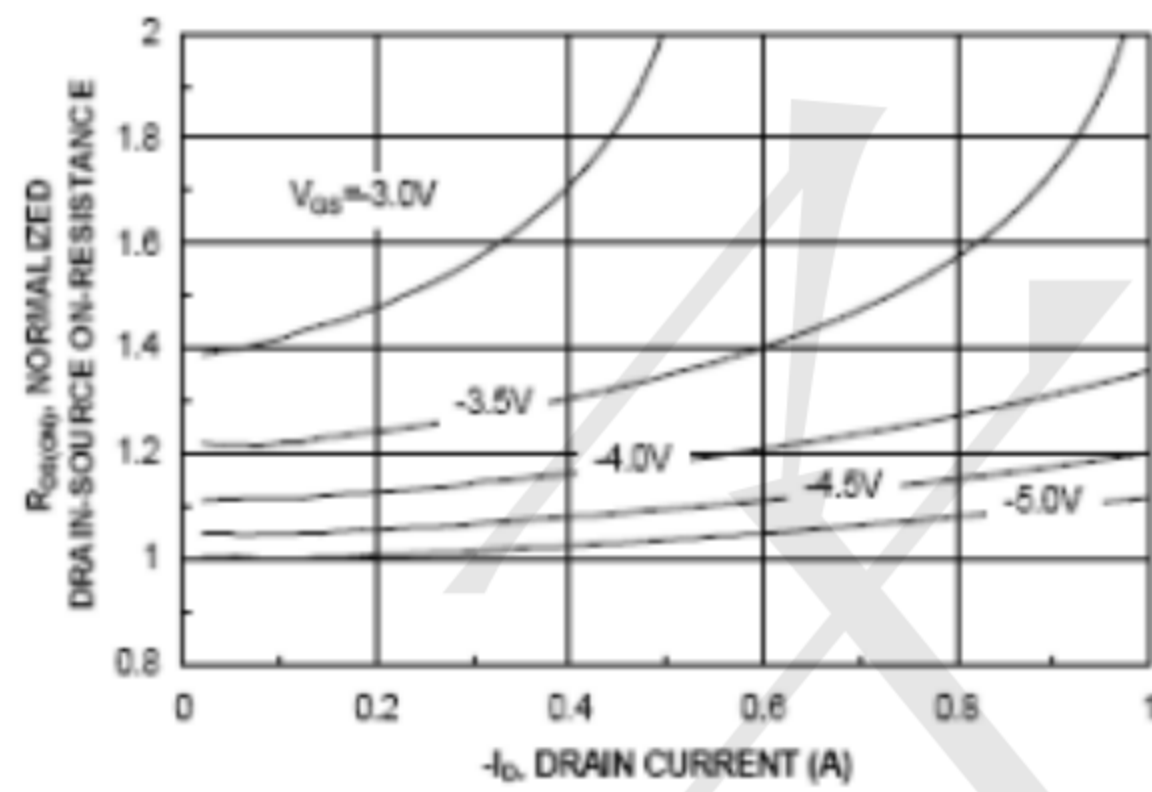

Figure 2. On-Resistance Variation with Drain Current and Gate Voltage.

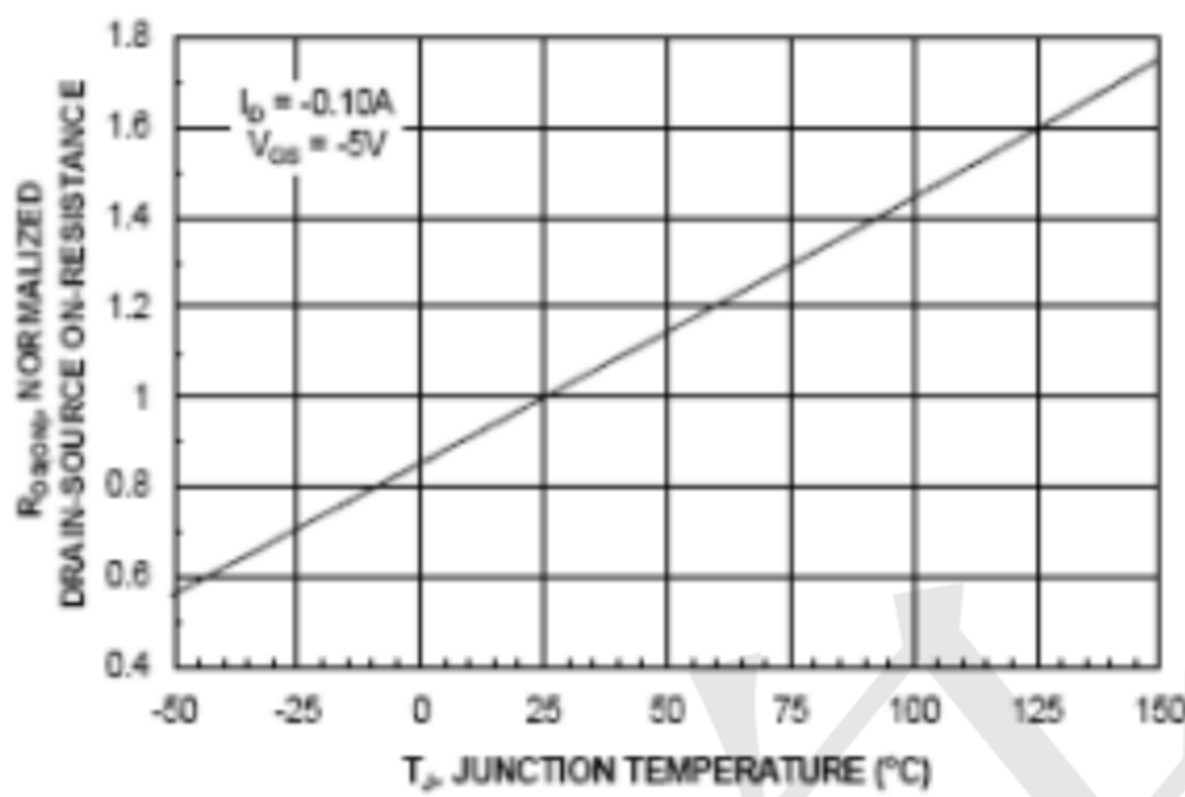

Figure 3. On-Resistance Variation with Temperature.

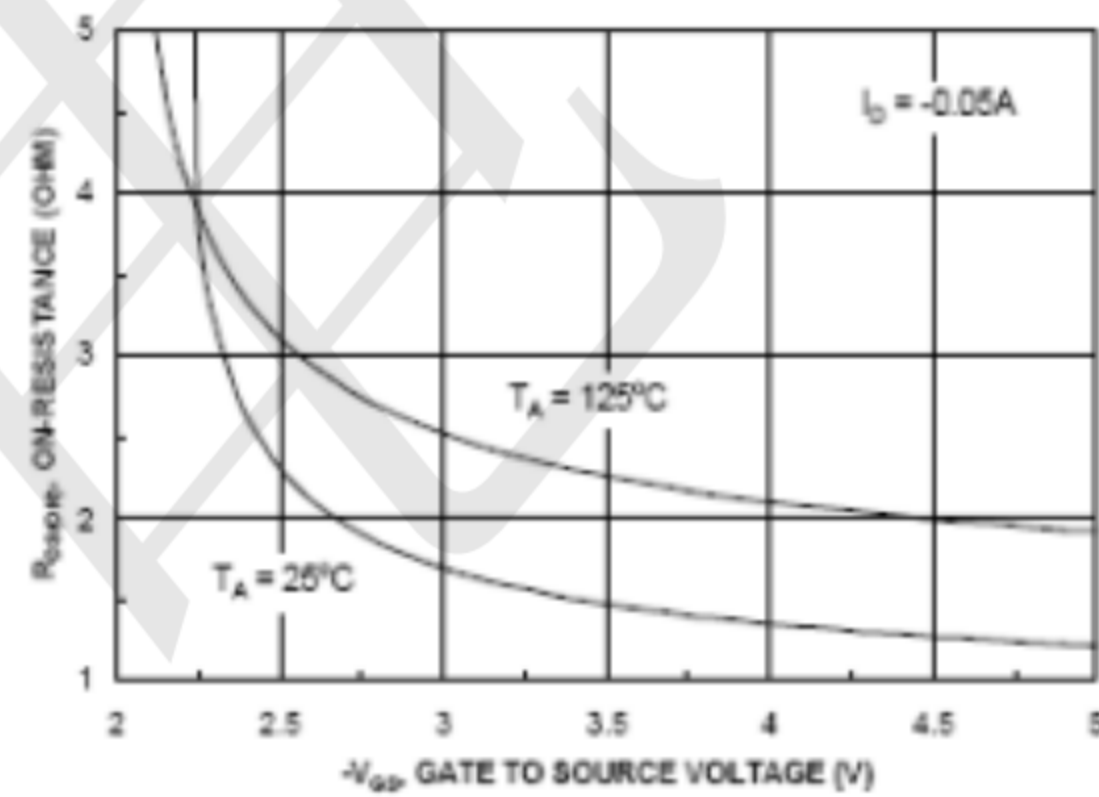

Figure 4. On-Resistance Variation with Gate-to-Source Voltage.

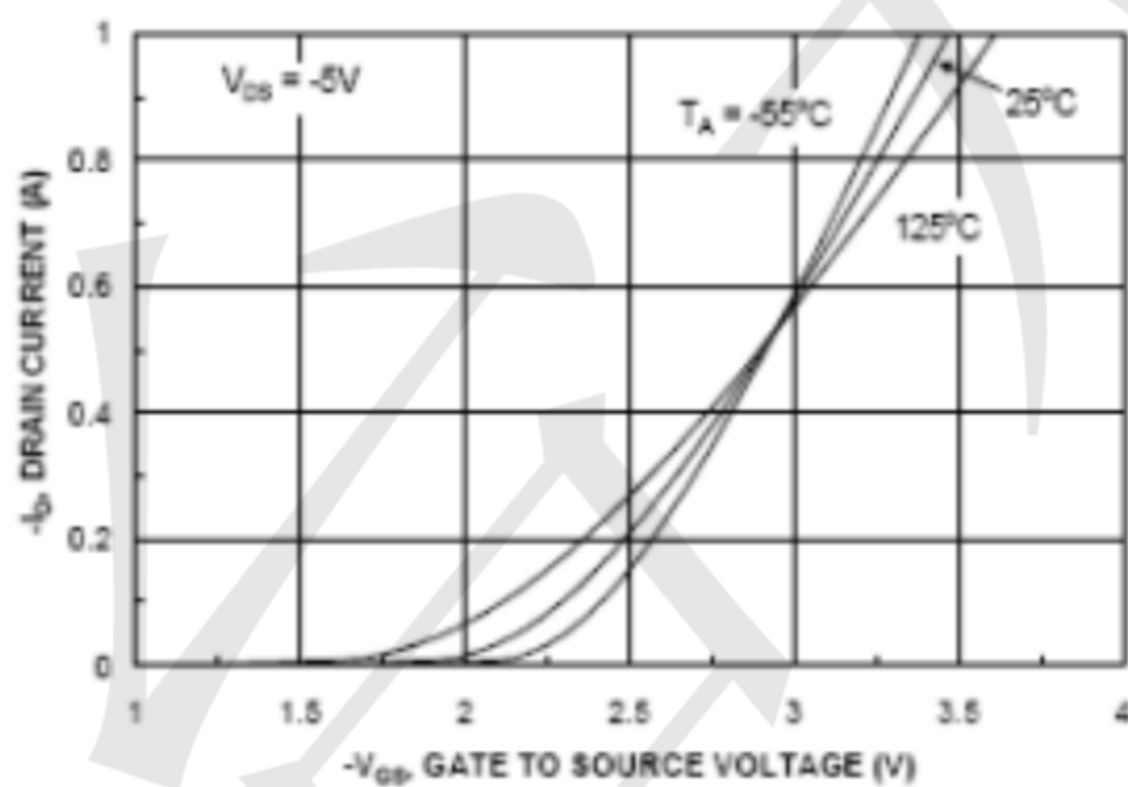

Figure 5. Transfer Characteristics.

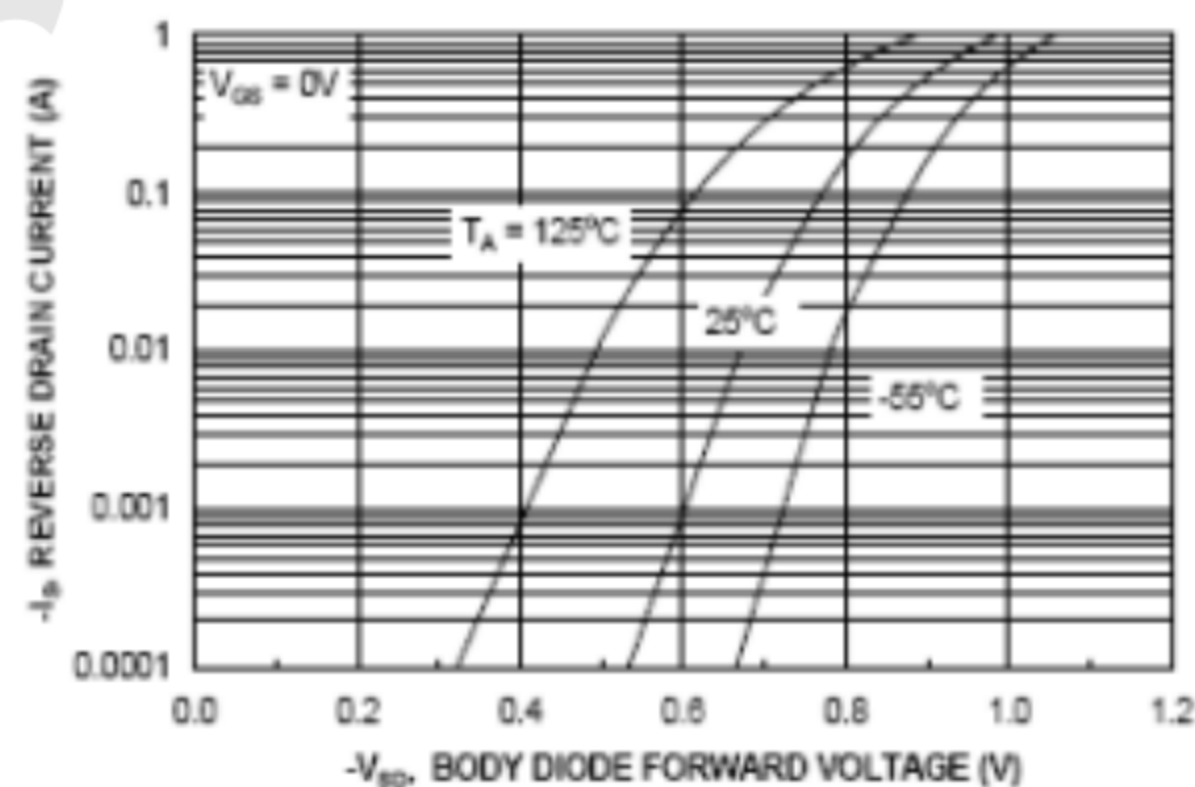

Figure 6. Body Diode Forward Voltage Variation with Source Current and Temperature.

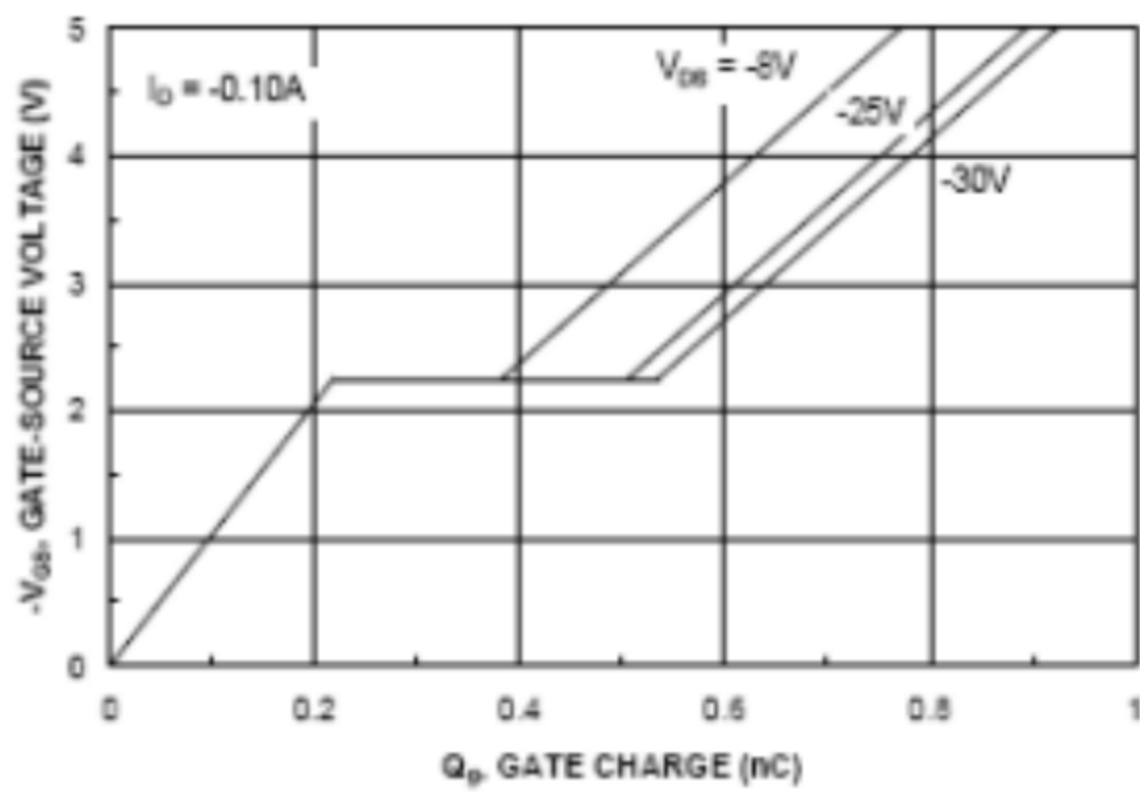

Figure 7. Gate Charge Characteristics.

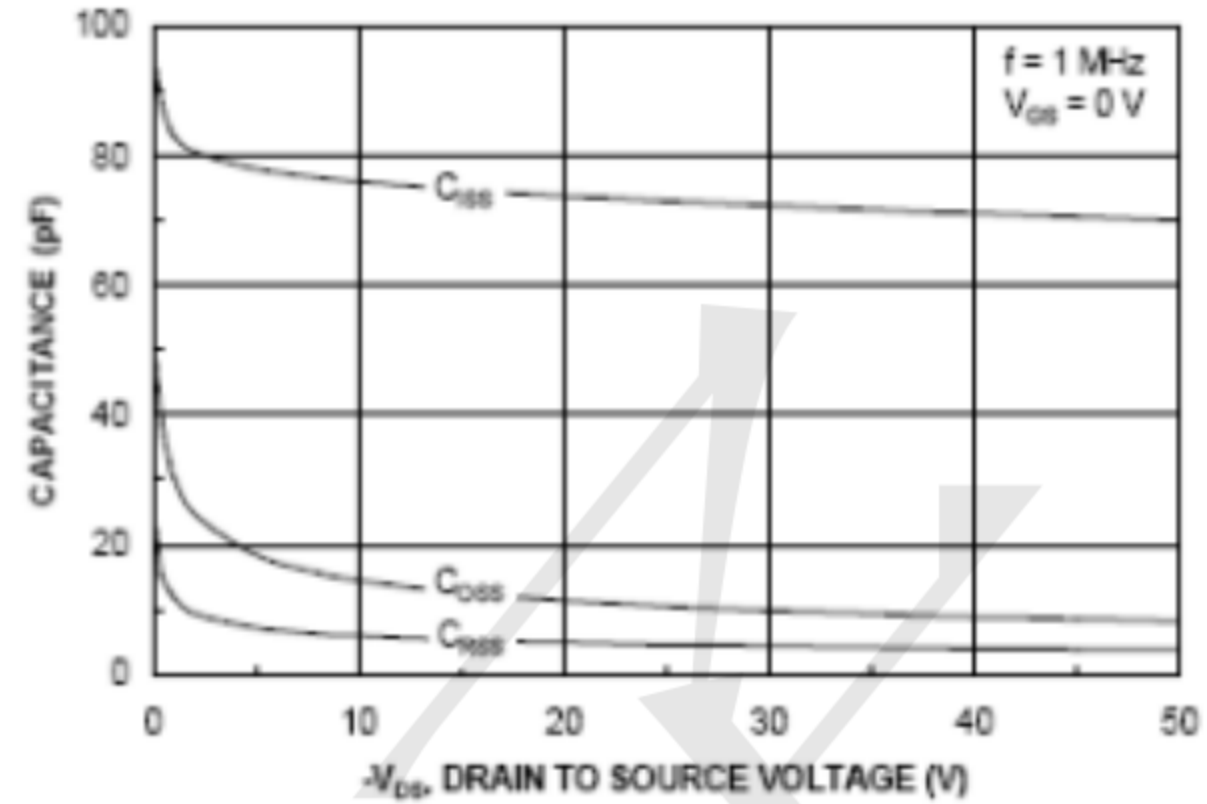

Figure 8. Capacitance Characteristics.

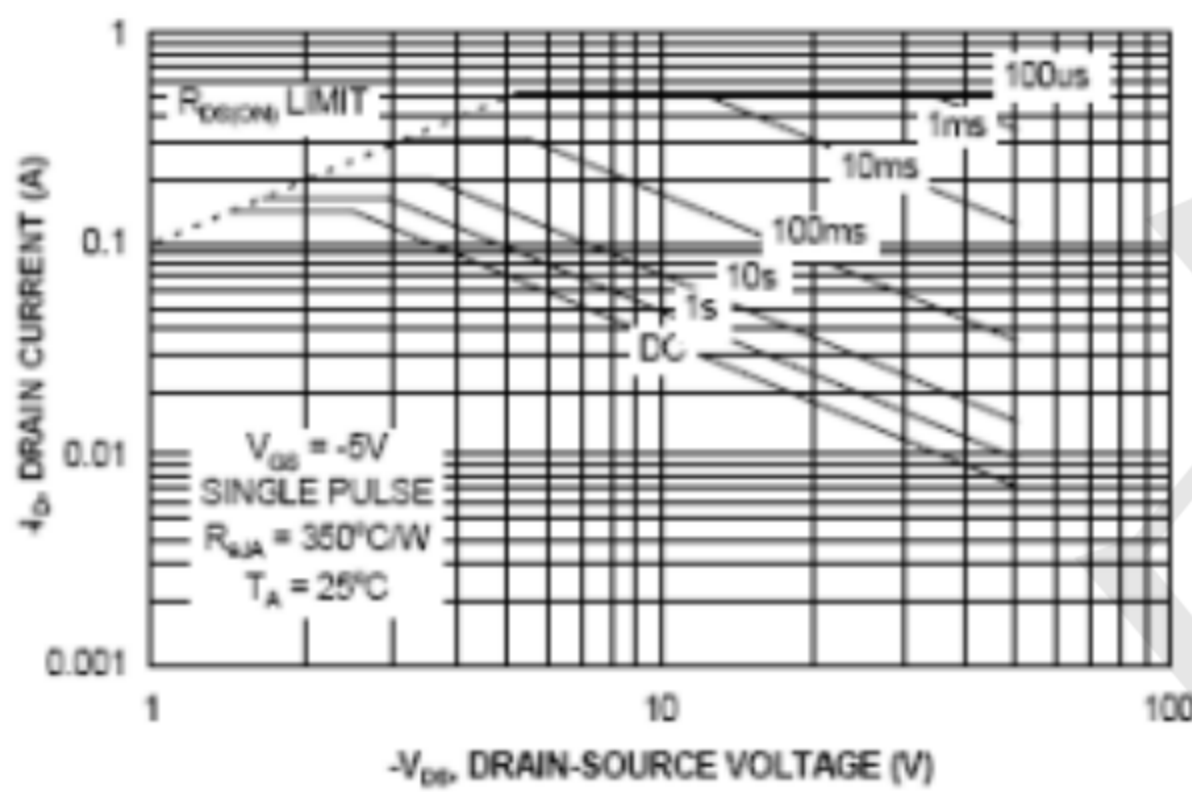

Figure 9. Maximum Safe Operating Area.

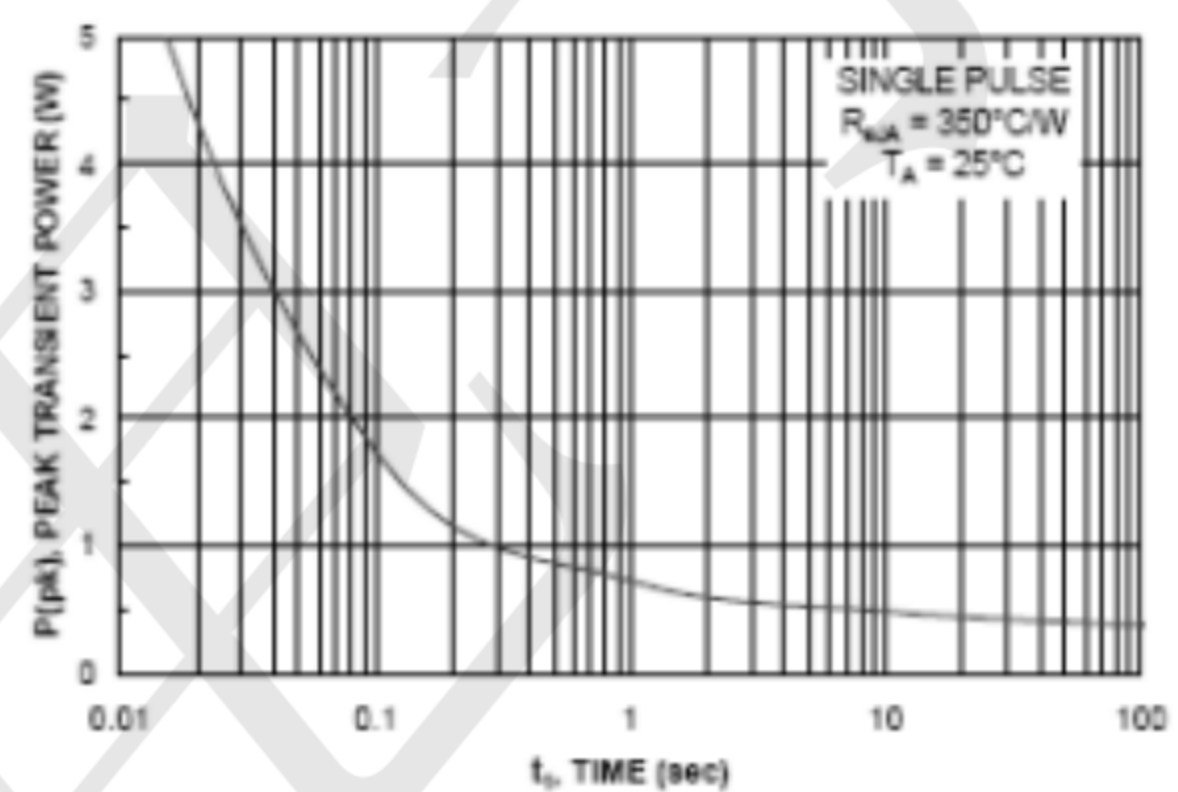

Figure 10. Single Pulse Maximum Power Dissipation.

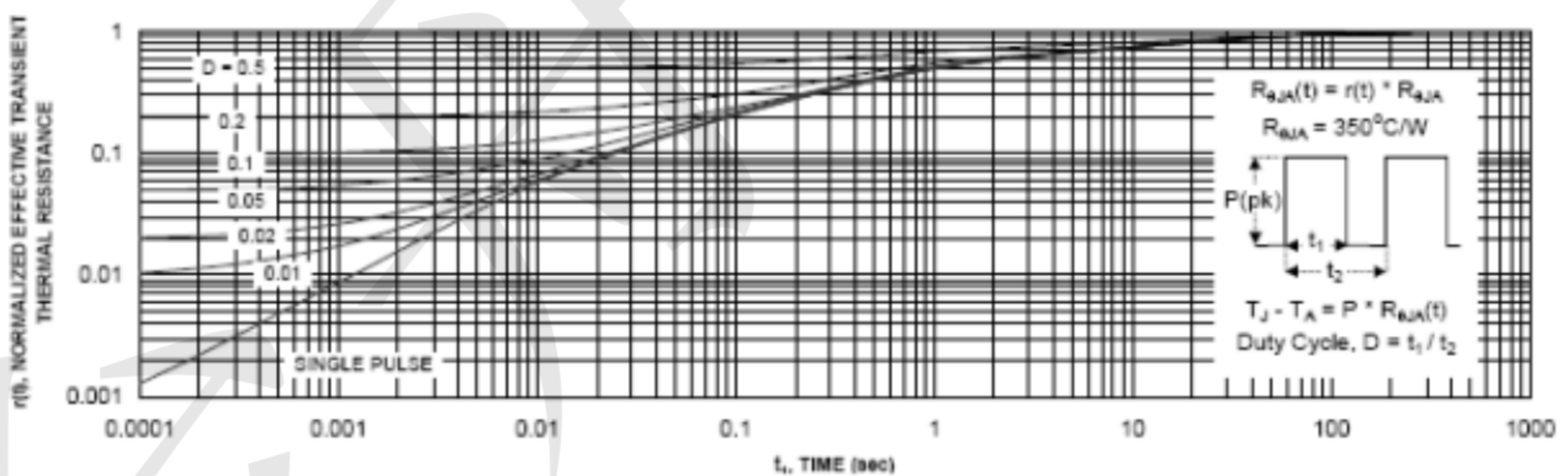
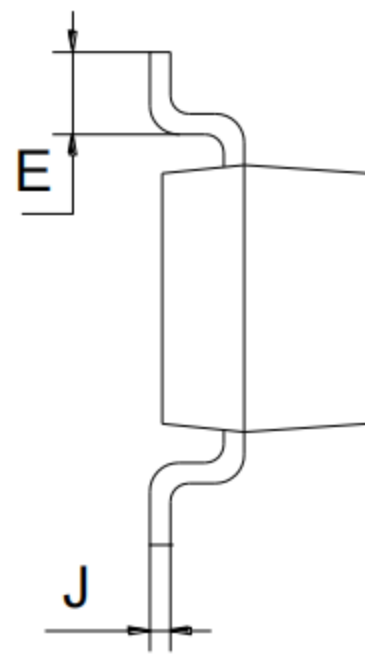
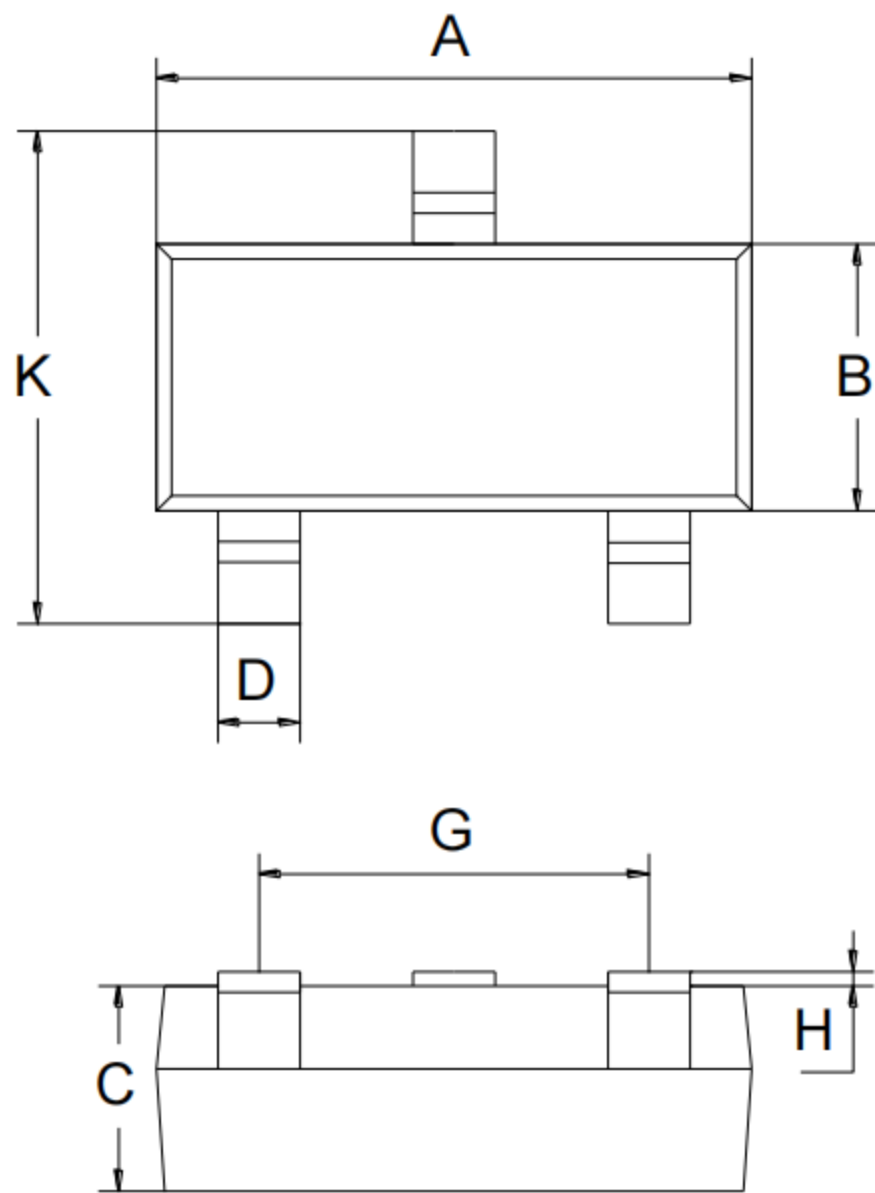

Figure 11. Transient Thermal Response Curve.

Thermal characterization performed using the conditions described in Note 1a. Transient thermal response will change depending on the circuit board design.



SOT-23 Package Information (T_A=25°C unless otherwise noted)



| SOT-23 | | |
|--------|------|------|
| Dim | Min | Max |
| A | 2.70 | 3.10 |
| B | 1.10 | 1.50 |
| C | 0.90 | 1.10 |
| D | 0.30 | 0.50 |
| E | 0.35 | 0.48 |
| G | 1.80 | 2.00 |
| H | 0.02 | 0.10 |
| J | 0.05 | 0.15 |
| K | 2.20 | 2.60 |

X-ON Electronics

Largest Supplier of Electrical and Electronic Components

Click to view similar products for [MOSFET](#) category:

Click to view products by [TECH PUBLIC](#) manufacturer:

Other Similar products are found below :

[IRFD120](#) [JANTX2N5237](#) [2SK2267\(Q\)](#) [BUK455-60A/B](#) [TK100A10N1,S4X\(S](#) [MIC4420CM-TR](#) [VN1206L](#) [NDP4060](#) [SI4482DY](#)
[IRS2092STRPBF-EL](#) [IPS70R2K0CEAKMA1](#) [TK31J60W5,S1VQ\(O](#) [TK31J60W,S1VQ\(O](#) [TK16J60W,S1VQ\(O](#) [2SK2614\(TE16L1,Q\)](#)
[DMN1017UCP3-7](#) [EFC2J004NUZTDG](#) [P85W28HP2F-7071](#) [DMN1053UCP4-7](#) [NTE2384](#) [DMC2700UDMQ-7](#) [DMN2080UCB4-7](#)
[DMN61D9UWQ-13](#) [US6M2GTR](#) [DMN31D5UDJ-7](#) [DMP22D4UFO-7B](#) [IPS60R3K4CEAKMA1](#) [DMN1006UCA6-7](#) [DMN16M9UCA6-7](#)
[STF5N65M6](#) [IRF40H233XTMA1](#) [STU5N65M6](#) [DMN6022SSD-13](#) [DMN13M9UCA6-7](#) [DMTH10H4M6SPS-13](#) [IPS60R360PFD7SAKMA1](#)
[DMN2990UFB-7B](#) [SSM3K35CT,L3F](#) [IPLK60R1K0PFD7ATMA1](#) [2N7002W-G](#) [MCAC30N06Y-TP](#) [IPWS65R035CFD7AXKSA1](#)
[MCQ7328-TP](#) [SSM3J143TU,LXHF](#) [DMN12M3UCA6-7](#) [PJMF280N65E1_T0_00201](#) [PJMF380N65E1_T0_00201](#)
[PJMF280N60E1_T0_00201](#) [PJMF600N65E1_T0_00201](#) [PJMF900N65E1_T0_00201](#)