

Features

- $V_{DS} = 30V, I_D = 3A$
- $R_{DS(ON)} < 95m\Omega @ V_{GS}=4.5V$
- $R_{DS(ON)} < 75m\Omega @ V_{GS}=10V$

Typical Applications

- Load switch
- PWM application

Shipping Quantity

- 3000pcs / Tape & Reel



Marking: TR3.R

Circuit Diagram

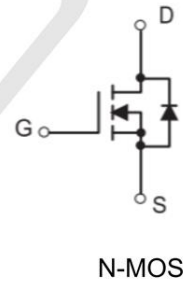

Absolute Maximum Ratings ($T_A=25^\circ\text{C}$ unless otherwise noted)

Parameter	Symbol	Limit	Unit
Drain-Source Voltage	V_{DS}	30	V
Gate-Source Voltage	V_{GS}	± 20	V
Drain Current-Continuous	I_D	3	A
Drain Current-Pulsed ^(Note 1)	I_{DM}	10	A
Maximum Power Dissipation	P_D	0.9	W
Operating Junction and Storage Temperature Range	T_J, T_{STG}	-55 To 150	$^\circ\text{C}$

Thermal Characteristic

Thermal Resistance, Junction-to-Ambient ^(Note 2)	$R_{\theta JA}$	138	$^\circ\text{C/W}$
---	-----------------	-----	--------------------

Electrical Characteristics ($T_A=25^\circ\text{C}$ unless otherwise noted)

Parameter	Symbol	Condition	Min	Typ	Max	Unit
Off Characteristics						
Drain-Source Breakdown Voltage	BV_{DSS}	$V_{GS}=0V, I_D=250\mu A$	30	-	-	V
Zero Gate Voltage Drain Current	I_{DSS}	$V_{DS}=20V, V_{GS}=0V$	-	-	1	μA
Gate-Body Leakage Current	I_{GSS}	$V_{GS}=\pm 20V, V_{DS}=0V$	-	-	± 100	nA
On Characteristics (Note 3)						
Gate Threshold Voltage	$V_{GS(th)}$	$V_{DS}=V_{GS}, I_D=250\mu A$	1	1.5	3.0	V
Drain-Source On-State Resistance	$R_{DS(on)}$	$V_{GS}=10V, I_D=3A$	-	55	75	$m\Omega$
		$V_{GS}=4.5V, I_D=2A$	-	70	95	$m\Omega$
Forward Transconductance	g_{FS}	$V_{DS}=5V, I_D=3A$	14	-	-	S
Dynamic Characteristics (Note 4)						
Input Capacitance	C_{iss}	$V_{DS}=10V, V_{GS}=0V,$ $F=1.0MHz$	-	235	-	PF
Output Capacitance	C_{oss}		-	35	-	PF
Reverse Transfer Capacitance	C_{rss}		-	18	-	PF
Switching Characteristics (Note 4)						
Turn-on Delay Time	$t_{d(on)}$	$V_{DD}=15V, I_D=1A$ $V_{GS}=10V, R_{GEN}=6\Omega$	-	3.5	-	nS
Turn-on Rise Time	t_r		-	1.5	-	nS
Turn-Off Delay Time	$t_{d(off)}$		-	17.5	-	nS
Turn-Off Fall Time	t_f		-	2.5	-	nS
Total Gate Charge	Q_g	$V_{DS}=15V, I_D=3A, V_{GS}=10V$	-	10	-	nC
Gate-Source Charge	Q_{gs}		-	0.95	-	nC
Gate-Drain Charge	Q_{gd}		-	1.6	-	nC
Drain-Source Diode Characteristics						
Diode Forward Voltage (Note 3)	V_{SD}	$V_{GS}=0V, I_S=3A$	-	-	1.2	V
Diode Forward Current (Note 2)	I_S		-	-	3	A

Typical Performance Characteristics ($T_A=25^\circ\text{C}$ unless otherwise Specified)

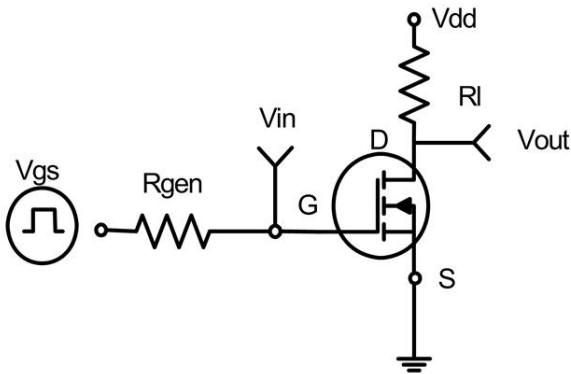

Figure 1: Switching Test Circuit

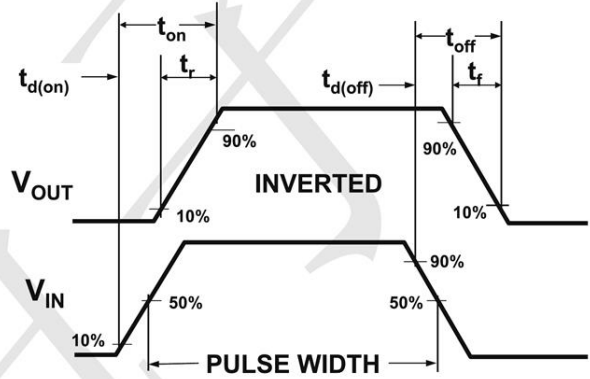

Figure 2: Switching Waveforms

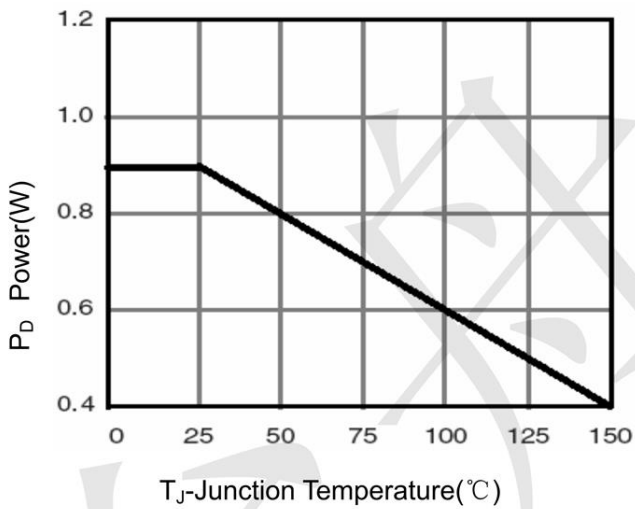

Figure 3 Power Dissipation

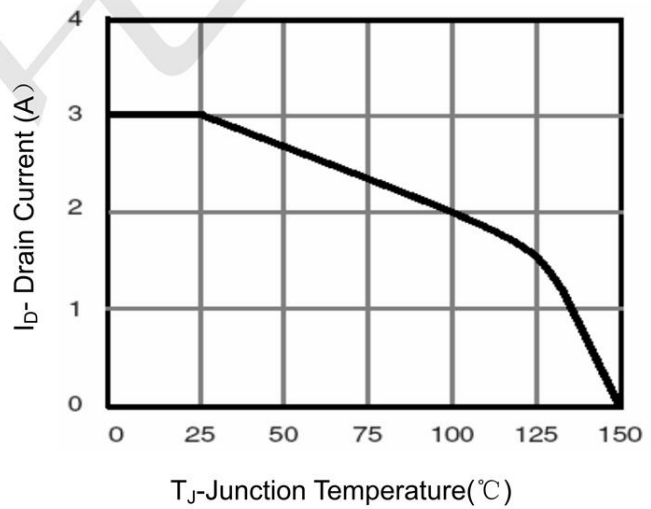

Figure 4 Drain Current

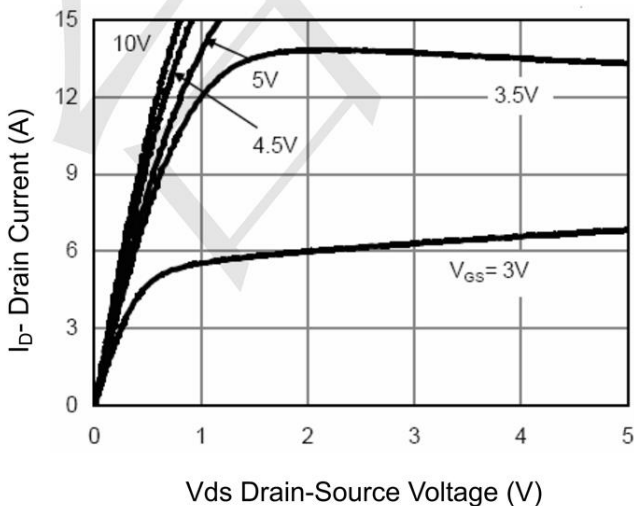

Figure 5 Output Characteristics

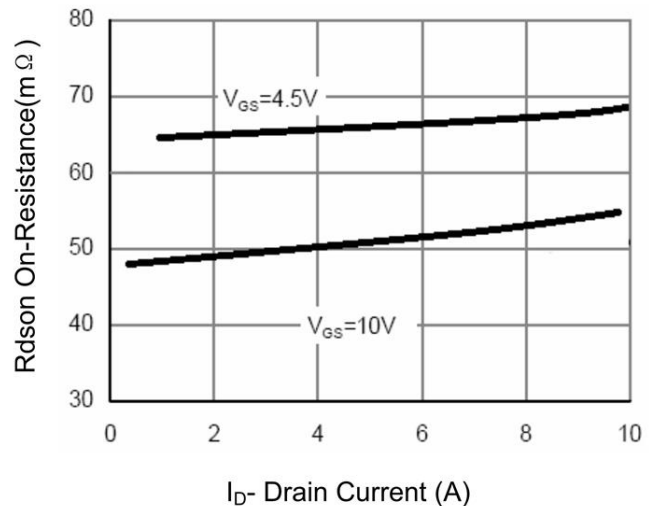

Figure 6 Drain-Source On-Resistance

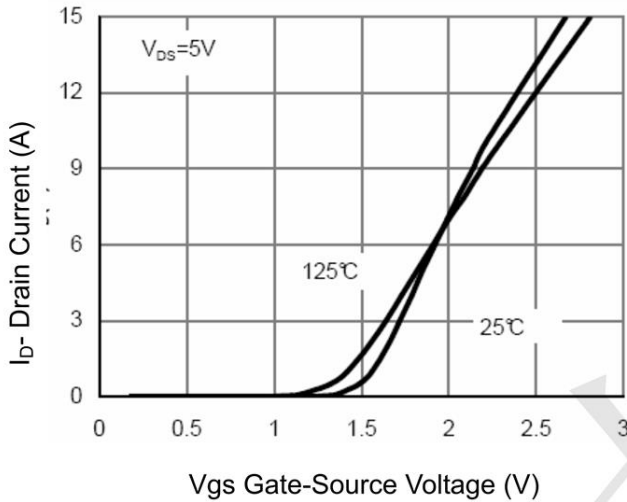

Figure 7 Transfer Characteristics

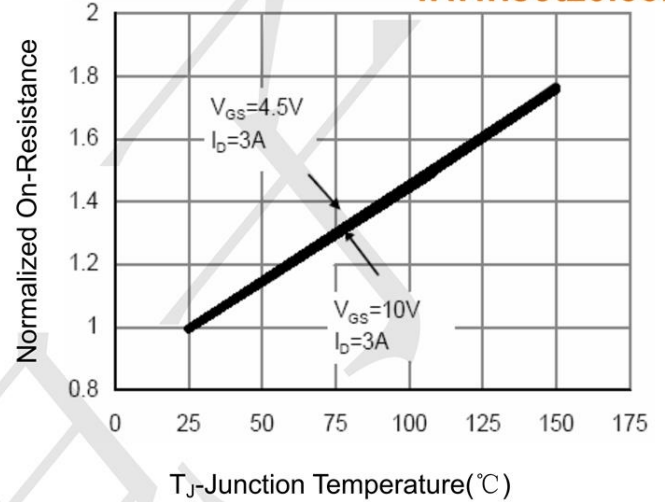

Figure 8 Drain-Source On-Resistance

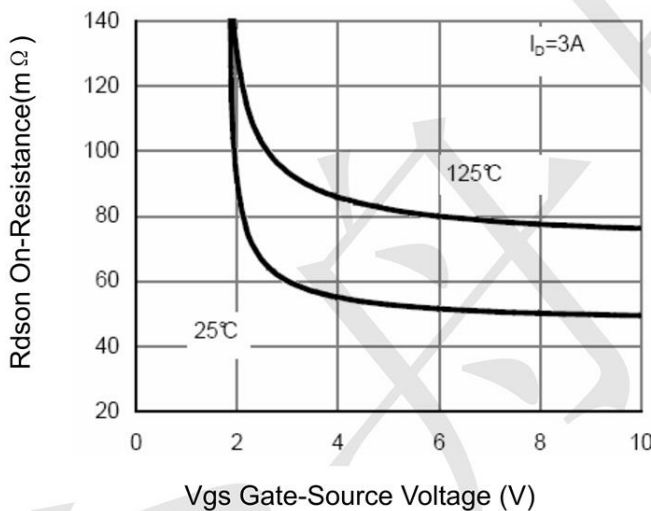

Figure 9 Rdson vs Vgs

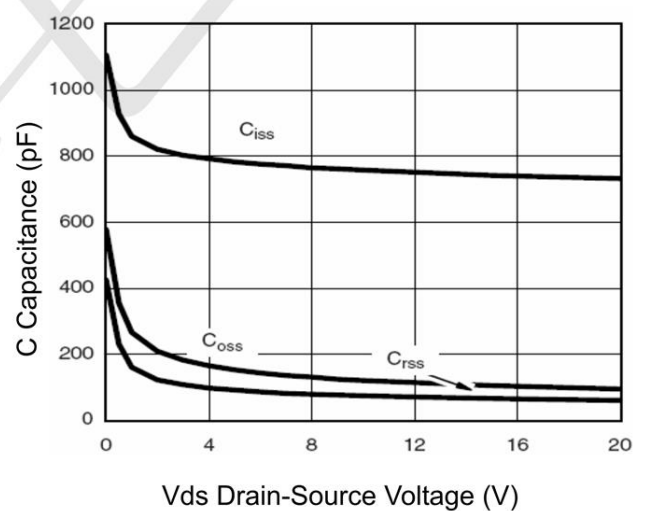

Figure 10 Capacitance vs Vds

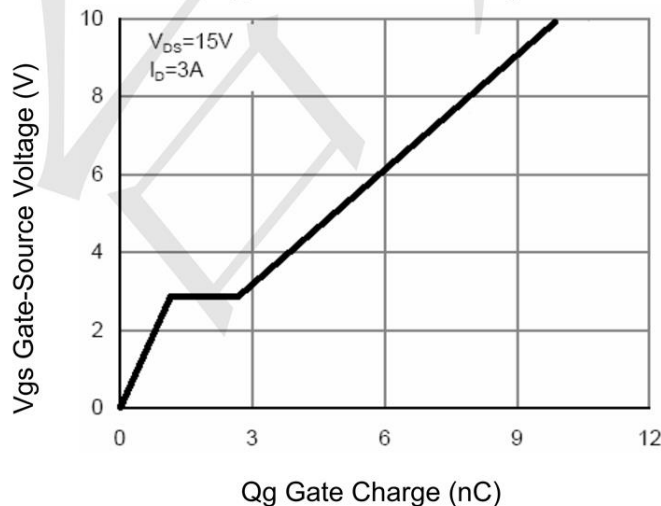

Figure 11 Gate Charge

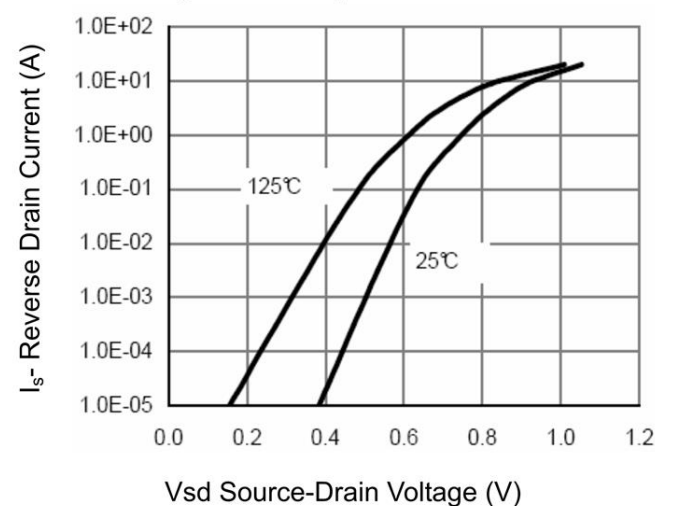

Figure 12 Source- Drain Diode Forward

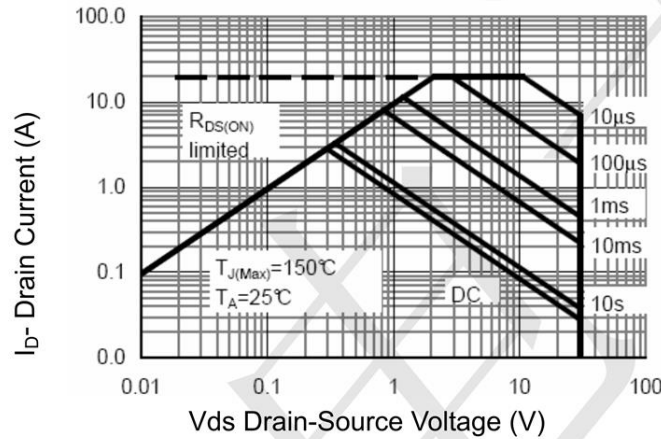

Figure 13 Safe Operation Area

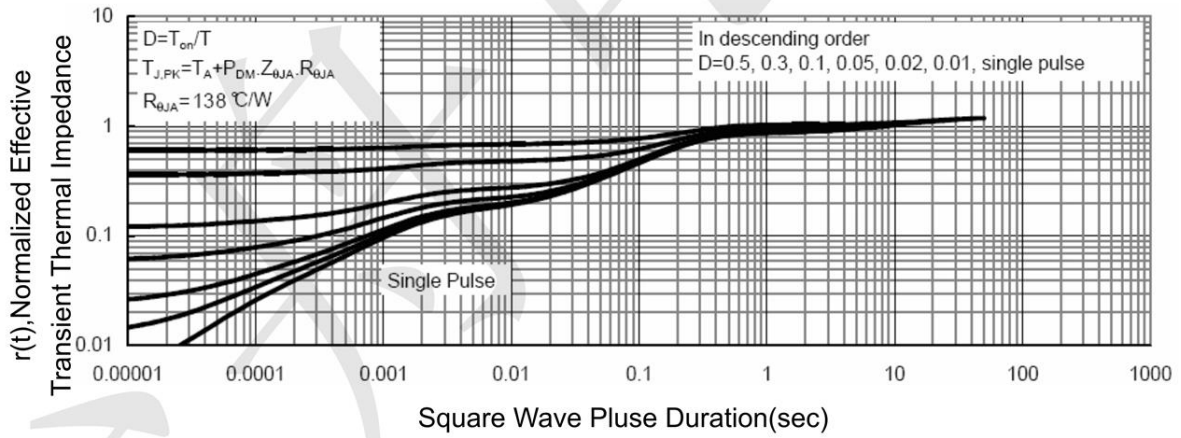
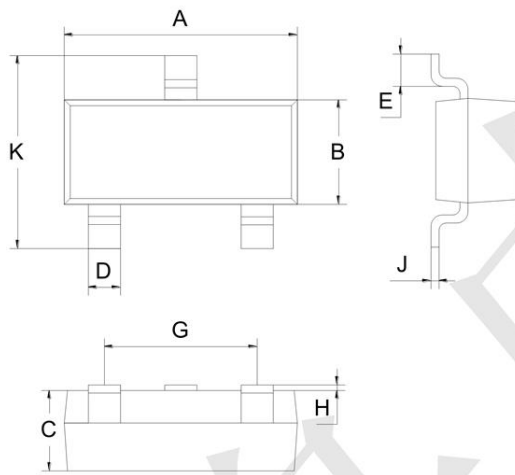

Figure 14 Normalized Maximum Transient Thermal Impedance

Outline Drawing - SOT23



SOT-23		
Dimension	Min.	Max.
A	2.70	3.10
B	1.10	1.50
C	0.90	1.10
D	0.30	0.50
E	0.35	0.48
G	1.80	2.00
H	0.02	0.10
J	0.05	0.15
K	2.20	2.60

Land Pattern - SOT23

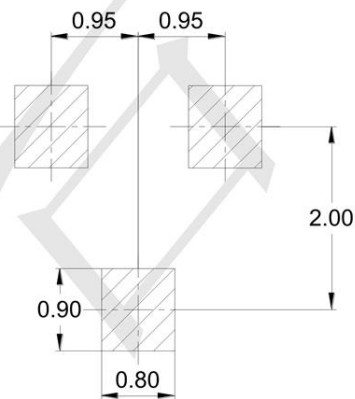

X-ON Electronics

Largest Supplier of Electrical and Electronic Components

Click to view similar products for [MOSFET](#) category:

Click to view products by [TECH PUBLIC](#) manufacturer:

Other Similar products are found below :

[IRFD120](#) [JANTX2N5237](#) [BUK455-60A/B](#) [MIC4420CM-TR](#) [VN1206L](#) [NDP4060](#) [SI4482DY](#) [IPS70R2K0CEAKMA1](#) [SQD23N06-31L-GE3](#)
[TK16J60W,S1VQ\(O](#) [2SK2614\(TE16L1,Q\)](#) [DMN1017UCP3-7](#) [DMN1053UCP4-7](#) [SQJ469EP-T1-GE3](#) [NTE2384](#) [DMC2700UDMQ-7](#)
[DMN2080UCB4-7](#) [DMN61D9UWQ-13](#) [US6M2GTR](#) [DMN31D5UDJ-7](#) [DMP22D4UFO-7B](#) [DMN1006UCA6-7](#) [DMN16M9UCA6-7](#)
[STF5N65M6](#) [IRF40H233XTMA1](#) [STU5N65M6](#) [DMN6022SSD-13](#) [DMN13M9UCA6-7](#) [DMTH10H4M6SPS-13](#) [DMN2990UFB-7B](#)
[IPB80P04P405ATMA2](#) [2N7002W-G](#) [MCAC30N06Y-TP](#) [MCQ7328-TP](#) [BXP7N65D](#) [BXP4N65F](#) [AOL1454G](#) [WMJ80N60C4](#) [BXP2N20L](#)
[BXP2N65D](#) [BXT1150N10J](#) [BXT1700P06M](#) [TSM60NB380CP](#) [ROG](#) [RQ7L055BGTCR](#) [DMNH15H110SK3-13](#) [SLF10N65ABV2](#)
[BSO203SP](#) [BSO211P](#) [IPA60R230P6](#) [IPA60R460CE](#)