

## Features

- Ultra-Low capacitance:0.05pF(typ.)
- Low leakage current(<10nA)
- Fast response time(<1ns)
- Bi-directional,single line protection
- IEC 61000-4-2 (ESD Air): 15kV  
IEC 61000-4-2 (ESD Contact): 8kV

## Mechanical Characteristics

- USB 3.0/3.1
- HDMI 1.3/1.4/2.0
- RF Antenna
- SATA and eSATA Interface

## Applications

- Smart Phone/Mobile Internet Device
- Laptop/Desktop Computer
- Bi-directional, single line protection
- Antennas (Cell Phones, GPS...)
- High Speed Ethernet
- USB 3.0 and USB 3.1

## Dimensions and Pin Configuration

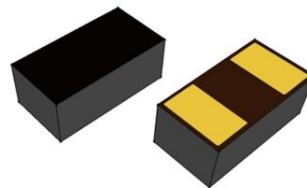
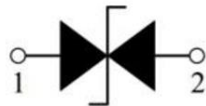

**Absolute Maximum Ratings** (Tamb=25°C unless otherwise specified)

Parameter	Symbol	Value	Unit
ESD per IEC 61000-4-2 (Air) ESD per IEC 61000-4-2 (Contact)	VESD	±15 ±8	kV
Operating Temperature Range	TJ	-55 to +125	°C
Storage Temperature Range	Tstg	-40 to +85	°C

**Electrical Characteristics** (TA=25°C unless otherwise specified)

Parameter	Symbol	Min	Typ	Max	Unit	Test Condition
Continuous Operating Voltage	V <sub>DC</sub>			14	V	
Trigger Voltage	V <sub>T</sub>		450		V	IEC61000-4-2 8kV contact discharge
Clamping Voltage	V <sub>C</sub>		40		V	IEC61000-4-2 8kV contact discharge
Leakage Current	I <sub>L</sub>			10	nA	DC 14V shall be applied on component
Capacitance	C <sub>J</sub>		0.05		pF	Measured at 10MHz

**PROTECTION PRODUCTS**  
Typical characteristics

**HDMI Mask at 3.4 Gbps**

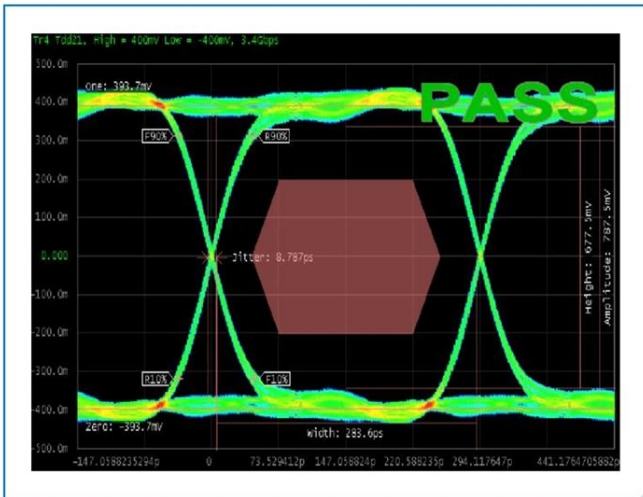

**USB3.0 Mask at 5.0 Gbps**

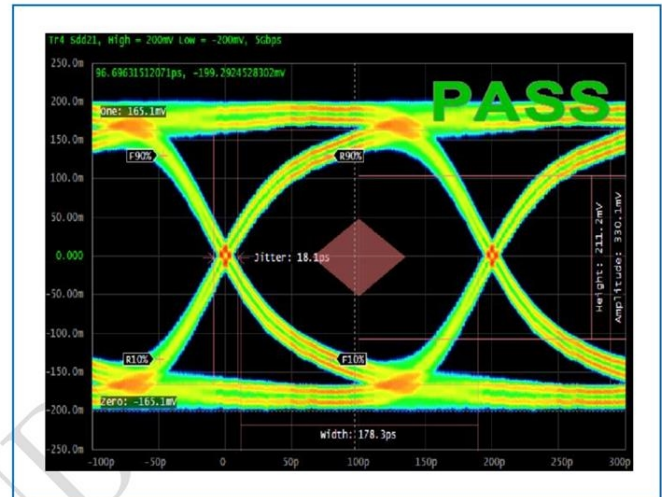

**ESD Protection for Signal Line**

The PESD0402-140 is designed for the protection of one bidirectional data line from ESD damage.

- Place the PESD0402-140 as close to the input terminal or connector as possible .
- Minimize the path length between the PESD0402-140 and the protected signal line.
- Use ground planes whenever possible.

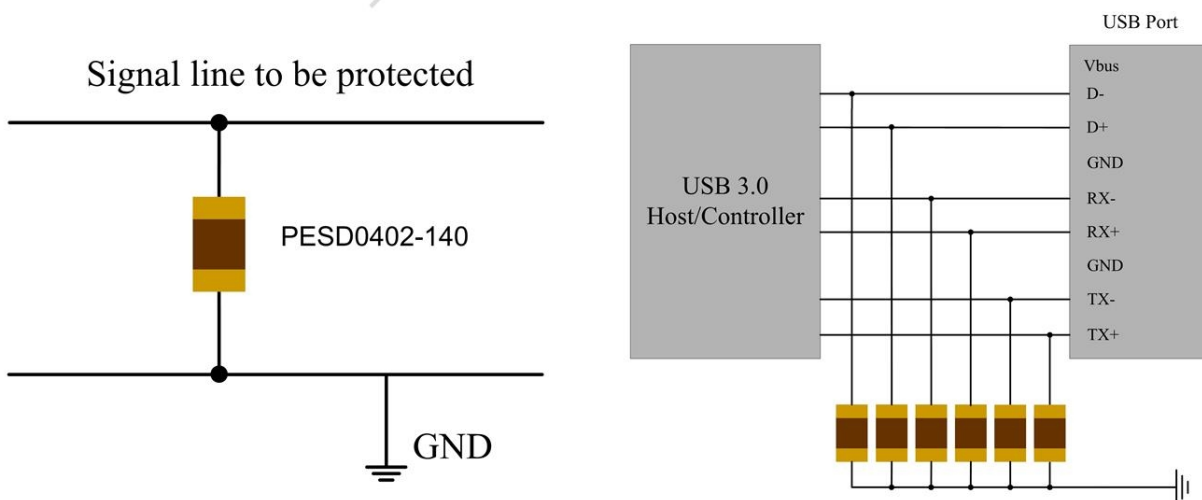

**Package Dimension**

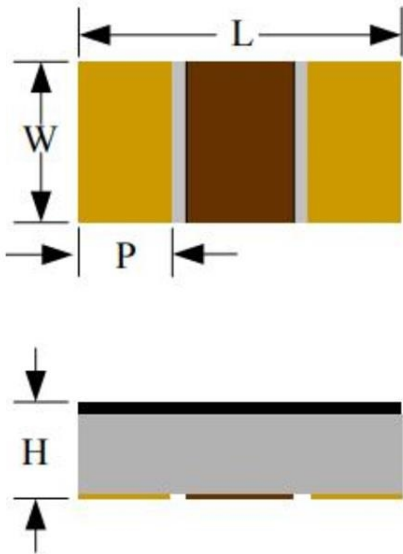

**Recommended Solder Pad Footprint**

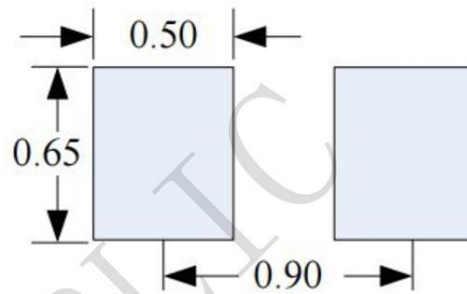

**\*Sizes in mm**

Notes:

This solder pad layout is for reference purposes only.

Dimension	Unit: Millimeters	
	Min.	Max.
L	0.90	1.10
W	0.42	0.62
p	0.15	0.35
H	0.25	0.45

## X-ON Electronics

Largest Supplier of Electrical and Electronic Components

*Click to view similar products for [ESD Suppressors / TVS Diodes](#) category:*

*Click to view products by [TECH PUBLIC](#) manufacturer:*

Other Similar products are found below :

[60KS200C](#) [D18V0L1B2LP-7B](#) [D5V0F4U5P5-7](#) [NTE4902](#) [P4KE27CA](#) [P6KE11CA](#) [P6KE8.2A](#) [SA60CA](#) [SA64CA](#) [SMBJ12CATR](#)  
[SMBJ33CATR](#) [SMBJ6.5A](#) [SMBJ8.0A](#) [ESD101-B1-02ELS E6327](#) [ESD112-B1-02EL E6327](#) [ESD7451N2T5G](#) [19180-510](#) [CPDT-5V0USP-](#)  
[HF](#) [3.0SMCJ33CA-F](#) [3.0SMCJ36A-F](#) [HSPC16701B02TP](#) [JANTX1N6126A](#) [D3V3Q1B2DLP3-7](#) [D55V0M1B2WS-7](#) [SCM1293A-04SO](#)  
[ESD200-B1-CSP0201 E6327](#) [SM12-7](#) [CEN955 W/DATA](#) [VESD12A1A-HD1-GS08](#) [CPDQC5V0-HF](#) [D1213A-01LP4-7B](#) [ESD101-B1-02EL](#)  
[E6327](#) [AOZ8808DI-03](#) [5KP15A](#) [5KP48A](#) [5KP90A](#) [ESD3V3D7-TP](#) [15KPA36A-LF](#) [P4KE56CA](#) [P4KE68A](#) [P4KE91CATR](#) [P6KE120A](#)  
[P6KE13CA](#) [P6KE43CA](#) [P6KE6.8CA](#) [P6KE8.2](#) [P6SMBJ20CA](#) [JANTX1N6072A](#) [SR2835ESKG](#) [SA90CA](#)