

### Features

- 150 Watts peak pulse power ( $t_p = 8/20\mu s$ )
- Transient protection for high speed data lines to
- IEC 61000-4-2 (ESD)  $\pm 30kV$  (air),  $\pm 30kV$  (contact)
- IEC 61000-4-4 (EFT) 40A(5/50ns)
- Protects One Power or I/O Port
- Low leakage current
- Low operating and clamping voltages
- Solid-state silicon avalanche technology

### Mechanical Characteristics

- Package: SOD-523
- Lead Finish: Matte Tin
- Case Material: "Green" Molding Compound.
- UL Flammability Classification Rating 94V-0
- Moisture Sensitivity: Level 3 per J-STD-020
- Terminal Connections: See Diagram Below

### Applications

- Cellular Handsets and Accessories
- Personal Digital Assistants
- Notebooks and Handhelds
- Portable Instrumentation
- Digital Cameras
- Peripherals
- Audio Players
- Keypads, Side Keys, LCD Displays, USB2.0

### Ordering Information

Part Number	Qty per Reel	Reel Size
PESD5Z3.3	3000	7"

### Dimensions and Pin Configuration

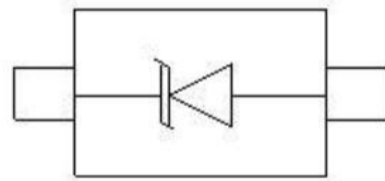

SOD-523 (Top View)

**Absolute Maximum Ratings ( $T_A=25^\circ\text{C}$  unless otherwise specified)**

Parameter	Symbol	Value	Unit
ESD per IEC 61000-4-2 (Air)	VESD	±30	kV
ESD per IEC 61000-4-2 (Contact)		±30	
Operating Temperature Range	TJ	-55 to +125	°C
Storage Temperature Range	Tstg	-55 to +150	°C

**Electrical Characteristics ( $T_A=25^\circ\text{C}$  unless otherwise specified)**

Symbol	Parameter
$I_{PP}$	Maximum Reverse Peak Pulse Current
$V_C$	Clamping Voltage @ $I_{PP}$
$V_{RWM}$	Working Peak Reverse Voltage
$I_R$	Maximum Reverse Leakage Current @ $V_{RWM}$
$V_{BR}$	Breakdown Voltage @ $I_T$
$I_T$	Test Current
$I_F$	Forward Current
$V_F$	Forward Voltage @ $I_F$
$P_{pk}$	Peak Power Dissipation
C	Capacitance @ $V_R = 0$ and $f = 1.0$ MHz

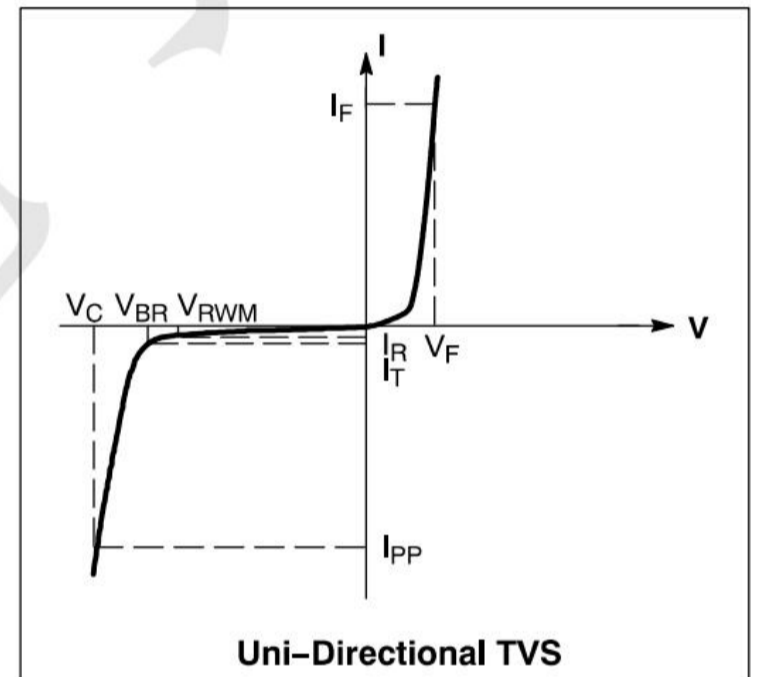

Parameter	Symbol	Min	Typ	Max	Unit	Test Condition
Reverse Working Voltage	$V_{RWM}$			3.3	V	
Breakdown Voltage	$V_{BR}$	5			V	$I_T = 1\text{mA}$
Reverse Leakage Current	$I_R$			0.2	uA	$V_{RWM} = 5\text{V}$
Clamping Voltage	$V_C$			9	V	$I_{PP} = 1\text{A}$ (8 x 20µs pulse)
Clamping Voltage	$V_C$			14	V	$I_{PP} = 11\text{A}$ (8 x 20µs pulse)
Junction Capacitance	CJ			110	pF	$V_R = 0\text{V}$ , $f = 1\text{MHz}$

## Characteristic Curves

**Fig1. 8/20 $\mu$ s Pulse Waveform**

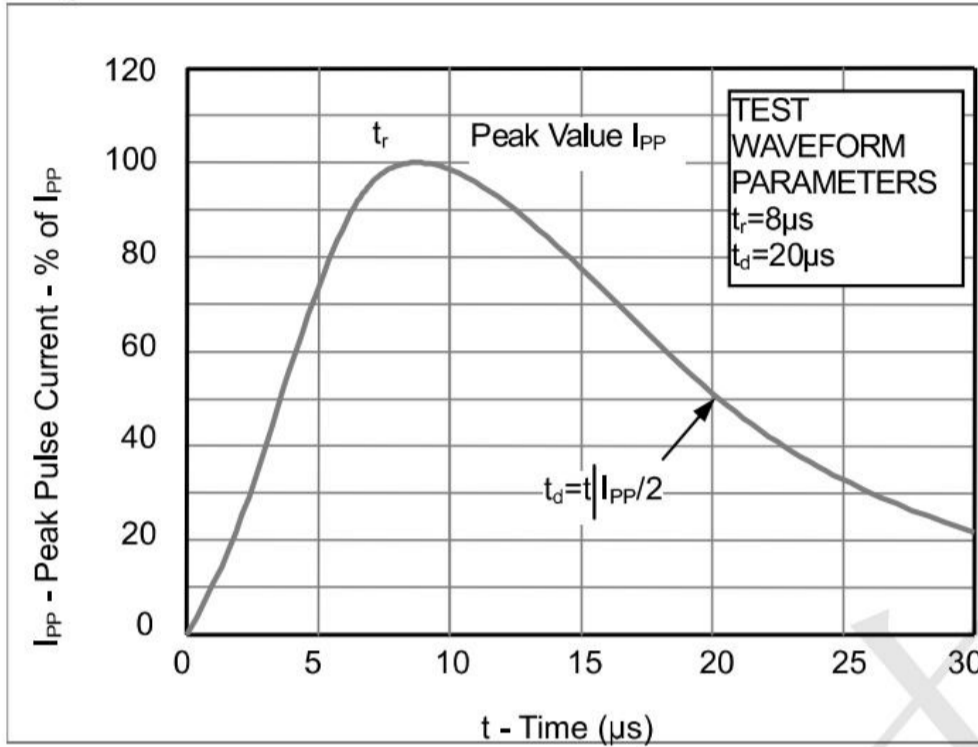

**Fig2. ESD Pulse Waveform (according to IEC 61000-4-2)**

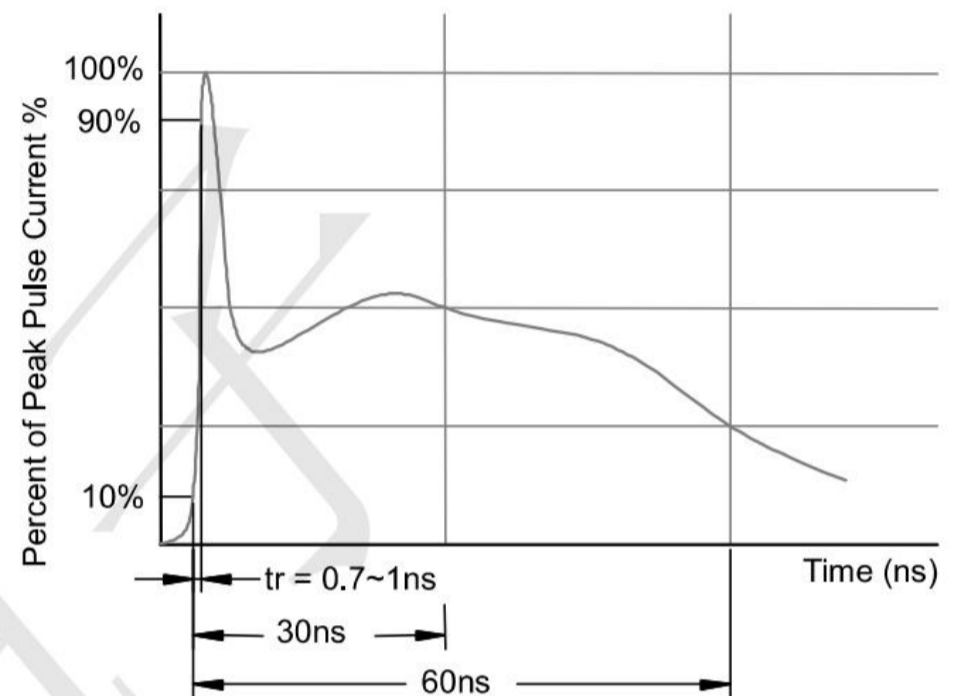

**Fig3. Power Derating Curve**

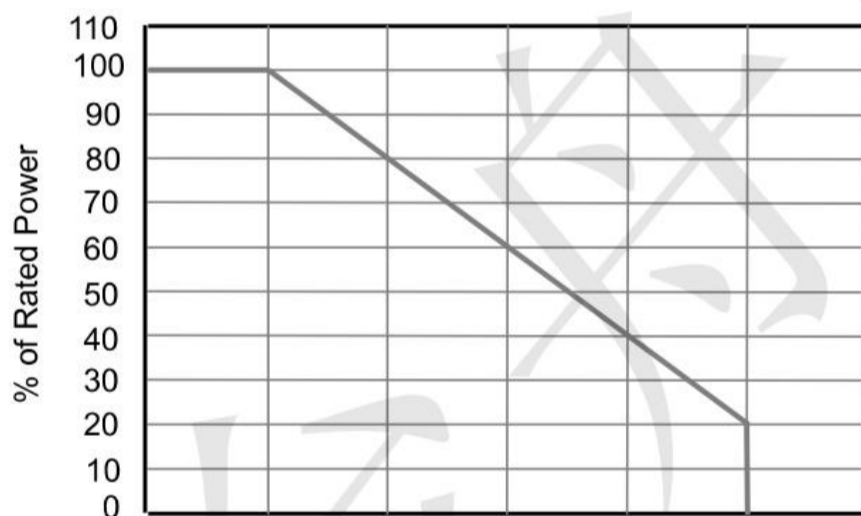

**SOD-523 Package Outline Drawing**

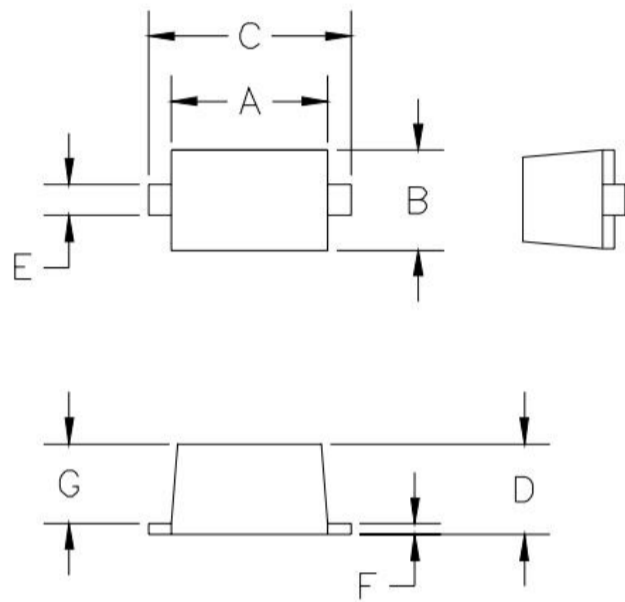

DIM <sup>N</sup>	INCHES		MM [1]		NOTE
	MIN	MAX	MIN	MAX	
A	.043	.051	1.10	1.30	—
B	.028	.035	0.70	0.90	—
C	.059	.067	1.50	1.70	—
D	.020	.028	0.50	0.70	—
E	.010	.014	0.25	0.35	—
F	.004	.008	0.10	0.20	—
G	.020	.028	0.50	0.70	—

[1] CONTROLLING DIMENSION: MILLIMETERS

**Suggested Land Pattern**

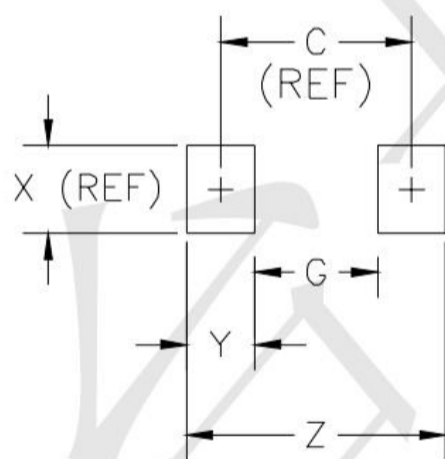

DIM <sup>N</sup>	INCHES		MM [1]		NOTE
	MIN	MAX	MIN	MAX	
C	—	.067	—	1.70	REF
G	—	.043	—	1.10	—
X	—	.031	—	0.80	REF
Y	—	.024	—	0.60	—
Z	—	.091	—	2.30	—

[1] CONTROLLING DIMENSION: MILLIMETERS

## X-ON Electronics

Largest Supplier of Electrical and Electronic Components

*Click to view similar products for [ESD Suppressors / TVS Diodes](#) category:*

*Click to view products by [TECH PUBLIC](#) manufacturer:*

Other Similar products are found below :

[60KS200C](#) [D18V0L1B2LP-7B](#) [D5V0F4U5P5-7](#) [DESD5V0U1BB-7](#) [NTE4902](#) [P4KE27CA](#) [P6KE11CA](#) [P6KE39CA-TP](#) [P6KE8.2A](#)  
[SA110CA](#) [SA60CA](#) [SA64CA](#) [SMBJ12CATR](#) [SMBJ33CATR](#) [SMBJ8.0A](#) [ESD101-B1-02ELS E6327](#) [ESD105-B1-02EL E6327](#) [ESD112-B1-02EL E6327](#) [ESD119B1W01005E6327XTSA1](#) [ESD5V0L1B02VH6327XTSA1](#) [ESD7451N2T5G](#) [19180-510](#) [CPDT-5V0USP-HF](#)  
[3.0SMCJ33CA-F](#) [3.0SMCJ36A-F](#) [HSPC16701B02TP](#) [D3V3Q1B2DLP3-7](#) [D55V0M1B2WS-7](#) [DESD5V0U1BL-7B](#) [DRTR5V0U4SL-7](#)  
[SCM1293A-04SO](#) [ESD200-B1-CSP0201 E6327](#) [SM12-7](#) [SMLJ45CA-TP](#) [CEN955 W/DATA](#) [82350120560](#) [VESD12A1A-HD1-GS08](#)  
[CPDUR5V0R-HF](#) [CPDQC5V0U-HF](#) [CPDQC5V0USP-HF](#) [CPDQC5V0-HF](#) [D1213A-01LP4-7B](#) [D1213A-02WL-7](#) [MMAD1108/TR13](#)  
[5KP100A](#) [5KP15A](#) [5KP18A](#) [5KP48A](#) [5KP90A](#) [5KP90CA](#)