

Features

- 400W peak pulse power (8/20 μ s)
- Ultra low leakage: nA level
- Operating voltage: 7V or 12V
- Low clamping voltage
- Complies with following standards:
 - IEC 61000-4-2 (ESD) immunity test
 - Air discharge: \pm 30kV
 - Contact discharge: \pm 30kV
 - IEC61000-4-4 (EFT) 40A (5/50ns)
 - IEC61000-4-5 (Lightning) 17A (8/20 μ s)
- RoHS Compliant

Ordering Information

Part Number	Qty per Reel	Reel Size
PSM712	3000	7"

Mechanical Characteristics

- Package: SOT-23
- Lead Finish: Matte Tin
- Case Material: "Green" Molding Compound.
- UL Flammability Classification Rating 94V-0
- Moisture Sensitivity: Level 3 per J-STD-020
- Terminal Connections: See Diagram Below
- techpublic electronics

Applications

- Wireless System
- Networks
- Portable Instrumentation
- RS485 Ports

Dimensions and Pin Configuration

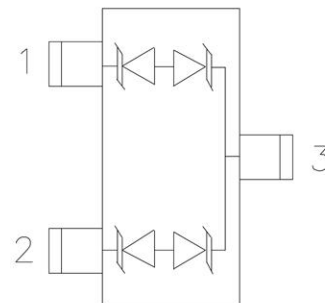
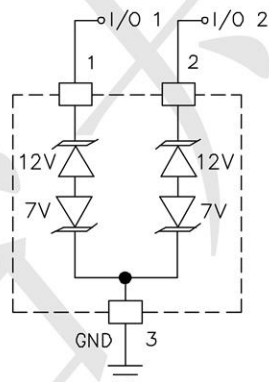

Absolute Maximum Ratings (Tamb=25°C unless otherwise specified)

Parameter	Symbol	Value	Unit
Peak Pulse Power (8/20μs)	Ppk	400	W
Peak Pulse Current (8/20μs)	Ipp	17	A
ESD per IEC 61000-4-2 (Air)	VESD	±30	kV
ESD per IEC 61000-4-2 (Contact)		±30	
Operating Temperature Range	TJ	-55 to +125	°C
Storage Temperature Range	Tstg	-55 to +150	°C

www.sot23.com.tw

Electrical Characteristics (TA=25°C unless otherwise specified)

Parameter	Symbol	Pin 1 to 3 and 2 to 3 (12V TVS)			Pin 3 to 1 and 3 to 2 (7V TVS)			Unit	Test Condition
		Min	Typ	Max	Min	Typ	Max		
Reverse Working Voltage	VRWM			12			7	V	
Breakdown Voltage	VBR	13.3			7.5			V	IT = 1mA
Reverse Leakage Current	IR			0.05			2.0	μA	VR = VRWM
Clamping Voltage	VC			20			10	V	I _{PP} = 5A (8 x 20μs pulse)
Clamping Voltage	VC			26			12	V	I _{PP} = 17A (8 x 20μs pulse)
Junction Capacitance	CJ			75			75	pF	VR = 0V, f = 1MHz
Junction Capacitance	CJ		45			45		pF	VR = VRWM, f = 1MHz

PROTECTION PRODUCTS
Typical characteristics

Fig1. 8/20 μ s Pulse Waveform

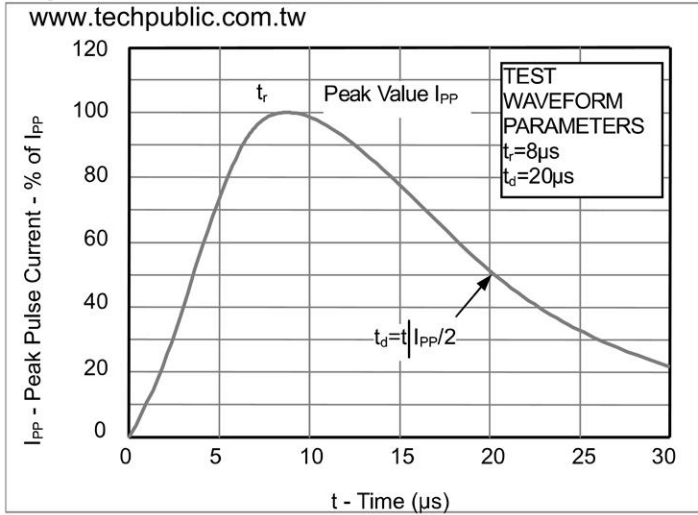

Fig2. ESD Pulse Waveform (according to IEC 61000-4-2)

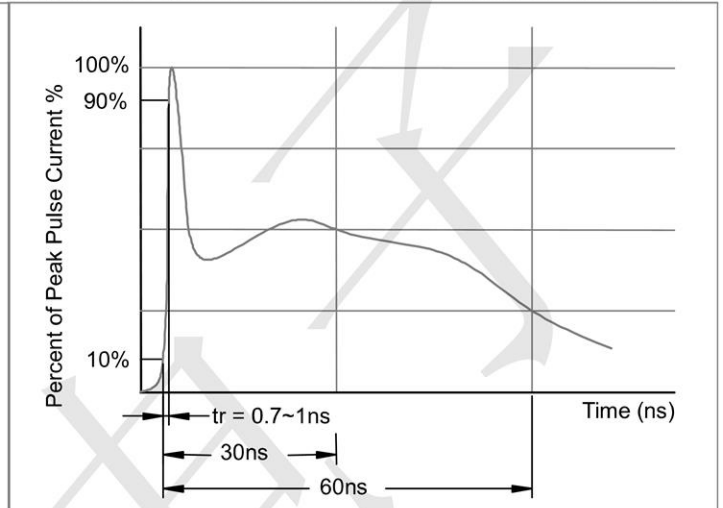
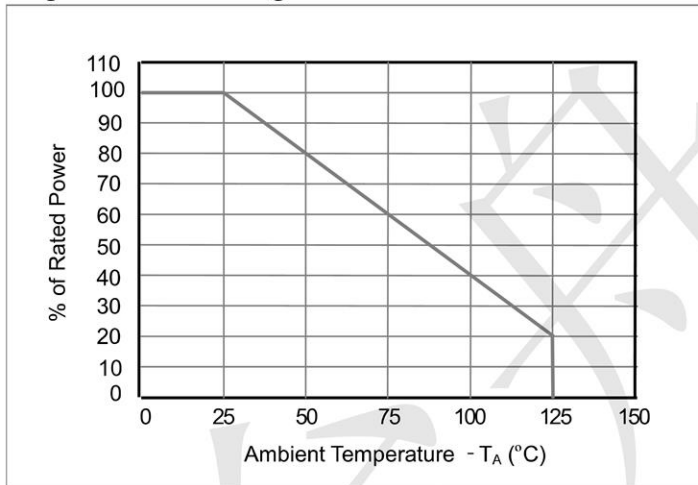
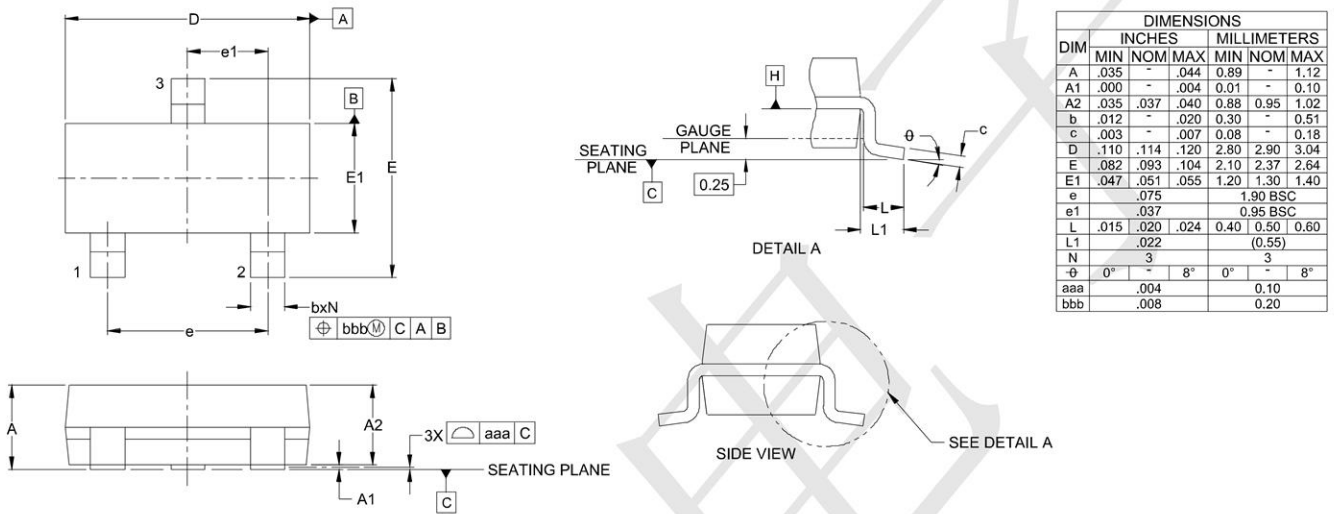

Fig3. Power Derating Curve



Outline Drawing - SOT23



Land Pattern - SOT23

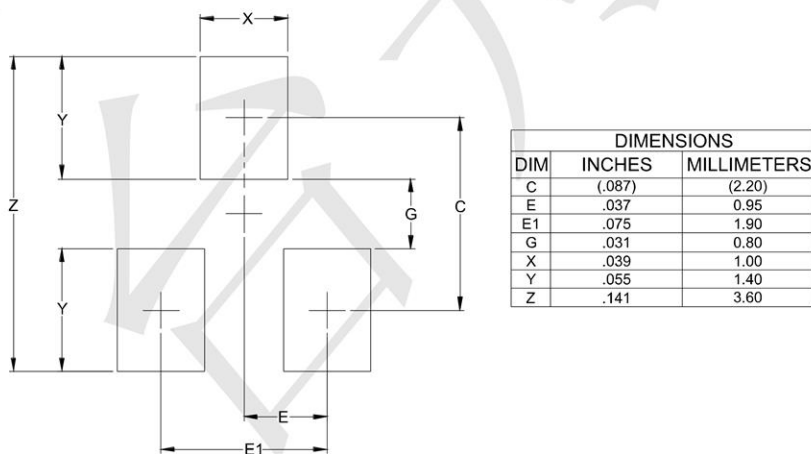

X-ON Electronics

Largest Supplier of Electrical and Electronic Components

Click to view similar products for [ESD Suppressors / TVS Diodes](#) category:

Click to view products by [TECH PUBLIC](#) manufacturer:

Other Similar products are found below :

[60KS200C](#) [D18V0L1B2LP-7B](#) [D5V0F4U5P5-7](#) [DESD5V0U1BB-7](#) [NTE4902](#) [P4KE27CA](#) [P6KE11CA](#) [P6KE39CA-TP](#) [P6KE8.2A](#)
[SA110CA](#) [SA60CA](#) [SA64CA](#) [SMBJ12CATR](#) [SMBJ33CATR](#) [SMBJ8.0A](#) [ESD101-B1-02ELS E6327](#) [ESD105-B1-02EL E6327](#) [ESD112-B1-02EL E6327](#) [ESD119B1W01005E6327XTSA1](#) [ESD5V0L1B02VH6327XTSA1](#) [ESD7451N2T5G](#) [19180-510](#) [CPDT-5V0USP-HF](#)
[3.0SMCJ33CA-F](#) [3.0SMCJ36A-F](#) [HSPC16701B02TP](#) [D3V3Q1B2DLP3-7](#) [D55V0M1B2WS-7](#) [DESD5V0U1BL-7B](#) [DRTR5V0U4SL-7](#)
[SCM1293A-04SO](#) [ESD200-B1-CSP0201 E6327](#) [SM12-7](#) [SMF8.0A-TP](#) [SMLJ45CA-TP](#) [SMQA1000T1G](#) [CEN955 W/DATA](#) [82350120560](#)
[VESD12A1A-HD1-GS08](#) [CPDUR5V0R-HF](#) [CPDQC5V0U-HF](#) [CPDQC5V0USP-HF](#) [CPDQC5V0-HF](#) [IP4042CX5/LF,135](#) [D1213A-01LP4-7B](#) [D1213A-02WL-7](#) [1SMB33CAT3G-XYZ](#) [MMAD1108/TR13](#) [5KP100A](#) [5KP15A](#)