

General Description

The RT9013 is a high-performance, 500mA LDO regulator, offering extremely high PSRR and ultra-low dropout. Ideal for portable RF and wireless applications with demanding performance and space requirements.

The RT9013 is available in 5pin SOT23-5 Package .the output standards of 1.2V 1.5V 1.8V 2.5V 2.8V 3.0V 3.3V

Features

- Quiescent Current: 60uA
- PSRR:75dB@1KHz
- < 1uA current at shutdown mode
- Output voltage accuracy: tolerance $\pm 2\%$
- Output current:500mA(Typ.)
- SOT23-5 package

Applications

- CDM/GSM mobile phone
- PDAs /MP3
- Audio/Video equipment

Ordering Information

RT9013-15GB

GB:SOT23-5 Package

Output voltage: 33=3.3V
50=5.0V
28=2.8V
30=3.0V
XX=X.XV

BLOCK DIAGRAM

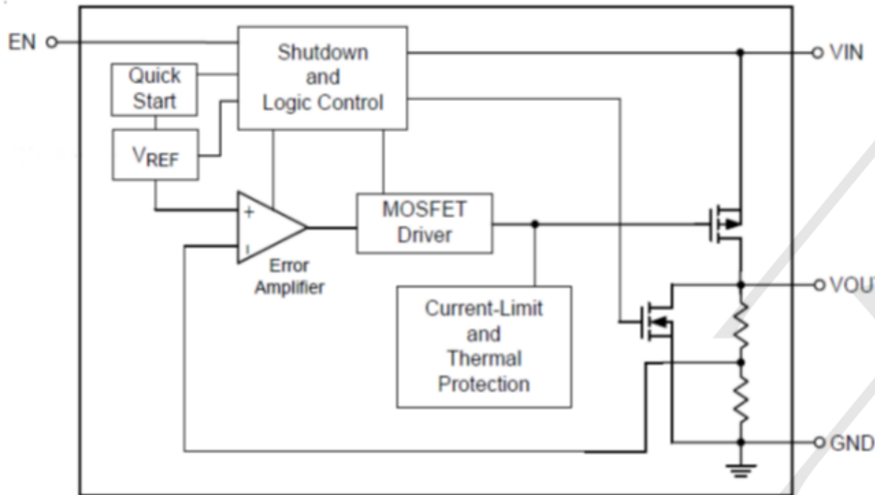

PIN CONFIGURATION

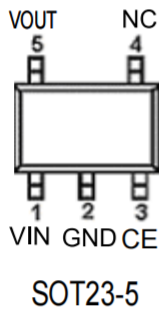

Pin Name	Function
VIN	Supply power
GND	Ground
CE	Enable pin
NC	NC
VOUT	Voltage output

Absolute Maximum Rating (T_A=25°C unless otherwise noted)

Parameter	Symbol	Maximum Rating		Unit
Input Voltage	V _{IN}	7		V
Output Voltage	V _{OUT}	V _{SS} -0.3~V _{IN} +0.3		
Output Current	I _{out}	600		mA
Power Dissipation	P _D	SOT-23-5	250	mW
Operating Ambient Temperature	T _{opr}	-40~+85		
Storage Temperature	T _{stg}	-40~+125		

Electrical Characteristics (T =25°C unless otherwise noted)

(Vin=Vout+1V,Cin=Cout=1uF,Ta=25°C)

PARAMETER	SYMBOL	CONDITIONS	MIN	TYP	MAX	UNITS
Output Voltage	V _{OUT(E)} (Note 2)	I _{OUT} =40mA, V _{IN} =Vout+1V	X 0.98	V _{OUT(T)} (Note 1)	X 1.02	V
Input Voltage	V _{IN}				7.0	V
Max. Output Current	I _{OUTmax}	V _{IN} =Vout+1V		500		mA
CE Enable Voltage	V _{CE}	V _{IN} =Vout+1V		1.1		V
Load Regulation	ΔV _{OUT}	V _{IN} =Vout+1V, 1mA≤I _{OUT} ≤100mA		50		mV
Dropout Voltage (Note 3)	V _{dif1}	I _{OUT} =100mA		100		mV
	V _{dif2}	I _{OUT} =200mA		300		mV
Supply Current	I _{SS}	V _{IN} =Vout+1V		60		μA
Standby Current	I _{CEL}	Vce=0V		1		μA
Line Regulation	$\frac{\Delta V_{OUT}}{\Delta V_{IN} \cdot V_{OUT}}$	I _{OUT} =40mA Vout+1V ≤ V _{IN} ≤ 8V		0.03		%/V
Output Noise	en	I _{OUT} =40mA, 300Hz~50kHz		50		uVrms
Ripple Rejection Rate	PSRR	Vin= [Vout+1]V +1Vp-pAC I _{OUT} =40mA,f=1kHz		70		dB

TYPICAL APPLICATION

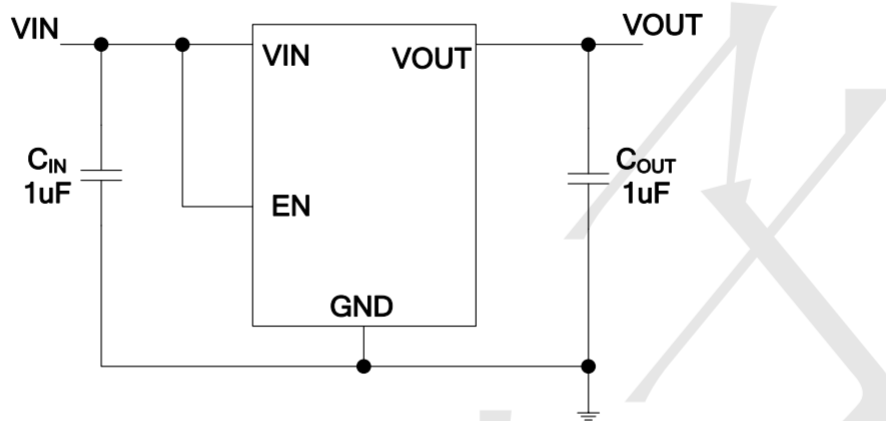

Package informantion

SOT23-5

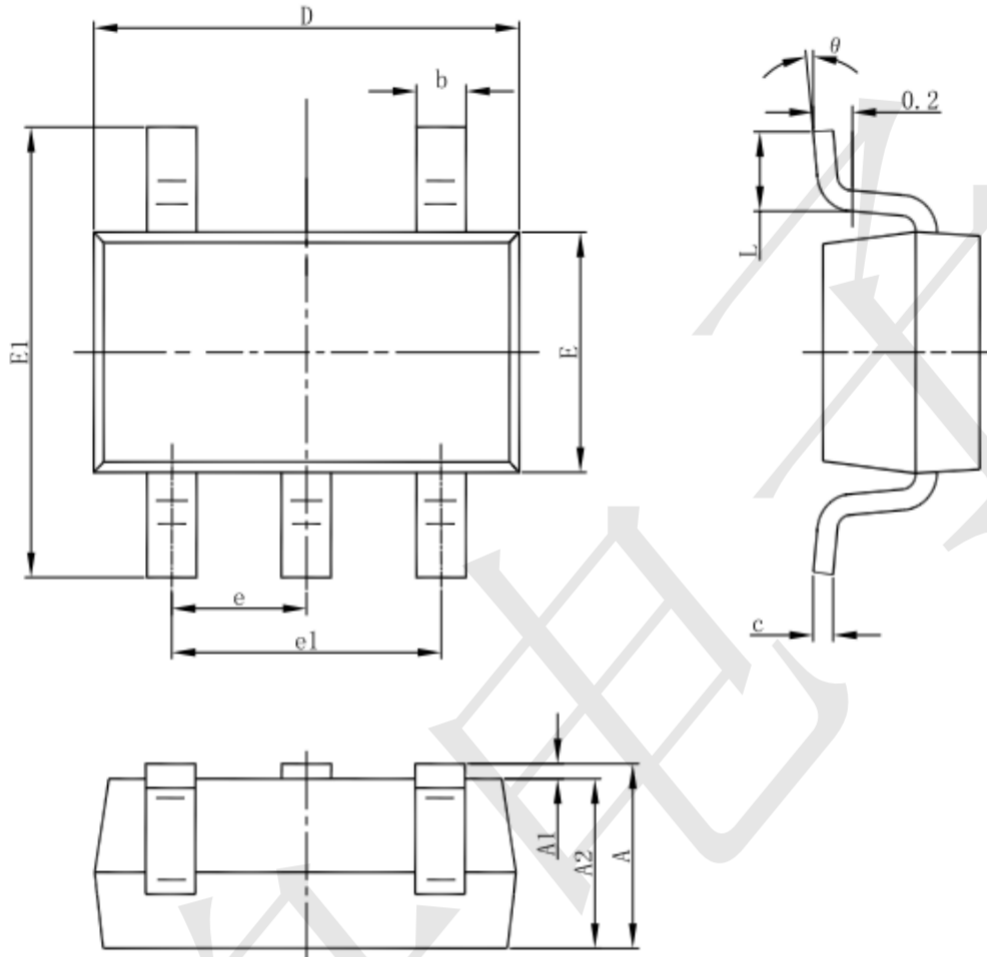

Symbol	Dimensions In Millimeters		Dimensions In Inches	
	Min	Max	Min	Max
A	1.050	1.250	0.041	0.049
A1	0.000	0.100	0.000	0.004
A2	1.050	1.150	0.041	0.045
b	0.300	0.500	0.012	0.020
c	0.100	0.200	0.004	0.008
D	2.820	3.020	0.111	0.119
E	1.500	1.700	0.059	0.067
E1	2.650	2.950	0.104	0.116
e	0.950(BSC)		0.037(BSC)	
e1	1.800	2.000	0.071	0.079
L	0.300	0.600	0.012	0.024
θ	0°	8°	0°	8°

X-ON Electronics

Largest Supplier of Electrical and Electronic Components

Click to view similar products for [Linear Voltage Regulators](#) category:

Click to view products by [TECH PUBLIC](#) manufacturer:

Other Similar products are found below :

[LV5684PVD-XH](#) [MCDTSA6-2R](#) [L7815ACV-DG](#) [714954EB](#) [ZMR500QFTA](#) [BA033LBSG2-TR](#) [LV5680P-E](#) [L79M05T-E](#) [L78LR05D-MA-E](#) [NCV317MBTG](#) [NTE7227](#) [MP2018GZD-33-P](#) [MP2018GZD-5-P](#) [LV5680NPVC-XH](#) [LT1054CN8](#) [UA78L09CLP](#) [UA78L09CLPR](#) [CAT6221-PPTD-GT3](#) [MC78M09CDTRK](#) [NCV51190MNTAG](#) [78M05](#) [HT7150-1](#) [UM1540DB-18](#) [XC6234H281VR-G](#) [WL2834CA-6/TR](#) [TPL730F33-5TR](#) [TLS850F1TA](#) [V50](#) [TPS549B22RVFR](#) [UM1540DB-33](#) [WL9200P3-50B](#) [WL9100P3-33B](#) [XC6219B152MR](#) [WL2855K33-3/TR](#) [PJ54BM33SE](#) [PJ9500M25SA](#) [MD7218E33PC1](#) [H7533-2PR](#) [SK7812AU](#) [SD1A30](#) [78L33](#) [TP78L33T3](#) [SK6513ST3A-50](#) [SK6054D4-09](#) [SK6054D4-18](#) [SK6054D4-11](#) [SK6054D4-10](#) [LM79L12F](#) [HLP2985AIM5X-5.0](#) [HLP2992AIM5X-5.0/NOPB](#) [HMIC5205-5.0YM5-TR](#)