

## Features

- \* 450W peak pulse power (8/20 $\mu$ s)
- \* Protects one data or power line
- \* Ultra low leakage: nA level
- \* Operating voltage: 5V
- \* Ultra low clamping voltage
- \* Complies with following standards:
  - IEC 61000-4-2 (ESD) immunity test
    - Air discharge:  $\pm 30$ kV
    - Contact discharge:  $\pm 30$ kV
  - IEC61000-4-4 (Lightning) 34A (8/20ns)

## Mechanical Characteristics

- \* Package: SOD-323
- \* Lead Finish: Matte Tin
- \* Case Material: "Green" Molding Compound.
- \* UL Flammability Classification Rating 94V-0
- \* Moisture Sensitivity: Level 3 per J-STD-020
- \* Terminal Connections: See Diagram Below

## Applications

- \* Cellular Handsets and Accessories
- \* Personal Digital Assistants
- \* Notebooks and Handhelds
- \* Portable Instrumentation
- \* Peripherals
- \* Pagers Peripherals
- \* Desktop and Servers

## Ordering Information

Part Number	Qty per Reel	Reel Size
SD05C-01FTG	3000	7"

## Dimensions and Pin Configuration

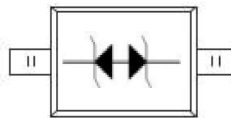

### MARKING



**Absolute Maximum Ratings** (Tamb=25°C unless otherwise specified)

Parameter	Symbol	Value	Unit
Peak Pulse Power (8/20μs)	Ppk	450	W
Peak Pulse Current (8/20μs)	IPP	34	A
ESD per IEC 61000-4-2 (Air)	VESD	±30	kV
ESD per IEC 61000-4-2 (Contact)		±30	
Operating Temperature Range	TJ	-55 to +125	°C
Storage Temperature Range	Tstg	-55 to +150	°C

**Electrical Characteristics** (TA=25°C unless otherwise specified)

Symbol	Parameter
V <sub>RWM</sub>	Nominal Reverse Working Voltage
I <sub>R</sub>	Reverse Leakage Current @ V <sub>RWM</sub>
V <sub>BR</sub>	Reverse Breakdown Voltage @ I <sub>T</sub>
I <sub>T</sub>	Test Current for Reverse Breakdown
V <sub>C</sub>	Clamping Voltage @ I <sub>PP</sub>
I <sub>PP</sub>	Maximum Peak Pulse Current
C <sub>ESD</sub>	Parasitic Capacitance
V <sub>R</sub>	Reverse Voltage
f	Small Signal Frequency

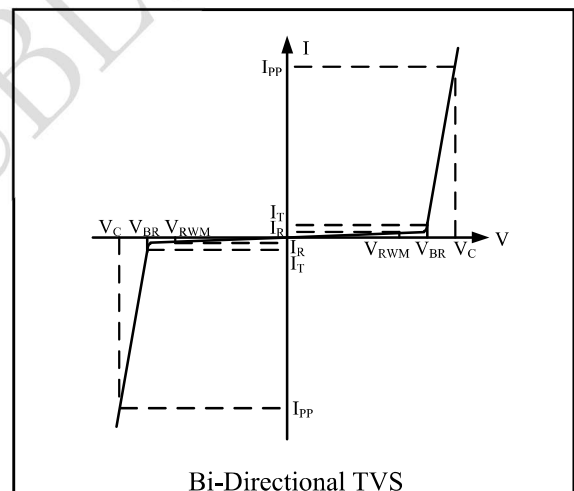

Parameter	Symbol	Test Condition	Min	Typ	Max	Unit
Reverse Working Voltage	V <sub>RWM</sub>				5	V
Breakdown Voltage	V <sub>BR</sub>	I <sub>T</sub> = 1mA(Pin1-Pin2)	6.0	7.0	8.0	V
Reverse Leakage Current	I <sub>R</sub>	V <sub>RWM</sub> = 5.0V(Pin2-Pin1)			0.5	μA
Clamping Voltage	V <sub>C</sub>	I <sub>PP</sub> = 10A (8 x 20μs pulse) (Pin1-Pin2)		9.0	11.0	V
Clamping Voltage	V <sub>C</sub>	I <sub>PP</sub> = 30A (8 x 20μs pulse) (Pin1-Pin2)		12.0	15.0	V
Junction Capacitance	C <sub>J</sub>	V <sub>R</sub> = 0V, f = 1MHz (Pin1-Pin2)		60	100	pF

**Electrical Characteristics (  $T_A = 25^\circ\text{C}$  unless otherwise noted )**

**Fig1. 8/20 $\mu\text{s}$  Pulse Waveform**

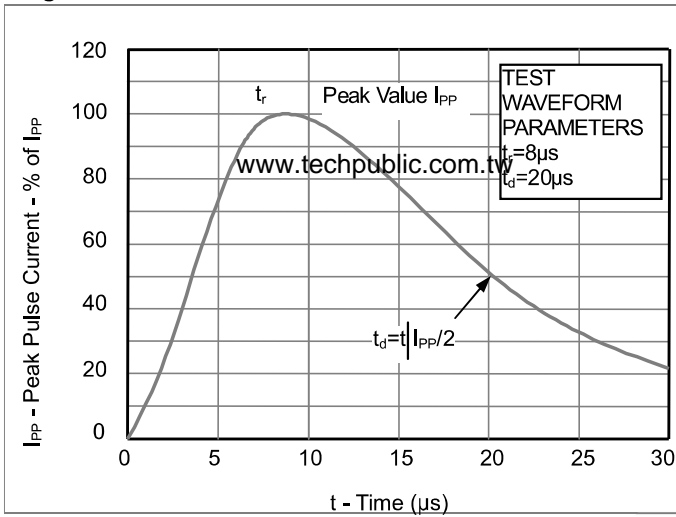

**Fig2. ESD Pulse Waveform (according to IEC 61000-4-2)**

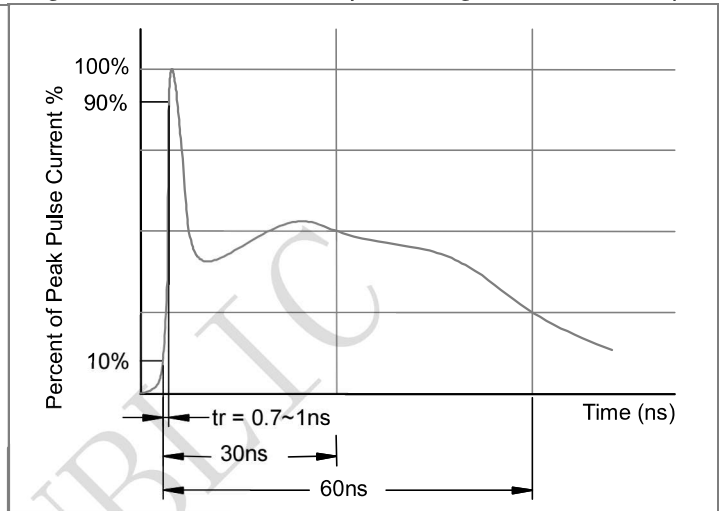

**Fig3. Power Derating Curve**

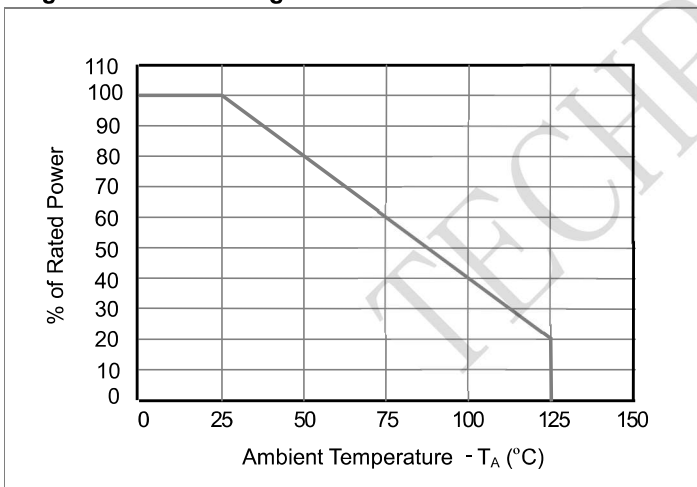

### Outline Drawing - SOD-323

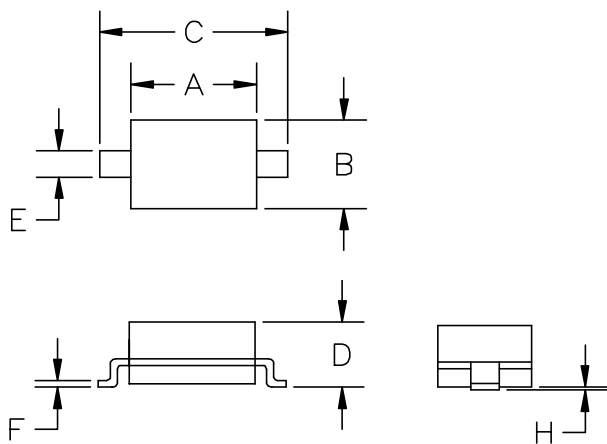

SYM	DIMENSIONS			
	MILLIMETERS		INCHES	
	MIN	MAX	MIN	MAX
A	1.50	1.80	0.060	0.071
B	1.20	1.40	0.045	0.054
C	2.30	2.70	0.090	0.107
D	-	1.10	-	0.043
E	0.30	0.40	0.012	0.016
F	0.10	0.25	0.004	0.010
H	-	0.10	-	0.004

### Land Pattern - SOD-323

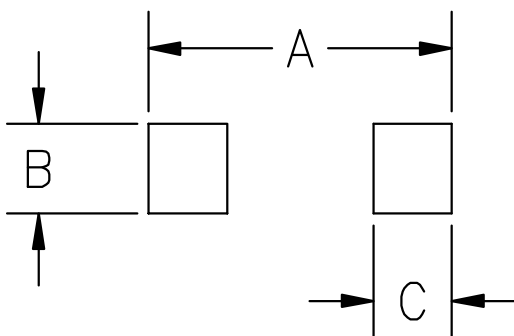

SYM	DIMENSIONS	
	MILLIMETERS	INCHES
A	3.15	0.120
B	0.80	0.031
C	0.80	0.031

## X-ON Electronics

Largest Supplier of Electrical and Electronic Components

*Click to view similar products for [ESD Suppressors / TVS Diodes](#) category:*

*Click to view products by [TECH PUBLIC](#) manufacturer:*

Other Similar products are found below :

[60KS200C](#) [D18V0L1B2LP-7B](#) [D5V0F4U5P5-7](#) [DESD5V0U1BB-7](#) [NTE4902](#) [P4KE27CA](#) [P6KE11CA](#) [P6KE39CA-TP](#) [P6KE8.2A](#)  
[SA110CA](#) [SA60CA](#) [SA64CA](#) [SMBJ12CATR](#) [SMBJ33CATR](#) [SMBJ8.0A](#) [ESD101-B1-02ELS E6327](#) [ESD105-B1-02EL E6327](#) [ESD112-B1-02EL E6327](#) [ESD119B1W01005E6327XTSA1](#) [ESD5V0L1B02VH6327XTSA1](#) [ESD7451N2T5G](#) [19180-510](#) [CPDT-5V0USP-HF](#)  
[3.0SMCJ33CA-F](#) [3.0SMCJ36A-F](#) [HSPC16701B02TP](#) [D3V3Q1B2DLP3-7](#) [D55V0M1B2WS-7](#) [DESD5V0U1BL-7B](#) [DRTR5V0U4SL-7](#)  
[SCM1293A-04SO](#) [ESD200-B1-CSP0201 E6327](#) [SM12-7](#) [SMF8.0A-TP](#) [SMLJ45CA-TP](#) [SMQA1000T1G](#) [CEN955 W/DATA](#) [82350120560](#)  
[VESD12A1A-HD1-GS08](#) [CPDUR5V0R-HF](#) [CPDQC5V0U-HF](#) [CPDQC5V0USP-HF](#) [CPDQC5V0-HF](#) [IP4042CX5/LF,135](#) [D1213A-01LP4-7B](#) [D1213A-02WL-7](#) [1SMB33CAT3G-XYZ](#) [MMAD1108/TR13](#) [5KP100A](#) [5KP15A](#)