

SI1304BDL-T1-GE3 pin to pin fully compatible

Features

BV_{DSS}	30V
$R_{DS(ON)}$	450mΩ
I_D	800mA

Package and Pin Configuration



SOT323

Marking:KFT

Application

- Load/Power Switching
- Interfacing Switching
- Battery Management for Ultra Small Portable Electronics
- Logic Level Shift

Circuit diagram

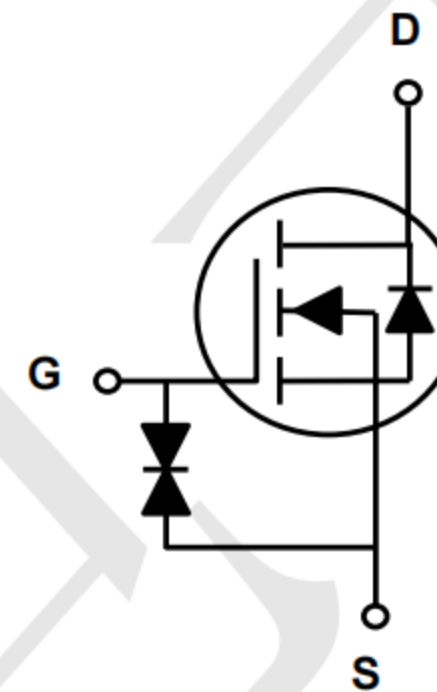

Absolute Maximum Ratings ($T_A=25^\circ\text{C}$ unless otherwise noted)

Parameter	Symbol	Max.	Unit
Drain-Source Voltage	V_{DS}	30	V
Gate-Source Voltage	V_{GS}	±12	V
Drain Current-Continuous($T_C=25^\circ\text{C}$)	I_D	800	mA
Drain Current-Pulsed ¹	I_{DM}	2100	mA
Power Dissipation($T_C=25^\circ\text{C}$)	P_D	360	mW
Power Dissipation-Derate Above 25°C		1.25	mW/°C
Storage Temperature Range	T_{STG}	-55 To +150	°C
Operating Junction Temperature Range	T_J	-55 To +150	°C

Electrical Characteristics ($T_A = 25^\circ\text{C}$ unless otherwise noted)

Parameter	Symbol	Conditions	Min.	Typ.	Max.	Unit
Off Characteristics						
Drain-Source Breakdown Voltage	BV_{DSS}	$V_{GS}=0V, I_D=250\mu A$	30	-	-	V
BV_{DSS} Temperature Coefficient	$\Delta BV_{DSS}/\Delta T_J$	Reference to 25°C , $I_D=1mA$	-	-0.03	-	$V/^\circ\text{C}$
Drain-Source Leakage Current	I_{DSS}	$V_{DS}=30V, V_{GS}=0V,$ $T_J=25^\circ\text{C}$	-	-	1	μA
		$V_{DS}=24V, V_{GS}=0V,$ $T_J=125^\circ\text{C}$	-	-	10	μA
Gate-Source Leakage Current	I_{GSS}	$V_{GS}=\pm 12V, V_{DS}=0V$	-	-	± 20	μA
On Characteristics						
Static Drain-Source On-Resistance	$R_{DS(ON)}$	$V_{GS}=4.5V, I_D=0.5A$	-	350	450	m Ω
		$V_{GS}=2.5V, I_D=0.5A$	-	450	650	
Gate Threshold Voltage	$V_{GS(th)}$	$V_{DS}=V_{GS}, I_D=250\mu A$	0.5	0.8	1.2	V
$V_{GS(th)}$ Temperature Coefficient	$\Delta V_{GS(th)}$		-	-1.74	-	$mV/^\circ\text{C}$
Forward Transconductance	g_{FS}	$V_{DS}=4V, I_D=0.3A$	-	1	-	S
Dynamic and Switching Characteristics						
Total Gate Charge ^{2,3}	Q_g	$V_{DS}=15V, I_D=0.3A,$ $V_{GS}=4.5V$	-	2.6	5.2	nC
Gate-Source Charge ^{2,3}	Q_{gs}		-	0.9	1.8	
Gate-Drain Charge ^{2,3}	Q_{gd}		-	0.6	1.2	
Turn-On Delay Time ^{2,3}	$t_{d(on)}$	$V_{DD}=15V, R_G=10\Omega$ $V_{GS}=4.5V, I_D=0.3A$	-	5.5	11	nS
Rise Time ^{2,3}	t_r		-	4	8	
Turn-Off Delay Time ^{2,3}	$t_{d(off)}$		-	14.5	29	
Fall Time ^{2,3}	t_f		-	6.5	13	
Input Capacitance	C_{iss}	$V_{DS}=15V, V_{GS}=0V,$ $F=1MHz$	-	72.9	146	PF
Output Capacitance	C_{oss}		-	18.3	36.6	
Reverse Transfer Capacitance	C_{rss}		-	7.4	14.8	
Drain-Source Diode Characteristics and Maximum Ratings						
Continuous Source Current	I_S	$V_G=V_D=0V,$ Force Current	-	-	400	mA
Pulsed Source Current	I_{SM}		-	-	800	
Diode Forward Voltage	V_{SD}	$V_{GS}=0V, I_S=0.2A,$ $T_J=25^\circ\text{C}$	-	-	1	V
Reverse Recovery Time	T_{rr}	$V_{GS}=0V, I_S=0.3A,$ $d_i/d_f=100A/\mu s,$	-	13	-	nS
Reverse Recovery Charge	Q_{rr}	$T_J=25^\circ\text{C}$	-	6	-	nC

Typical Electrical and Thermal Characteristic Curves

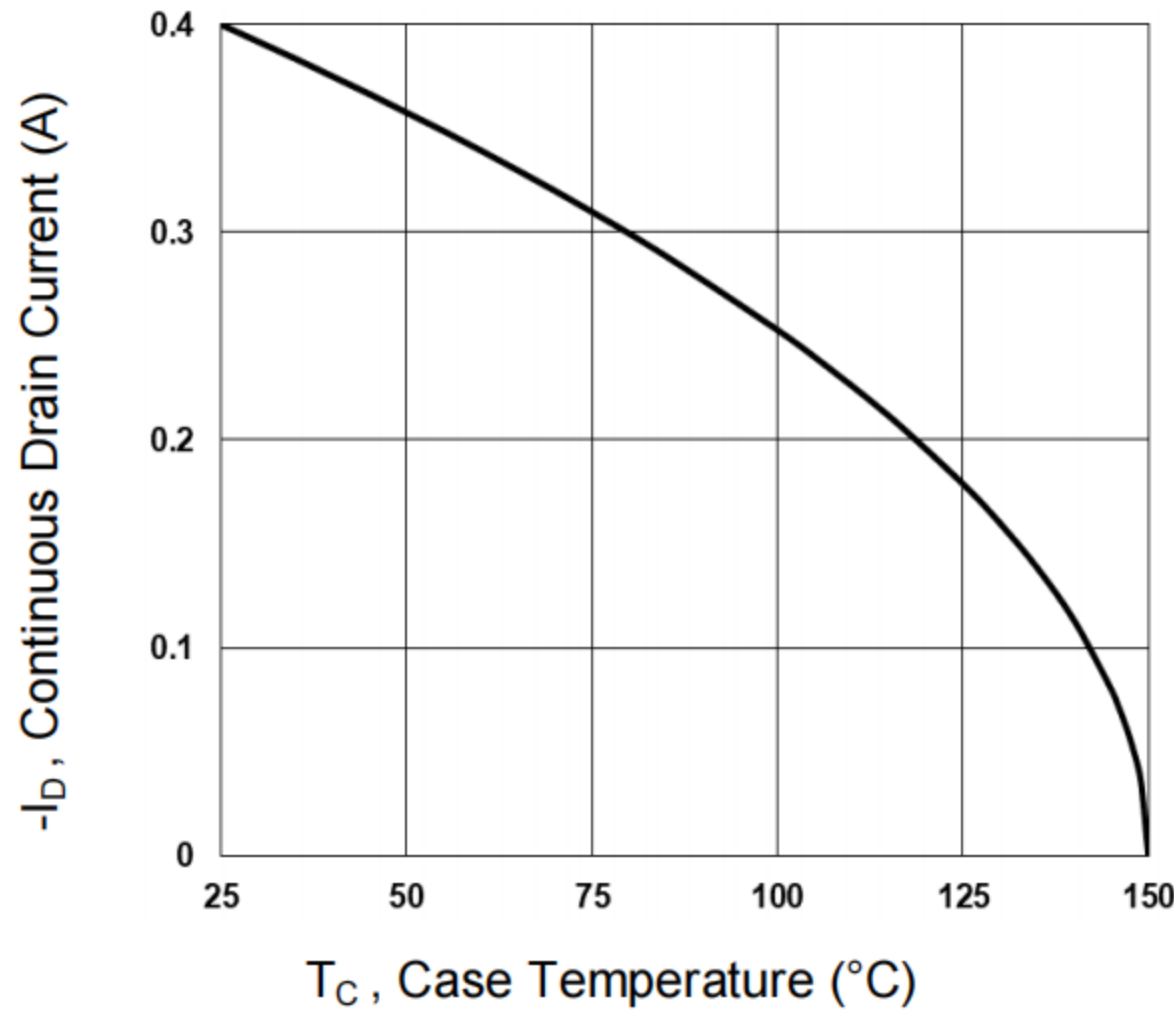

Figure 1. Continuous Drain Current vs. T_c

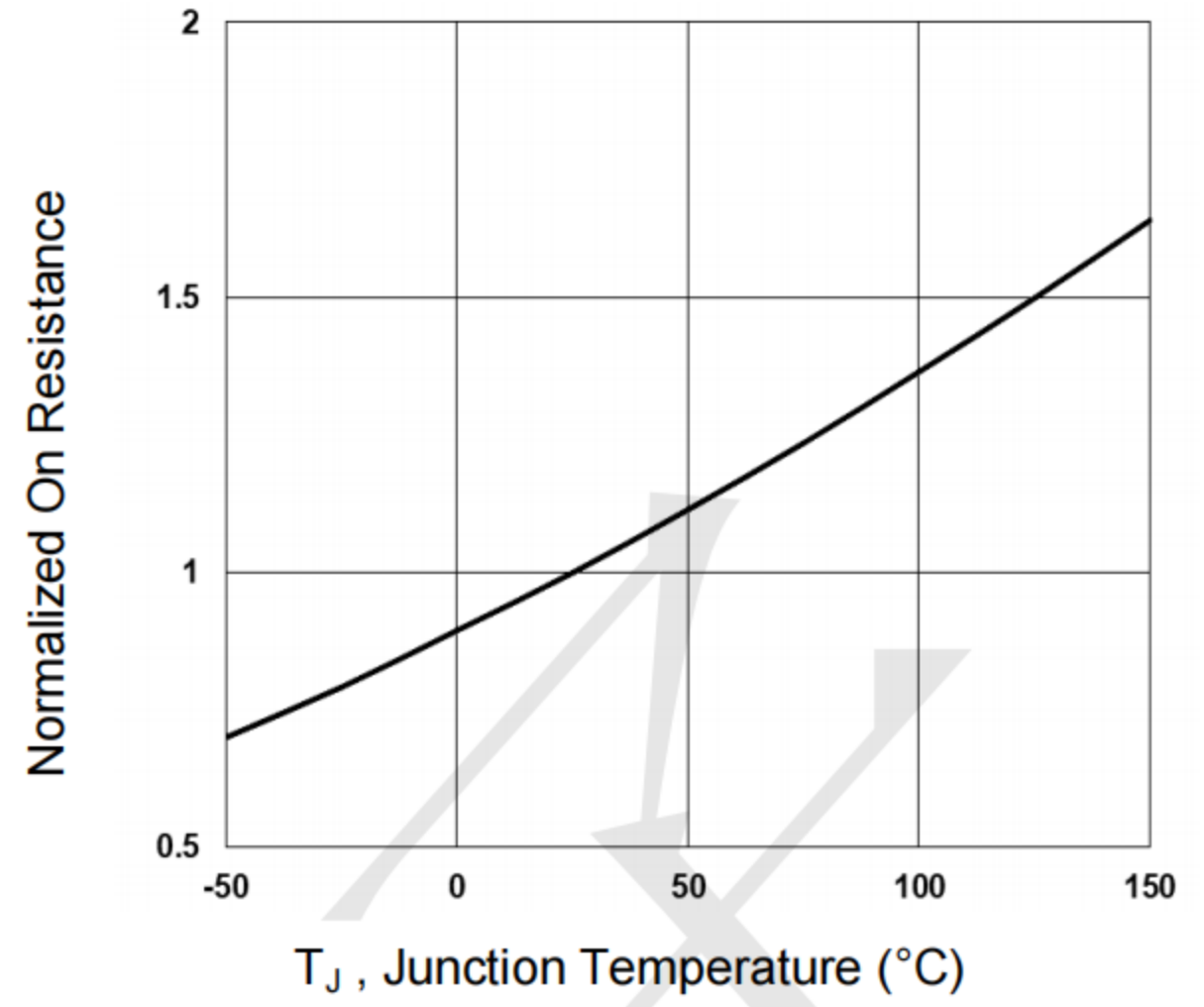

Figure 2. Normalized $R_{DS(on)}$ vs. T_j

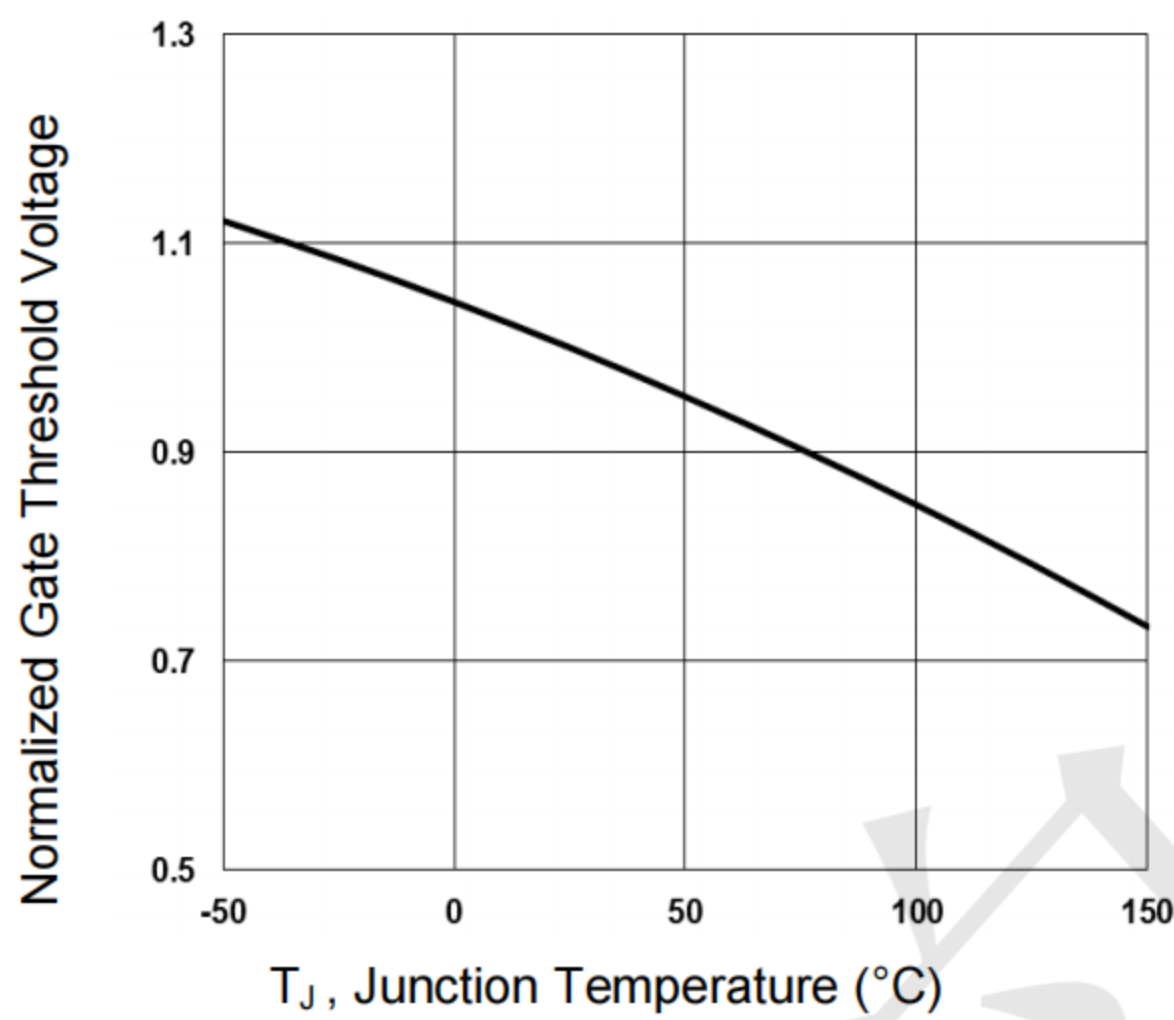

Figure 3. Normalized V_{th} vs. T_j

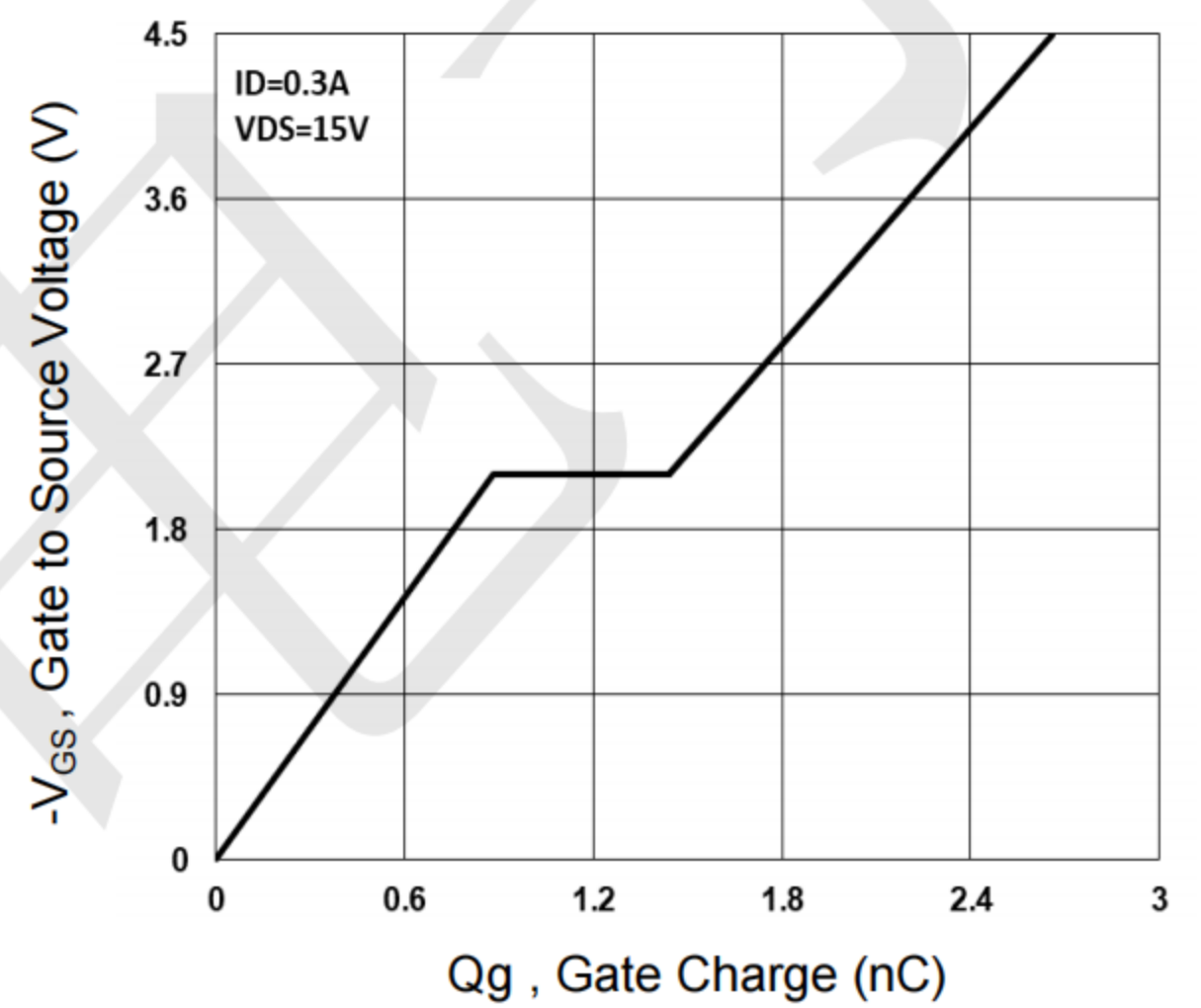

Figure 4. Gate Charge Waveform

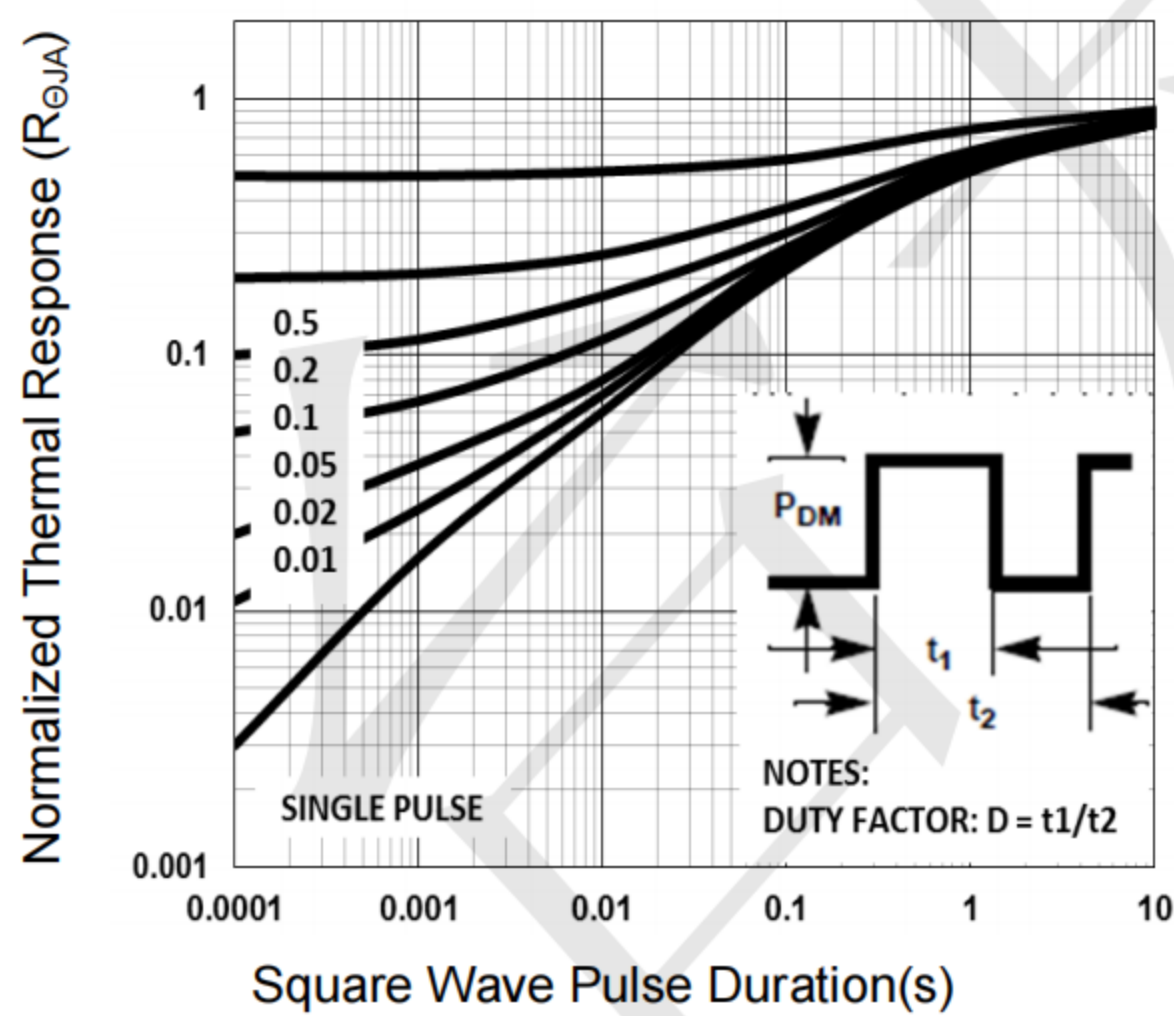

Figure 5. Normalized Transient Response

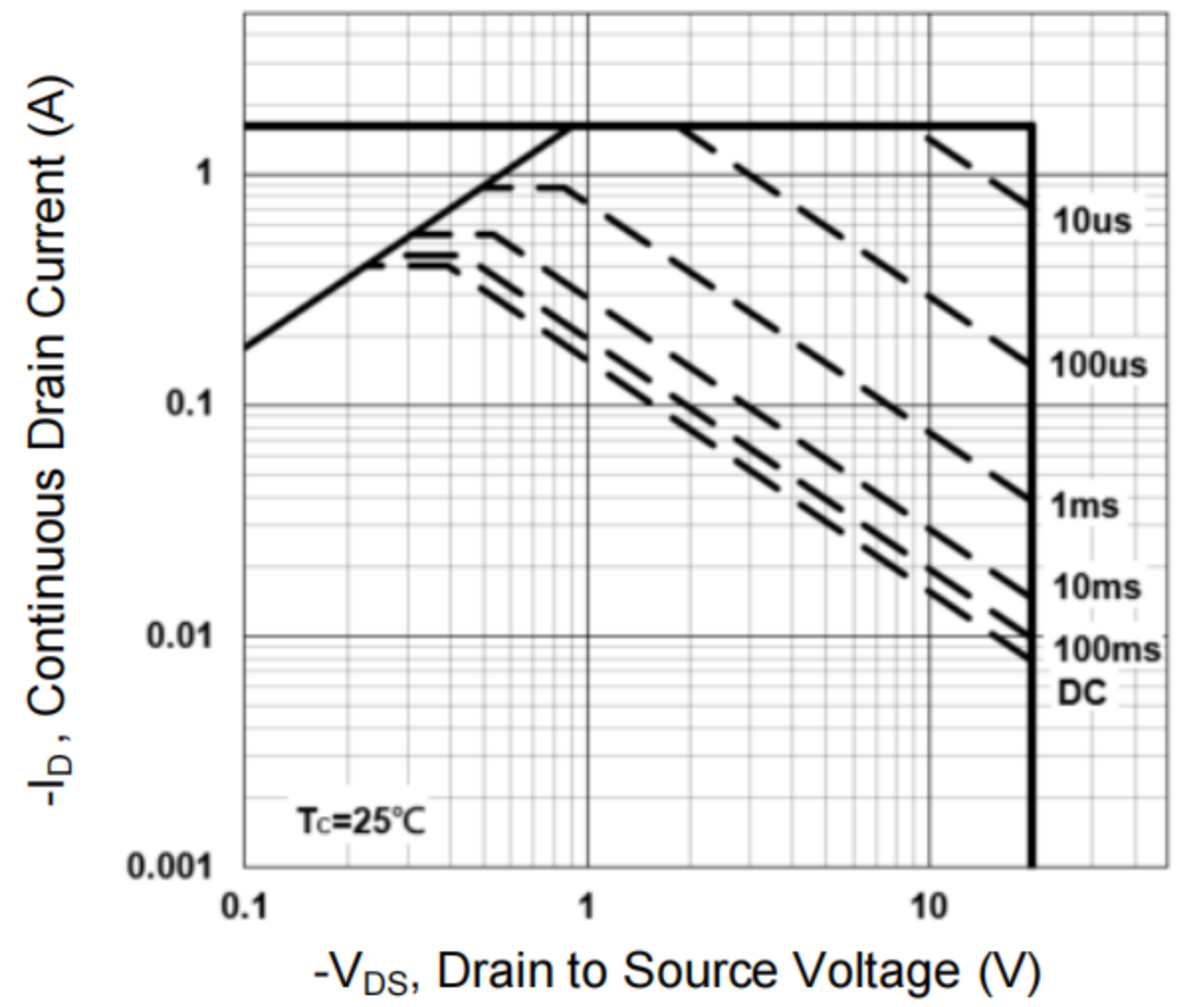

Figure 6. Maximum Safe Operation Area

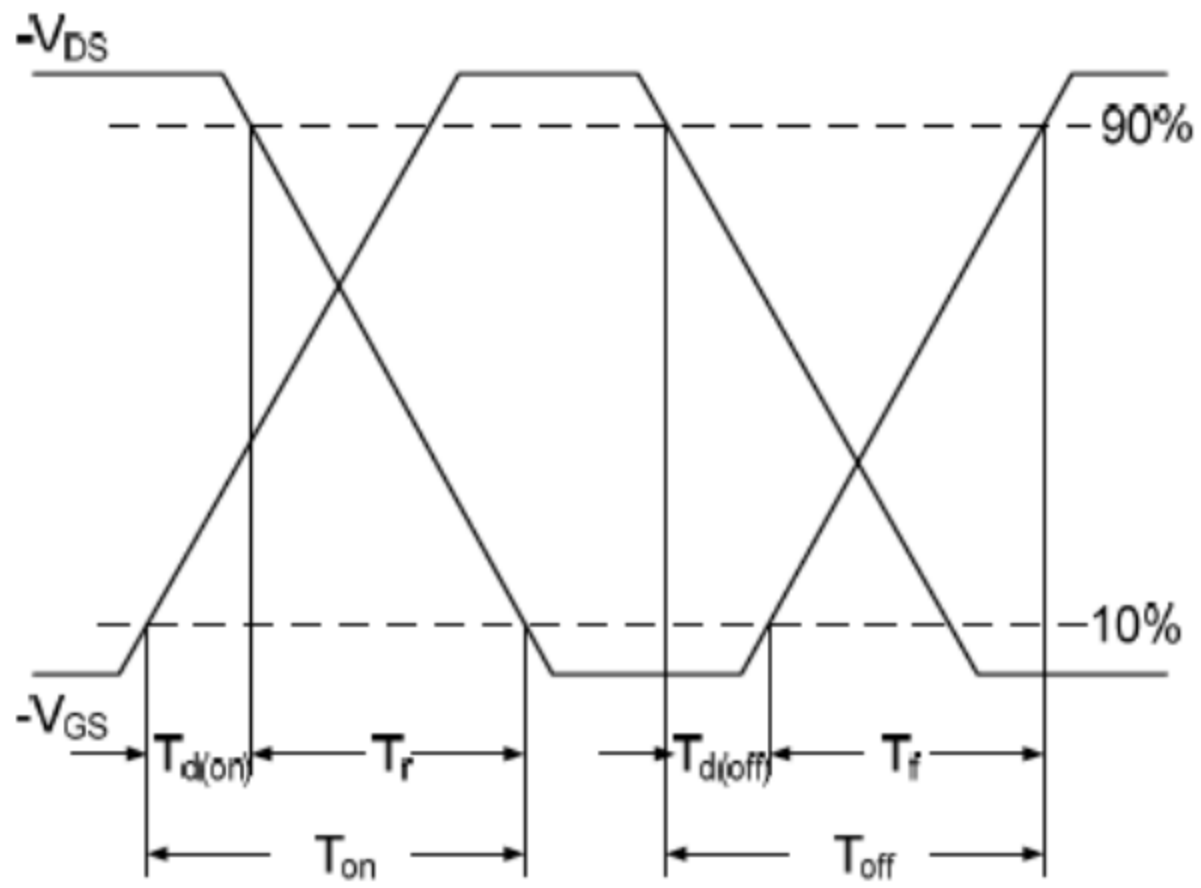

Figure 7. Switching Time Waveform

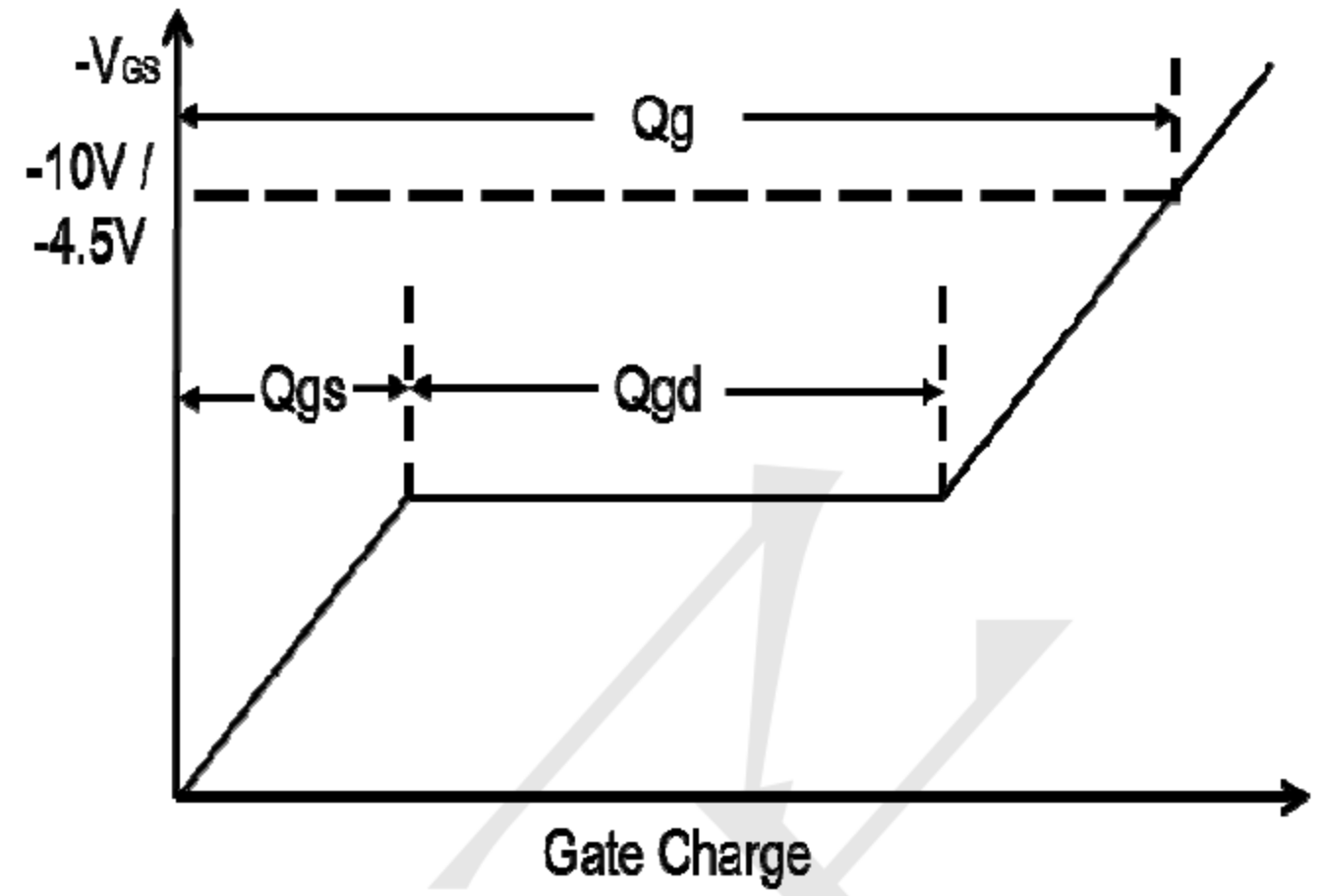
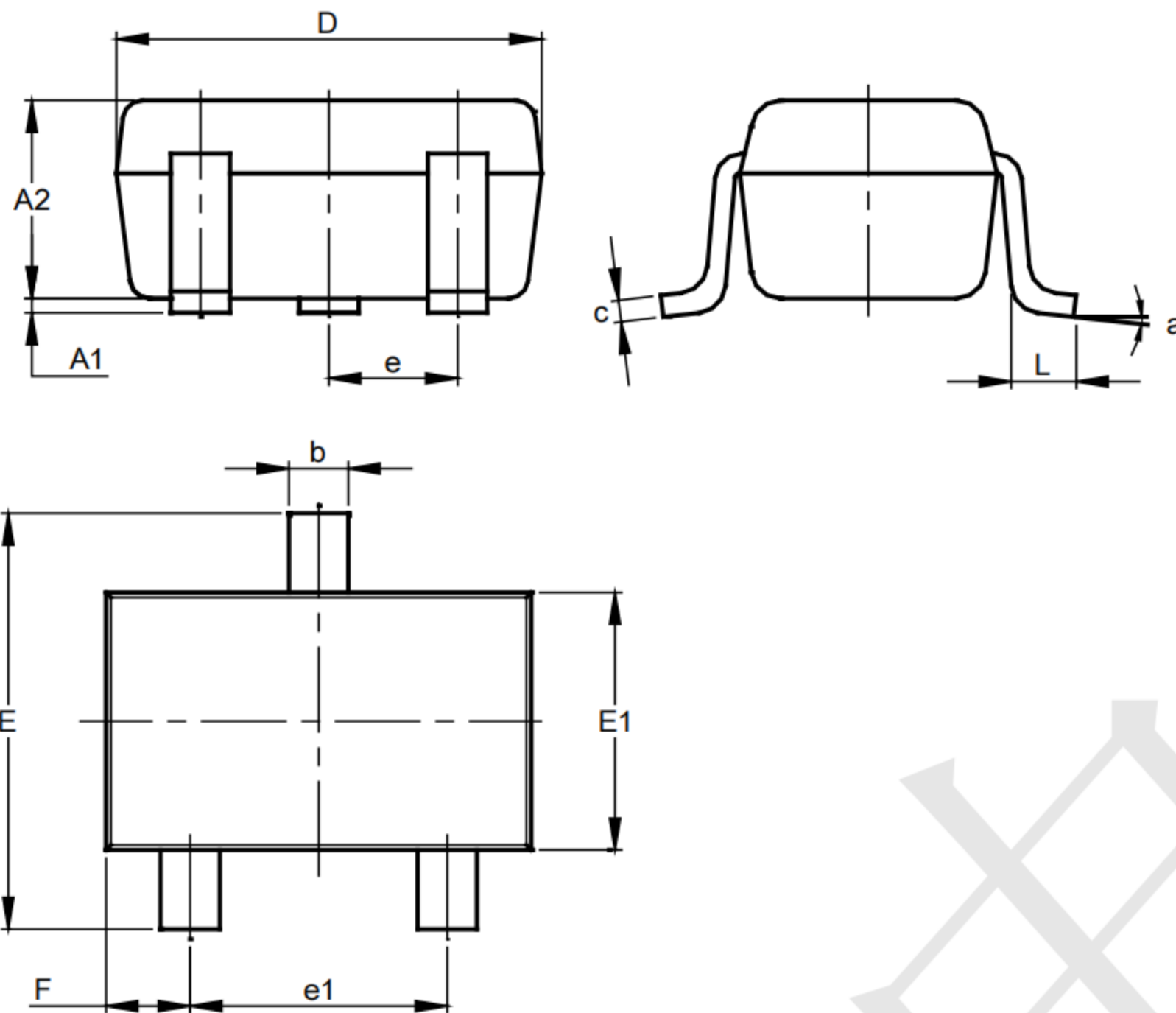

Figure 8. Gate Charge Waveform

Outline Drawing - SOT323(SC70-3)



SOT323			
Dim	Min	Max	Typ
A1	0.00	0.10	0.05
A2	0.90	1.00	0.95
b	0.25	0.40	0.30
c	0.10	0.18	0.11
D	1.80	2.20	2.15
E	2.00	2.20	2.10
E1	1.15	1.35	1.30
e	0.650 BSC		
e1	1.20	1.40	1.30
F	0.375	0.475	0.425
L	0.25	0.40	0.30
a	0°	8°	--
All Dimensions in mm			

Land Pattern - SOT323

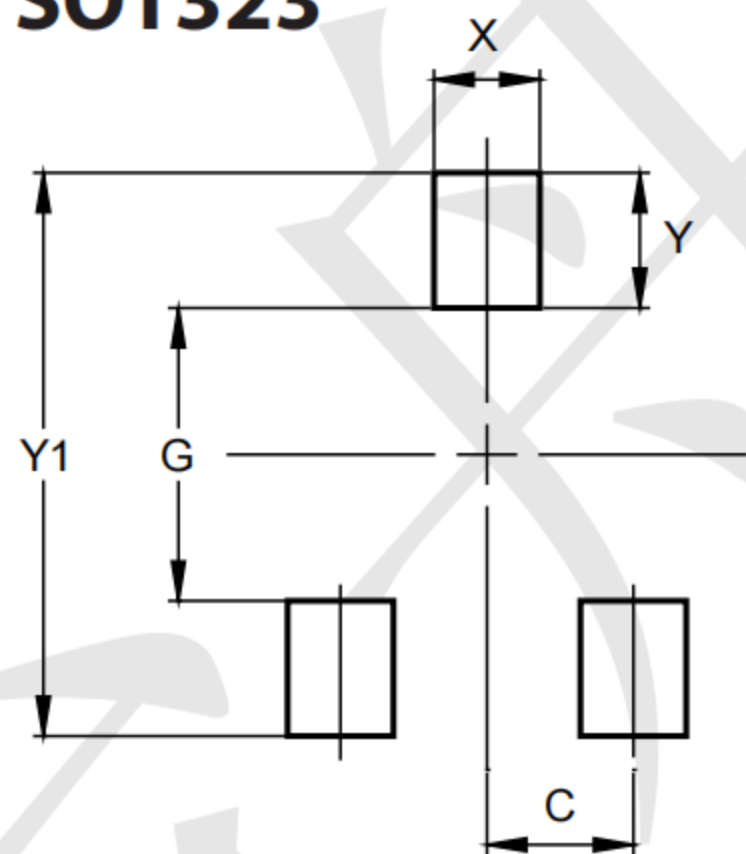

Dimensions	Value (in mm)
C	0.650
G	1.300
X	0.470
Y	0.600
Y1	2.500

X-ON Electronics

Largest Supplier of Electrical and Electronic Components

Click to view similar products for [MOSFET](#) category:

Click to view products by [TECH PUBLIC](#) manufacturer:

Other Similar products are found below :

[IRFD120](#) [JANTX2N5237](#) [2SK2267\(Q\)](#) [BUK455-60A/B](#) [TK100A10N1,S4X\(S](#) [MIC4420CM-TR](#) [VN1206L](#) [NDP4060](#) [SI4482DY](#)
[IRS2092STRPBF-EL](#) [IPS70R2K0CEAKMA1](#) [TK31J60W5,S1VQ\(O](#) [TK31J60W,S1VQ\(O](#) [TK16J60W,S1VQ\(O](#) [2SK2614\(TE16L1,Q\)](#)
[DMN1017UCP3-7](#) [EFC2J004NUZTDG](#) [P85W28HP2F-7071](#) [DMN1053UCP4-7](#) [NTE2384](#) [DMC2700UDMQ-7](#) [DMN2080UCB4-7](#)
[DMN61D9UWQ-13](#) [US6M2GTR](#) [DMN31D5UDJ-7](#) [DMP22D4UFO-7B](#) [IPS60R3K4CEAKMA1](#) [DMN1006UCA6-7](#) [DMN16M9UCA6-7](#)
[STF5N65M6](#) [IRF40H233XTMA1](#) [STU5N65M6](#) [DMN6022SSD-13](#) [DMN13M9UCA6-7](#) [DMTH10H4M6SPS-13](#) [IPS60R360PFD7SAKMA1](#)
[DMN2990UFB-7B](#) [SSM3K35CT,L3F](#) [IPLK60R1K0PFD7ATMA1](#) [2N7002W-G](#) [MCAC30N06Y-TP](#) [IPWS65R035CFD7AXKSA1](#)
[MCQ7328-TP](#) [SSM3J143TU,LXHF](#) [DMN12M3UCA6-7](#) [PJMF280N65E1_T0_00201](#) [PJMF380N65E1_T0_00201](#)
[PJMF280N60E1_T0_00201](#) [PJMF600N65E1_T0_00201](#) [PJMF900N65E1_T0_00201](#)